



**THE DATASHEET OF
LP3891ES-1.2**



LP3891 0.8A Fast-Response Ultra Low Dropout Linear Regulators

Check for Samples: [LP3891](#)

FEATURES

- Ultra Low Dropout Voltage (100mV at 0.8A typ)
- Low Ground Pin Current
- Load Regulation of 0.04%/A
- 60 nA Typical Quiescent Current in Shutdown
- 1.5% Output Accuracy (25°C)
- TO-220, DPAK/TO-263 and SO PowerPAD-8 Packages
- Over Temperature/Over Current Protection
- -40°C to +125°C Junction Temperature Range

APPLICATIONS

- DSP Power Supplies
- Server Core and I/O Supplies
- PC Add-in-Cards
- Local Regulators in Set-Top Boxes
- Microcontroller Power Supplies
- High Efficiency Power Supplies
- SMPS Post-Regulators

DESCRIPTION

The LP3891 is a high current, fast response regulator which can maintain output voltage regulation with minimum input to output voltage drop. Fabricated on a CMOS process, the device operates from two input voltages: V_{bias} provides voltage to drive the gate of the N-MOS power transistor, while V_{in} is the input voltage which supplies power to the load. The use of an external bias rail allows the part to operate from ultra low V_{in} voltages. Unlike bipolar regulators, the CMOS architecture consumes extremely low quiescent current at any output load current. The use of an N-MOS power transistor results in wide bandwidth, yet minimum external capacitance is required to maintain loop stability.

The fast transient response of these devices makes them suitable for use in powering DSP, Microcontroller Core voltages and Switch Mode Power Supply post regulators. The parts are available in TO-220, DPAK/TO-263 and SO PowerPAD-8 packages.

Dropout Voltage: 100 mV (typ) at 0.8A load current.

Ground Pin Current: 3 mA (typ) at full load.

Shutdown Current: 60 nA (typ) when S/D pin is low.

Precision Output Voltage: 1.5% room temperature accuracy.

TYPICAL APPLICATION CIRCUIT

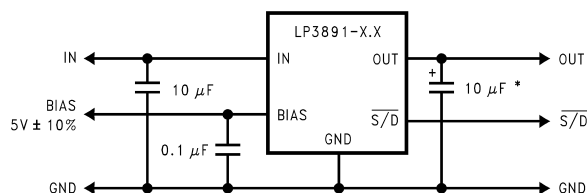

At least 10 µF of input and output capacitance is required for stability.

*Tantalum capacitors are recommended. Aluminum electrolytic capacitors may be used for restricted temperature range. See application hints.



Please be aware that an important notice concerning availability, standard warranty, and use in critical applications of Texas Instruments semiconductor products and disclaimers thereto appears at the end of this data sheet.

All trademarks are the property of their respective owners.



These devices have limited built-in ESD protection. The leads should be shorted together or the device placed in conductive foam during storage or handling to prevent electrostatic damage to the MOS gates.

CONNECTION DIAGRAM

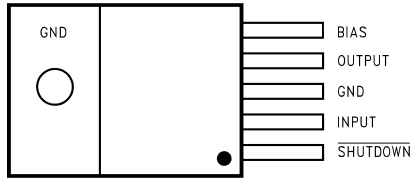

Figure 1. TO-220, Top View

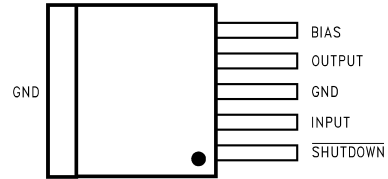

Figure 2. DDPAK/TO-263, Top View

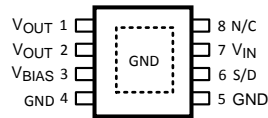

Figure 3. SO PowerPAD-8, Top View

BLOCK DIAGRAM



ABSOLUTE MAXIMUM RATINGS ⁽¹⁾

If Military/Aerospace specified devices are required, contact the Texas Instruments Sales Office/Distributors for availability and specifications.

	VALUE / UNITS
Storage Temperature Range	-65°C to +150°C
Lead Temp. (Soldering, 5 seconds)	260°C
ESD Rating Human Body Model ⁽²⁾ Machine Model ⁽³⁾	2 kV 200V
Power Dissipation ⁽⁴⁾	Internally Limited
V _{IN} Supply Voltage (Survival)	-0.3V to +6V
V _{BIAS} Supply Voltage (Survival)	-0.3V to +7V
Shutdown Input Voltage (Survival)	-0.3V to +7V
I _{OUT} (Survival)	Internally Limited
Output Voltage (Survival)	-0.3V to +6V
Junction Temperature	-40°C to +150°C

- (1) Absolute maximum ratings indicate limits beyond which damage to the component may occur. Operating ratings indicate conditions for which the device is intended to be functional, but do **not** ensure specific performance limits. For specifications, see Electrical Characteristics. Specifications do not apply when operating the device outside of its rated operating conditions.
- (2) The human body model is a 100 pF capacitor discharged through a 1.5k resistor into each pin.
- (3) The machine model is a 220 pF capacitor discharged directly into each pin. The machine model ESD rating of pin 5 is 100V.
- (4) At elevated temperatures, device power dissipation must be derated based on package thermal resistance and heatsink thermal values. θ_{J-A} for TO-220 devices is 65°C/W if no heatsink is used. If the TO-220 device is attached to a heatsink, a θ_{J-S} value of 4°C/W can be assumed. θ_{J-A} for TO-263 devices is approximately 40°C/W if soldered down to a copper plane which is at least 1.5 square inches in area. θ_{J-A} value for typical SO PowerPAD-8 PC board mounting is 166°C/W. If power dissipation causes the junction temperature to exceed specified limits, the device will go into thermal shutdown.

RECOMMENDED OPERATING CONDITIONS

	VALUE / UNITS
V _{IN}	(V _{OUT} + V _{DO}) to 5.5V
Shutdown	0 to +6V
I _{OUT}	0.8A
Junction Temperature	-40°C to +125°C
V _{BIAS}	4.5V to 6V

ELECTRICAL CHARACTERISTICS

Limits in standard typeface are for $T_J = 25^\circ\text{C}$, and limits in **boldface type** apply over the full operating temperature range. Unless otherwise specified: $V_{IN} = V_O(\text{NOM}) + 1\text{V}$, $V_{BIAS} = 4.5\text{V}$, $I_L = 10\text{ mA}$, $C_{IN} = C_{OUT} = 10\ \mu\text{F}$, $V_{S/D} = V_{BIAS}$.

Symbol	Parameter	Conditions	MIN ⁽¹⁾	Typical ⁽²⁾	MAX ⁽¹⁾	Units
V_O	Output Voltage Tolerance	$10\text{ mA} \leq I_L \leq 0.8\text{A}$, $V_O(\text{NOM}) + 1\text{V} \leq V_{IN} \leq 5.5\text{V}$, $4.5\text{V} \leq V_{BIAS} \leq 6\text{V}$	1.198 1.186	1.216	1.234 1.246	V
			1.478 1.455	1.5	1.522 1.545	
			1.773 1.746	1.8	1.827 1.854	
$\Delta V_O/\Delta V_{IN}$	Output Voltage Line Regulation ⁽³⁾	$V_O(\text{NOM}) + 1\text{V} \leq V_{IN} \leq 5.5\text{V}$		0.01		%/V
$\Delta V_O/\Delta I_L$	Output Voltage Load Regulation ⁽⁴⁾ ⁽⁵⁾	$10\text{ mA} \leq I_L \leq 0.8\text{A}$		0.04 0.06		%/A
V_{DO}	Dropout Voltage ⁽⁶⁾	$I_L = 0.8\text{A}$ (TO220 and TO263 only)		100	300 400	mV
		$I_L = 0.8\text{A}$ (SO PowerPAD only)		115	320 430	
$I_Q(V_{IN})$	Quiescent Current Drawn from V_{IN} Supply	$10\text{ mA} \leq I_L \leq 0.8\text{A}$		3	7 8	mA
		$\overline{V_{S/D}} \leq 0.3\text{V}$		0.03	1 30	
$I_Q(V_{BIAS})$	Quiescent Current Drawn from V_{BIAS} Supply	$10\text{ mA} \leq I_L \leq 0.8\text{A}$		1	2 3	mA
		$\overline{V_{S/D}} \leq 0.3\text{V}$		0.03	1 30	
I_{SC}	Short-Circuit Current	$V_{OUT} = 0\text{V}$		2.5		A
Shutdown Input						
V_{SDT}	Output Turn-off Threshold	Output = ON	1.3	0.7		V
		Output = OFF		0.7	0.3	
$T_d(\text{OFF})$	Turn-OFF Delay	$R_{LOAD} \times C_{OUT} \ll T_d(\text{OFF})$		20		μs
$T_d(\text{ON})$	Turn-ON Delay	$R_{LOAD} \times C_{OUT} \ll T_d(\text{ON})$		15		
$\overline{I_{S/D}}$	$\overline{S/D}$ Input Current	$\overline{V_{S/D}} = 1.3\text{V}$		1		μA
		$\overline{V_{S/D}} \leq 0.3\text{V}$		-1		
AC Parameters						
PSRR (V_{IN})	Ripple Rejection for V_{IN} Input Voltage	$V_{IN} = V_{OUT} + 1\text{V}$, $f = 120\text{ Hz}$		80		dB
		$V_{IN} = V_{OUT} + 1\text{V}$, $f = 1\text{ kHz}$		65		
PSRR (V_{BIAS})	Ripple Rejection for V_{BIAS} Voltage	$V_{BIAS} = V_{OUT} + 3\text{V}$, $f = 120\text{ Hz}$		70		
		$V_{BIAS} = V_{OUT} + 3\text{V}$, $f = 1\text{ kHz}$		65		
	Output Noise Density	$f = 120\text{ Hz}$		1		$\mu\text{V}/\text{root-Hz}$
e_n	Output Noise Voltage	$\text{BW} = 10\text{ Hz} - 100\text{ kHz}$, $V_{OUT} = 1.8\text{V}$		150		μV (rms)
		$\text{BW} = 300\text{ Hz} - 300\text{ kHz}$, $V_{OUT} = 1.8\text{V}$		90		

- (1) Limits are specified through testing, statistical correlation, or design.
- (2) Typical numbers represent the most likely parametric norm for 25°C operation.
- (3) Output voltage line regulation is defined as the change in output voltage from nominal value resulting from a change in input voltage.
- (4) If used in a dual-supply system where the regulator load is returned to a negative supply, the output pin must be diode clamped to ground.
- (5) Output voltage load regulation is defined as the change in output voltage from nominal value as the load current increases from no load to full load.
- (6) Dropout voltage is defined as the minimum input to output differential required to maintain the output with 2% of nominal value. The SO PowerPAD-8 package devices have a slightly higher dropout voltage due to increased bond wire resistance.

TYPICAL PERFORMANCE CHARACTERISTICS

Unless otherwise specified: $T_J = 25^\circ\text{C}$, $C_{OUT} = 10\ \mu\text{F}$, $C_{in} = 10\ \mu\text{F}$, $\overline{S/D}$ pin is tied to V_{BIAS} , $V_{IN} = 2.2\text{V}$, $V_{OUT} = 1.8\text{V}$

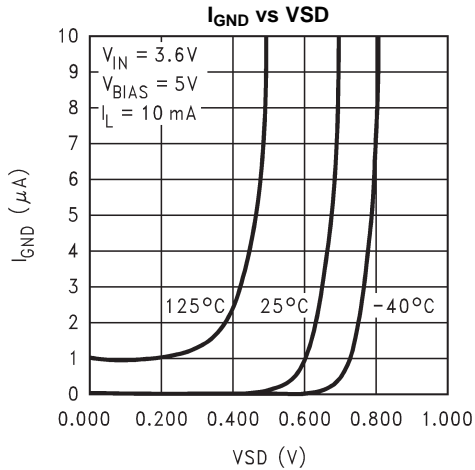

Figure 4.

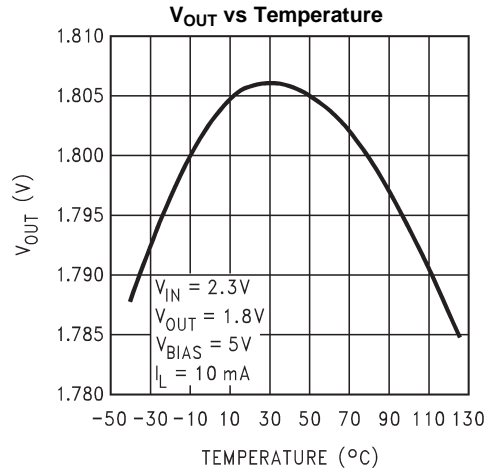

Figure 5.

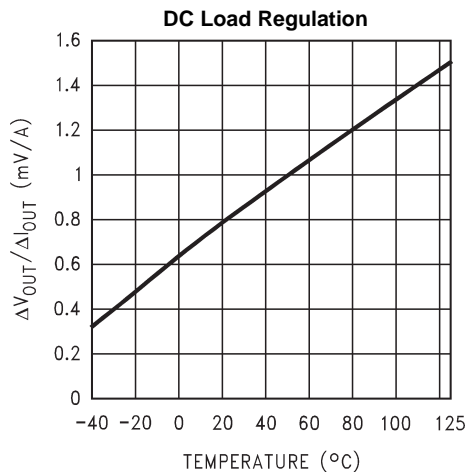

Figure 6.

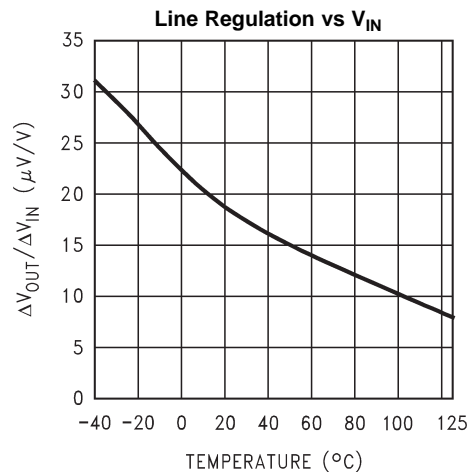

Figure 7.

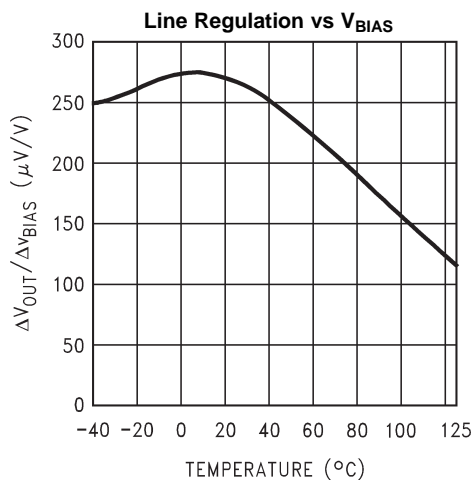

Figure 8.

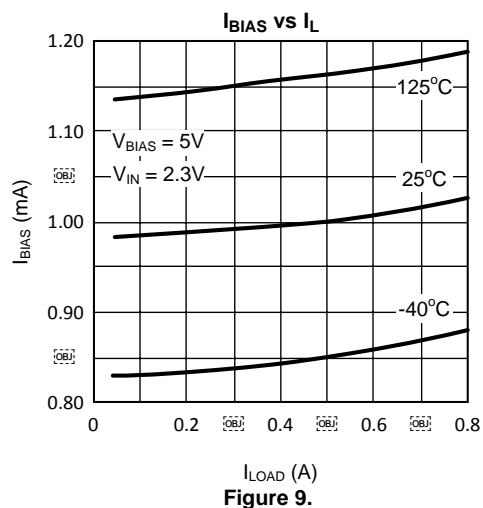

Figure 9.

TYPICAL PERFORMANCE CHARACTERISTICS (continued)

Unless otherwise specified: $T_J = 25^\circ\text{C}$, $C_{OUT} = 10\ \mu\text{F}$, $C_{in} = 10\ \mu\text{F}$, $\overline{S/D}$ pin is tied to V_{BIAS} , $V_{IN} = 2.2\text{V}$, $V_{OUT} = 1.8\text{V}$

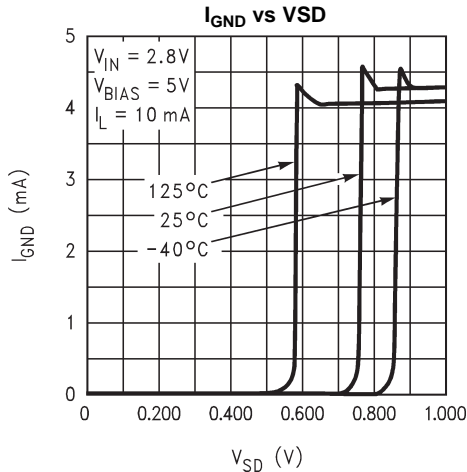

Figure 10.

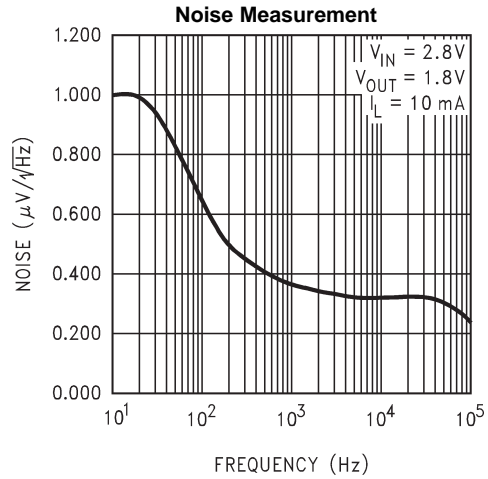

Figure 11.

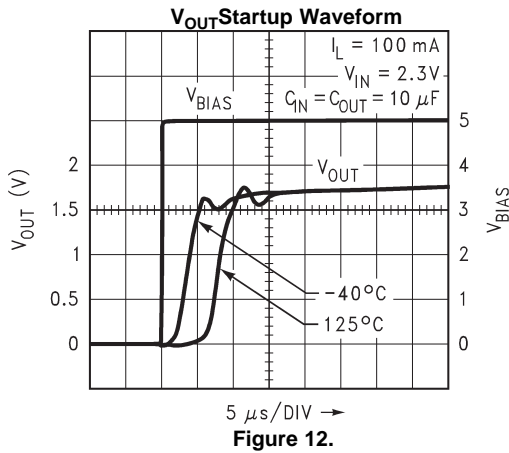

Figure 12.

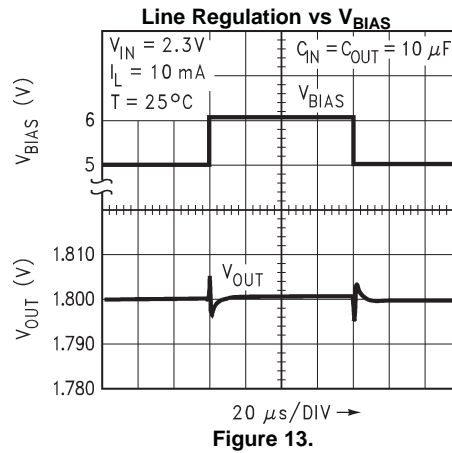

Figure 13.

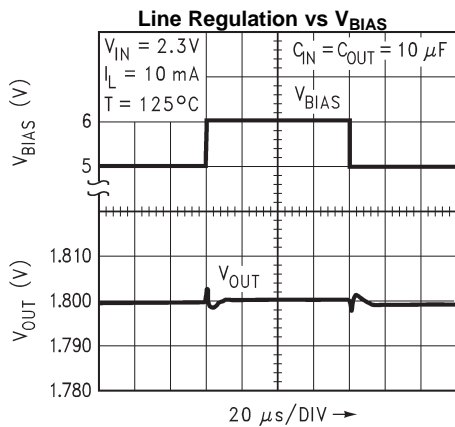

Figure 14.

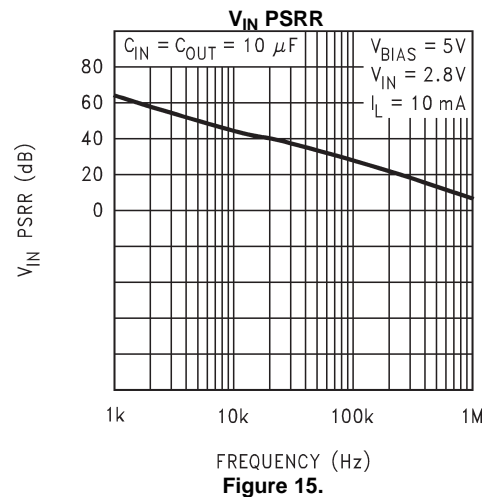

Figure 15.

TYPICAL PERFORMANCE CHARACTERISTICS (continued)

Unless otherwise specified: $T_J = 25^\circ\text{C}$, $C_{OUT} = 10 \mu\text{F}$, $C_{in} = 10\mu\text{F}$, $\overline{\text{S/D}}$ pin is tied to V_{BIAS} , $V_{IN} = 2.2\text{V}$, $V_{OUT} = 1.8\text{V}$

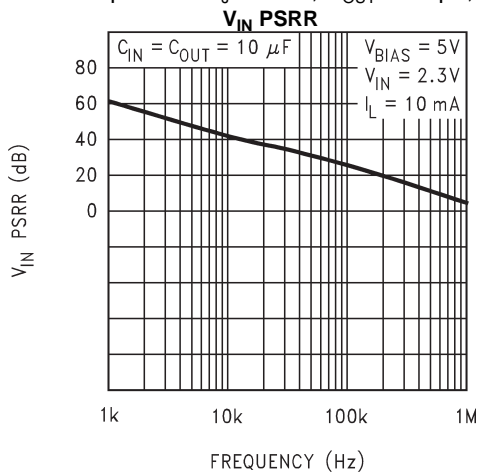

Figure 16.

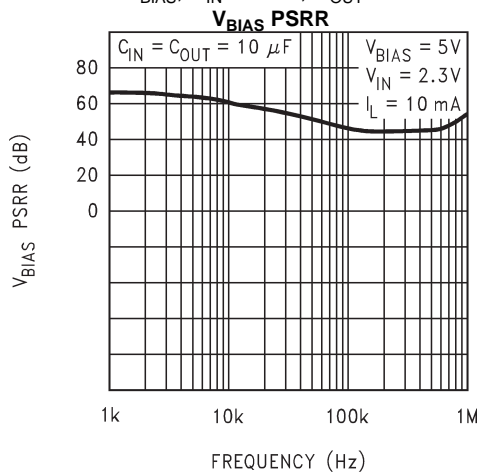

Figure 17.

Application Hints

EXTERNAL CAPACITORS

To assure regulator stability, input and output capacitors are required as shown in the Typical Application Circuit.

OUTPUT CAPACITOR

At least 10 μ F of output capacitance is required for stability (the amount of capacitance can be increased without limit). The output capacitor must be located less than 1cm from the output pin of the IC and returned to a clean analog ground. The ESR (equivalent series resistance) of the output capacitor must be within the "stable" range as shown in the graph below over the full operating temperature range for stable operation.

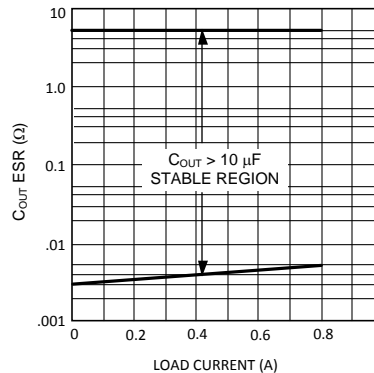

Figure 18. Minimum ESR vs Output Load Current

Tantalum capacitors are recommended for the output as their ESR is ideally suited to the part's requirements and the ESR is very stable over temperature. Aluminum electrolytics are not recommended because their ESR increases very rapidly at temperatures below 10°C. Aluminum caps can only be used in applications where lower temperature operation is not required.

A second problem with Al caps is that many have ESR's which are only specified at low frequencies. The typical loop bandwidth of a linear regulator is a few hundred kHz to several MHz. If an Al cap is used for the output cap, it must be one whose ESR is specified at a frequency of 100 kHz or more.

Because the ESR of ceramic capacitors is only a few milli Ohms, they are not suitable for use as output capacitors on LP389X devices. The regulator output can tolerate ceramic capacitance totaling up to 15% of the amount of Tantalum capacitance connected from the output to ground.

INPUT CAPACITOR

The input capacitor must be at least 10 μ F, but can be increased without limit. Its purpose is to provide a low source impedance for the regulator input. Ceramic capacitors work best for this, but Tantalums are also very good. There is no ESR limitation on the input capacitor (the lower, the better). Aluminum electrolytics can be used, but their ESR increase very quickly at cold temperatures. They are not recommended for any application where temperatures go below about 10°C.

BIAS CAPACITOR

The 0.1 μ F capacitor on the bias line can be any good quality capacitor (ceramic is recommended).

BIAS VOLTAGE

The bias voltage is an external voltage rail required to get gate drive for the N-FET pass transistor. Bias voltage must be in the range of 4.5 - 6V to assure proper operation of the part.

UNDER VOLTAGE LOCKOUT

The bias voltage is monitored by a circuit which prevents the regulator output from turning on if the bias voltage is below approximately 4V.

SHUTDOWN OPERATION

Pulling down the shutdown ($\overline{S/D}$) pin will turn-off the regulator. Pin $\overline{S/D}$ must be actively terminated through a pull-up resistor (10 k Ω to 100 k Ω) for a proper operation. If this pin is driven from a source that actively pulls high and low (such as a CMOS rail to rail comparator), the pull-up resistor is not required. This pin must be tied to Vin if not used.

POWER DISSIPATION/HEATSINKING

A heatsink may be required depending on the maximum power dissipation and maximum ambient temperature of the application. Under all possible conditions, the junction temperature must be within the range specified under operating conditions. The total power dissipation of the device is given by:

$$P_D = (V_{IN} - V_{OUT})I_{OUT} + (V_{IN})I_{GND} \quad (1)$$

where I_{GND} is the operating ground current of the device.

The maximum allowable temperature rise (T_{Rmax}) depends on the maximum ambient temperature (T_{Amax}) of the application, and the maximum allowable junction temperature (T_{Jmax}):

$$T_{Rmax} = T_{Jmax} - T_{Amax} \quad (2)$$

The maximum allowable value for junction to ambient Thermal Resistance, θ_{JA} , can be calculated using the formula:

$$\theta_{JA} = T_{Rmax} / P_D \quad (3)$$

These parts are available in TO-220 and DDPAK/TO-263 packages. The thermal resistance depends on amount of copper area or heat sink, and on air flow. If the maximum allowable value of θ_{JA} calculated above is ≥ 60 °C/W for TO-220 package and ≥ 60 °C/W for DDPAK/TO-263 package no heatsink is needed since the package can dissipate enough heat to satisfy these requirements. If the value for allowable θ_{JA} falls below these limits, a heat sink is required.

HEATSINKING TO-220 PACKAGE

The thermal resistance of a TO-220 package can be reduced by attaching it to a heat sink or a copper plane on a PC board. If a copper plane is to be used, the values of θ_{JA} will be same as shown in next section for DDPAK/TO-263 package.

The heatsink to be used in the application should have a heatsink to ambient thermal resistance,

$$\theta_{HA} \leq \theta_{JA} - \theta_{CH} - \theta_{JC} \quad (4)$$

In this equation, θ_{CH} is the thermal resistance from the case to the surface of the heat sink and θ_{JC} is the thermal resistance from the junction to the surface of the case. θ_{JC} is about 3°C/W for a TO220 package. The value for θ_{CH} depends on method of attachment, insulator, etc. θ_{CH} varies between 1.5°C/W to 2.5°C/W. If the exact value is unknown, 2°C/W can be assumed.

HEATSINKING DDPAK/TO-263 PACKAGE

The DDPAK/TO-263 package uses the copper plane on the PCB as a heatsink. The tab of these packages are soldered to the copper plane for heat sinking. [Figure 19](#) shows a curve for the θ_{JA} of DDPAK/TO-263 package for different copper area sizes, using a typical PCB with 1 ounce copper and no solder mask over the copper area for heat sinking.

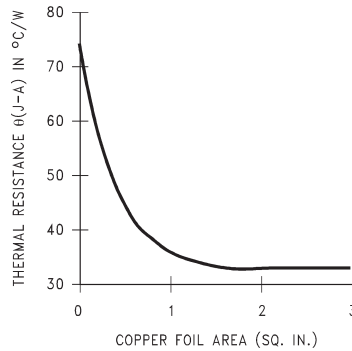

Figure 19. θ_{JA} vs Copper (1 Ounce) Area for DDPAK/TO-263 Package

As shown in [Figure 20](#), increasing the copper area beyond 1 square inch produces very little improvement. The minimum value for θ_{JA} for the DDPAK/TO-263 package mounted to a PCB is 32°C/W.

[Figure 20](#) shows the maximum allowable power dissipation for DDPAK/TO-263 packages for different ambient temperatures, assuming θ_{JA} is 35°C/W and the maximum junction temperature is 125°C.

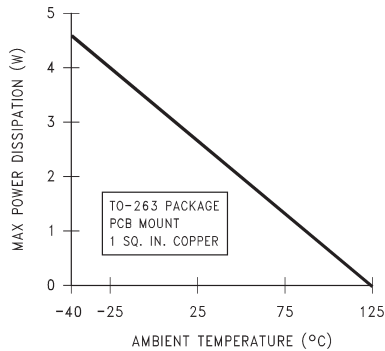

Figure 20. Maximum Power Dissipation vs Ambient Temperature for DDPAK/TO-263 Package

HEATSINKING SO PowerPAD PACKAGE

Heatsinking for the SO PowerPAD-8 package is accomplished by allowing heat to flow through the ground slug on the bottom of the package into the copper on the PC board. The heat slug must be soldered down to a copper plane to get good heat transfer. It can also be connected through vias to internal copper planes. Since the heat slug is at ground potential, traces must not be routed under it which are not at ground potential. Under all possible conditions, the junction temperature must be within the range specified under operating conditions.

[Figure 21](#) shows a curve for the θ_{JA} of the SO PowerPAD package for different copper area sizes using a typical PCB with one ounce copper in still air.

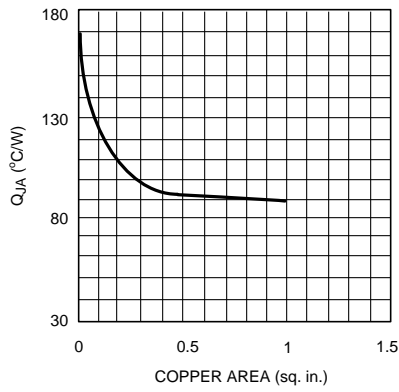

Figure 21. θ_{JA} vs Copper (1 ounce) Area for SO PowerPAD Package

REVISION HISTORY

Changes from Revision C (April 2013) to Revision D	Page
• Changed layout of National Data Sheet to TI format	11

PACKAGING INFORMATION

Orderable Device	Status (1)	Package Type	Package Drawing	Pins	Package Qty	Eco Plan (2)	Lead/Ball Finish (6)	MSL Peak Temp (3)	Op Temp (°C)	Device Marking (4/5)	Samples
LP3891EMR-1.2	NRND	SO PowerPAD	DDA	8	95	TBD	Call TI	Call TI	-40 to 125	3891E MR1.2	
LP3891EMR-1.2/NOPB	ACTIVE	SO PowerPAD	DDA	8	95	Green (RoHS & no Sb/Br)	CU SN	Level-3-260C-168 HR	-40 to 125	3891E MR1.2	Samples
LP3891EMR-1.8/NOPB	ACTIVE	SO PowerPAD	DDA	8	95	Green (RoHS & no Sb/Br)	CU SN	Level-3-260C-168 HR	-40 to 125	3891E MR1.8	Samples
LP3891EMRX-1.2/NOPB	ACTIVE	SO PowerPAD	DDA	8	2500	Green (RoHS & no Sb/Br)	CU SN	Level-3-260C-168 HR	-40 to 125	3891E MR1.2	Samples
LP3891ES-1.2	NRND	DDPAK/ TO-263	KTT	5	45	TBD	Call TI	Call TI	-40 to 125	LP3891ES -1.2	
LP3891ES-1.2/NOPB	ACTIVE	DDPAK/ TO-263	KTT	5	45	Pb-Free (RoHS Exempt)	CU SN	Level-3-245C-168 HR	-40 to 125	LP3891ES -1.2	Samples
LP3891ES-1.5/NOPB	ACTIVE	DDPAK/ TO-263	KTT	5	45	Pb-Free (RoHS Exempt)	CU SN	Level-3-245C-168 HR	-40 to 125	LP3891ES -1.5	Samples
LP3891ESX-1.2/NOPB	ACTIVE	DDPAK/ TO-263	KTT	5	500	Pb-Free (RoHS Exempt)	CU SN	Level-3-245C-168 HR	-40 to 125	LP3891ES -1.2	Samples
LP3891ESX-1.5/NOPB	ACTIVE	DDPAK/ TO-263	KTT	5	500	Pb-Free (RoHS Exempt)	CU SN	Level-3-245C-168 HR	-40 to 125	LP3891ES -1.5	Samples

(1) The marketing status values are defined as follows:

ACTIVE: Product device recommended for new designs.

LIFEBUY: TI has announced that the device will be discontinued, and a lifetime-buy period is in effect.

NRND: Not recommended for new designs. Device is in production to support existing customers, but TI does not recommend using this part in a new design.

PREVIEW: Device has been announced but is not in production. Samples may or may not be available.

OBSOLETE: TI has discontinued the production of the device.

(2) Eco Plan - The planned eco-friendly classification: Pb-Free (RoHS), Pb-Free (RoHS Exempt), or Green (RoHS & no Sb/Br) - please check <http://www.ti.com/productcontent> for the latest availability information and additional product content details.

TBD: The Pb-Free/Green conversion plan has not been defined.

Pb-Free (RoHS): TI's terms "Lead-Free" or "Pb-Free" mean semiconductor products that are compatible with the current RoHS requirements for all 6 substances, including the requirement that lead not exceed 0.1% by weight in homogeneous materials. Where designed to be soldered at high temperatures, TI Pb-Free products are suitable for use in specified lead-free processes.

Pb-Free (RoHS Exempt): This component has a RoHS exemption for either 1) lead-based flip-chip solder bumps used between the die and package, or 2) lead-based die adhesive used between the die and leadframe. The component is otherwise considered Pb-Free (RoHS compatible) as defined above.

Green (RoHS & no Sb/Br): TI defines "Green" to mean Pb-Free (RoHS compatible), and free of Bromine (Br) and Antimony (Sb) based flame retardants (Br or Sb do not exceed 0.1% by weight in homogeneous material)

- (3) MSL, Peak Temp. - The Moisture Sensitivity Level rating according to the JEDEC industry standard classifications, and peak solder temperature.
- (4) There may be additional marking, which relates to the logo, the lot trace code information, or the environmental category on the device.
- (5) Multiple Device Markings will be inside parentheses. Only one Device Marking contained in parentheses and separated by a "~" will appear on a device. If a line is indented then it is a continuation of the previous line and the two combined represent the entire Device Marking for that device.
- (6) Lead/Ball Finish - Orderable Devices may have multiple material finish options. Finish options are separated by a vertical ruled line. Lead/Ball Finish values may wrap to two lines if the finish value exceeds the maximum column width.

Important Information and Disclaimer:The information provided on this page represents TI's knowledge and belief as of the date that it is provided. TI bases its knowledge and belief on information provided by third parties, and makes no representation or warranty as to the accuracy of such information. Efforts are underway to better integrate information from third parties. TI has taken and continues to take reasonable steps to provide representative and accurate information but may not have conducted destructive testing or chemical analysis on incoming materials and chemicals. TI and TI suppliers consider certain information to be proprietary, and thus CAS numbers and other limited information may not be available for release.

In no event shall TI's liability arising out of such information exceed the total purchase price of the TI part(s) at issue in this document sold by TI to Customer on an annual basis.

TAPE AND REEL INFORMATION



QUADRANT ASSIGNMENTS FOR PIN 1 ORIENTATION IN TAPE



*All dimensions are nominal

Device	Package Type	Package Drawing	Pins	SPQ	Reel Diameter (mm)	Reel Width W1 (mm)	A0 (mm)	B0 (mm)	K0 (mm)	P1 (mm)	W (mm)	Pin1 Quadrant
LP3891EMRX-1.2/NOPB	SO Power PAD	DDA	8	2500	330.0	12.4	6.5	5.4	2.0	8.0	12.0	Q1
LP3891ESX-1.2/NOPB	DDPAK/TO-263	KTT	5	500	330.0	24.4	10.75	14.85	5.0	16.0	24.0	Q2
LP3891ESX-1.5/NOPB	DDPAK/TO-263	KTT	5	500	330.0	24.4	10.75	14.85	5.0	16.0	24.0	Q2

TAPE AND REEL BOX DIMENSIONS

*All dimensions are nominal

Device	Package Type	Package Drawing	Pins	SPQ	Length (mm)	Width (mm)	Height (mm)
LP3891EMRX-1.2/NOPB	SO PowerPAD	DDA	8	2500	367.0	367.0	35.0
LP3891ESX-1.2/NOPB	DDPAK/TO-263	KTT	5	500	367.0	367.0	45.0
LP3891ESX-1.5/NOPB	DDPAK/TO-263	KTT	5	500	367.0	367.0	45.0

DDA0008B



PACKAGE OUTLINE

PowerPAD™ SOIC - 1.7 mm max height

PLASTIC SMALL OUTLINE

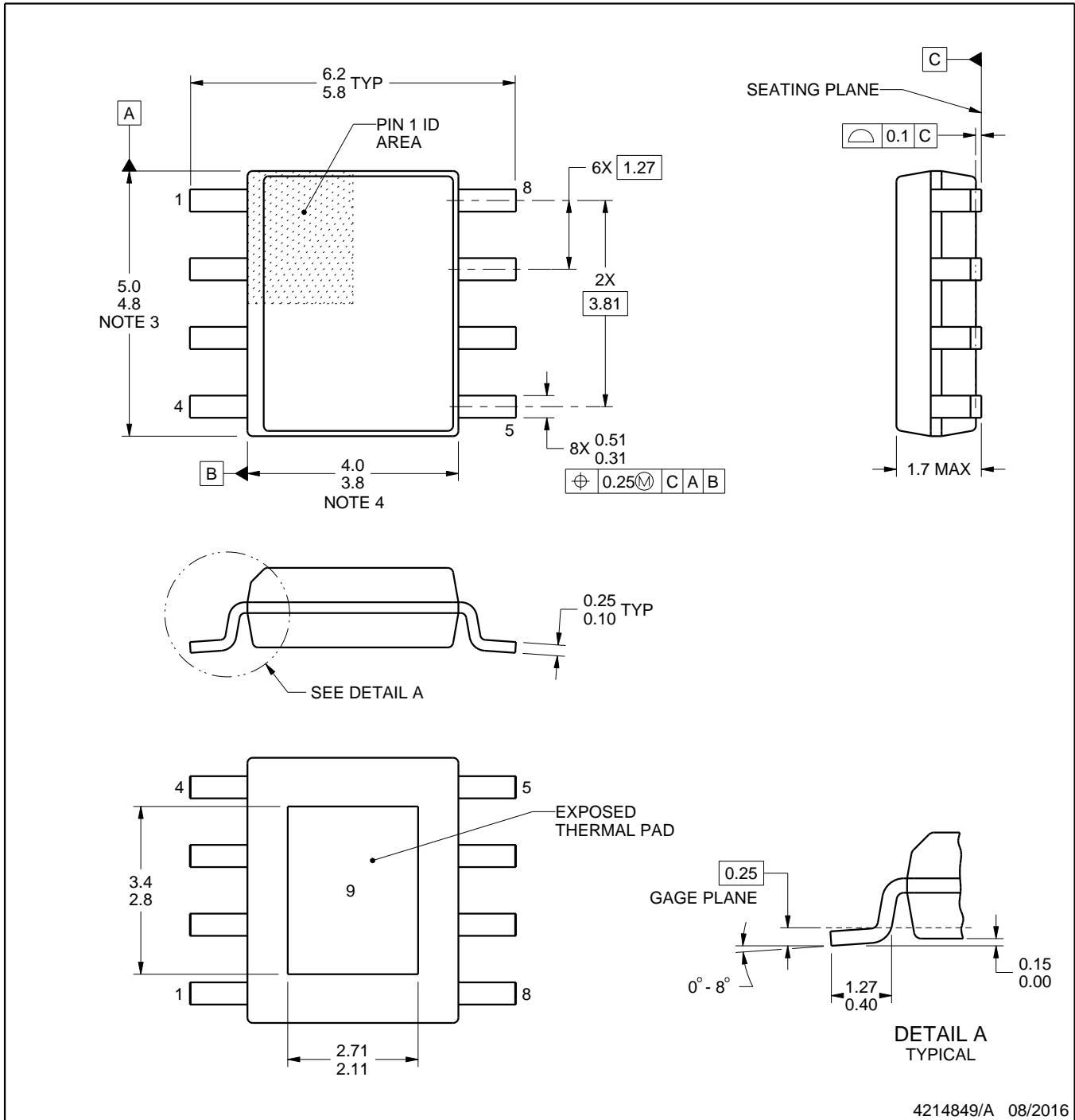

4214849/A 08/2016

PowerPAD is a trademark of Texas Instruments.

NOTES:

1. All linear dimensions are in millimeters. Any dimensions in parenthesis are for reference only. Dimensioning and tolerancing per ASME Y14.5M.
2. This drawing is subject to change without notice.
3. This dimension does not include mold flash, protrusions, or gate burrs. Mold flash, protrusions, or gate burrs shall not exceed 0.15 mm per side.
4. This dimension does not include interlead flash. Interlead flash shall not exceed 0.25 mm per side.
5. Reference JEDEC registration MS-012.

EXAMPLE BOARD LAYOUT

DDA0008B

PowerPAD™ SOIC - 1.7 mm max height

PLASTIC SMALL OUTLINE

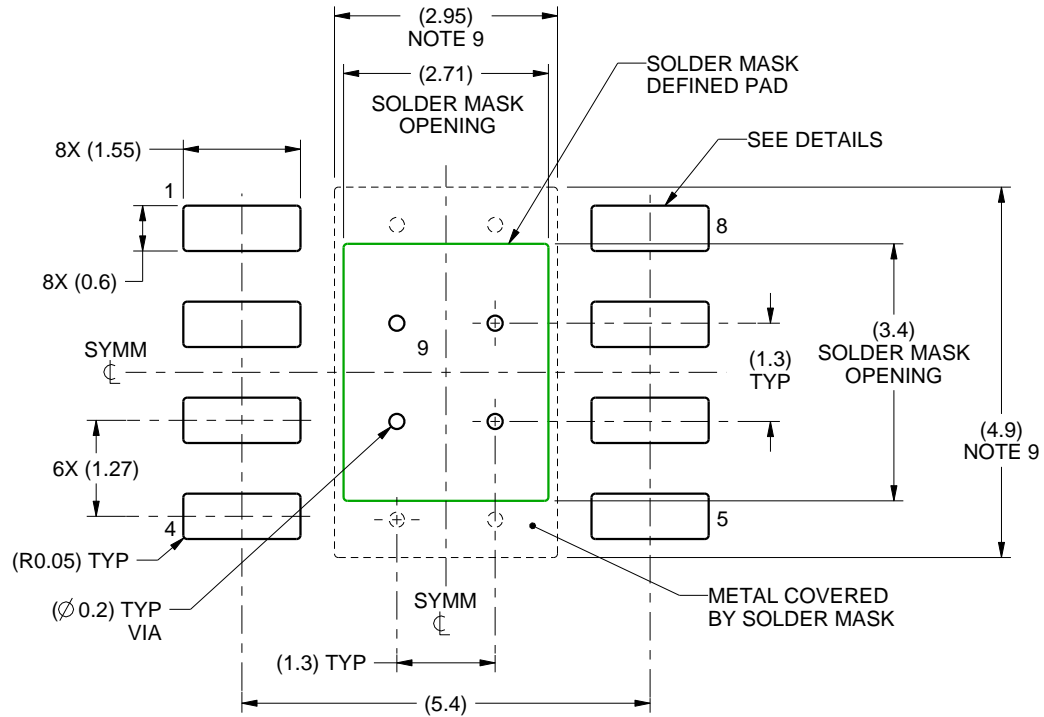

LAND PATTERN EXAMPLE
SCALE:10X

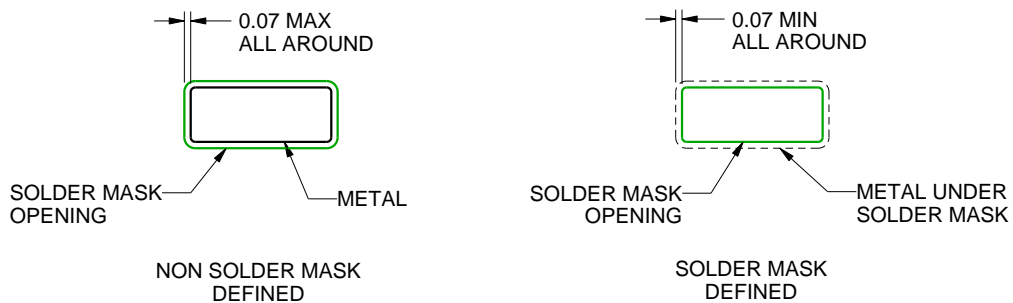

SOLDER MASK DETAILS
PADS 1-8

4214849/A 08/2016

NOTES: (continued)

6. Publication IPC-7351 may have alternate designs.
7. Solder mask tolerances between and around signal pads can vary based on board fabrication site.
8. This package is designed to be soldered to a thermal pad on the board. For more information, see Texas Instruments literature numbers SLMA002 (www.ti.com/lit/slma002) and SLMA004 (www.ti.com/lit/slma004).
9. Size of metal pad may vary due to creepage requirement.
10. Vias are optional depending on application, refer to device data sheet. If any vias are implemented, refer to their locations shown on this view. It is recommended that vias under paste be filled, plugged or tented.

EXAMPLE STENCIL DESIGN

DDA0008B

PowerPAD™ SOIC - 1.7 mm max height

PLASTIC SMALL OUTLINE



SOLDER PASTE EXAMPLE
 EXPOSED PAD
 100% PRINTED SOLDER COVERAGE BY AREA
 SCALE:10X

STENCIL THICKNESS	SOLDER STENCIL OPENING
0.1	3.03 X 3.80
0.125	2.71 X 3.40 (SHOWN)
0.150	2.47 X 3.10
0.175	2.29 X 2.87

4214849/A 08/2016

NOTES: (continued)

11. Laser cutting apertures with trapezoidal walls and rounded corners may offer better paste release. IPC-7525 may have alternate design recommendations.
12. Board assembly site may have different recommendations for stencil design.

IMPORTANT NOTICE

Texas Instruments Incorporated (TI) reserves the right to make corrections, enhancements, improvements and other changes to its semiconductor products and services per JESD46, latest issue, and to discontinue any product or service per JESD48, latest issue. Buyers should obtain the latest relevant information before placing orders and should verify that such information is current and complete.

TI's published terms of sale for semiconductor products (<http://www.ti.com/sc/docs/stdterms.htm>) apply to the sale of packaged integrated circuit products that TI has qualified and released to market. Additional terms may apply to the use or sale of other types of TI products and services.

Reproduction of significant portions of TI information in TI data sheets is permissible only if reproduction is without alteration and is accompanied by all associated warranties, conditions, limitations, and notices. TI is not responsible or liable for such reproduced documentation. Information of third parties may be subject to additional restrictions. Resale of TI products or services with statements different from or beyond the parameters stated by TI for that product or service voids all express and any implied warranties for the associated TI product or service and is an unfair and deceptive business practice. TI is not responsible or liable for any such statements.

Buyers and others who are developing systems that incorporate TI products (collectively, "Designers") understand and agree that Designers remain responsible for using their independent analysis, evaluation and judgment in designing their applications and that Designers have full and exclusive responsibility to assure the safety of Designers' applications and compliance of their applications (and of all TI products used in or for Designers' applications) with all applicable regulations, laws and other applicable requirements. Designer represents that, with respect to their applications, Designer has all the necessary expertise to create and implement safeguards that (1) anticipate dangerous consequences of failures, (2) monitor failures and their consequences, and (3) lessen the likelihood of failures that might cause harm and take appropriate actions. Designer agrees that prior to using or distributing any applications that include TI products, Designer will thoroughly test such applications and the functionality of such TI products as used in such applications.

TI's provision of technical, application or other design advice, quality characterization, reliability data or other services or information, including, but not limited to, reference designs and materials relating to evaluation modules, (collectively, "TI Resources") are intended to assist designers who are developing applications that incorporate TI products; by downloading, accessing or using TI Resources in any way, Designer (individually or, if Designer is acting on behalf of a company, Designer's company) agrees to use any particular TI Resource solely for this purpose and subject to the terms of this Notice.

TI's provision of TI Resources does not expand or otherwise alter TI's applicable published warranties or warranty disclaimers for TI products, and no additional obligations or liabilities arise from TI providing such TI Resources. TI reserves the right to make corrections, enhancements, improvements and other changes to its TI Resources. TI has not conducted any testing other than that specifically described in the published documentation for a particular TI Resource.

Designer is authorized to use, copy and modify any individual TI Resource only in connection with the development of applications that include the TI product(s) identified in such TI Resource. NO OTHER LICENSE, EXPRESS OR IMPLIED, BY ESTOPPEL OR OTHERWISE TO ANY OTHER TI INTELLECTUAL PROPERTY RIGHT, AND NO LICENSE TO ANY TECHNOLOGY OR INTELLECTUAL PROPERTY RIGHT OF TI OR ANY THIRD PARTY IS GRANTED HEREIN, including but not limited to any patent right, copyright, mask work right, or other intellectual property right relating to any combination, machine, or process in which TI products or services are used. Information regarding or referencing third-party products or services does not constitute a license to use such products or services, or a warranty or endorsement thereof. Use of TI Resources may require a license from a third party under the patents or other intellectual property of the third party, or a license from TI under the patents or other intellectual property of TI.

TI RESOURCES ARE PROVIDED "AS IS" AND WITH ALL FAULTS. TI DISCLAIMS ALL OTHER WARRANTIES OR REPRESENTATIONS, EXPRESS OR IMPLIED, REGARDING RESOURCES OR USE THEREOF, INCLUDING BUT NOT LIMITED TO ACCURACY OR COMPLETENESS, TITLE, ANY EPIDEMIC FAILURE WARRANTY AND ANY IMPLIED WARRANTIES OF MERCHANTABILITY, FITNESS FOR A PARTICULAR PURPOSE, AND NON-INFRINGEMENT OF ANY THIRD PARTY INTELLECTUAL PROPERTY RIGHTS. TI SHALL NOT BE LIABLE FOR AND SHALL NOT DEFEND OR INDEMNIFY DESIGNER AGAINST ANY CLAIM, INCLUDING BUT NOT LIMITED TO ANY INFRINGEMENT CLAIM THAT RELATES TO OR IS BASED ON ANY COMBINATION OF PRODUCTS EVEN IF DESCRIBED IN TI RESOURCES OR OTHERWISE. IN NO EVENT SHALL TI BE LIABLE FOR ANY ACTUAL, DIRECT, SPECIAL, COLLATERAL, INDIRECT, PUNITIVE, INCIDENTAL, CONSEQUENTIAL OR EXEMPLARY DAMAGES IN CONNECTION WITH OR ARISING OUT OF TI RESOURCES OR USE THEREOF, AND REGARDLESS OF WHETHER TI HAS BEEN ADVISED OF THE POSSIBILITY OF SUCH DAMAGES.

Unless TI has explicitly designated an individual product as meeting the requirements of a particular industry standard (e.g., ISO/TS 16949 and ISO 26262), TI is not responsible for any failure to meet such industry standard requirements.

Where TI specifically promotes products as facilitating functional safety or as compliant with industry functional safety standards, such products are intended to help enable customers to design and create their own applications that meet applicable functional safety standards and requirements. Using products in an application does not by itself establish any safety features in the application. Designers must ensure compliance with safety-related requirements and standards applicable to their applications. Designer may not use any TI products in life-critical medical equipment unless authorized officers of the parties have executed a special contract specifically governing such use. Life-critical medical equipment is medical equipment where failure of such equipment would cause serious bodily injury or death (e.g., life support, pacemakers, defibrillators, heart pumps, neurostimulators, and implantables). Such equipment includes, without limitation, all medical devices identified by the U.S. Food and Drug Administration as Class III devices and equivalent classifications outside the U.S.

TI may expressly designate certain products as completing a particular qualification (e.g., Q100, Military Grade, or Enhanced Product). Designers agree that it has the necessary expertise to select the product with the appropriate qualification designation for their applications and that proper product selection is at Designers' own risk. Designers are solely responsible for compliance with all legal and regulatory requirements in connection with such selection.

Designer will fully indemnify TI and its representatives against any damages, costs, losses, and/or liabilities arising out of Designer's non-compliance with the terms and provisions of this Notice.

Looking for pricing, stock, or lifecycle information?

Click below to explore more details on WIN SOURCE:

 [View LP3891ES-1.2 on WIN SOURCE](#)

 [Texas Instruments](#) Information

Optimize Your Supply Chain with WIN SOURCE Solutions

-  Global Sourcing Solution
-  Obsolete Management
-  Cost Control Management
-  Shortage Management
-  Alternative Solution
-  Excess Inventory Management