



**THE DATASHEET OF
LP3907SQ-BJX6X/NOPB**



LP3907 Dual 1-A and 600-mA Buck Converters and Dual 300-mA LDOs With I2C Interface

1 Features

- Input Voltage Range: 2.8 V to 5.5 V
- Compatible with Advanced Applications Processors and FPGAs
- 2 LDOs for Powering Internal Processor Functions and I/Os
- High-Speed Serial Interface for Independent Control of Device Functions and Settings
- Precision Internal Reference
- Thermal Overload Protection
- Current Overload Protection
- Software Programmable Regulators
- External Power-On-Reset Function for Buck1 and Buck2 (Power Good with Delay Function)
- Undervoltage Lockout Detector to Monitor Input Supply Voltage
- *Step-Down DC-DC Converters (Buck)*
 - Programmable V_{OUT} from:
 - Buck1 : 0.8 V–2 V at 1 A
 - Buck2 : 1 V–3.5 V at 600 mA
 - Up to 96% Efficiency
 - 2.1-MHz PWM Switching Frequency
 - PWM-to-PFM Automatic Mode Change Under Low Loads
 - $\pm 3\%$ Output Voltage Accuracy
 - Automatic Soft Start
- *Linear Regulators (LDO)*
 - Programmable V_{OUT} of 1 V to 3.5 V (except JJ11, FX6W, and JX6X options)
 - 300-mA Output Current
 - 30-mV (typical) Dropout
 - Create a Custom Design Using the LP3907 With the [WEBENCH® Power Designer](#)

2 Applications

- FPGA, DSP Core Power
- Applications Processors
- Peripheral I/O Power
- Hearing Aids
- Electronic Measurement Units
- Equipment Run-Off of Battery Backup

3 Description

The LP3907 device is a multi-function, programmable power management unit (PMU) optimized for low-power FPGAs, microprocessors, and DSPs. This device integrates two highly efficient 1-A, 600-mA step-down DC-DC converters with dynamic voltage scaling (DVS), two 300-mA linear regulators, and a 400-kHz I²C interface to allow a host controller access to the internal control registers of the device. The LP3907 additionally features programmable power-on sequencing.

Features include programmable power-on sequencing, communication control (I2C), dynamic voltage scaling, overcurrent protection, Power Good, synchronous rectification, thermal shutdown, and undervoltage lockout. For applications requiring light loads, the high-efficiency synchronous switching buck regulators enter PFM mode and operate with reduced switching frequency and supply current to maintain high efficiency at very light loads.

Device Information⁽¹⁾

PART NUMBER	PACKAGE	BODY SIZE (NOM)
LP3907	WQFN (24)	4.00 mm x 4.00 mm
	DSBGA (25)	2.49 mm x 2.49 mm

(1) For all available packages, see the orderable addendum at the end of the data sheet.

Typical Application Circuit

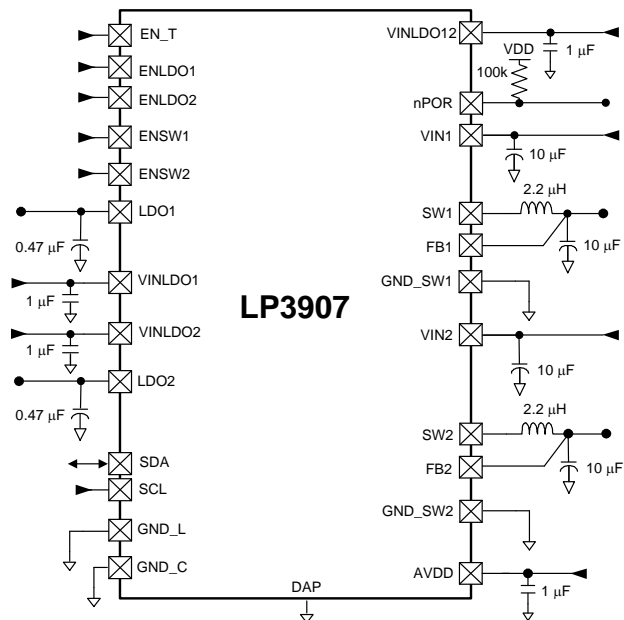

Copyright © 2016, Texas Instruments Incorporated



Table of Contents

1 Features	1	8.2 Functional Block Diagram	18
2 Applications	1	8.3 Feature Description	19
3 Description	1	8.4 Device Functional Modes	27
4 Revision History	2	8.5 Programming	28
5 Device Comparison Tables	3	8.6 Register Maps	31
6 Pin Configuration and Functions	5	9 Application and Implementation	41
7 Specifications	7	9.1 Application Information	41
7.1 Absolute Maximum Ratings	7	9.2 Typical Application	41
7.2 ESD Ratings	7	10 Power Supply Recommendations	47
7.3 Recommended Operating Conditions (Bucks)	7	10.1 Analog Power Signal Routing	47
7.4 Thermal Information	8	11 Layout	48
7.5 General Electrical Characteristics	8	11.1 DSBGA Layout Guidelines	48
7.6 Low Dropout Regulators, LDO1 And LDO2	9	11.2 Layout Example	49
7.7 Buck Converters SW1, SW2	9	11.3 Thermal Considerations of WQFN Package	49
7.8 I/O Electrical Characteristics	10	12 Device and Documentation Support	50
7.9 Power-On Reset (POR) Threshold/Function	10	12.1 Device Support	50
7.10 I ² C Interface Timing Requirements	10	12.2 Documentation Support	50
7.11 Typical Characteristics — LDO	11	12.3 Trademarks	50
7.12 Typical Characteristics — Bucks	13	12.4 Receiving Notification of Documentation Updates	50
7.13 Typical Characteristics — Buck1	14	12.5 Community Resources	50
7.14 Typical Characteristics — Buck2	15	12.6 Electrostatic Discharge Caution	50
7.15 Typical Characteristics — Bucks	16	12.7 Glossary	51
8 Detailed Description	18	13 Mechanical, Packaging, and Orderable Information	51
8.1 Overview	18		

4 Revision History

NOTE: Page numbers for previous revisions may differ from page numbers in the current version.

Changes from Revision T (November 2016) to Revision U	Page
• Added Webench links	1
• Deleted obsolete OPNs from Table 3	4

Changes from Revision S (April 2016) to Revision T	Page
• Changed data sheet title for improved SEO, change dynamic voltage "management" to "scaling", add new paragraph to <i>Description</i>	1

Changes from Revision R (May 2015) to Revision S	Page
• Added additional items to <i>Applications</i>	1
• Changed symbol "θ _n " to "e _N " in <i>Low Dropout Regulators, LDO1 And LDO2 Electrical Char table</i>	9

Changes from Revision Q (January 2015) to Revision R	Page
• Added last sentence to "NOTE"	22

Changes from Revision P (November 2014) to Revision Q	Page
• Changed to new Default Device Options table with updated and additional values	3
• Changed <i>Handling Ratings</i> table to <i>ESD Ratings</i> table; update <i>Thermal Information</i>	7

Changes from Revision O (May 2013) to Revision P
Page

- Added *Device Information and Handling Rating tables, Feature Description, Device Functional Modes, Application and Implementation, Power Supply Recommendations, Layout, Device and Documentation Support, and Mechanical, Packaging, and Orderable Information* sections; moved some curves to *Application Curves* section **1**

5 Device Comparison Tables

Table 1. Default I²C Addresses

PACKAGE TYPE	DEFAULT I ² C ADDRESS
24-lead WQFN	60
25-bump DSBGA	61

Table 2. Power Block

POWER BLOCK INPUT	POWER BLOCK OPERATION		NOTE
	ENABLED	DISABLED	
VINLDO12	VIN+ ⁽¹⁾	VIN+	Always powered
AVDD	VIN+	VIN+	Always powered
VIN1	VIN+	VIN+	
VIN2	VIN+	VIN+	
LDO1	≤ VIN+	≤ VIN+	If enabled, minimum V _{IN} is 1.74 V
LDO2	≤ VIN+	≤ VIN+	If enabled, minimum V _{IN} is 1.74 V

(1) VIN+ is the largest potential voltage on the device.

Table 3. Default Device Options

PART NUMBER ⁽¹⁾⁽²⁾	BUCK1	BUCK2	LDO1	LDO2	BUCK MODES	DEFAULT EN_T DELAY	DEFAULT UVLO
LP3907SQ-TJXIP/NOPB	1.2 V	3.3 V	1.8 V	2.5 V	Forced PWM	001	Enabled
LP3907SQ-JXQX/NOPB	1.2 V	3.3 V	2.6 V	3.3 V	Auto-Mode	010	Enabled
LP3907SQ-PJXIX/NOPB	1.2 V	3.3 V	1.8 V	3.3 V	Forced PWM	010	Enabled
LP3907SQ-PFX6W/NOPB	1 V	3.3 V	2.65 V ⁽³⁾	3.2 V	Forced PWM	010	Enabled
LP3907SQ-BJXQX/NOPB	1.2 V	3.3 V	2.6 V	3.3 V	Forced PWM	010	Disabled
LP3907TL-JJ11/NOPB	1.2 V	1.8 V	2.85 V ⁽³⁾	2.85 V ⁽³⁾	Auto-Mode	010	Enabled
LP3907TLX-JJ11/NOPB	1.2 V	1.8 V	2.85 V ⁽³⁾	2.85 V ⁽³⁾	Auto-Mode	010	Enabled
LP3907TL-JSXS/NOPB	1.2 V	2.8 V	3.3 V	2.8 V	Auto-Mode	010	Enabled
LP3907TL-JJCP/NOPB	1.2 V	1.8 V	1.2 V	2.5 V	Auto-Mode	010	Enabled
LP3907TL-PLNTO/NOPB	1.3 V	2.2 V	2.9 V	2.4 V	Forced PWM	010	Enabled

- (1) For the most current package and ordering information, see the *Package Option Addendum* at the end of this document, or see the TI website at www.ti.com.
- (2) Package drawings, thermal data, and symbolization are available at www.ti.com/packaging.
- (3) Voltage is fixed and not programmable.

6 Pin Configuration and Functions

**RTW Package
24-Pin WQFN
Top View**

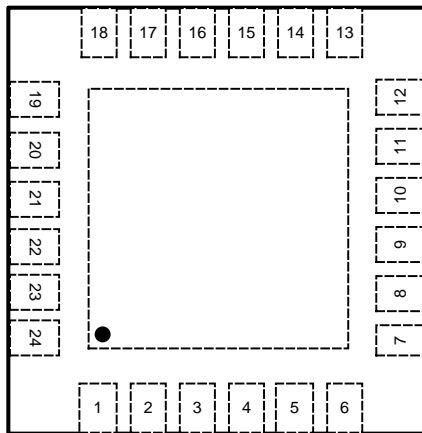

**YZR Package
25-Pin DSBGA
Top View**

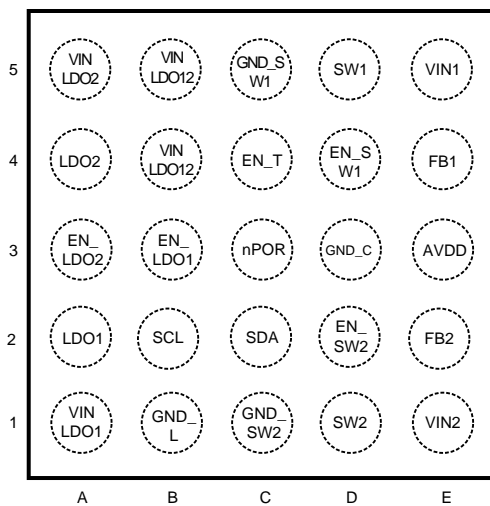

Pin Functions

WQFN NUMBER	PIN		I/O	TYPE ⁽¹⁾	DESCRIPTION
	DSBGA NUMBER	NAME			
1	B4, B5	VINLDO12	I	PWR	Analog power for internal functions (VREF, BIAS, I ² C, Logic)
2	C4	EN_T	I	D	Enable for preset power on sequence. (See .)
3	C3	nPOR	O	D	nPOR power on reset pin for both Buck1 and Buck 2. Open drain logic output 100-kΩ pullup resistor. nPOR is pulled to ground when the voltages on these supplies are not good. See Flexible Power-On Reset (Power Good with Delay) section for more info.
4	C5	GND_SW1	G	G	Buck1 NMOS Power Ground
5	D5	SW1	O	PWR	Buck1 switcher output pin
6	E5	VIN1	I	PWR	Power in from either DC source or battery to Buck1
7	D4	ENSW1	I	D	Enable pin for Buck1 switcher, a logic HIGH enables Buck1
8	E4	FB1	I	A	Buck1 input feedback terminal
9	D3	GND_C	G	G	Non switching core ground pin
10	E3	AVDD	I	PWR	Analog power for Buck converters
11	E2	FB2	I	A	Buck2 input feedback terminal
12	D2	ENSW2	I	D	Enable pin for Buck2 switcher, a logic HIGH enables Buck2
13	E1	VIN2	I	PWR	Power in from either DC source or Battery to Buck2
14	D1	SW2	O	PWR	Buck2 switcher output pin
15	C1	GND_SW2	G	G	Buck2 NMOS power ground
16	C2	SDA	I/O	D	I ² C data (bidirectional)
17	B2	SCL	I	D	I ² C clock
18	B1	GND_L	G	G	LDO ground
19	A1	VINLDO1	I	PWR	Power in from either DC source or battery to input terminal to LDO1
20	A2	LDO1	O	PWR	LDO1 output
21	B3	ENLDO1	I	D	LDO1 enable pin, a logic HIGH enables the LDO1
22	A3	ENLDO2	I	D	LDO2 enable pin, a logic HIGH enables the LDO2
23	A4	LDO2	O	PWR	LDO2 output
24	A5	VINLDO2	I	PWR	Power in from either DC source or battery to input terminal to LDO2.
DAP		DAP	GND	GND	Connection is not necessary for electrical performance, but it is recommended for better thermal dissipation.

(1) **A:** Analog Pin **D:** Digital Pin **G:** Ground Pin **PWR:** Power Pin **I:** Input Pin **I/O:** Input/Output Pin **O:** Output Pin.

7 Specifications

7.1 Absolute Maximum Ratings

over operating free-air temperature range (unless otherwise noted) ⁽¹⁾⁽²⁾

	MIN	MAX	UNIT
V _{IN} , SDA, SCL	-0.3	6	V
GND to GND SLUG		±0.3	V
Power dissipation (WQFN (RTW))(P _{D-MAX}) (T _A = 85°C, T _{MAX} = 125°C) ⁽³⁾		1.43	W
Power dissipation (DSBGA (YZR)) ⁽³⁾ (P _{D-MAX}) (T _A = 85°C, T _{MAX} = 125°C)		0.78	W
Junction temperature, T _{J-MAX}		150	°C
Maximum lead temperature (soldering)		260	°C
Storage temperature, T _{stg}	-65	150	°C

- Stresses beyond those listed under *Absolute Maximum Ratings* may cause permanent damage to the device. These are stress ratings only, which do not imply functional operation of the device at these or any other conditions beyond those indicated under *Recommended Operating Conditions (Bucks)*. Exposure to absolute-maximum-rated conditions for extended periods may affect device reliability.
- All voltages are with respect to the potential at the GND pin.
- In applications where high power dissipation and/or poor package thermal resistance is present, the maximum ambient temperature may have to be derated. Maximum ambient temperature (T_{A-MAX}) is dependent on the maximum operating junction temperature (T_{J-MAX-OP} = 125°C), the maximum power dissipation of the device in the application (P_{D-MAX}), and the junction-to-ambient thermal resistance of the part/package in the application (R_{θJA}), as given by the following equation: T_{A-MAX} = T_{J-MAX-OP} - (R_{θJA} × P_{D-MAX}).

7.2 ESD Ratings

		VALUE	UNIT
V _(ESD) Electrostatic discharge	Human-body model (HBM), per ANSI/ESDA/JEDEC JS-001 ⁽¹⁾	±2000	V
	Charged-device model (CDM), per JEDEC specification JESD22-C101 ⁽²⁾	±750	

- JEDEC document JEP155 states that 500-V HBM allows safe manufacturing with a standard ESD control process.
- JEDEC document JEP157 states that 250-V CDM allows safe manufacturing with a standard ESD control process.

7.3 Recommended Operating Conditions (Bucks)

over operating free-air temperature range (unless otherwise noted) ⁽¹⁾⁽²⁾⁽³⁾⁽⁴⁾

	MIN	MAX	UNIT
V _{IN}	2.8	5.5	V
V _{EN}	0	(V _{IN} + 0.3 V)	V
Junction temperature, T _J	-40	125	°C
Ambient temperature, T _A ⁽⁵⁾	-40	85	°C

- Stresses beyond those listed under *Absolute Maximum Ratings* may cause permanent damage to the device. These are stress ratings only, which do not imply functional operation of the device at these or any other conditions beyond those indicated under *Recommended Operating Conditions*. Exposure to absolute-maximum-rated conditions for extended periods may affect device reliability.
- All voltages are with respect to the potential at the GND pin.
- Minimum (Minimum) and Maximum (Maximum) limits are ensured by design, test, or statistical analysis. Typical numbers are not ensured, but do represent the most likely norm.
- Buck V_{IN} ≥ V_{OUT} + 1 V.
- Junction-to-ambient thermal resistance is highly application and board-layout dependent. In applications where high maximum power dissipation exists, special care must be paid to thermal dissipation issues in board design.

7.4 Thermal Information

See ⁽¹⁾⁽²⁾⁽³⁾

THERMAL METRIC ⁽⁴⁾		LP3907		UNIT
		RTW	YZR	
		24 PINS	25 PINS	
R _{θJA}	Junction-to-ambient thermal resistance	32.7	58.7	°C/W
R _{θJC(top)}	Junction-to-case (top) thermal resistance	31.2	0.3	°C/W
R _{θJB}	Junction-to-board thermal resistance	11.2	8.0	°C/W
ψ _{JT}	Junction-to-top characterization parameter	0.2	0.6	°C/W
ψ _{JB}	Junction-to-board characterization parameter	11.2	8.0	°C/W
R _{θJC(bot)}	Junction-to-case (bottom) thermal resistance	1.4	N/A	°C/W

- (1) Junction-to-ambient thermal resistance is highly application and board-layout dependent. In applications where high maximum power dissipation exists, special care must be paid to thermal dissipation issues in board design.
- (2) Internal thermal shutdown circuitry protects the device from permanent damage. Thermal shutdown engages at T_J = 160°C (typical) and disengages at T_J = 140°C (typical).
- (3) In applications where high power dissipation and/or poor package thermal resistance is present, the maximum ambient temperature may have to be derated. Maximum ambient temperature (T_{A-MAX}) is dependent on the maximum operating junction temperature (T_{J-MAX-OP} = 125°C), the maximum power dissipation of the device in the application (P_{D-MAX}), and the junction-to-ambient thermal resistance of the part/package in the application (R_{θJA}), as given by the following equation: T_{A-MAX} = T_{J-MAX-OP} - (R_{θJA} × P_{D-MAX}).
- (4) For more information about traditional and new thermal metrics, see the [Semiconductor and IC Package Thermal Metrics](#) application report.

7.5 General Electrical Characteristics

Unless otherwise noted, V_{IN} = 3.6 V and T_J = 25°C. ⁽¹⁾⁽²⁾⁽³⁾⁽⁴⁾

PARAMETER		TEST CONDITIONS	MIN	TYP	MAX	UNIT
I _Q	VINLDO12 shutdown current	V _{IN} = 3.6 V		3		μA
V _{POR}	Power-on reset threshold	V _{DD} falling edge ⁽⁴⁾		1.9		V
T _{SD}	Thermal shutdown threshold			160		°C
T _{SDH}	Thermal shutdown hysteresis			20		°C
UVLO	Undervoltage lockout	Rising		2.9		V
		Falling		2.7		

- (1) Stresses beyond those listed under *Absolute Maximum Ratings* may cause permanent damage to the device. These are stress ratings only, which do not imply functional operation of the device at these or any other conditions beyond those indicated under *Recommended Operating Conditions*. Exposure to absolute-maximum-rated conditions for extended periods may affect device reliability.
- (2) All voltages are with respect to the potential at the GND pin.
- (3) This specification is ensured by design.
- (4) VPOR is voltage at which the EPROM resets. This is different from the UVLO on VINLDO12, which is the voltage at which the regulators shut off, and is also different from the nPOR function, which signals if the regulators are in a specified range.

7.6 Low Dropout Regulators, LDO1 And LDO2

Unless otherwise noted, $V_{IN} = 3.6\text{ V}$, $C_{IN} = 1\ \mu\text{F}$, $C_{OUT} = 0.47\ \mu\text{F}$, and $T_J = 25^\circ\text{C}$.⁽¹⁾⁽²⁾⁽³⁾⁽⁴⁾⁽⁵⁾⁽⁶⁾⁽⁷⁾

PARAMETER		TEST CONDITIONS	MIN	TYP	MAX	UNIT
V_{IN}	Operational voltage range	VINLDO1 and VINLDO2 PMOS pins ⁽⁸⁾	1.74 ⁽⁹⁾		5.5 ⁽⁹⁾	V
V_{OUT} Accuracy	Output voltage accuracy (default V_{OUT})	Load current = 1 mA	-3% ⁽⁹⁾		3% ⁽⁹⁾	
ΔV_{OUT}	Line regulation	$V_{IN} = (V_{OUT} + 0.3\text{ V})$ to 5 V, ⁽⁷⁾ load current = 1 mA			0.15 ⁽⁹⁾	%/V
	Load regulation	$V_{IN} = 3.6\text{ V}$, Load current = 1 mA to I_{MAX}			0.011 ⁽⁹⁾	%/mA
I_{SC}	Short circuit current limit	LDO1-2, $V_{OUT} = 0\text{ V}$		500		mA
$V_{IN} - V_{OUT}$	Dropout voltage	Load current = 50 mA ⁽⁵⁾		30	200 ⁽⁹⁾	mV
PSRR	Power supply ripple rejection	$f = 10\text{ kHz}$, load current = I_{MAX}		45		dB
ϵ_N	Supply output noise	10 Hz < F < 100 KHz		80		μVrms
I_Q ⁽⁶⁾⁽¹⁰⁾	Quiescent current on	$I_{OUT} = 0\text{ mA}$		40		μA
	Quiescent current on	$I_{OUT} = I_{MAX}$		60		μA
	Quiescent current off	EN is de-asserted ⁽¹¹⁾		0.03		μA
T_{ON}	Turnon time	Start-up from shutdown		300		μs
C_{OUT}	Output capacitor	Capacitance for stability $0^\circ\text{C} \leq T_J \leq 125^\circ\text{C}$	0.33 ⁽⁹⁾	0.47		μF
		$-40^\circ\text{C} \leq T_J \leq 125^\circ\text{C}$	0.68	1		μF
		ESR	5 ⁽⁹⁾		500 ⁽⁹⁾	m Ω

- (1) All voltages are with respect to the potential at the GND pin.
- (2) Minimum (MIN) and maximum (MAX) limits are ensured by design, test, or statistical analysis. Typical numbers are not ensured, but do represent the most likely norm.
- (3) C_{IN} , C_{OUT} : Low-ESR Surface-Mount Ceramic Capacitors (MLCCs) used in setting electrical characteristics.
- (4) The device maintains a stable, regulated output voltage without a load.
- (5) Dropout voltage is the voltage difference between the input and the output at which the output voltage drops to 100 mV below its nominal value.
- (6) Quiescent current is defined here as the difference in current between the input voltage source and the load at V_{OUT} .
- (7) V_{IN} minimum for line regulation values is 1.8 V.
- (8) Pins 24, 19 can operate from V_{IN} min of 1.74 V to a V_{IN} max of 5.5 V. This rating is only for the series pass PMOS power FET. It allows the system design to use a lower voltage rating if the input voltage comes from a buck output.
- (9) Limits apply over the entire junction temperature range for operation, -40°C to $+125^\circ\text{C}$.
- (10) The I_Q can be defined as the standing current of the LP3907 when the I²C bus is active and all other power blocks have been disabled with the I²C bus, or it can be defined as the I²C bus active, and the other power blocks are active under no load condition. These two values can be used by the system designer when the LP3907 is powered using a battery.
- (11) The I_Q exhibits a higher current draw when the EN pin is de-asserted because the I²C buffer pins draw an additional 2 μA .

7.7 Buck Converters SW1, SW2

Unless otherwise noted, $V_{IN} = 3.6\text{ V}$, $C_{IN} = 10\ \mu\text{F}$, $C_{OUT} = 10\ \mu\text{F}$, $L_{OUT} = 2.2\text{-}\mu\text{H}$ ceramic, and $T_J = 25^\circ\text{C}$.⁽¹⁾⁽²⁾⁽³⁾⁽⁴⁾⁽⁵⁾⁽⁶⁾

PARAMETER		TEST CONDITIONS	MIN	TYP	MAX	UNIT
V_{FB}	Feedback voltage		-3% ⁽⁷⁾		3% ⁽⁷⁾	
V_{OUT}	Line regulation	$2.8\text{ V} < V_{IN} < 5.5\text{ V}$ $I_{OUT} = 10\text{ mA}$		0.089		%/V
	Load regulation	$100\text{ mA} < I_{OUT} < I_{MAX}$		0.0013		%/mA
Eff	Efficiency	Load current = 250 mA		96%		
I_{SHDN}	Shutdown supply current	EN is de-asserted		0.01		μA
f_{OSC}	Internal oscillator frequency		1.7 ⁽⁷⁾	2.1		MHz

- (1) All voltages are with respect to the potential at the GND pin.
- (2) Minimum (Min) and Maximum (Max) limits are ensured by design, test, or statistical analysis. Typical numbers are not ensured, but do represent the most likely norm.
- (3) C_{IN} , C_{OUT} : Low-ESR Surface-Mount Ceramic Capacitors (MLCCs) used in setting electrical characteristics.
- (4) The device maintains a stable, regulated output voltage without a load.
- (5) Quiescent current is defined here as the difference in current between the input voltage source and the load at V_{OUT} .
- (6) Buck $V_{IN} \geq V_{OUT} + 1\text{ V}$.
- (7) Limits apply over the entire junction temperature range for operation, -40°C to $+125^\circ\text{C}$.

Buck Converters SW1, SW2 (continued)

Unless otherwise noted, $V_{IN} = 3.6\text{ V}$, $C_{IN} = 10\text{ }\mu\text{F}$, $C_{OUT} = 10\text{ }\mu\text{F}$, $L_{OUT} = 2.2\text{-}\mu\text{H}$ ceramic, and $T_J = 25^\circ\text{C}$.⁽¹⁾⁽²⁾⁽³⁾⁽⁴⁾⁽⁵⁾⁽⁶⁾

PARAMETER		TEST CONDITIONS	MIN	TYP	MAX	UNIT
I _{PEAK}	Buck1 peak switching current limit			1.5		A
	Buck2 peak switching current limit			1		
I _Q ⁽⁸⁾	Quiescent current "on"	No load PFM mode		33		μA
R _{DS(on)} (P)	Pin-pin resistance PFET			200		m Ω
R _{DS(on)} (N)	Pin-pin resistance NFET			180		m Ω
T _{ON}	Turnon time	Start up from shutdown		500		μs
C _{IN}	Input capacitor	Capacitance for stability	10			μF
C _{OUT}	Output capacitor	Capacitance for stability	10			μF

(8) The I_Q can be defined as the standing current of the LP3907 when the I²C bus is active and all other power blocks have been disabled with the I²C bus, or it can be defined as the I²C bus active, and the other power blocks are active under no load condition. These two values can be used by the system designer when the device is powered using a battery.

7.8 I/O Electrical Characteristics

Unless otherwise noted: Limits apply over the entire junction temperature range for operation, $T_J = -40^\circ\text{C}$ to $+125^\circ\text{C}$.⁽¹⁾

PARAMETER		TEST CONDITIONS	MIN	MAX	UNIT
V _{IL}	Input low level			0.4	V
V _{IH}	Input high level		1.2		

(1) This specification is ensured by design.

7.9 Power-On Reset (POR) Threshold/Function

PARAMETER		TEST CONDITIONS	MIN	TYP	MAX	UNIT
nPOR	nPOR = Power on reset for Buck1 and Buck2	Default		50		ms
nPOR threshold	Percentage of target voltage Buck1 or Buck2	V _{BUCK1} AND V _{BUCK2} rising		94%		
		V _{BUCK1} OR V _{BUCK2} falling		85%		
VOL	Output level low	Load = IoL = 500 mA	0.23		0.5	V

7.10 I²C Interface Timing Requirements

Unless otherwise noted, $V_{IN} = 3.6\text{ V}$ and $T_J = 25^\circ\text{C}$.⁽¹⁾

		MIN	NOM	MAX	UNIT
f _{CLK}	Clock frequency			400	kHz
t _{BF}	Bus-free time between start and stop	1.3			μs
t _{HOLD}	Hold time repeated start condition	0.6			μs
t _{CLKLP}	CLK low period	1.3			μs
t _{CLKHP}	CLK high period	0.6			μs
t _{SU}	Set-up time repeated start condition	0.6			μs
t _{DATAHLD}	Data hold time	0			μs
t _{DATASU}	Data set-up time	100			ns
T _{SU}	Set-up time for start condition	0.6			μs
T _{TRANS}	Maximum pulse width of spikes that must be suppressed by the input filter of both DATA & CLK signals		50		ns

(1) This specification is ensured by design.

7.11 Typical Characteristics — LDO

$T_A = 25^\circ\text{C}$ unless otherwise noted.

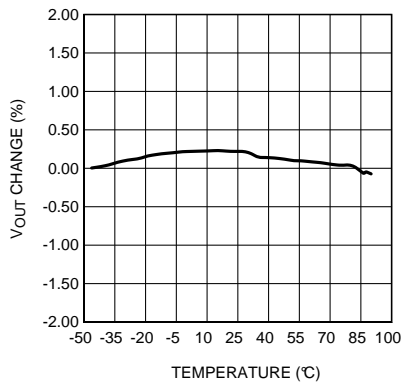

$V_{IN} = 3.6\text{ V}$ $V_{OUT} = 2.6\text{ V}$ 100-mA Load

Figure 1. Output Voltage Change vs Temperature (LDO1)

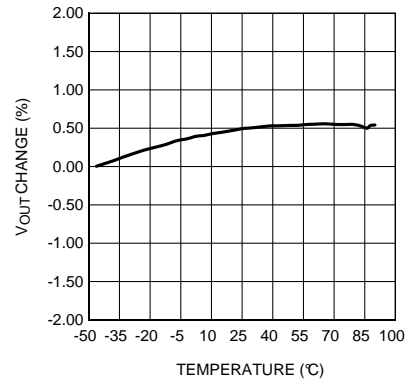

$V_{IN} = 3.6\text{ V}$ $V_{OUT} = 2.6\text{ V}$ 100-mA Load

Figure 2. Output Voltage Change vs Temperature (LDO2)

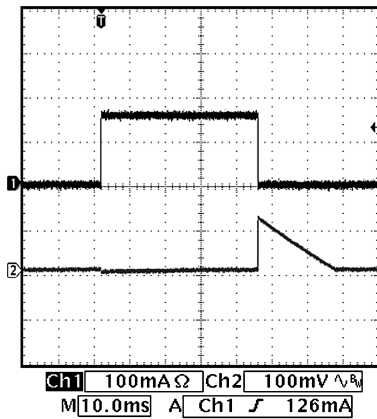

$V_{IN} = 3.6\text{ V}$ $V_{OUT} = 2.6\text{ V}$ 0 to 150-mA Load

Figure 3. Load Transient (LDO1)

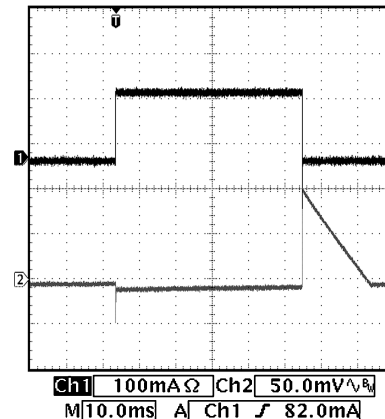

$V_{IN} = 3.6\text{ V}$ $V_{OUT} = 3.3\text{ V}$ 0 to 150-mA Load

Figure 4. Load Transient (LDO2)

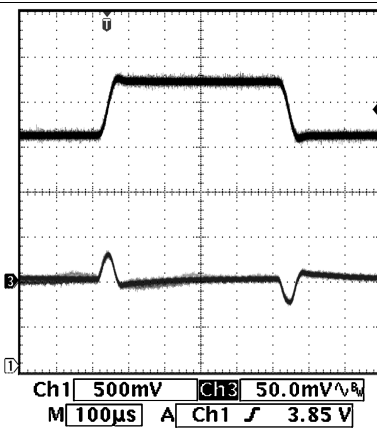

$V_{IN} = 3.6\text{ to }4.2\text{ V}$ $V_{OUT} = 2.6\text{ V}$ 300-mA Load

Figure 5. Line Transient (LDO1)

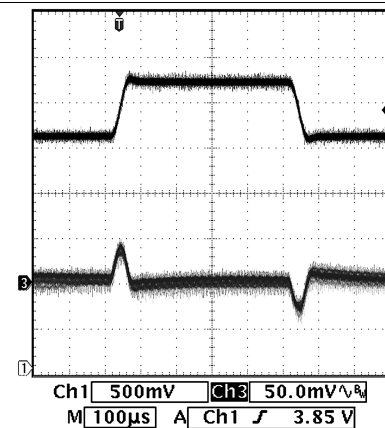

$V_{IN} = 3.6\text{ to }4.2\text{ V}$ $V_{OUT} = 3.3\text{ V}$ 300-mA Load

Figure 6. Line Transient (LDO2)

Typical Characteristics — LDO (continued)

T_A = 25°C unless otherwise noted.

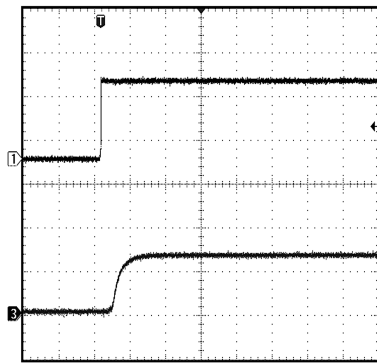

Ch1 2.00 V Ch2 2.00 V
M 100µs A Ch1 1.48 V
V_{IN} = 0 to 3.6 V V_{OUT} = 2.6 V 1-mA Load

Figure 7. Enable Start-Up Time (LDO1)

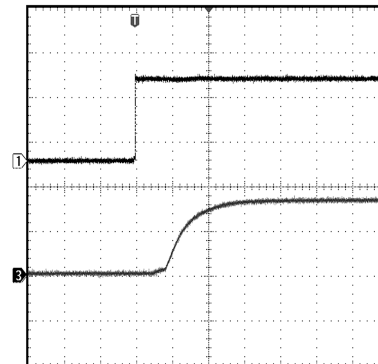

Ch1 2.00 V Ch2 2.00 V
M 40.0µs A Ch1 1.36 V
V_{IN} = 0 to 3.6 V V_{OUT} = 3.3 V 1-mA Load

Figure 8. Enable Start-Up Time (LDO2)

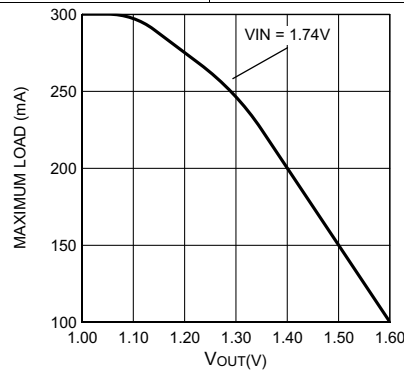

V_{IN} = 1.74 V

Figure 9. LDO Maximum Load

7.12 Typical Characteristics — Bucks

$V_{IN} = 2.8\text{ V to }5.5\text{ V}$, $T_A = 25^\circ\text{C}$

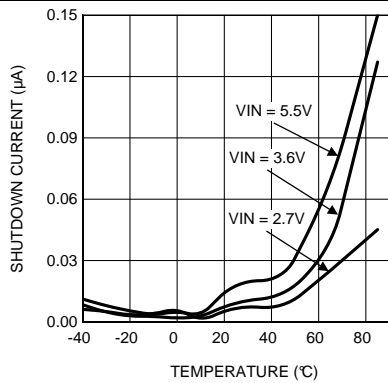
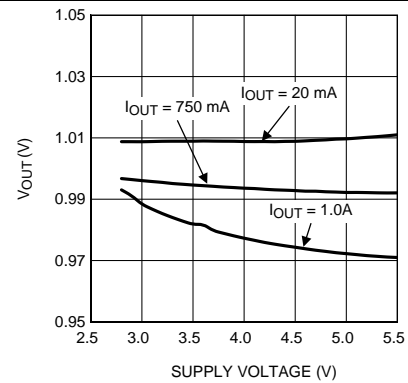
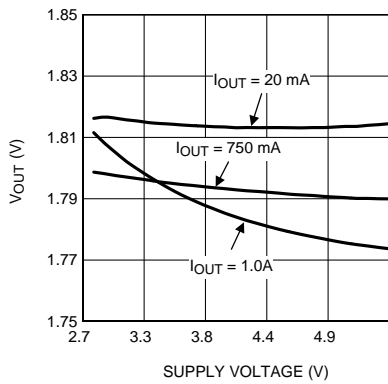

Figure 10. Shutdown Current vs. Temp



$V_{OUT} = 1\text{ V}$

Figure 11. Output Voltage vs. Supply Voltage



$V_{OUT} = 1.8\text{ V}$

Figure 12. Output Voltage vs. Supply Voltage

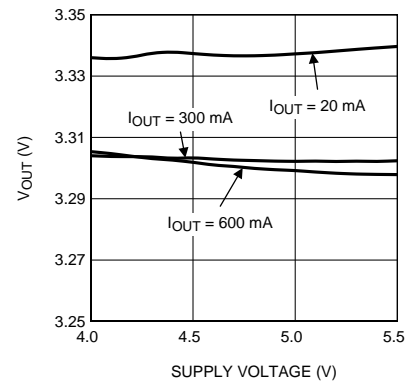

$V_{OUT} = 3.5\text{ V}$

Figure 13. Output Voltage vs. Supply Voltage

7.13 Typical Characteristics — Buck1

$V_{IN} = 2.8\text{ V to } 5.5\text{ V}$, $T_A = 25^\circ\text{C}$, $V_{OUT} = 1.2\text{ V, } 2\text{ V}$

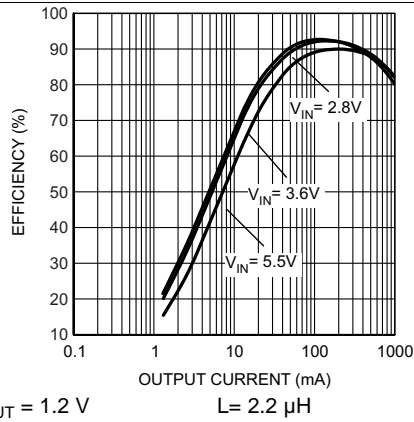

Figure 14. Efficiency vs Output Current (Forced PWM Mode)

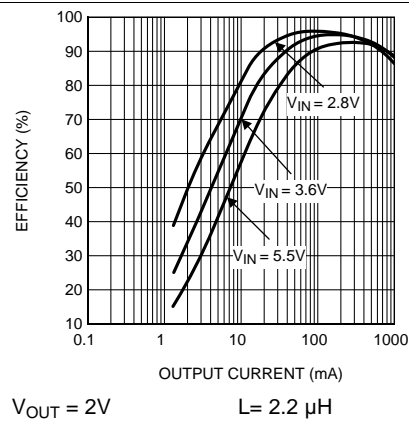

Figure 15. Efficiency vs Output Current (Forced PWM Mode)

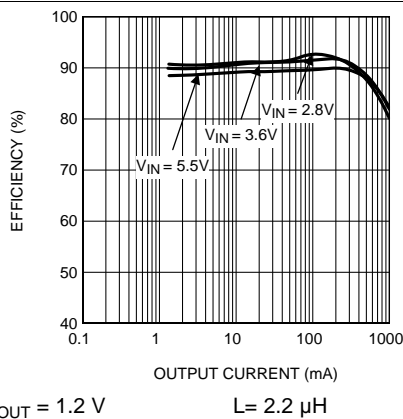

Figure 16. Efficiency vs Output Current (PWM-to-PFM Mode)

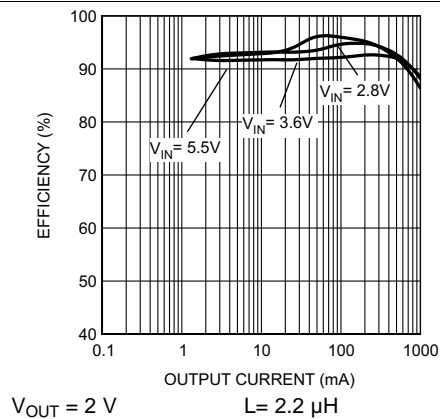

Figure 17. Efficiency vs Output Current (PWM-to-PFM Mode)

7.14 Typical Characteristics — Buck2

V_{IN} = 4.5 V to 5.5 V, T_A = 25°C, V_{OUT} = 1.8 V, 3.3 V

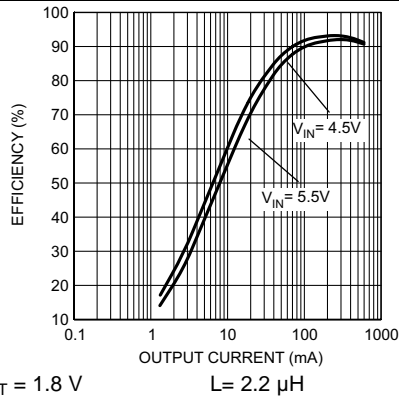

Figure 18. Efficiency vs Output Current (Forced PWM Mode)

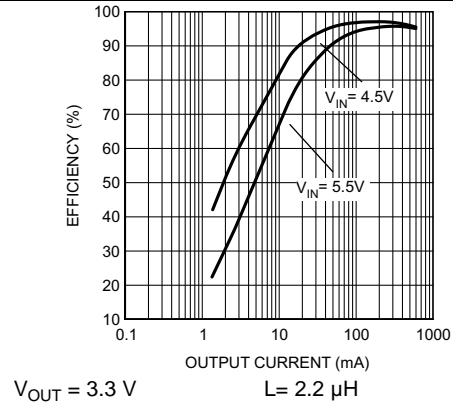

Figure 19. Efficiency vs Output Current (Forced PWM Mode)

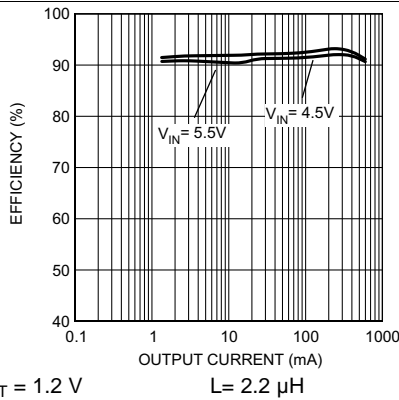

Figure 20. Efficiency vs Output Current (PWM-to-PFM Mode)

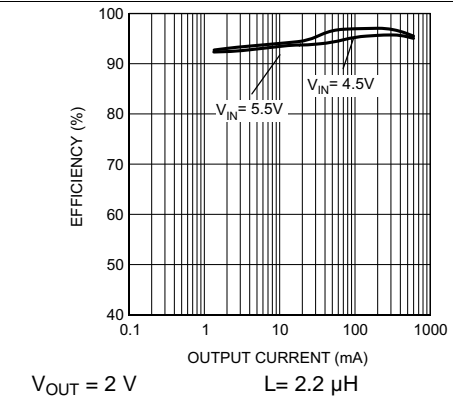
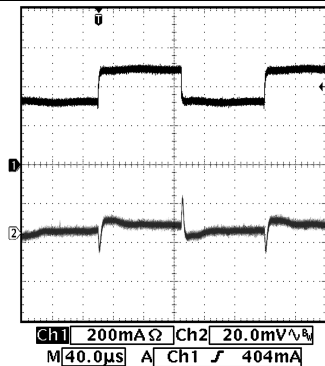

Figure 21. Efficiency vs Output Current (PWM-to-PFM Mode)

7.15 Typical Characteristics — Bucks

$V_{IN} = 3.6\text{ V}$, $T_A = 25^\circ\text{C}$, $V_{OUT} = 1.2\text{ V}$ unless otherwise noted.



$V_{OUT} = 1.2\text{ V}$ $I_{LOAD} = 300\text{ to }500\text{ mA}$

Figure 22. Load Transient Response (PWM Mode)

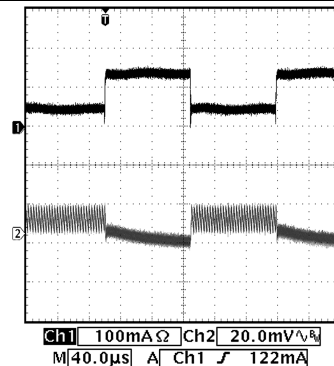

$V_{OUT} = 1.2\text{ V}$ $I_{LOAD} = 50\text{ to }150\text{ mA}$

Figure 23. Mode Change By Load Transient (PFM-to-PWM Mode)

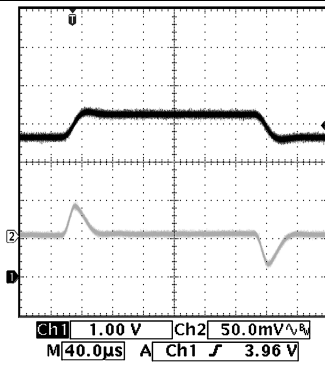

$V_{IN} = 3.6\text{ to }4.2\text{ V}$ $V_{OUT} = 1.2\text{ V}$ 250-mA Load

Figure 24. Line Transient Response

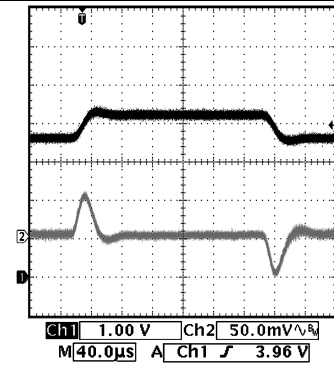

$V_{IN} = 3.6\text{ to }4.2\text{ V}$ $V_{OUT} = 3.3\text{ V}$ 250-mA Load

Figure 25. Line Transient Response

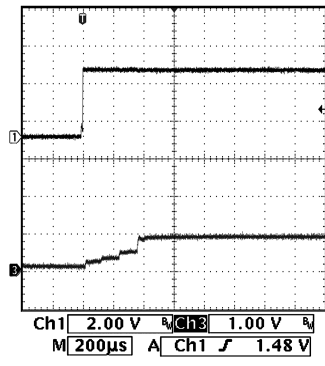

$V_{OUT} = 1.2\text{ V}$ 1-A Load

Figure 26. Start-Up Into PWM Mode

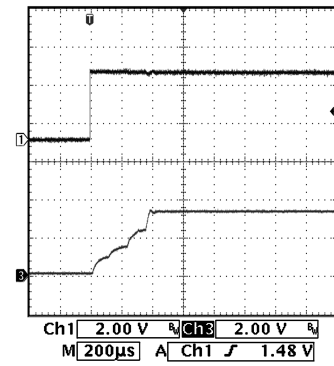

$V_{OUT} = 3.3\text{ V}$ 600-mA Load

Figure 27. Start-Up Into PWM Mode

Typical Characteristics — Bucks (continued)

$V_{IN} = 3.6\text{ V}$, $T_A = 25^\circ\text{C}$, $V_{OUT} = 1.2\text{ V}$ unless otherwise noted.

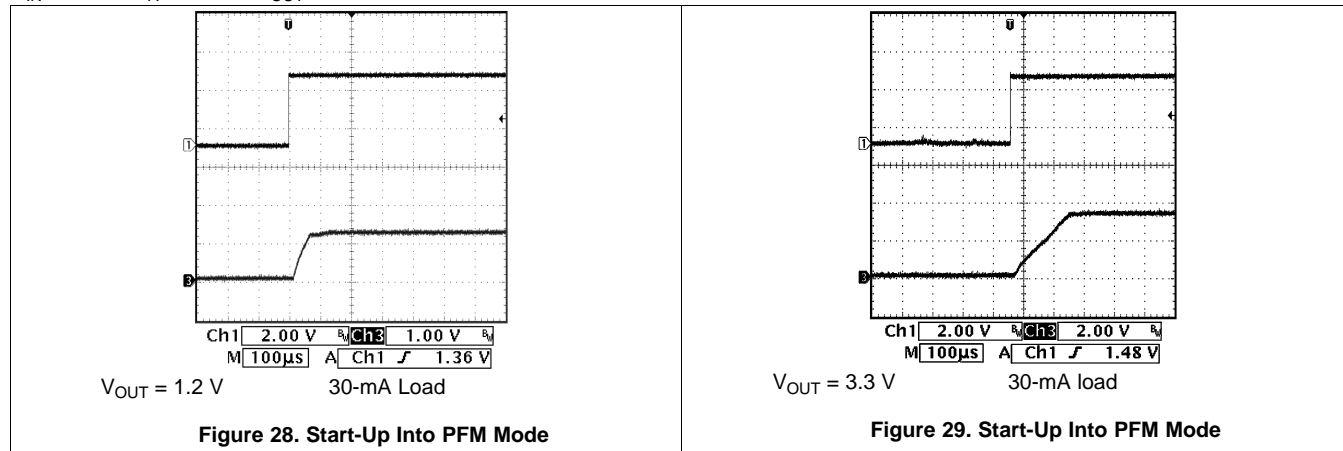

8 Detailed Description

8.1 Overview

The LP3907 supplies the various power needs of the application by means of two linear low drop regulators (LDO1 and LDO2) and two buck converters (SW1 and SW2). [Table 4](#) lists the output characteristics of the various regulators.

Table 4. Supply Specification

SUPPLY ⁽¹⁾	LOAD	OUTPUT		
		V _{OUT} RANGE (V)	RESOLUTION (mV)	I _{MAX} MAXIMUM OUTPUT CURRENT (mA)
LDO1	analog	1 to 3.5	100	300
LDO2	analog	1 to 3.5	100	300
SW1	digital	0.8 to 2	50	1000
SW2	digital	1 to 3.5	100	600

(1) For default values of the regulators, consult [Table 3](#).

8.2 Functional Block Diagram

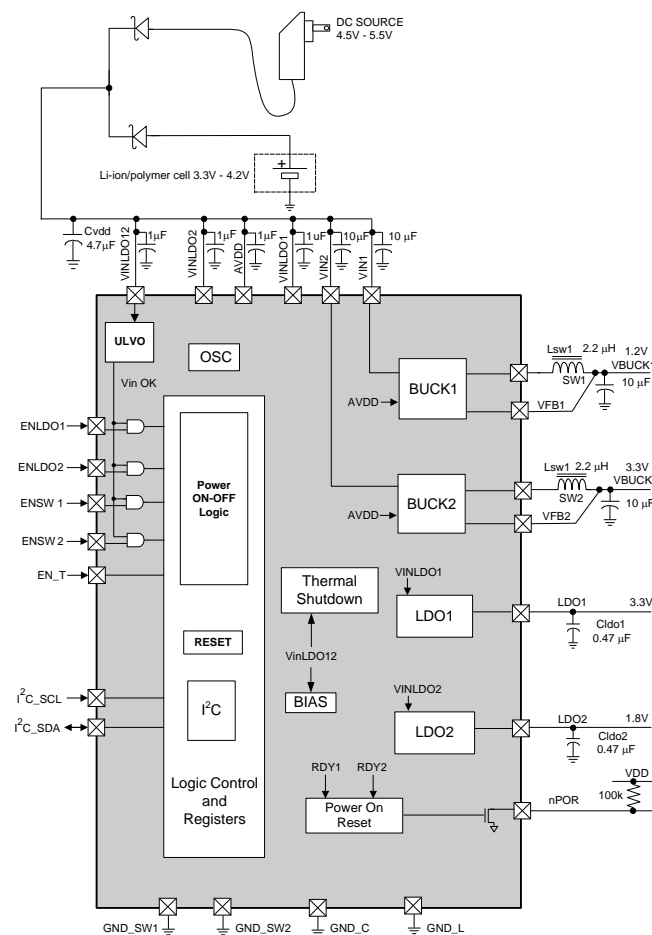

Copyright © 2016, Texas Instruments Incorporated

8.3 Feature Description

8.3.1 DC-DC Converters

8.3.1.1 Linear Low Dropout Regulators (LDOs)

LDO1 and LDO2 are identical linear regulators targeting analog loads characterized by low noise requirements. LDO1 and LDO2 are enabled through the ENLDO pin or through the corresponding LDO1 or LDO2 control register. The output voltages of both LDOs are register programmable. The default output voltages are factory programmed during final test, which can be tailored to the specific needs of the system designer.

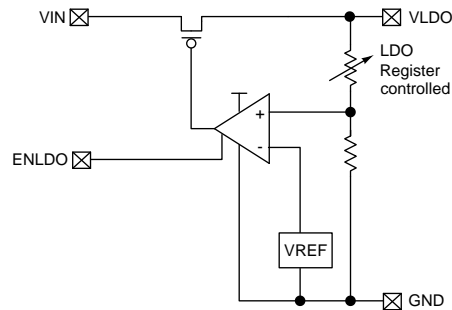

Copyright © 2016, Texas Instruments Incorporated

Figure 30. LDO Block Diagram

8.3.1.2 No-Load Stability

The LDOs remain stable and in regulation with no external load. This is an important consideration in some circuits, for example, CMOS RAM keep-alive applications.

8.3.1.3 LDO and LDO2 Control Registers

LDO1 and LDO2 can be configured by means of the LDO1 and LDO2 control registers. The output voltage is programmable in steps of 100 mV from 1 V to 3.5 V by programming bits D4-D0 in the LDO Control registers. Both LDO1 and LDO2 are enabled by applying a logic 1 to the ENLDO1 and ENLDO2 pin. Enable/disable control is also provided through enable bit of the LDO1 and LDO2 control registers. The value of the enable LDO bit in the register is logic 1 by default. The output voltage can be altered while the LDO is enabled.

8.3.2 SW1, SW2: Synchronous Step-Down Magnetic DC-DC Converters

8.3.2.1 Functional Description

The LP3907 incorporates two high-efficiency synchronous switching buck regulators, SW1 and SW2, that deliver a constant voltage from a single Li-Ion battery to the portable system processors. Using a voltage mode architecture with synchronous rectification, both bucks have the ability to deliver up to 1000 mA and 600 mA, respectively, depending on the input voltage and output voltage (voltage headroom), and the inductor chosen (maximum current capability).

There are three modes of operation depending on the current required: PWM, PFM, and shutdown. PWM mode handles current loads of approximately 70 mA or higher, delivering voltage precision of $\pm 3\%$ with 90% efficiency or better. Lighter output current loads cause the device to automatically switch into PFM for reduced current consumption ($I_Q = 15 \mu\text{A}$ typical) and a longer battery life. The standby operating mode turns off the device, offering the lowest current consumption. PWM or PFM mode is selected automatically or PWM mode can be forced through the setting of the buck control register.

Both SW1 and SW2 can operate up to a 100% duty cycle (PMOS switch always on) for low drop out control of the output voltage. In this way the output voltage is controlled down to the lowest possible input voltage.

Additional features include soft-start, undervoltage lockout, current overload protection, and thermal overload protection.

Feature Description (continued)

8.3.2.2 Circuit Operation Description

A buck converter contains a control block, a switching PFET connected between input and output, a synchronous rectifying NFET connected between the output and ground (BCKGND pin) and a feedback path. During the first portion of each switching cycle, the control block turns on the internal PFET switch. This allows current to flow from the input through the inductor to the output filter capacitor and load. The inductor limits the current to a ramp with a slope of

$$\frac{V_{IN} - V_{OUT}}{L} \quad (1)$$

by storing energy in a magnetic field. During the second portion of each cycle, the control block turns the PFET switch off, blocking current flow from the input, and then turns the NFET synchronous rectifier on. The inductor draws current from ground through the NFET to the output filter capacitor and load, which ramps the inductor current down with a slope of

$$\frac{-V_{OUT}}{L} \quad (2)$$

The output filter stores charge when the inductor current is high, and releases it when low, smoothing the voltage across the load.

8.3.2.3 PWM Operation

During PWM operation the converter operates as a voltage-mode controller with input voltage feed forward. This allows the converter to achieve excellent load and line regulation. The DC gain of the power stage is proportional to the input voltage. To eliminate this dependence, feed forward voltage inversely proportional to the input voltage is introduced.

8.3.2.4 Internal Synchronous Rectification

While in PWM mode, the buck uses an internal NFET as a synchronous rectifier to reduce rectifier forward voltage drop and associated power loss. Synchronous rectification provides a significant improvement in efficiency whenever the output voltage is relatively low compared to the voltage drop across an ordinary rectifier diode.

8.3.2.5 Current Limiting

A current limit feature allows the converter to protect itself and external components during overload conditions. PWM mode implements current limiting using an internal comparator that trips at 1.5 A for Buck1 and at 1 A for Buck2 (typical). If the output is shorted to ground the device enters a timed current limit mode where the NFET is turned on for a longer duration until the inductor current falls below a low threshold, ensuring inductor current has more time to decay, thereby preventing runaway.

8.3.2.6 PFM Operation

At very light loads, the converter enters PFM mode and operates with reduced switching frequency and supply current to maintain high efficiency.

The part automatically transitions into PFM mode when either of two conditions occurs for a duration of 32 or more clock cycles:

- A. The inductor current becomes discontinuous, or
- B. The peak PMOS switch current drops below the I_{MODE} level

$$\left(\text{Typically } I_{MODE} < 66 \text{ mA} + \frac{V_{IN}}{160\Omega} \right) \quad (3)$$

Feature Description (continued)

During PFM operation, the converter positions the output voltage slightly higher than the nominal output voltage during PWM operation, allowing additional headroom for voltage drop during a load transient from light to heavy load. The PFM comparators sense the output voltage with the feedback pin and control the switching of the output FETs such that the output voltage ramps between 0.8% and 1.6% (typical) above the nominal PWM output voltage. If the output voltage is below the *low* PFM comparator threshold, the PMOS power switch is turned on. It remains on until the output voltage exceeds the 'high' PFM threshold or the peak current exceeds the I_{PFM} level set for PFM mode. The typical peak current in PFM mode is:

$$I_{PFM} = 66 \text{ mA} + \frac{V_{IN}}{80\Omega} \quad (4)$$

Once the PMOS power switch is turned off, the NMOS power switch is turned on until the inductor current ramps to zero. When the NMOS zero-current condition is detected, the NMOS power switch is turned off. If the output voltage is below the *high* PFM comparator threshold (see Figure 31), the PMOS switch is again turned on and the cycle is repeated until the output reaches the desired level. Once the output reaches the *high* PFM threshold, the NMOS switch is turned on briefly to ramp the inductor current to zero and then both output switches are turned off and the part enters an extremely low power mode. Quiescent supply current during this *sleep* mode is less than 30 μA , which allows the part to achieve high efficiencies under extremely light load conditions. When the output drops below the *low* PFM threshold, the cycle repeats to restore the output voltage to approximately 1.6% above the nominal PWM output voltage.

If the load current increases during PFM mode (see Figure 31) causing the output voltage to fall below the 'low2' PFM threshold, the part automatically transitions into fixed-frequency PWM mode.

8.3.2.7 SW1, SW2 Operation

SW1 and SW2 have selectable output voltages ranging from 0.8 V to 3.5 V (typical). Both SW1 and SW2 in the LP3907 are I²C register controlled and are enabled by default through the internal state machine of the device following a power-on event that moves the operating mode to the Active state. (See [Flexible Power Sequencing of Multiple Power Supplies](#).) The SW1 and SW2 output voltages revert to default values when the power-on sequence has been completed. The default output voltage for each buck converter is factory programmable. (See [Application and Implementation](#).)

8.3.2.8 SW1, SW2 Control Registers

SW1, SW2 can be enabled/disabled through the corresponding control register.

The Modulation mode PWM/PFM is by default automatic and depends on the load as described above in the functional description. The modulation mode can be overridden by setting I²C bit to a logic 1 in the corresponding buck control register, forcing the buck to operate in PWM mode regardless of the load condition.

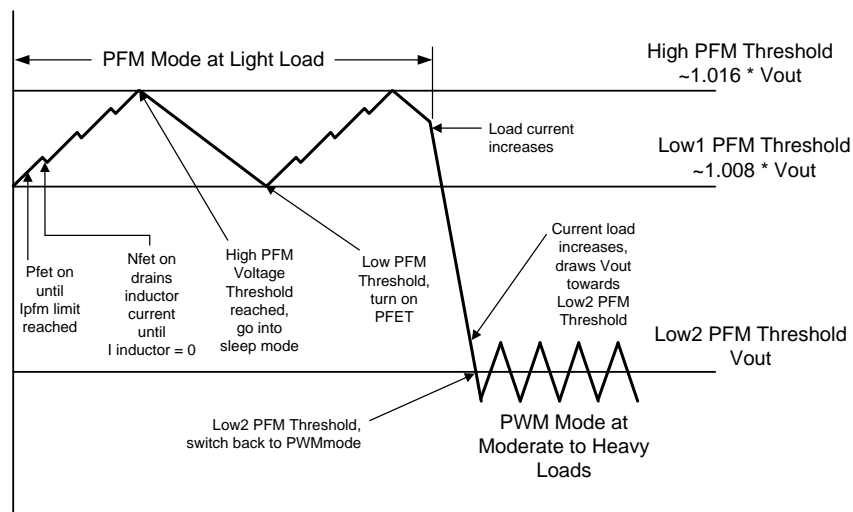

Figure 31. Operation in PFM Mode and Transfer to PWM Mode

Feature Description (continued)

8.3.2.9 Soft Start

The soft-start feature allows the power converter to gradually reach the initial steady state operating point, thus reducing start-up stresses and surges. The two LP3907 buck converters have a soft-start circuit that limits in-rush current during start-up. During start-up the switch current limit is increased in steps. Soft start is activated only if EN goes from logic low to logic high after V_{IN} reaches 2.8V. Soft start is implemented by increasing switch current limit in steps of 180 mA, 300 mA, and 720 mA for Buck1; 161 mA, 300 mA, and 536 mA for Buck2 (typical switch current limit). The start-up time thereby depends on the output capacitor and load current demanded at start-up.

8.3.2.10 Low Dropout Operation

The LP3907 can operate at 100% duty cycle (no switching; PMOS switch completely on) for low dropout support of the output voltage. In this way the output voltage is controlled down to the lowest possible input voltage. When the device operates near 100% duty cycle, output voltage ripple is approximately 25 mV. The minimum input voltage needed to support the output voltage is:

$$V_{IN, MIN} = I_{LOAD} \times (R_{DSON, PFET} + R_{INDUCTOR}) + V_{OUT}$$

where

- I_{LOAD} = Load current
 - $R_{DSON, PFET}$ = Drain to source resistance of PFET switch in the triode region
 - $R_{INDUCTOR}$ = Inductor resistance
- (5)

8.3.2.11 Flexible Power Sequencing of Multiple Power Supplies

The LP3907 provides several options for power on sequencing. The two bucks can be individually controlled with ENSW1 and ENSW2. The two LDOs can also be individually controlled with ENLDO1 and ENLDO2.

If the user desires a set power on sequence, the chip is programmable through I²C and raise EN_T from LOW to HIGH to activate the power on sequencing.

8.3.2.12 Power-Up Sequencing Using the EN_T Function

EN_T assertion causes the LP3907 to emerge from Standby mode to Full Operation mode at a preset timing sequence. By default, the enables for the LDOs and Bucks (ENLDO1, ENLDO2, EN_T, ENSW1, ENSW2) are 500 K Ω internally pulled down, which causes the part to stay OFF until enabled. If the user wishes to use the preset timing sequence to power on the regulators, transition the EN_T pin from Low to High. Otherwise, simply tie the enables of each specific regulator HIGH to turn on automatically.

EN_T is edge triggered with rising edge signaling the chip to power on. The EN_T input is deglitched, and the default is set at 1 ms. As shown in [Figure 32](#) and [Figure 33](#), a rising EN_T edge starts a power-on sequence, while a falling EN_T edge starts a shutdown sequence. If EN_T is high, toggling the external enables of the regulators has no effect on the chip.

The regulators can also be programmed through I²C to turn on and off. By default, I²C enables for the regulators turned ON.

The regulators are on following the pattern below:

Regulators on = (I²C enable) AND (External pin enable OR EN_T high).

NOTE

The EN_T power-up sequencing may also be employed immediately after V_{IN} is applied to the device. However, V_{IN} must be stable for approximately 8 ms minimum before EN_T be asserted high to ensure internal bias, reference, and the Flexible POR timing are stabilized. This initial EN_T delay is necessary only upon first time device power on for power sequencing function to operate properly. If the device is powered, the EN_T logic must be stable for 12 ms minimum before switching state.

Feature Description (continued)

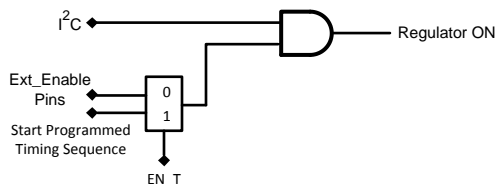

Figure 32. Power Rail Enable Logic

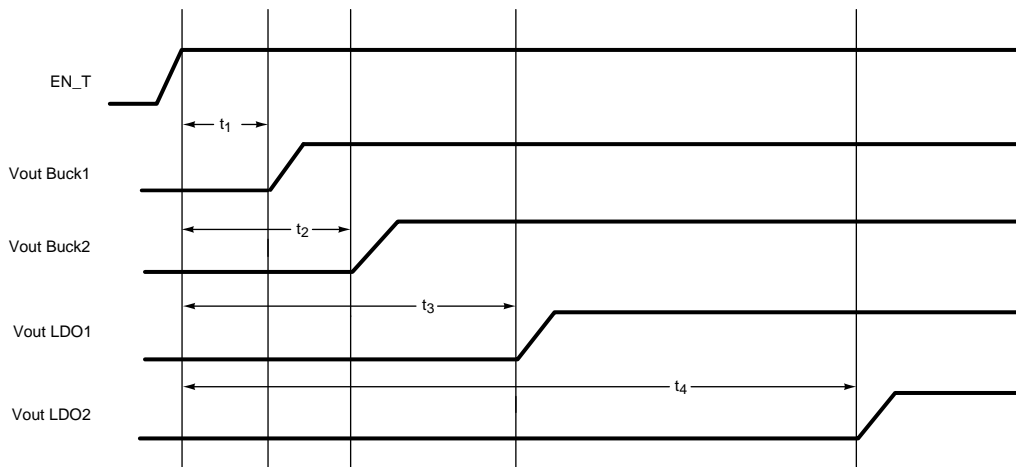

Figure 33. LP3907 Default Power-Up Sequence

Table 5. Power-On Timing Specification

	DESCRIPTION	MIN	NOM	TYP	UNIT
t ₁	Programmable delay from EN_T assertion to V _{CC} -Buck1 On		1.5		ms
t ₂	Programmable delay from EN_T assertion to V _{CC} -Buck2 On		2		ms
t ₃	Programmable delay from EN_T assertion to V _{CC} -LDO1 On		3		ms
t ₄	Programmable delay from EN_T assertion to V _{CC} -LDO2 On		6		ms

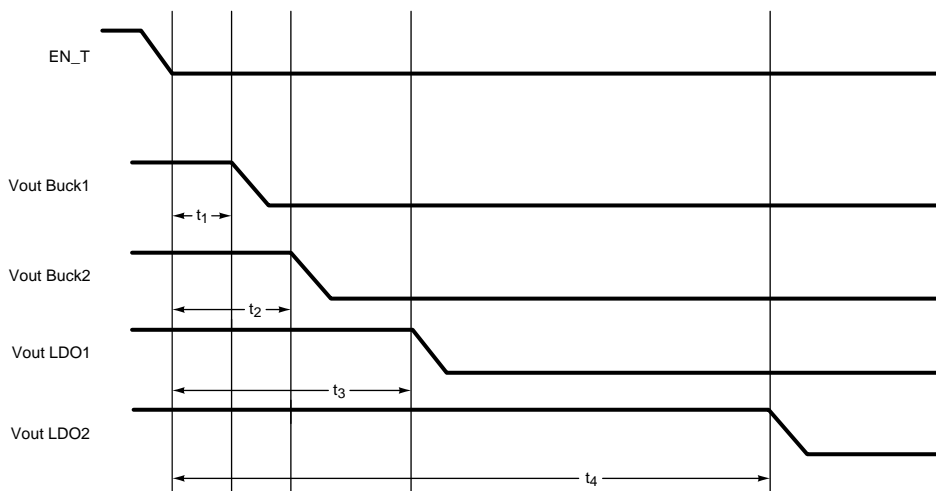

Figure 34. LP3907 Default Power-Off Sequence

Table 6. Power-Off Timing Specification

	DESCRIPTION	MIN	NOM	MAX	UNIT
t_1	Programmable delay from EN_T deassertion to V_{CC_Buck1} Off		1.5		ms
t_2	Programmable delay from EN_T deassertion to V_{CC_Buck2} Off		2		ms
t_3	Programmable delay from EN_T deassertion to V_{CC_LDO1} Off		3		ms
t_4	Programmable delay from EN_T deassertion to V_{CC_LDO2} Off		6		ms

8.3.3 Flexible Power-On Reset (Power Good with Delay)

The LP3907 is equipped with an internal power-on-reset (POR) circuit which monitors the output voltage levels on Bucks 1 and 2. The nPOR is an open drain logic output which is logic LOW when either of the buck outputs are below 91% of the rising value, or when one or both outputs fall below 82% of the desired value. The time delay between output voltage level and nPOR is enabled is (50 μ s, 50 ms, 100 ms, 200 ms) 50 ms by default. The system designer can choose the external pullup resistor (that is, 100 k Ω) for the nPOR pin.

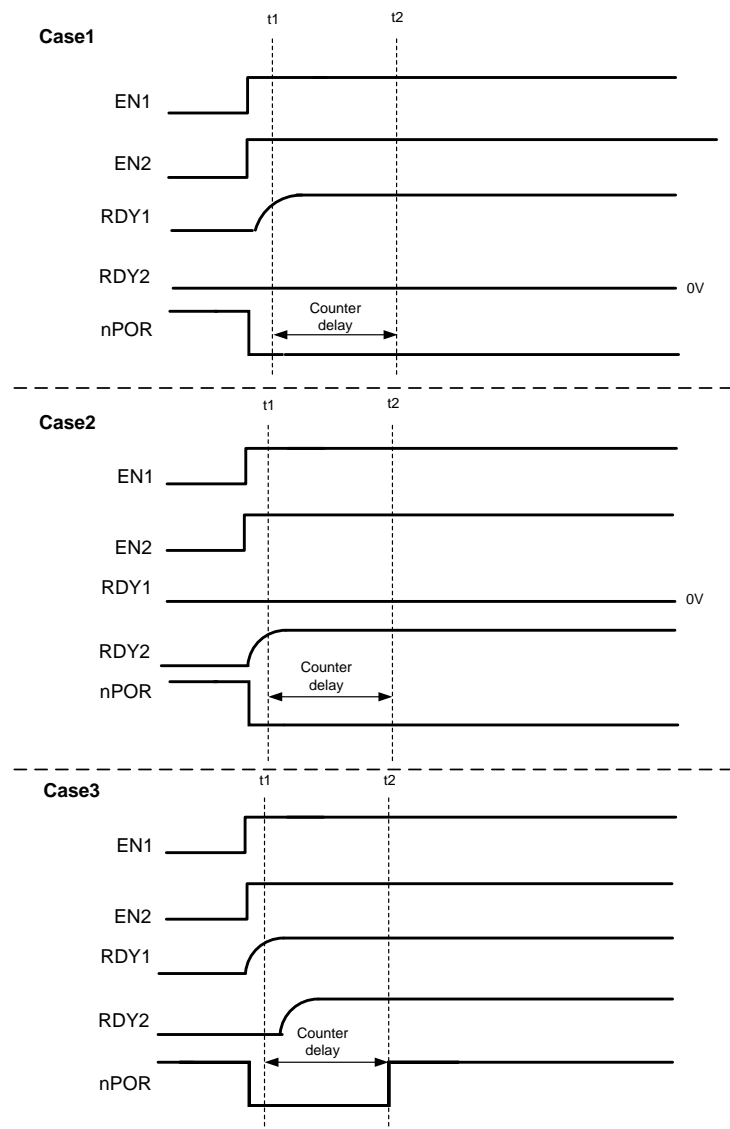

Figure 35. nPOR with Counter Delay

Figure 35 shows the simplest application of the POR, where both switcher enables are tied together. In Case 1, EN1 causes nPOR to transition LOW and triggers the nPOR delay counter. If the power supply for Buck2 does not come on within that period, nPOR stays LOW, indicating a power fail mode. Case 2 indicates the vice versa scenario if Buck1 supply did not come on. In both cases the nPOR remains LOW.

Case 3 shows a typical application of the POR, where both switcher enables are tied together. Even if RDY1 ramps up slightly faster than RDY2 (or vice versa), then nPOR signal triggers a programmable delay before going HIGH, as explained below.

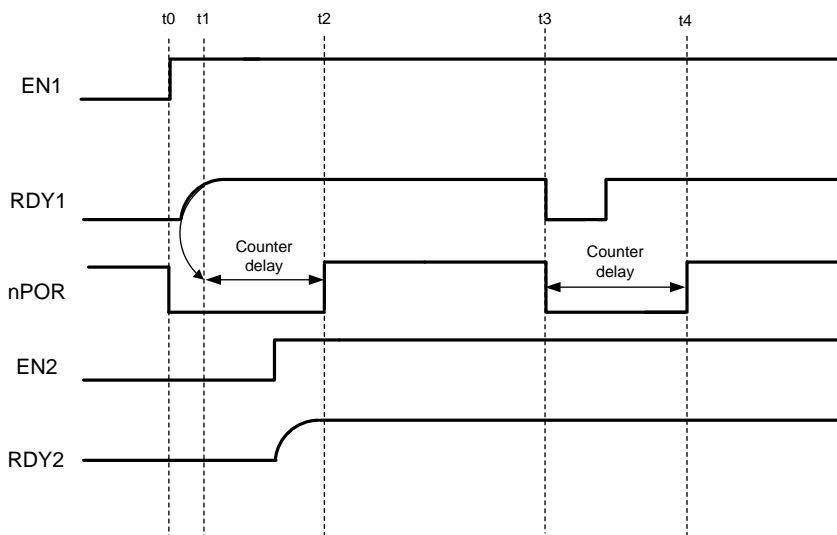

Figure 36. Faults Occurring in Counter Delay After Start-Up

Figure 36 details the power good with delay with respect to the enable signals EN1, and EN2. The RDY1, RDY2 are internal signals derived from the output of two comparators. Each comparator has been trimmed as follows:

COMPARATOR LEVEL	BUCK SUPPLY LEVEL
HIGH	Greater than 94%
LOW	Less than 85%

The circuits for EN1 and RDY1 is symmetrical to EN2 and RDY2, so each reference to EN1 and RDY1 also works for EN2 and RDY2 and vice versa.

If EN1 and RDY1 signals are High at time t1, then the RDY1 signal rising edge triggers the programmable delay counter (50 μs, 50 ms, 100 ms, 200 ms). This delay forces nPOR LOW between time interval t1 and t2. nPOR is then pulled high after the programmable delay is completed. Now if EN2 and RDY2 are initiated during this interval the nPOR signal ignores this event.

If either RDY1 or RDY2 were to go LOW at t3 then the programmable delay is triggered again.

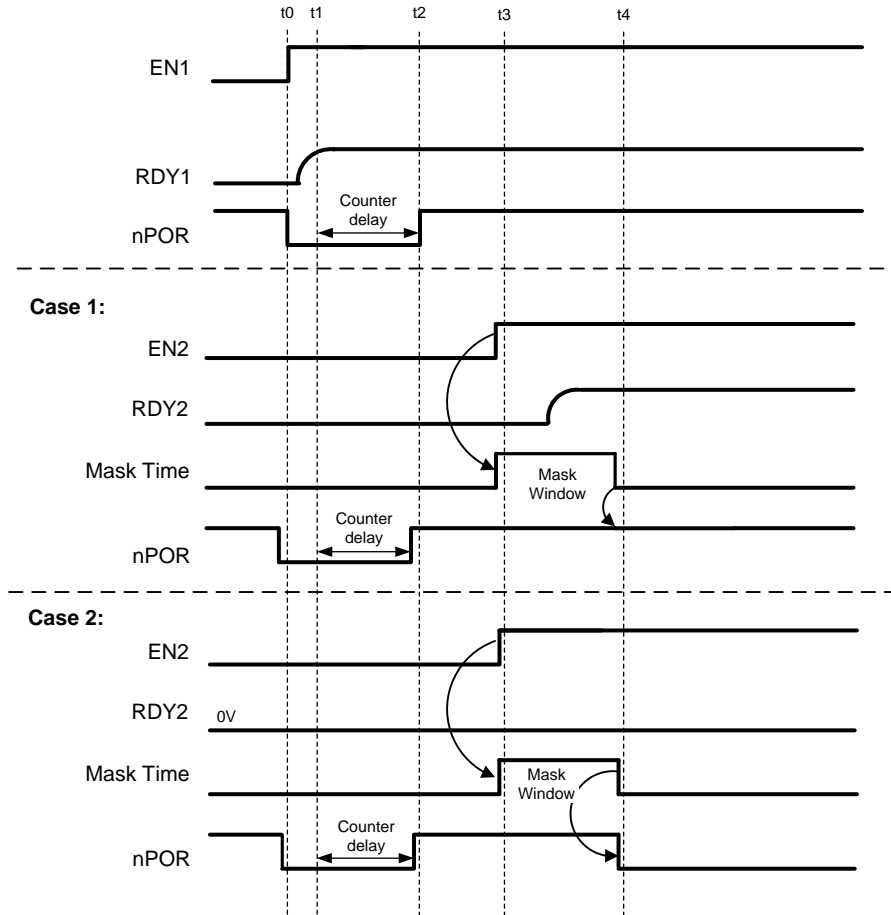

Figure 37. nPOR Mask Window

If the EN1 and RDY1 are initiated in normal operation, then nPOR is asserted and deasserted as explained in [Figure 37](#).

Case 1 shows the case where EN2 and RDY2 are initiated after triggered programmable delay. To prevent the nPOR being asserted again, a masked window (5 ms) counter delay is triggered off the EN2 rising edge. nPOR is still held HIGH for the duration of the mask, whereupon the nPOR status afterwards depends on the status of both RDY1 and RDY2 lines.

Case 2 shows the case where EN2 is initiated after the RDY1 triggered programmable delay, but RDY2 never goes HIGH (Buck2 never turns on). Normal operation operation of nPOR occurs with respect to EN1 and RDY1, and the nPOR signal is held HIGH for the duration of the mask window. We see that nPOR goes LOW after the masking window has timed out because it is now dependent on RDY1 and RDY2, where RDY2 is LOW.

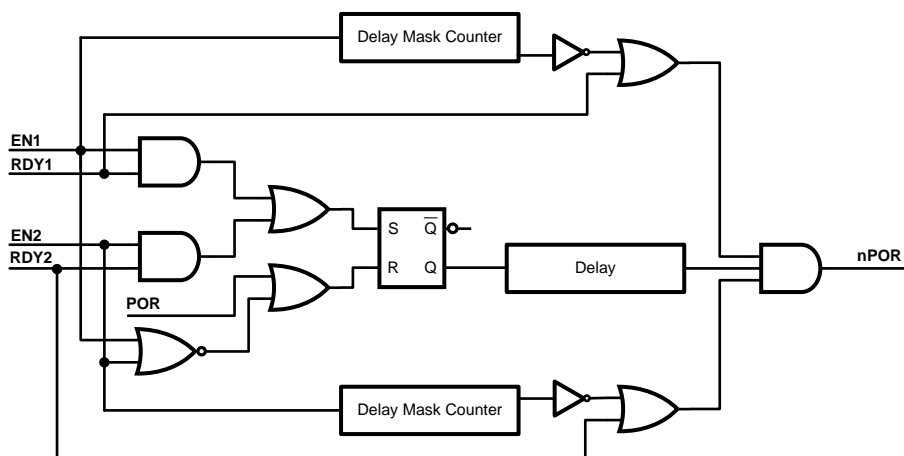

Figure 38. Design Implementation of the Flexible Power-On Reset

An internal power-on reset of the device is used with EN1, and EN2 to produce a reset signal (LOW) to the delay timer nPOR. EN1 and RDY1 or EN2 and RDY2 are used to generate the set signal (HIGH) to the delay timer. S = R = 1 never occurs. The mask timers are triggered off EN1 and EN2 which are gated with RDY1, and RDY2 to generate outputs to the final AND gate to generate the nPOR.

8.3.4 Undervoltage Lockout

The LP3907 features an undervoltage lockout circuit. The function of this circuit is to continuously monitor the raw input supply voltage (VINLDO12) and automatically disables the four voltage regulators whenever this supply voltage is less than 2.8 VDC.

The circuit incorporates a bandgap based circuit that establishes the reference used to determine the 2.8 VDC trip point for a V_{IN} OK – Not OK detector. This V_{IN} OK signal is then used to gate the enable signals to the four regulators of the device. When VINLDO12 is greater than 2.8 VDC the four enables control the four regulators, when VINLDO12 is less than 2.8 VDC the four regulators are disabled by the V_{IN} detector being in the “Not OK” state. The circuit has built-in hysteresis to prevent chattering occurring.

8.4 Device Functional Modes

8.4.1 Shutdown Mode

During shutdown the PFET switch, reference, control and bias circuitry of the converters are turned off. The NFET switch is on in shutdown to discharge the output. When the converter is enabled, soft start is activated. It is recommended to disable the converter during the system power up and undervoltage conditions when the supply is less than 2.8 V.

8.5 Programming

8.5.1 I²C-Compatible Serial Interface

8.5.1.1 I²C Signals

The LP3907 features an I²C-compatible serial interface, using two dedicated pins: SCL and SDA for I²C clock and data respectively. Both signals need a pullup resistor according to the I²C specification. The LP3907 interface is an I²C slave that is clocked by the incoming SCL clock.

Signal timing specifications are according to the I²C bus specification. The maximum bit rate is 400kbit/s. See I²C specification from NXP Semiconductors for further details.

8.5.1.2 I²C Data Validity

The data on the SDA line must be stable during the HIGH period of the clock signal (SCL); for example, the state of the data line can only be changed when CLK is LOW.

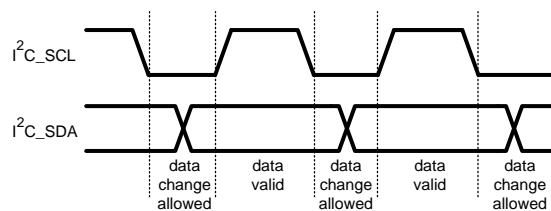

Figure 39. I²C Signals: Data Validity

8.5.1.3 I²C Start and Stop Conditions

START and STOP bits classify the beginning and the end of the I²C session. START condition is defined as the SDA signal transitioning from HIGH to LOW while the SCL line is HIGH. STOP condition is defined as the SDA transitioning from LOW to HIGH while the SCL is HIGH. The I²C master always generates START and STOP bits. The I²C bus is considered to be busy after START condition and free after STOP condition. During data transmission, I²C master can generate repeated START conditions. First START and repeated START conditions are equivalent, function-wise.

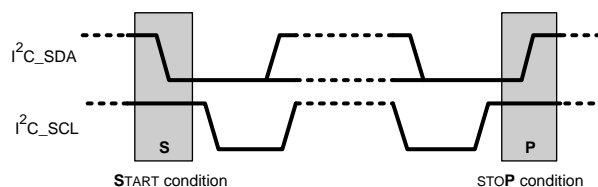

Figure 40. Start and Stop Conditions

8.5.1.4 Transferring Data

Every byte put on the SDA line must be eight bits long, with the most significant bit (MSB) being transferred first. Each byte of data has to be followed by an acknowledge bit. The acknowledged related clock pulse is generated by the master. The transmitter releases the SDA line (HIGH) during the acknowledge clock pulse. The receiver must pull down the SDA line during the 9th clock pulse, signifying acknowledgment. A receiver which has been addressed must generate an acknowledgment (“ACK”) after each byte has been received.

After the START condition, the I²C master sends a chip address. This address is seven bits long followed by an eighth bit which is a data direction bit (R/W).

Programming (continued)

NOTE

According to industry I²C standards for 7-bit addresses, the MSB of an 8-bit address is removed, and communication actually starts with the 7th most significant bit. For the eighth bit (LSB), a “0” indicates a WRITE and a “1” indicates a READ. The second byte selects the register to which the data is written. The third byte contains data to write to the selected register.

The LP3907 has factory-programmed I²C addresses. The WQFN chip has a chip address of 60'h, while the DSBGA chip has a chip address of 61'h.



Figure 41. I²C Chip Address (see note above)

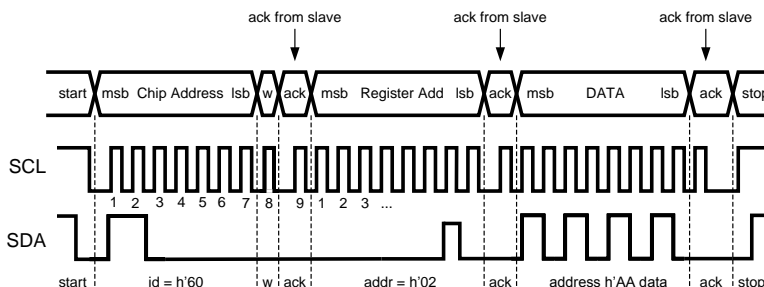

w = write (SDA = “0”)
 r = read (SDA = “1”)
 ack = acknowledge (SDA pulled down by either master or slave)
 rs = repeated start
 id = LP3907 WQFN chip address: **0x60**; DSBGA chip address: **0x61**

Figure 42. I²C Write Cycle

When a READ function is to be accomplished, a WRITE function must precede the READ function, as shown in the Read Cycle waveform.

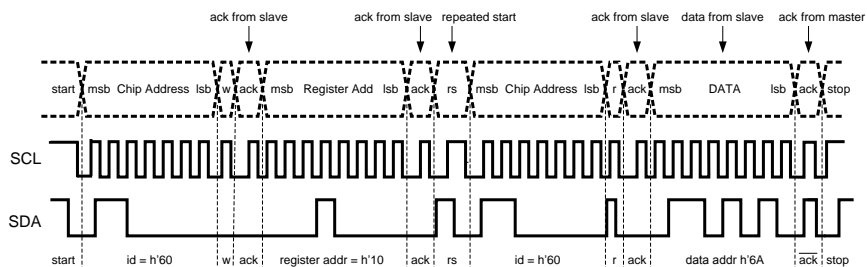

Figure 43. I²C Read Cycle

Programming (continued)

8.5.2 Factory Programmable Options

[Table 7](#) shows options EPROM programmed during final test of the LP3907. The system designer that needs specific options is advised to contact the TI sales office.

Table 7. Factory-Programmable Options

FACTORY PROGRAMMABLE OPTIONS	CURRENT VALUE
Enable delay for power on	code 010 (see Control 1 Register (SCR1) 0x07)
SW1 ramp speed	8 mV/μs
SW2 ramp speed	8 mV/μs

The I²C Chip ID address is offered as a metal mask option. The current address for the WQFN chip equals 0x60, while the address for the DSBGA chip is 0x61.

8.6 Register Maps

8.6.1 LP3907 Control Registers

REGISTER ADDRESS	REGISTER NAME	READ/WRITE	REGISTER DESCRIPTION
0x02	ICRA	R	Interrupt Status Register A
0x07	SCR1	R/W	System Control 1 Register
0x10	BKLDONEN	R/W	Buck and LDO Output Voltage Enable Register
0x11	BKLDOSR	R	Buck and LDO Output Voltage Status Register
0x20	VCCR	R/W	Voltage Change Control Register 1
0x23	B1TV1	R/W	Buck1 Target Voltage 1 Register
0x24	B1TV2	R/W	Buck1 Target Voltage 2 Register
0x25	B1RC	R/W	Buck1 Ramp Control
0x29	B2TV1	R/W	Buck2 Target Voltage 1 Register
0x2A	B2TV2	R/W	Buck2 Target Voltage 2 Register
0x2B	B2RC	R/W	Buck2 Ramp Control
0x38	BFCR	R/W	Buck Function Register
0x39	LDO1VCR	R/W	LDO1 Voltage Control Registers
0x3A	LDO2VCR	R/W	LDO2 Voltage Control Registers

8.6.1.1 Interrupt Status Register (ISRA) 0x02

This register informs the System Engineer of the temperature status of the chip.

	D7-D2	D1	D0
Name	—	Temp 125°C	—
Access	—	R	—
Data	Reserved	Status bit for thermal warning PMIC T>125°C 0 – PMIC Temp. < 125°C 1 – PMIC Temp. > 125°C	Reserved
Reset	0	0	0

8.6.1.2 Control 1 Register (SCR1) 0x07

This register allows the user to select the preset delay sequence for power-on timing, to switch between PFM and PWM mode for the bucks, and also to select between an internal and external clock for the bucks.

	D7	D6-D4	D3	D2	D1	D0
Name	—	EN_DLY	—	FPWM2	FPWM1	ECEN
Access	—	R/W	—	R/W	R/W	R/W
Data	Reserved	Selects the preset delay sequence from EN_T assertion (shown below)	Reserved	Buck2 PWM /PFM Mode select 0 – Auto Switch PFM - PWM operation 1 – PWM Mode Only	Buck 1 PWM /PFM Mode select 0 – Auto Switch PFM - PWM operation 1 – PWM Mode Only	Reserved
Reset	0	Factory-Programmed Default	1	Factory-Programmed Default	Factory-Programmed Default	0

8.6.1.3 EN_DLY Preset Delay Sequence After EN_T Assertion

EN_DLY<2:0>	DELAY (ms)			
	BUCK1	BUCK2	LDO1	LDO2
000	1	1	1	1
001	1	1.5	2	2
010	1.5	2	3	6
011	1.5	2	1	1
100	1.5	2	3	6
101	1.5	1.5	2	2
110	3	2	1	1.5
111	2	3	6	11

8.6.1.4 Buck and LDO Output Voltage Enable Register (BKLD0EN) – 0x10

This register controls the enables for the Bucks and LDOs.

	D7	D6	D5	D4	D3	D2	D1	D0
Name	—	LDO2EN	—	LDO1EN	—	BK2EN	—	BK1EN
Access	—	R/W	—	R/W	—	R/W	—	R/W
Data	Reserved	0 – Disable 1 – Enable	Reserved	0 – Disable 1 – Enable	Reserved	0 – Disable 1 – Enable	Reserved	0 – Disable 1 – Enable
Reset	0	1	1	1	0	1	0	1

8.6.1.5 Buck and LDO Status Register (BKLDOSR) – 0x11

This register monitors whether the Bucks and LDOs meet the voltage output specifications.

	D7	D6	D5	D4	D3	D2	D1	D0
Name	BKS_OK	LDOS_OK	LDO2_OK	LDO1_OK	—	BK2_OK	—	BK1_OK
Access	R	R	R	R	—	R	—	R
Data	0 – Buck 1-2 Not Valid 1 – Bucks Valid	0 – LDO 1-2 Not Valid 1 – LDOs Valid	0 – LDO2 Not Valid 1 – LDO2 Valid	0 – LDO1 Not Valid 1 – LDO1 Valid	Reserved	0 – Buck2 Not Valid 1 – Buck2 Valid	Reserved	0 – Buck1 Not Valid 1 – Buck1 Valid
Reset	0	0	0	0	0	0	0	0

8.6.1.6 Buck Voltage Change Control Register 1 (VCCR) – 0x20

This register selects and controls the output target voltages for the buck regulators.

	D7-6	D5	D4	D3-2	D1	D0
Name	—	B2VS	B2GO	—	B1VS	B1GO
Access	—	R/W	R/W	—	R/W	R/W
Data	Reserved	Buck2 Target Voltage Select 0 – B2VT1 1 – B2VT2	Buck2 Voltage Ramp CTRL 0 – Hold 1 – Ramp to B2VS selection	Reserved	Buck1 Target Voltage Select 0 – B1VT1 1 – B1VT2	Buck1 Voltage Ramp CTRL 0 – Hold 1 – Ramp to B1VS selection
Reset	00	0	0	00	0	0

8.6.1.7 Buck1 Target Voltage 1 Register (B1TV1) – 0x23

This register allows the user to program the output target voltage of Buck1.

	D7-D5	D4-D0
Name	—	BK1_VOUT1
Access	—	R/W
Data	Reserved	Buck1 Output Voltage (V)
		5'h00 Ext Ctrl
		5'h01 0.80
		5'h02 0.85
		5'h03 0.90
		5'h04 0.95
		5'h05 1.00
		5'h06 1.05
		5'h07 1.10
		5'h08 1.15
		5'h09 1.20
		5'h0A 1.25
		5'h0B 1.30
		5'h0C 1.35
		5'h0D 1.40
		5'h0E 1.45
		5'h0F 1.50
		5'h10 1.55
		5'h11 1.60
		5'h12 1.65
		5'h13 1.70
		5'h14 1.75
		5'h15 1.80
		5'h16 1.85
		5'h17 1.90
		5'h18 1.95
		5'h19 2.00
		5'h1A–5'h1F 2.00
Reset	000	Factory-Programmed Default

8.6.1.8 Buck1 Target Voltage 2 Register (B1TV2) – 0x24

This register allows the user to program the output target voltage of Buck1.

	D7-D5	D4-D0
Name	—	BK1_VOUT2
Access	—	R/W
Data	Reserved	Buck1 Output Voltage (V)
		5'h00 Ext Ctrl ⁽¹⁾
		5'h01 0.80
		5'h02 0.85
		5'h03 0.90
		5'h04 0.95
		5'h05 1.00
		5'h06 1.05
		5'h07 1.10
		5'h08 1.15
		5'h09 1.20
		5'h0A 1.25
		5'h0B 1.30
		5'h0C 1.35
		5'h0D 1.40
		5'h0E 1.45
		5'h0F 1.50
		5'h10 1.55
		5'h11 1.60
		5'h12 1.65
		5'h13 1.70
		5'h14 1.75
		5'h15 1.80
		5'h16 1.85
		5'h17 1.90
		5'h18 1.95
		5'h19 2.00
		5'h1A–5'h1F 2.00
Reset	000	Factory-Programmed Default

(1) If using Ext Ctrl, contact TI Sales for support.

8.6.1.9 Buck1 Ramp Control Register (B1RC) - 0x25

This register allows the user to program the rate of change between the target voltages of Buck1.

	D7	D6-D4	D3-D0	
Name	----	----	B1RS	
Access	----	----	R/W	
Data	Reserved	Reserved	Data Code	Ramp Rate mV/us
			4h'0	Instant
			4h'1	1
			4h'2	2
			4h'3	3
			4h'4	4
			4h'5	5
			4h'6	6
			4h'7	7
			4h'8	8
			4h'9	9
			4h'A	10
4h'B - 4h'F	10			
Reset	0	010	1000	

8.6.1.10 Buck2 Target Voltage 1 Register (B2TV1) – 0x29

This register allows the user to program the output target voltage of Buck2.

	D7-D5	D4-D0
Name	—	BK2_VOUT1
Access	—	R/W
Data	Reserved	Buck2 Output Voltage (V)
		Ext Ctrl
		5'h00 1.0
		5'h01 1.1
		5'h02 1.2
		5'h03 1.3
		5'h04 1.4
		5'h05 1.5
		5'h06 1.6
		5'h07 1.7
		5'h08 1.8
		5'h09 1.9
		5'h0A 2.0
		5'h0B 2.1
		5'h0C 2.2
		5'h0D 2.4
		5'h0E 2.5
		5'h0F 2.6
		5'h10 2.7
		5'h11 2.8
		5'h12 2.9
		5'h13 3.0
		5'h14 3.1
		5'h15 3.2
		5'h16 3.3
		5'h17 3.4
		5'h18 3.5
		5'h19 3.5
		5'h1A–5'h1F 3.5
Reset	000	Factory-Programmed Default

8.6.1.11 Buck2 Target Voltage 2 Register (B2TV2) – 0x2A

This register allows the user to program the output target voltage of Buck2.

	D7-5	D4-0
Name	—	BK2_VOUT2
Access	—	R/W
Data	Reserved	Buck2 Output Voltage (V)
		5'h00 Ext Ctrl ⁽¹⁾
		5'h01 1.0
		5'h02 1.1
		5'h03 1.2
		5'h04 1.3
		5'h05 1.4
		5'h06 1.5
		5'h07 1.6
		5'h08 1.7
		5'h09 1.8
		5'h0A 1.9
		5'h0B 2.0
		5'h0C 2.1
		5'h0D 2.2
		5'h0E 2.4
		5'h0F 2.5
		5'h10 2.6
		5'h11 2.7
		5'h12 2.8
		5'h13 2.9
		5'h14 3.0
		5'h15 3.1
		5'h16 3.2
		5'h17 3.3
		5'h18 3.4
		5'h19 3.5
		5'h1A–5'h1F 3.5
Reset	000	Factory-Programmed Default

(1) If using Ext Ctrl, contact TI Sales for support.

8.6.1.12 Buck2 Ramp Control Register (B2RC) - 0x2B

This register allows the user to program the rate of change between the target voltages of Buck2.

	D7	D6-D4	D3-D0	
Name	----	----	B2RS	
Access	----	----	R/W	
Data	Reserved	Reserved	Data Code	Ramp Rate mV/us
			4h'0	Instant
			4h'1	1
			4h'2	2
			4h'3	3
			4h'4	4
			4h'5	5
			4h'6	6
			4h'7	7
			4h'8	8
			4h'9	9
			4h'A	10
4h'B - 4h'F	10			
Reset	0	010	1000	

8.6.1.13 Buck Function Register (BFCR) – 0x38

This register allows the Buck switcher clock frequency to be spread across a wider range, allowing for less Electro-magnetic Interference (EMI). The spread spectrum modulation frequency refers to the rate at which the frequency ramps up and down, centered at 2 MHz.

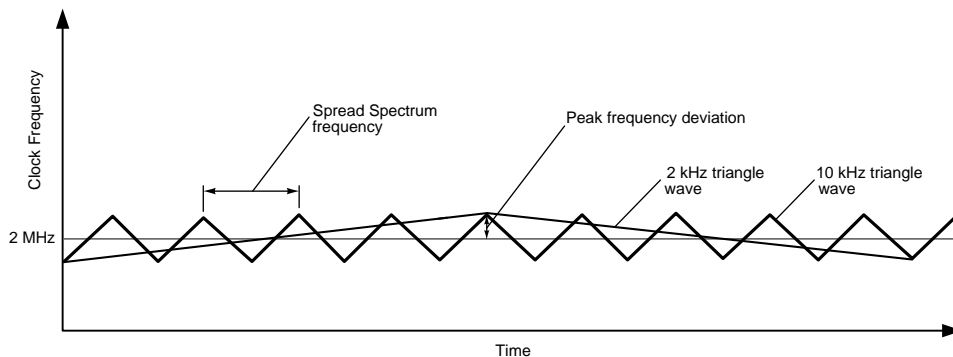

Figure 44. Spread Spectrum Modulation Frequency

This register also allows dynamic scaling of the nPOR Delay Timing. The LP3907 is equipped with an internal POR circuit which monitors the output voltage levels on the buck regulators, allowing the user to more actively monitor the power status of the chip.

The UVLO feature continuously monitor the raw input supply voltage (VINLDO12) and automatically disables the four voltage regulators whenever this supply voltage is less than 2.8 VDC. This prevents the user from damaging the power source (such as battery), but can be disabled if the user wishes.

Note that if the supply to VDD_M is close to 2.8 V with a heavy load current on the regulators, the chip is in danger of powering down due to UVLO. If the user wishes to keep the chip active under those conditions, enable the Bypass UVLO feature.

	D7-D5	D4	D3-D2	D1	D0
Name	—	BP_UVLO	TPOR	BK_SLOMOD	BK_SSEN
Access	—	R/W	R/w	R/W	R/W
Data	Reserved	Bypass UVLO monitoring 0 - Allow UVLO 1 - Disable UVLO	nPOR Delay Timing 00 - 50 μ s 01 - 50 ms 10 - 100 ms 11 - 200 ms	Buck Spread Spectrum Modulation 0 – 10 kHz triangular wave 1 – 2 kHz triangular wave	Spread Spectrum Function Output 0 – Disabled 1 – Enabled
Reset	000	Factory-Programmed Default	01	1	0

8.6.1.14 LDO1 Control Register (LDO1VCR) – 0x39

This register allows the user to program the output target voltage of LDO 1.

For “JJ11” voltage options LDO1 has a fixed output voltage of 2.85 V.

	D7-D5	D4-D0
Name	—	LDO1_OUT
Access	—	R/W
Data	Reserved	LDO1 Output voltage (V)
		5'h00 1.0
		5'h01 1.1
		5'h02 1.2
		5'h03 1.3
		5'h04 1.4
		5'h05 1.5
		5'h06 1.6
		5'h07 1.7
		5'h08 1.8
		5'h09 1.9
		5'h0A 2.0
		5'h0B 2.1
		5'h0C 2.2
		5'h0D 2.3
		5'h0E 2.4
		5'h0F 2.5
		5'h10 2.6
		5'h11 2.7
		5'h12 2.8
		5'h13 2.9
		5'h14 3.0
		5'h15 3.1
		5'h16 3.2
		5'h17 3.3
		5'h18 3.4
		5'h19 3.5
		5'h1A–5'h1F 3.5
Reset	000	Factory-Programmed Default

8.6.1.15 LDO2 Control Register (LDO2VCR) – 0x3A

This register allows the user to program the output target voltage of LDO 2.

For “JJ11” voltage options LDO2 has a fixed output voltage of 2.85 V.

	D7-D5	D4-D0
Name	—	LDO2_OUT
Access	—	R/W
Data	Reserved	LDO2 Output voltage (V)
		5'h00 1.0
		5'h01 1.1
		5'h02 1.2
		5'h03 1.3
		5'h04 1.4
		5'h05 1.5
		5'h06 1.6
		5'h07 1.7
		5'h08 1.8
		5'h09 1.9
		5'h0A 2.0
		5'h0B 2.1
		5'h0C 2.2
		5'h0D 2.3
		5'h0E 2.4
		5'h0F 2.5
		5'h10 2.6
		5'h11 2.7
		5'h12 2.8
		5'h13 2.9
		5'h14 3.0
		5'h15 3.1
		5'h16 3.2
		5'h17 3.3
		5'h18 3.4
		5'h19 3.5
		5'h1A–5'h1F 3.5
Reset	000	Factory-Programmed Default

9 Application and Implementation

NOTE

Information in the following applications sections is not part of the TI component specification, and TI does not warrant its accuracy or completeness. TI's customers are responsible for determining suitability of components for their purposes. Customers should validate and test their design implementation to confirm system functionality.

9.1 Application Information

The LP3907 provides three control methods to turn ON/OFF four power rails:

1. EN_T Control: Provides pre-defined power up/down sequence. (Note: V_{IN} /Battery voltage must be settled approximately 8 ms, minimum, before EN_T be asserted high).
2. Individual GPIO/EN pin control: four EN pins provide max control flexibility without I^2C .
3. I^2C control: besides simple ON/OFF control, also provides access to all the user programmable registers.

See [Register Maps](#) for details.

9.2 Typical Application

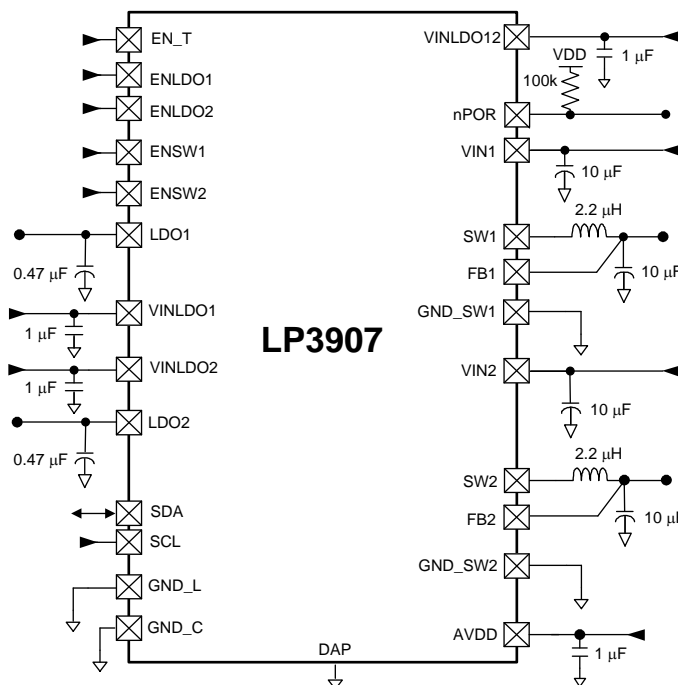

Copyright © 2016, Texas Instruments Incorporated

Figure 45. LP3907 Typical Application

9.2.1 Design Requirements

Ten ceramic capacitors and two inductors are required for this application. These three external components must be selected very carefully for property operation. See [Detailed Design Procedure](#).

Typical Application (continued)

9.2.2 Detailed Design Procedure

9.2.2.1 Custom Design With WEBENCH® Tools

Click [here](#) to create a custom design using the LP3907 device with the WEBENCH® Power Designer.

1. Start by entering the input voltage (V_{IN}), output voltage (V_{OUT}), and output current (I_{OUT}) requirements.
2. Optimize the design for key parameters such as efficiency, footprint, and cost using the optimizer dial.
3. Compare the generated design with other possible solutions from Texas Instruments.

The WEBENCH Power Designer provides a customized schematic along with a list of materials with real-time pricing and component availability.

In most cases, these actions are available:

- Run electrical simulations to see important waveforms and circuit performance
- Run thermal simulations to understand board thermal performance
- Export customized schematic and layout into popular CAD formats
- Print PDF reports for the design, and share the design with colleagues

Get more information about WEBENCH tools at www.ti.com/WEBENCH.

9.2.2.2 Component Selection

9.2.2.2.1 Inductors for SW1 And SW2

There are two main considerations when choosing an inductor; the inductor must not saturate and the inductor current ripple is small enough to achieve the desired output voltage ripple. Care must be taken when reviewing the different saturation current ratings that are specified by different manufacturers. Saturation current ratings are typically specified at 25°C, so ratings at maximum ambient temperature of the application must be requested from the manufacturer.

There are two methods to choose the inductor saturation current rating:

9.2.2.2.1.1 Method 1:

The saturation current is greater than the sum of the maximum load current and the worst case average-to-peak inductor current. This can be written as follows:

$$I_{sat} > I_{outmax} + I_{ripple}$$

$$\text{where } I_{ripple} = \left(\frac{1}{f}\right) \times \left(\frac{V_{IN} - V_{OUT}}{2L}\right) \times \left(\frac{V_{OUT}}{V_{IN}}\right)$$

where

- I_{RIPPLE} = Maximum load current
- I_{OUTMAX} = Average to peak inductor current
- V_{IN} = Maximum input voltage to the buck
- L = Min inductor value including worse case tolerances (30% drop can be considered for method 1)
- f = Minimum switching frequency (1.6 MHz)
- V_{OUT} = Buck output voltage

(6)

9.2.2.2.1.2 Method 2:

A more conservative and recommended approach is to choose an inductor that has saturation current rating greater than the maximum current limit of 1250 mA for Buck1 and 1750 mA for Buck2.

Given a peak-to-peak current ripple (I_{PP}) the inductor needs to be at least

$$L \geq \left(\frac{V_{IN} - V_{OUT}}{I_{PP}}\right) \times \left(\frac{V_{OUT}}{V_{IN}}\right) \times \left(\frac{1}{f}\right)$$

(7)

Typical Application (continued)

Table 8. Suggested Inductor Values

INDUCTOR	VALUE (μH)	DESCRIPTION	NOTES
$L_{\text{SW}1,2}$	2.2	SW1,2 inductor	DCR: 70 m Ω

9.2.2.2.2 External Capacitors

The regulators on the LP3907 require external capacitors for regulator stability. These are specifically designed for portable applications requiring minimum board space and smallest components. These capacitors must be correctly selected for good performance.

9.2.2.3 LDO Capacitor Selection

9.2.2.3.1 Input Capacitor

An input capacitor is required for stability. It is recommended that a 1- μF capacitor be connected between the LDO input pin and ground (this capacitance value may be increased without limit).

This capacitor must be located a distance of not more than 1 cm from the input pin and returned to a clean analog ground. Any good quality ceramic, tantalum, or film capacitor may be used at the input.

Important: Tantalum capacitors can suffer catastrophic failures due to surge currents when connected to a low impedance source of power (such as a battery or a very large capacitor). If a tantalum capacitor is used at the input, it must be ensured by the manufacturer to have a surge current rating sufficient for the application.

There are no requirements for the equivalent series resistance (ESR) on the input capacitor, but tolerance and temperature coefficient must be considered when selecting the capacitor to ensure the capacitance remains approximately 1 μF over the entire operating temperature range.

9.2.2.3.2 Output Capacitor

The LDOs on the LP3907 are designed specifically to work with very small ceramic output capacitors. A 0.47- μF ceramic capacitor (temperature types Z5U, Y5V or X7R) with ESR between 5 m Ω to 500 m Ω , is suitable in the application circuit.

It is also possible to use tantalum or film capacitors at the device output, C_{OUT} (or V_{OUT}), but these are not as attractive for reasons of size and cost.

The output capacitor must meet the requirement for the minimum value of capacitance and also have an ESR value that is within the range 5 m Ω to 500 m Ω for stability.

9.2.2.3.3 Capacitor Characteristics

The LDOs are designed to work with ceramic capacitors on the output to take advantage of the benefits they offer. For capacitance values in the range of 0.47 μF to 4.7 μF , ceramic capacitors are the smallest, least expensive and have the lowest ESR values, thus making them best for eliminating high frequency noise. The ESR of a typical 1- μF ceramic capacitor is in the range of 20 m Ω to 40 m Ω , which easily meets the ESR requirement for stability for the LDOs.

For both input and output capacitors, careful interpretation of the capacitor specification is required to ensure correct device operation. The capacitor value can change greatly, depending on the operating conditions and capacitor type.

In particular, the output capacitor selection should take account of all the capacitor parameters, to ensure that the specification is met within the application. The capacitance can vary with DC bias conditions as well as temperature and frequency of operation. Capacitor values will also show some decrease over time due to aging. The capacitor parameters are also dependent on the particular case size, with smaller sizes giving poorer performance figures in general. As an example, [Figure 46](#) is a typical graph comparing different capacitor case sizes.

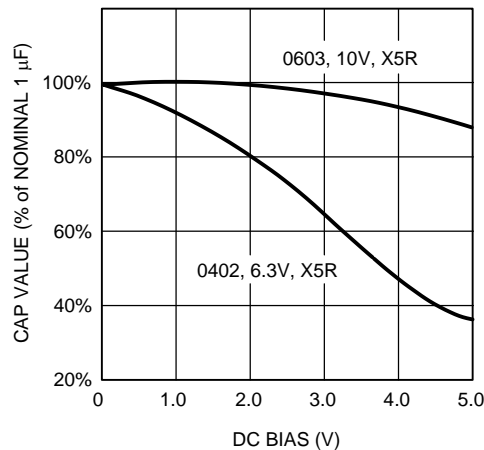

Figure 46. Graph Showing Typical Variation in Capacitance vs. DC Bias

As shown in the graph, increasing the DC Bias condition can result in the capacitance value that falls below the minimum value given in the recommended capacitor specifications table. Note that the graph shows the capacitance out of spec for the 0402 case size capacitor at higher bias voltages. It is therefore recommended that the capacitor manufacturers' specifications for the nominal value capacitor are consulted for all conditions, as some capacitor sizes (for example, 0402) may not be suitable in the actual application.

The ceramic capacitor's capacitance can vary with temperature. The capacitor type X7R, which operates over a temperature range of -55°C to 125°C , only varies the capacitance to within $\pm 15\%$. The capacitor type X5R has a similar tolerance over a reduced temperature range of -55°C to 85°C . Many large value ceramic capacitors, larger than $1\ \mu\text{F}$ are manufactured with Z5U or Y5V temperature characteristics. Their capacitance can drop by more than 50% as the temperature varies from 25°C to 85°C . Therefore, X7R is recommended over Z5U and Y5V in applications where the ambient temperature changes significantly above or below 25°C .

Tantalum capacitors are less desirable than ceramic for use as output capacitors because they are more expensive when comparing equivalent capacitance and voltage ratings in the $0.47\text{-}\mu\text{F}$ to $4.7\text{-}\mu\text{F}$ range.

Another important consideration is that tantalum capacitors have higher ESR values than equivalent size ceramics. This means that while it may be possible to find a tantalum capacitor with an ESR value within the stable range, it would have to be larger in capacitance (which means bigger and more costly) than a ceramic capacitor with the same ESR value. Note, also, that the ESR of a typical tantalum increases about 2:1 as the temperature goes from 25°C down to -40°C , so some guard band must be allowed.

9.2.2.3.4 Input Capacitor Selection for SW1 And SW2

A ceramic input capacitor of $10\ \mu\text{F}$, $6.3\ \text{V}$ is sufficient for the magnetic DC-DC converters. Place the input capacitor as close to the input of the device as possible. A large value may be used for improved input voltage filtering. The recommended capacitor types are X7R or X5R. Y5V type capacitors should not be used. DC bias characteristics of ceramic capacitors must be considered when selecting case sizes like 0805 and 0603. The input filter capacitor supplies current to the PFET switch of the DC-DC converter in the first half of each cycle and reduces voltage ripple imposed on the input power source. A ceramic capacitor's low ESR provides the best noise filtering of the input voltage spikes due to fast current transients. A capacitor with sufficient ripple current rating must be selected. The Input current ripple can be calculated as:

$$I_{\text{rms}} = I_{\text{outmax}} \sqrt{\frac{V_{\text{OUT}}}{V_{\text{IN}}} \left(1 + \frac{r^2}{12}\right)} \quad \text{where} \quad r = \frac{(V_{\text{in}} - V_{\text{out}}) \times V_{\text{out}}}{L \times f \times I_{\text{outmax}} \times V_{\text{in}}} \quad (8)$$

The worse case is when $V_{\text{IN}} = 2 V_{\text{OUT}}$.

9.2.2.3.5 Output Capacitor Selection for SW1, SW2

A 10- μ F, 6.3-V ceramic capacitor must be used on the output of the SW1 and SW2 magnetic DC-DC converters. The output capacitor must be mounted as close to the output of the device as possible. A large value may be used for improved input voltage filtering. The recommended capacitor types are X7R or X5R. Y5V type capacitors should not be used. DC bias characteristics of ceramic capacitors must be considered when selecting case sizes like 0805 and 0603. DC bias characteristics vary from manufacturer to manufacturer, and DC bias curves should be requested from them and analyzed as part of the capacitor selection process.

The output filter capacitor of the magnetic DC-DC converter smooths out current flow from the inductor to the load, helps maintain a steady output voltage during transient load changes and reduces output voltage ripple. These capacitors must be selected with sufficient capacitance and sufficiently low ESR to perform these functions.

The output voltage ripple is caused by the charging and discharging of the output capacitor and also due to its ESR and can be calculated as follows:

$$V_{pp-c} = \frac{I_{ripple}}{4 \times f \times C} \quad (9)$$

Voltage peak-to-peak ripple due to ESR can be expressed as follows:

$$V_{PP-ESR} = 2 \times I_{RIPPLE} \times R_{ESR} \quad (10)$$

Because the V_{PP-C} and V_{PP-ESR} are out of phase, the rms value can be used to get an approximate value of the peak-to-peak ripple:

$$V_{pp-rms} = \sqrt{V_{pp-c}^2 + V_{pp-esr}^2} \quad (11)$$

Note that the output voltage ripple is dependent on the inductor current ripple and the equivalent series resistance of the output capacitor (R_{ESR}). The R_{ESR} is frequency dependent as well as temperature dependent. Calculate the R_{ESR} with the applicable switching frequency and ambient temperature.

Table 9. Suggested Capacitor Values

CAPACITOR	MIN VALUE (μ F)	DESCRIPTION	RECOMMENDED TYPE
C_{LDO1}	0.47	LDO1 output capacitor	Ceramic, 6.3 V, X5R
C_{LDO2}	0.47	LDO2 output capacitor	Ceramic, 6.3 V, X5R
C_{SW1}	10	SW1 output capacitor	Ceramic, 6.3 V, X5R
C_{SW2}	10	SW2 output capacitor	Ceramic, 6.3 V, X5R

9.2.2.3.6 I²C Pullup Resistor

Both SDA and SCL pins must have pullup resistors connected to VINLDO12 or to the power supply of the I²C master. The values of the pullup resistors (typical approximately 1.8 k Ω) are determined by the capacitance of the bus. A resistor that is too large, combined with a given bus capacitance, results in a rise time that would violate the maximum rise time specification. A too-small resistor results in a contention with the pulldown transistor on either slave(s) or master.

9.2.2.4 Operation Without I²C Interface

Operation of the LP3907 without the I²C interface is possible if the system can operate with default values for the LDO and Buck regulators (see [Factory Programmable Options](#).) The I²C-less system must rely on the correct default output values of the LDO and Buck converters.

9.2.2.4.1 High V_{IN} High-Load Operation

Additional information is provided when the IC is operated at extremes of V_{IN} and regulator loads. These are described in terms of the junction temperature and, buck output ripple management.

9.2.2.4.2 Junction Temperature

The maximum junction temperature $T_{J-MAX-OP}$ of 125°C of the device package [Equation 12](#) through [Equation 17](#) demonstrate junction temperature determination, ambient temperature T_{A-MAX} , and total chip power must be controlled to keep T_J below this maximum:

$$T_{J-MAX-OP} = T_{A-MAX} + (R_{\theta JA}) [^{\circ}C/Watt] \times (P_{D-MAX}) [Watts] \tag{12}$$

Total device power dissipation P_{D-MAX} is the sum of the individual power dissipation of the four regulators plus a minor amount for chip overhead. Chip overhead is Bias, TSD, and LDO analog.

$$P_{D-MAX} = P_{LDO1} + P_{LDO2} + P_{BUCK1} + P_{BUCK2} + (0.0001A \times V_{IN}) [Watts]. \tag{13}$$

Power dissipation of LDO1:

$$P_{LDO1} = (V_{INLDO1} - V_{OUTLDO1}) \times I_{OUTLDO1} [V \times A] \tag{14}$$

Power dissipation of LDO2:

$$P_{LDO2} = (V_{INLDO2} - V_{OUTLDO2}) \times I_{OUTLDO2} [V \times A] \tag{15}$$

Power dissipation of Buck1:

$$P_{Buck1} = P_{IN} - P_{OUT} = V_{OUTBuck1} \times I_{OUTBuck1} \times (1 - \eta_1) / \eta_1 [V \times A]$$

where

- η_1 = efficiency of buck 1 (16)

Power dissipation of Buck2:

$$P_{Buck2} = P_{IN} - P_{OUT} = V_{OUTBuck2} \times I_{OUTBuck2} \times (1 - \eta_2) / \eta_2 [V \times A]$$

where

- η_2 = efficiency of Buck2

where

- η is the efficiency for the specific condition taken from efficiency graphs. (17)

9.2.3 Application Curves

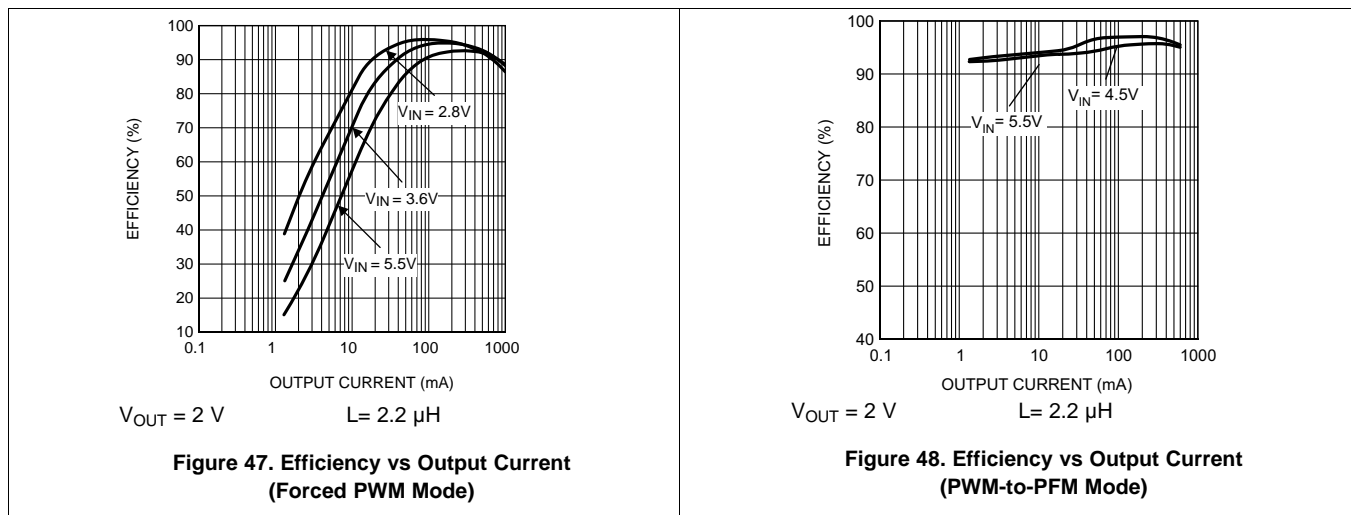

10 Power Supply Recommendations

If the EN_T is used to power up the device instead individual ENs , then VIN must be stable for approximately 8 ms minimum before EN_T be asserted high to ensure internal bias, reference, and the Flexible POR timing are stabilized. This initial EN_T delay is necessary only upon first time device power on for power sequencing function to operate properly.

10.1 Analog Power Signal Routing

All power inputs must be tied to the main VDD source (for example, battery), unless the user wishes to power it from another source. (that is, external LDO output).

The analog VDD inputs power the internal bias and error amplifiers, so they must be tied to the main VDD. The analog VDD inputs must have an input voltage between 2.8 V and 5.5 V, as specified in the [Recommended Operating Conditions \(Bucks\)](#) table earlier in the data sheet.

The other VINs (VINLDO1, VINLDO2) can have inputs lower than 2.8 V, as long as the input it higher than the programmed output (0.3 V).

The analog and digital grounds must be tied together outside of the chip to reduce noise coupling.

11 Layout

11.1 DSBGA Layout Guidelines

PC board layout is an important part of DC-DC converter design. Poor board layout can disrupt the performance of a DC-DC converter and surrounding circuitry by contributing to EMI, ground bounce, and resistive voltage loss in the traces. These can send erroneous signals to the DC-DC converter device, resulting in poor regulation or instability.

Good layout for the LP3907 device bucks can be implemented by following a few simple design rules below. Refer to [Figure 49](#) for top-layer board buck layout.

1. *Place the LP3907 bucks, inductor, and filter capacitors close together and make the traces short.* The traces between these components carry relatively high switching currents and act as antennas. Following this rule reduces radiated noise. Special care must be given to place the input filter capacitor very close to the VIN and GND pin.
2. *Arrange the components so that the switching current loops curl in the same direction.* During the first half of each cycle, current flows from the input filter capacitor through the LP3907 bucks and inductor to the output filter capacitor and back through ground, forming a current loop. In the second half of each cycle, current is pulled up from ground through the LP3907 bucks by the inductor to the output filter capacitor and then back through ground forming a second current loop. Routing these loops so the current curls in the same direction prevents magnetic field reversal between the two half-cycles and reduces radiated noise.
3. *Connect the ground pins of the LP3907 bucks and filter capacitors together using generous component-side copper fill as a pseudo-ground plane.* Then, connect this to the ground-plane (if one is used) with several vias. This reduces ground-plane noise by preventing the switching currents from circulating through the ground plane. It also reduces ground bounce at the LP3907 bucks by giving it a low-impedance ground connection.
4. *Use wide traces between the power components and for power connections to the DC-DC converter circuit.* This reduces voltage errors caused by resistive losses across the traces.
5. *Route noise sensitive traces, such as the voltage feedback path, away from noisy traces between the power components.* The voltage feedback trace must remain close to the circuit of the LP3907 buck and must be direct but must be routed opposite to noisy components. This reduces EMI radiated onto the DC-DC converter's own voltage feedback trace. A good approach is to route the feedback trace on another layer and to have a ground plane between the top layer and layer on which the feedback trace is routed. In the same manner for the adjustable part it is desired to have the feedback dividers on the bottom layer.
6. *Place noise sensitive circuitry, such as radio IF blocks, away from the DC-DC converter, CMOS digital blocks and other noisy circuitry.* Interference with noise-sensitive circuitry in the system can be reduced through distance.

For more detailed layout specifications and information, refer to [AN-1112 DSBGA Wafer Level Chip Scale Package](#).

11.2 Layout Example

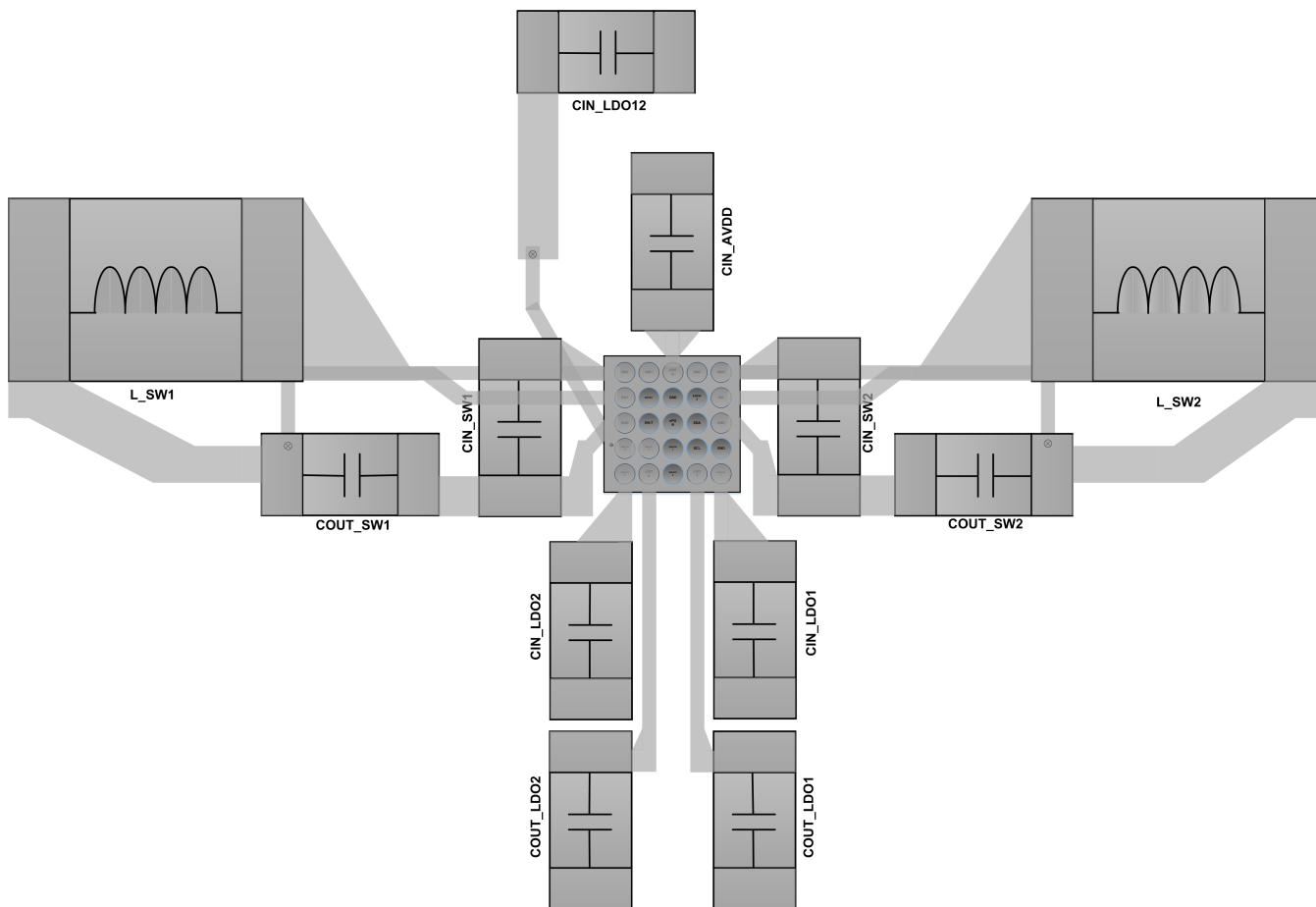

Figure 49. LP3907 DSBGA Layout Example

11.3 Thermal Considerations of WQFN Package

The LP3907 is a monolithic device with integrated power FETs. For that reason, it is important to pay special attention to the thermal impedance of the WQFN package and to the PCB layout rules in order to maximize power dissipation of the WQFN package.

The WQFN package is designed for enhanced thermal performance and features an exposed die attach pad at the bottom center of the package that creates a direct path to the PCB for maximum power dissipation. Compared to the traditional leaded packages where the die attach pad is embedded inside the molding compound, the WQFN reduces one layer in the thermal path.

The thermal advantage of the WQFN package is fully realized only when the exposed die attach pad is soldered down to a thermal land on the PCB board with thermal vias planted underneath the thermal land. Based on thermal analysis of the WQFN package, the junction-to-ambient thermal resistance ($R_{\theta JA}$) can be improved by a factor of two when the die attach pad of the WQFN package is soldered directly onto the PCB with thermal land and thermal vias, as opposed to an alternative with no direct soldering to a thermal land. Typical pitch and outer diameter for thermal vias are 1.27 mm and 0.33 mm, respectively. Typical copper via barrel plating is 1 oz, although thicker copper may be used to further improve thermal performance. The LP3907 die attach pad is connected to the substrate of the device, and therefore, the thermal land and vias on the PCB board must be connected to ground (GND pin).

For more information on board layout techniques, refer to [AN-1187 Leadless Lead Frame Package \(LLP\)](#) on <http://www.ti.com>. This application note also discusses package handling, solder stencil, and the assembly process.

12 Device and Documentation Support

12.1 Device Support

12.1.1 Development Support

12.1.1.1 Custom Design With WEBENCH® Tools

Click [here](#) to create a custom design using the LP3907 device with the WEBENCH® Power Designer.

1. Start by entering the input voltage (V_{IN}), output voltage (V_{OUT}), and output current (I_{OUT}) requirements.
2. Optimize the design for key parameters such as efficiency, footprint, and cost using the optimizer dial.
3. Compare the generated design with other possible solutions from Texas Instruments.

The WEBENCH Power Designer provides a customized schematic along with a list of materials with real-time pricing and component availability.

In most cases, these actions are available:

- Run electrical simulations to see important waveforms and circuit performance
- Run thermal simulations to understand board thermal performance
- Export customized schematic and layout into popular CAD formats
- Print PDF reports for the design, and share the design with colleagues

Get more information about WEBENCH tools at www.ti.com/WEBENCH.

12.2 Documentation Support

12.2.1 Related Documentation

For related documentation, see the following:

- [AN-1112 DSBGA Wafer Level Chip Scale Package](#)
- [AN-1187 Leadless Lead Frame Package \(LLP\)](#)

12.3 Trademarks

E2E is a trademark of Texas Instruments.

WEBENCH is a registered trademark of Texas Instruments.

All other trademarks are the property of their respective owners.

12.4 Receiving Notification of Documentation Updates

To receive notification of documentation updates, navigate to the device product folder on ti.com. In the upper right corner, click on *Alert me* to register and receive a weekly digest of any product information that has changed. For change details, review the revision history included in any revised document.

12.5 Community Resources

The following links connect to TI community resources. Linked contents are provided "AS IS" by the respective contributors. They do not constitute TI specifications and do not necessarily reflect TI's views; see TI's [Terms of Use](#).

TI E2E™ Online Community *TI's Engineer-to-Engineer (E2E) Community*. Created to foster collaboration among engineers. At e2e.ti.com, you can ask questions, share knowledge, explore ideas and help solve problems with fellow engineers.

Design Support *TI's Design Support* Quickly find helpful E2E forums along with design support tools and contact information for technical support.

12.6 Electrostatic Discharge Caution



These devices have limited built-in ESD protection. The leads should be shorted together or the device placed in conductive foam during storage or handling to prevent electrostatic damage to the MOS gates.

12.7 Glossary

[SLYZ022](#) — *TI Glossary*.

This glossary lists and explains terms, acronyms, and definitions.

13 Mechanical, Packaging, and Orderable Information

The following pages include mechanical, packaging, and orderable information. This information is the most current data available for the designated devices. This data is subject to change without notice and revision of this document. For browser-based versions of this data sheet, refer to the left-hand navigation.

PACKAGING INFORMATION

Orderable Device	Status (1)	Package Type	Package Drawing	Pins	Package Qty	Eco Plan (2)	Lead/Ball Finish (6)	MSL Peak Temp (3)	Op Temp (°C)	Device Marking (4/5)	Samples
LP3907SQ-BJXQX/NOPB	ACTIVE	WQFN	RTW	24	1000	Green (RoHS & no Sb/Br)	CU SN	Level-1-260C-UNLIM	-40 to 85	07BJXQX	Samples
LP3907SQ-JXQX/NOPB	ACTIVE	WQFN	RTW	24	1000	Green (RoHS & no Sb/Br)	CU SN	Level-1-260C-UNLIM	-40 to 85	07-JXQX	Samples
LP3907SQ-PFX6W/NOPB	ACTIVE	WQFN	RTW	24	1000	Green (RoHS & no Sb/Br)	CU SN	Level-1-260C-UNLIM	-40 to 85	7PFX6W	Samples
LP3907SQ-PJXIX/NOPB	ACTIVE	WQFN	RTW	24	1000	Green (RoHS & no Sb/Br)	CU SN	Level-1-260C-UNLIM	-40 to 85	07PJXIX	Samples
LP3907SQ-TJXIP/NOPB	ACTIVE	WQFN	RTW	24	1000	Green (RoHS & no Sb/Br)	CU SN	Level-1-260C-UNLIM	-40 to 85	07TJXIP	Samples
LP3907TL-JJ11/NOPB	ACTIVE	DSBGA	YZR	25	250	Green (RoHS & no Sb/Br)	SNAGCU	Level-1-260C-UNLIM	-40 to 85	V013	Samples
LP3907TL-JJCP/NOPB	ACTIVE	DSBGA	YZR	25	250	Green (RoHS & no Sb/Br)	SNAGCU	Level-1-260C-UNLIM	-40 to 85	V016	Samples
LP3907TL-JSXS/NOPB	ACTIVE	DSBGA	YZR	25	250	Green (RoHS & no Sb/Br)	SNAGCU	Level-1-260C-UNLIM	-40 to 85	V012	Samples
LP3907TL-PLNTO/NOPB	ACTIVE	DSBGA	YZR	25	250	Green (RoHS & no Sb/Br)	SNAGCU	Level-1-260C-UNLIM	-40 to 85	V027	Samples
LP3907TLX-JJ11/NOPB	ACTIVE	DSBGA	YZR	25	3000	Green (RoHS & no Sb/Br)	SNAGCU	Level-1-260C-UNLIM	-40 to 85	V013	Samples

(1) The marketing status values are defined as follows:

ACTIVE: Product device recommended for new designs.

LIFEBUY: TI has announced that the device will be discontinued, and a lifetime-buy period is in effect.

NRND: Not recommended for new designs. Device is in production to support existing customers, but TI does not recommend using this part in a new design.

PREVIEW: Device has been announced but is not in production. Samples may or may not be available.

OBSOLETE: TI has discontinued the production of the device.

(2) **RoHS:** TI defines "RoHS" to mean semiconductor products that are compliant with the current EU RoHS requirements for all 10 RoHS substances, including the requirement that RoHS substance do not exceed 0.1% by weight in homogeneous materials. Where designed to be soldered at high temperatures, "RoHS" products are suitable for use in specified lead-free processes. TI may reference these types of products as "Pb-Free".

RoHS Exempt: TI defines "RoHS Exempt" to mean products that contain lead but are compliant with EU RoHS pursuant to a specific EU RoHS exemption.

Green: TI defines "Green" to mean the content of Chlorine (Cl) and Bromine (Br) based flame retardants meet JS709B low halogen requirements of <=1000ppm threshold. Antimony trioxide based flame retardants must also meet the <=1000ppm threshold requirement.

(3) MSL, Peak Temp. - The Moisture Sensitivity Level rating according to the JEDEC industry standard classifications, and peak solder temperature.

(4) There may be additional marking, which relates to the logo, the lot trace code information, or the environmental category on the device.

(5) Multiple Device Markings will be inside parentheses. Only one Device Marking contained in parentheses and separated by a "~" will appear on a device. If a line is indented then it is a continuation of the previous line and the two combined represent the entire Device Marking for that device.

(6) Lead/Ball Finish - Orderable Devices may have multiple material finish options. Finish options are separated by a vertical ruled line. Lead/Ball Finish values may wrap to two lines if the finish value exceeds the maximum column width.

Important Information and Disclaimer:The information provided on this page represents TI's knowledge and belief as of the date that it is provided. TI bases its knowledge and belief on information provided by third parties, and makes no representation or warranty as to the accuracy of such information. Efforts are underway to better integrate information from third parties. TI has taken and continues to take reasonable steps to provide representative and accurate information but may not have conducted destructive testing or chemical analysis on incoming materials and chemicals. TI and TI suppliers consider certain information to be proprietary, and thus CAS numbers and other limited information may not be available for release.

In no event shall TI's liability arising out of such information exceed the total purchase price of the TI part(s) at issue in this document sold by TI to Customer on an annual basis.

OTHER QUALIFIED VERSIONS OF LP3907 :

- Automotive: [LP3907-Q1](#)

NOTE: Qualified Version Definitions:

- Automotive - Q100 devices qualified for high-reliability automotive applications targeting zero defects

TAPE AND REEL INFORMATION

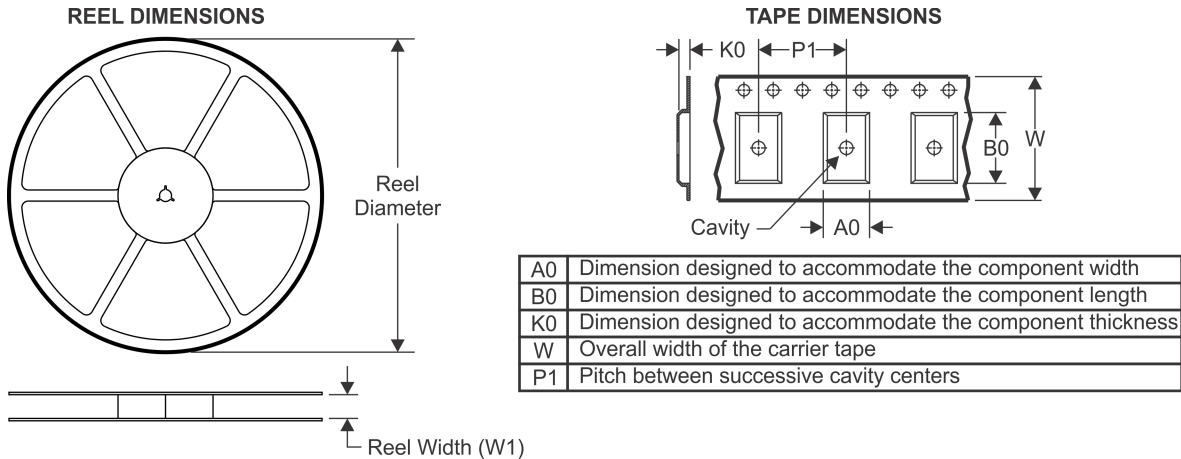

QUADRANT ASSIGNMENTS FOR PIN 1 ORIENTATION IN TAPE

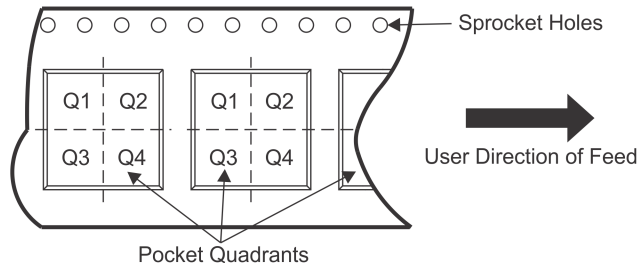

*All dimensions are nominal

Device	Package Type	Package Drawing	Pins	SPQ	Reel Diameter (mm)	Reel Width W1 (mm)	A0 (mm)	B0 (mm)	K0 (mm)	P1 (mm)	W (mm)	Pin1 Quadrant
LP3907SQ-BJXQX/NOPB	WQFN	RTW	24	1000	178.0	12.4	4.3	4.3	1.3	8.0	12.0	Q1
LP3907SQ-JXQX/NOPB	WQFN	RTW	24	1000	178.0	12.4	4.3	4.3	1.3	8.0	12.0	Q1
LP3907SQ-PFX6W/NOPB	WQFN	RTW	24	1000	178.0	12.4	4.3	4.3	1.3	8.0	12.0	Q1
LP3907SQ-PJXIX/NOPB	WQFN	RTW	24	1000	178.0	12.4	4.3	4.3	1.3	8.0	12.0	Q1
LP3907SQ-TJXIP/NOPB	WQFN	RTW	24	1000	178.0	12.4	4.3	4.3	1.3	8.0	12.0	Q1
LP3907TL-JJ11/NOPB	DSBGA	YZR	25	250	178.0	8.4	2.69	2.69	0.76	4.0	8.0	Q1
LP3907TL-JJCP/NOPB	DSBGA	YZR	25	250	178.0	8.4	2.69	2.69	0.76	4.0	8.0	Q1
LP3907TL-JSXS/NOPB	DSBGA	YZR	25	250	178.0	8.4	2.69	2.69	0.76	4.0	8.0	Q1
LP3907TL-PLNTO/NOPB	DSBGA	YZR	25	250	178.0	8.4	2.69	2.69	0.76	4.0	8.0	Q1
LP3907TLX-JJ11/NOPB	DSBGA	YZR	25	3000	178.0	8.4	2.69	2.69	0.76	4.0	8.0	Q1

TAPE AND REEL BOX DIMENSIONS

*All dimensions are nominal

Device	Package Type	Package Drawing	Pins	SPQ	Length (mm)	Width (mm)	Height (mm)
LP3907SQ-BJXQX/NOPB	WQFN	RTW	24	1000	210.0	185.0	35.0
LP3907SQ-JXQX/NOPB	WQFN	RTW	24	1000	210.0	185.0	35.0
LP3907SQ-PFX6W/NOPB	WQFN	RTW	24	1000	210.0	185.0	35.0
LP3907SQ-PJXIX/NOPB	WQFN	RTW	24	1000	210.0	185.0	35.0
LP3907SQ-TJXIP/NOPB	WQFN	RTW	24	1000	210.0	185.0	35.0
LP3907TL-JJ11/NOPB	DSBGA	YZR	25	250	210.0	185.0	35.0
LP3907TL-JJCP/NOPB	DSBGA	YZR	25	250	210.0	185.0	35.0
LP3907TL-JSXS/NOPB	DSBGA	YZR	25	250	210.0	185.0	35.0
LP3907TL-PLNTO/NOPB	DSBGA	YZR	25	250	210.0	185.0	35.0
LP3907TLX-JJ11/NOPB	DSBGA	YZR	25	3000	210.0	185.0	35.0

YZR0025

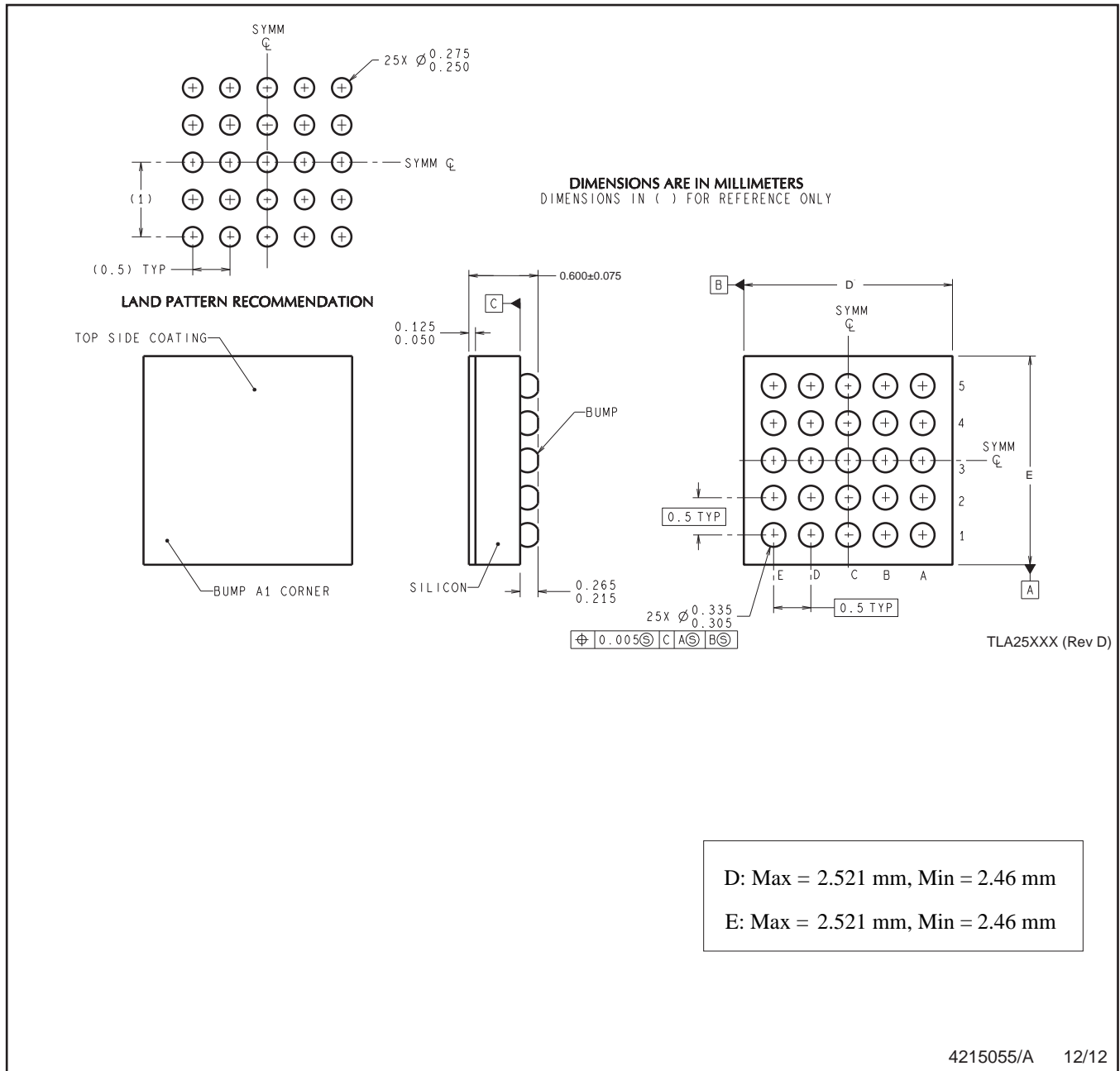

4215055/A 12/12

NOTES: A. All linear dimensions are in millimeters. Dimensioning and tolerancing per ASME Y14.5M-1994.
B. This drawing is subject to change without notice.

EXAMPLE BOARD LAYOUT

RTW0024A

WQFN - 0.8 mm max height

PLASTIC QUAD FLATPACK - NO LEAD

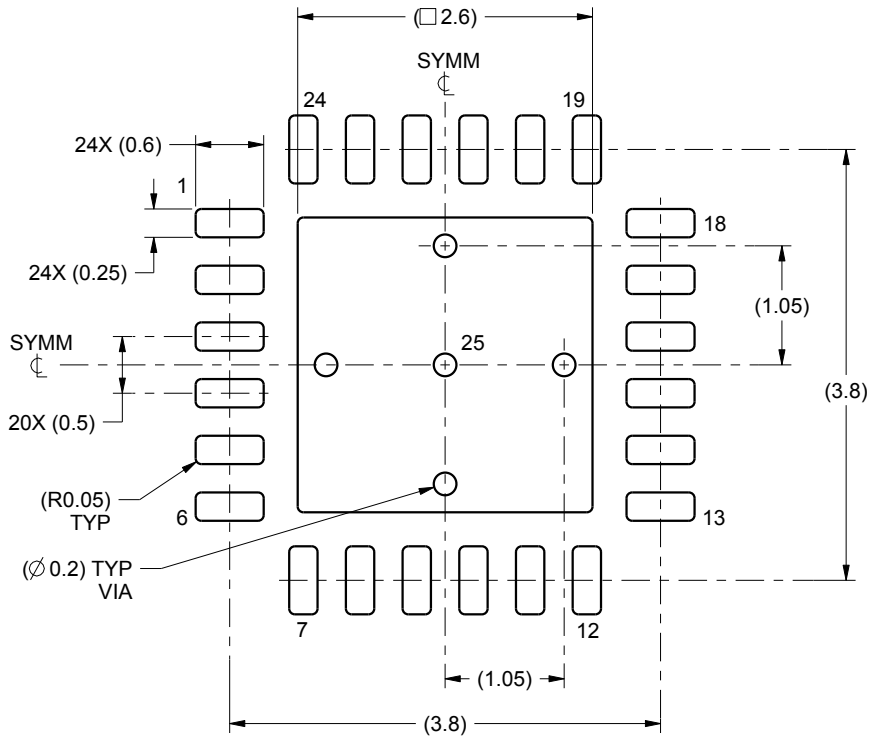

LAND PATTERN EXAMPLE
SCALE:15X

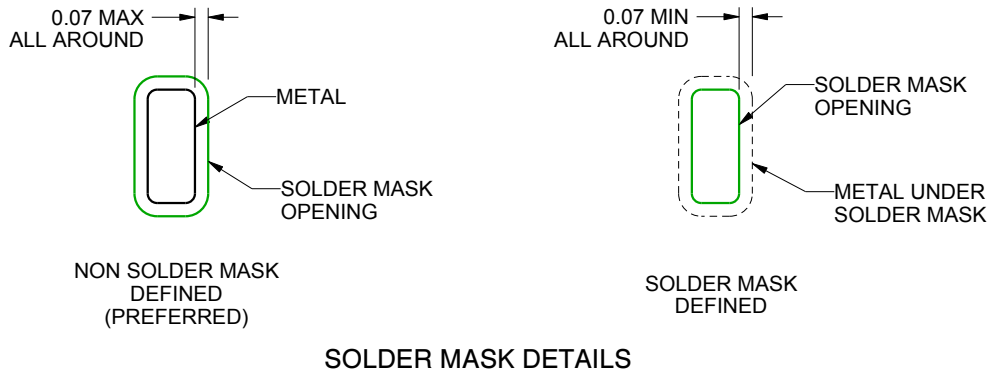

SOLDER MASK DETAILS

4222815/A 03/2016

NOTES: (continued)

4. This package is designed to be soldered to a thermal pad on the board. For more information, see Texas Instruments literature number SLUA271 (www.ti.com/lit/sluea271).

EXAMPLE STENCIL DESIGN

RTW0024A

WQFN - 0.8 mm max height

PLASTIC QUAD FLATPACK - NO LEAD

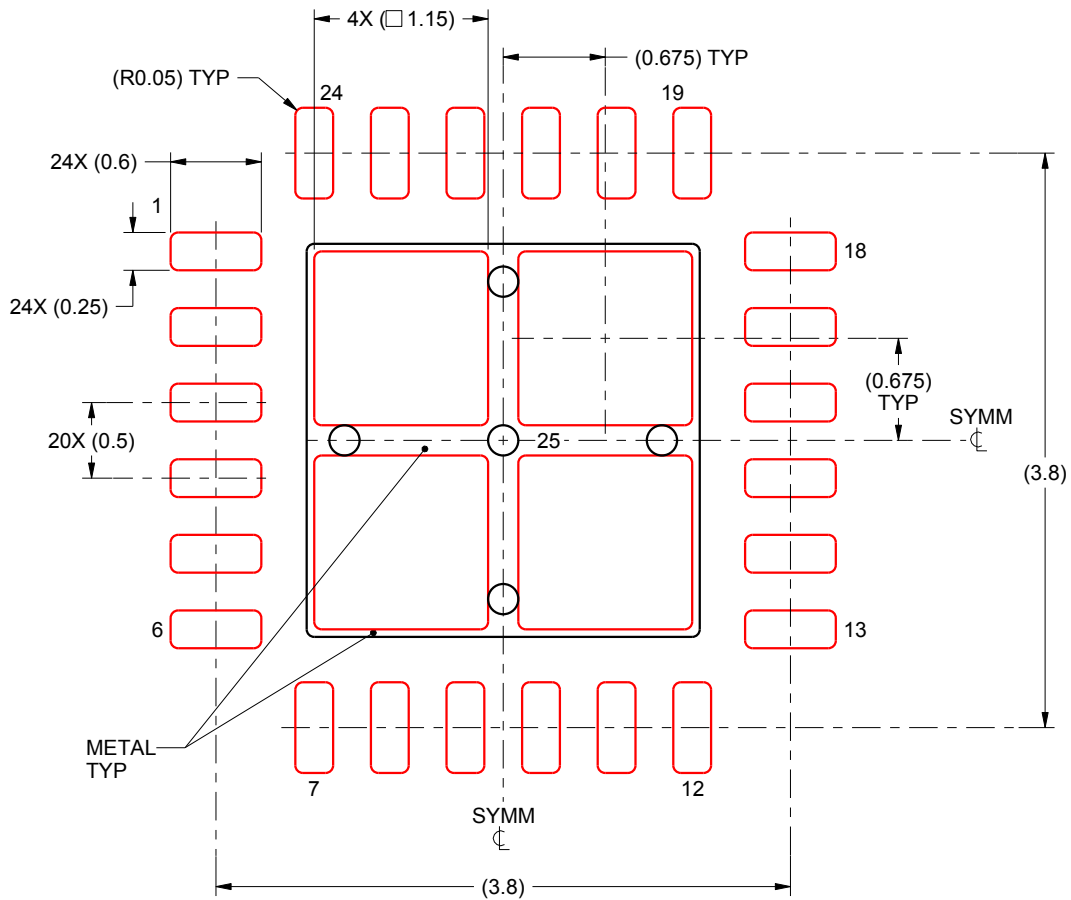

SOLDER PASTE EXAMPLE
BASED ON 0.125 mm THICK STENCIL

EXPOSED PAD 25:
78% PRINTED SOLDER COVERAGE BY AREA UNDER PACKAGE
SCALE:20X

4222815/A 03/2016

NOTES: (continued)

5. Laser cutting apertures with trapezoidal walls and rounded corners may offer better paste release. IPC-7525 may have alternate design recommendations.

IMPORTANT NOTICE AND DISCLAIMER

TI PROVIDES TECHNICAL AND RELIABILITY DATA (INCLUDING DATASHEETS), DESIGN RESOURCES (INCLUDING REFERENCE DESIGNS), APPLICATION OR OTHER DESIGN ADVICE, WEB TOOLS, SAFETY INFORMATION, AND OTHER RESOURCES "AS IS" AND WITH ALL FAULTS, AND DISCLAIMS ALL WARRANTIES, EXPRESS AND IMPLIED, INCLUDING WITHOUT LIMITATION ANY IMPLIED WARRANTIES OF MERCHANTABILITY, FITNESS FOR A PARTICULAR PURPOSE OR NON-INFRINGEMENT OF THIRD PARTY INTELLECTUAL PROPERTY RIGHTS.



These resources are intended for skilled developers designing with TI products. You are solely responsible for (1) selecting the appropriate TI products for your application, (2) designing, validating and testing your application, and (3) ensuring your application meets applicable standards, and any other safety, security, or other requirements. These resources are subject to change without notice. TI grants you permission to use these resources only for development of an application that uses the TI products described in the resource. Other reproduction and display of these resources is prohibited. No license is granted to any other TI intellectual property right or to any third party intellectual property right. TI disclaims responsibility for, and you will fully indemnify TI and its representatives against, any claims, damages, costs, losses, and liabilities arising out of your use of these resources.

TI's products are provided subject to TI's Terms of Sale (www.ti.com/legal/termsofsale.html) or other applicable terms available either on ti.com or provided in conjunction with such TI products. TI's provision of these resources does not expand or otherwise alter TI's applicable warranties or warranty disclaimers for TI products.

Mailing Address: Texas Instruments, Post Office Box 655303, Dallas, Texas 75265
Copyright © 2019, Texas Instruments Incorporated

Looking for pricing, stock, or lifecycle information?

Click below to explore more details on WIN SOURCE:

-  [View LP3907SQ-BJX6X/NOPB on WIN SOURCE](#)
-  [Texas Instruments](#) Information

Optimize Your Supply Chain with WIN SOURCE Solutions

-  Global Sourcing Solution
-  Obsolete Management
-  Cost Control Management
-  Shortage Management
-  Alternative Solution
-  Excess Inventory Management