



**THE DATASHEET OF
2SB1709TL**



General purpose amplification(−12V, −1.5A)

2SB1709

●Application

Low frequency amplifier
Driver

●Features

- 1) A collector current is large.
- 2) Collector saturation voltage is low.

$$V_{CE(sat)} \leq -200\text{mV}$$

$$\text{at } I_C = -500\text{mA} / I_B = -25\text{mA}$$

●External dimensions (Unit : mm)

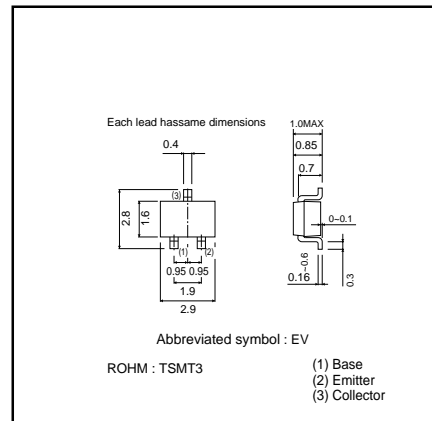

●Absolute maximum ratings (Ta=25°C)

Parameter	Symbol	Limits	Unit
Collector-base voltage	V_{CBO}	-15	V
Collector-emitter voltage	V_{CEO}	-12	V
Emitter-base voltage	V_{EBO}	-6	V
Collector current	I_C	-1.5	A
	I_{CP}	-3	A*1
Power dissipation	P_C	500	mW*2
Junction temperature	T_j	150	°C
Range of storage temperature	T_{stg}	-55~+150	°C

*1Single pulse, $P_W=1\text{ms}$

*2Each Terminal Mounted on a Recommended Land

●Packaging specifications

Type	Package	Taping
	Code	TL
	Basic ordering unit (pieces)	3000
2SB1709		○

●Electrical characteristics (Ta=25°C)

Parameter	Symbol	Min.	Typ.	Max.	Unit	Conditions
Collector-base breakdown voltage	BV_{CBO}	-15	-	-	V	$I_C=-10\mu\text{A}$
Collector-emitter breakdown voltage	BV_{CEO}	-12	-	-	V	$I_C=-1\text{mA}$
Emitter-base breakdown voltage	BV_{EBO}	-6	-	-	V	$I_E=-10\mu\text{A}$
Collector cutoff current	I_{CBO}	-	-	-100	nA	$V_{CB}=-15\text{V}$
Emitter cutoff current	I_{EBO}	-	-	-100	nA	$V_{EB}=-6\text{V}$
Collector-emitter saturation voltage	$V_{CE(sat)}$	-	-85	-200	mV	$I_C=-500\text{mA}, I_B=-25\text{mA}$
DC current gain	h_{FE}	270	-	680	-	$V_{CE}=-2\text{V}, I_C=-200\text{mA}^*$
Transition frequency	f_T	-	400	-	MHz	$V_{CE}=-2\text{V}, I_E=200\text{mA}, f=100\text{MHz}^*$
Corrector output capacitance	C_{ob}	-	12	-	pF	$V_{CB}=-10\text{V}, I_E=0\text{A}, f=1\text{MHz}$

* Pulsed

Transistors

●Electrical characteristic curves

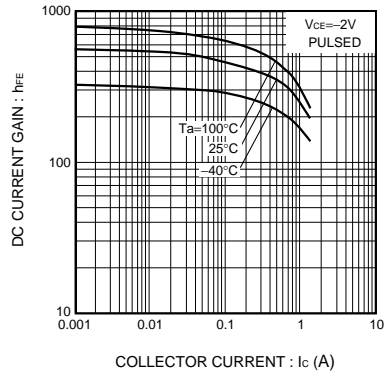

Fig.1 DC current gain vs. collector current

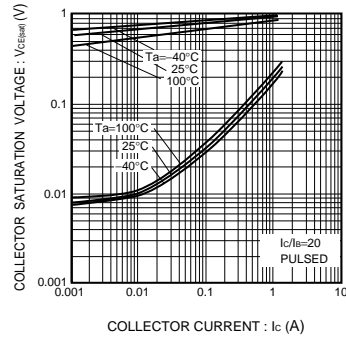

Fig.2 Collector-emitter saturation voltage vs. collector current

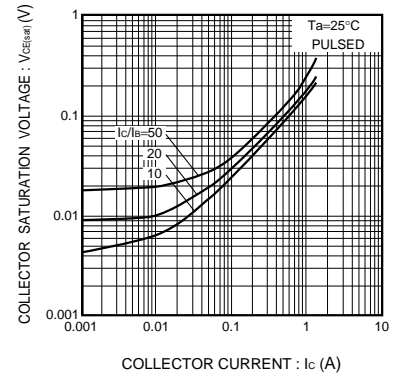

Fig.3 Base-emitter saturation voltage vs. collector current

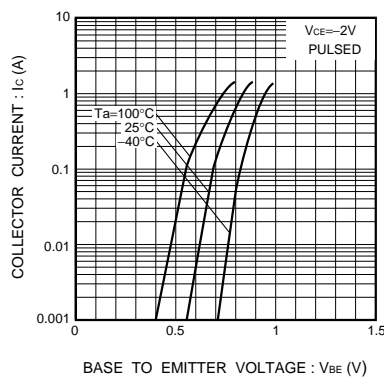

Fig.4 Collector-emitter saturation voltage vs. collector current

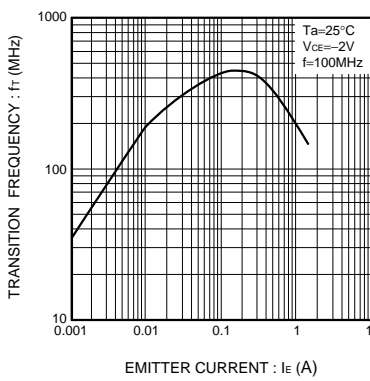

Fig.5 Grounded emitter propagation characteristics

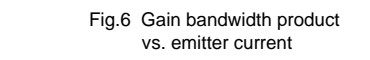

Fig.6 Gain bandwidth product vs. emitter current

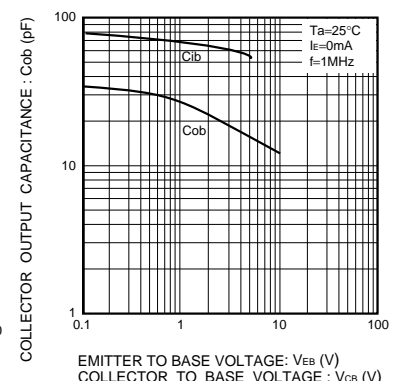



Fig.7 Collector output capacitance vs. collector-base voltage
Emitter input capacitance vs. emitter-base voltage

Looking for pricing, stock, or lifecycle information?

Click below to explore more details on WIN SOURCE:

-  [View 2SB1709TL on WIN SOURCE](#)
-  [Rohm Semiconductor](#) Information

Optimize Your Supply Chain with WIN SOURCE Solutions

-  Global Sourcing Solution
-  Obsolete Management
-  Cost Control Management
-  Shortage Management
-  Alternative Solution
-  Excess Inventory Management