



**THE DATASHEET OF  
LP3990SD-0.8/NOPB**



# LP3990

## 150mA Linear Voltage Regulator for Digital Applications

### General Description

The LP3990 regulator is designed to meet the requirements of portable, battery-powered systems providing an accurate output voltage, low noise, and low quiescent current. The LP3990 will provide a 0.8V output from the low input voltage of 2V at up to 150mA load current. When switched into shut-down mode via a logic signal at the enable pin, the power consumption is reduced to virtually zero.

The LP3990 is designed to be stable with space saving ceramic capacitors as small as 1.0 $\mu$ F.

Performance is specified for a -40°C to 125°C junction temperature range.

For output voltages other than 0.8V, 1.2, 1.35V, 1.5V, 1.8V, 2.5V, 2.8V, or 3.3V please contact your local NSC sales office.

### Features

- 1% Voltage Accuracy at Room Temperature
- Stable with Ceramic Capacitor
- Logic Controlled Enable
- No Noise Bypass Capacitor Required
- Thermal-Overload and Short-Circuit Protection

### Key Specifications

■ Input Voltage Range	2.0 to 6.0V
■ Output Voltage Range	0.8 to 3.3V
■ Output Current	150mA
■ Output Stable - Capacitors	1.0 $\mu$ F
■ Virtually Zero $I_Q$ (Disabled)	<10nA
■ Very Low $I_Q$ (Enabled)	43 $\mu$ A
■ Low Output Noise	150 $\mu$ V <sub>RMS</sub>
■ PSRR	55dB at 1kHz
■ Fast Start Up	105 $\mu$ s

### Package

All available in Lead Free option.

4 Pin micro SMD

1 mm x 1.3 mm

6 pin LLP (SOT23 footprint)

SOT23 - 5

For other package options contact your NSC sales office.

### Applications

- Cellular Handsets
- Hand-Held Information Appliances

### Typical Application Circuit

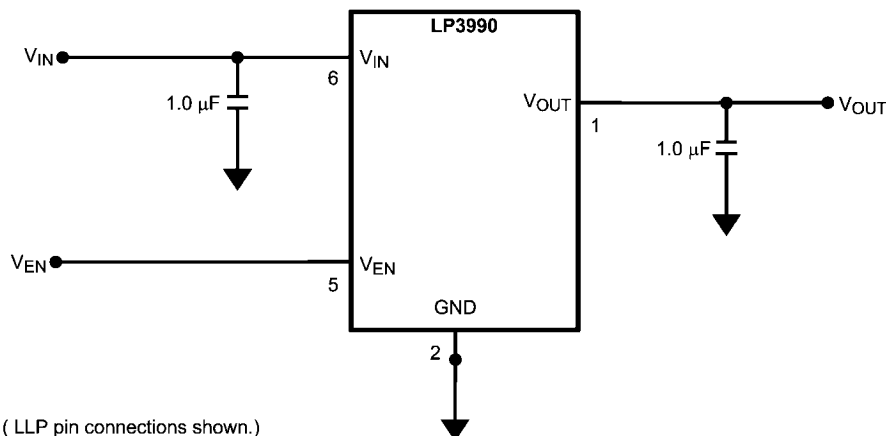

20076801

# Pin Descriptions

## Packages

Pin No			Symbol	Name and Function
LLP	micro SMD	SOT23-5		
5	A2	3	$V_{EN}$	Enable Input; Enables the Regulator when $\geq 0.95V$ . Disables the Regulator when $\leq 0.4V$ . Enable Input has $1M\Omega$ pulldown resistor to GND.
2	A1	2	GND	Common Ground. Connect to Pad.
1	B1	5	$V_{OUT}$	Voltage output. A $1.0\mu F$ Low ESR Capacitor should be connected to this Pin. Connect this output to the load circuit.
6	B2	1	$V_{IN}$	Voltage Supply Input. A $1.0\mu F$ capacitor should be connected at this input.
3		4	N/C	No Connection. Do not connect to any other pin.
4			N/C	No Connection. Do not connect to any other pin.
Pad			GND	Common Ground. Connect to Pin 2.

## Connection Diagrams

### Micro SMD, 4 Bump Package

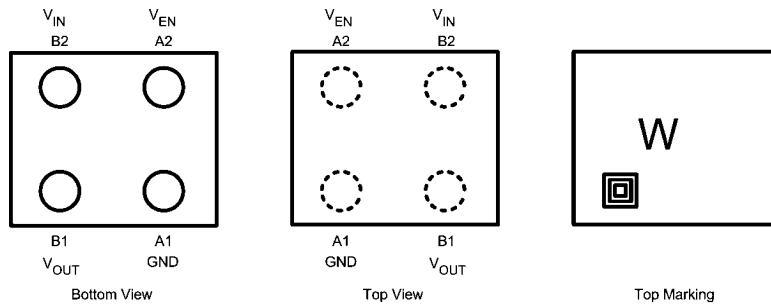

See NS package number TLA04

20076803

### LLP-6 Package

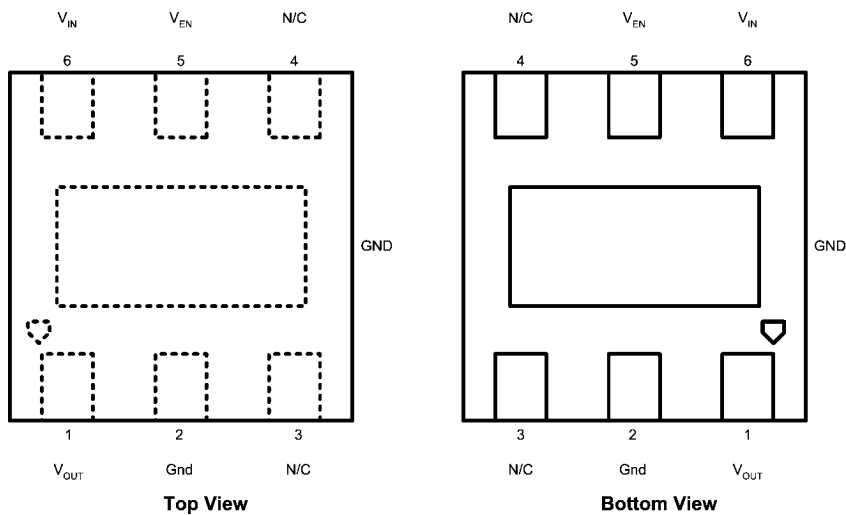

See NS package number SDE06A

20076806

**SOT23 - 5 Package (MF)**

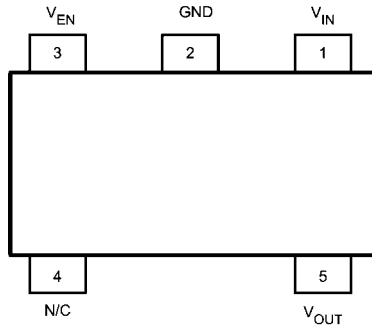

See NS package number MF05A<sup>20076808</sup>

## Ordering Information

### For micro SMD Package

Output Voltage (V)	Grade	LP3990 Supplied as 250 Units, Tape and Reel	LP3990 Supplied as 3000 Units, Tape and Reel	Package Marking
0.8	STD	LP3990TL-0.8	LP3990TLX-0.8	
1.2	STD	LP3990TL-1.2	LP3990TLX-1.2	
1.35	STD	LP3990TL-1.35	LP3990TLX-1.35	
1.5	STD	LP3990TL-1.5	LP3990TLX-1.5	
1.8	STD	LP3990TL-1.8	LP3990TLX-1.8	
2.5	STD	LP3990TL-2.5	LP3990TLX-2.5	
2.8	STD	LP3990TL-2.8	LP3990TLX-2.8	

### For LLP-6 Package

Output Voltage (V)	Grade	LP3990 Supplied as 1000 Units, Tape and Reel	LP3990 Supplied as 3000 Units, Tape and Reel	Package Marking
0.8	STD	LP3990SD-0.8	LP3990SDX-0.8	L085B
1.2	STD	LP3990SD-1.2	LP3990SDX-1.2	L086B
1.35	STD	LP3990SD-1.35	LP3990SDX-1.35	L150B
1.5	STD	LP3990SD-1.5	LP3990SDX-1.5	L087B
1.8	STD	LP3990SD-1.8	LP3990SDX-1.8	L088B
2.5	STD	LP3990SD-2.5	LP3990SDX-2.5	L090B
2.8	STD	LP3990SD-2.8	LP3990SDX-2.8	L091B

### For SOT23 - 5 Package

Output Voltage (V)	Grade	LP3990 Supplied as 1000 Units, Tape and Reel	LP3990 Supplied as 3000 Units, Tape and Reel	Package Marking
1.2	STD	LP3990MF-1.2	LP3990MFX-1.2	SCDB
1.5	STD	LP3990MF-1.5	LP3990MFX-1.5	SCEB
1.8	STD	LP3990MF-1.8	LP3990MFX-1.8	SCFB
2.5	STD	LP3990MF-2.5	LP3990MFX-2.5	SCJB
2.8	STD	LP3990MF-2.8	LP3990MFX-2.8	SCKB
3.3	STD	LP3990MF-3.3	LP3990MFX-3.3	SCLB

## Absolute Maximum Ratings

(Notes 1, 2)

If Military/Aerospace specified devices are required, please contact the National Semiconductor Sales Office/Distributors for availability and specifications.

Input Voltage	-0.3 to 6.5V
Output Voltage	-0.3 to ( $V_{IN} + 0.3V$ ) with 6.5V (max)
Enable Input Voltage	-0.3 to ( $V_{IN} + 0.3V$ ) with 6.5V (max)
Junction Temperature	150°C
Lead/Pad Temp. (Note 3)	
LLP/SOT23	235°C
micro SMD	260°C
Storage Temperature	-65 to 150°C
Continuous Power Dissipation Internally Limited(Note 4)	
ESD (Note 5)	

Human Body Model

2KV

Machine Model

200V

## Operating Ratings (Note 1)

Input Voltage	2V to 6V
Enable Input Voltage	0 to ( $V_{IN} + 0.3V$ ) with 6.0V (max)
Junction Temperature	-40°C to 125°C
Ambient Temperature $T_A$ Range (Note 6)	-40°C to 85°C

## Thermal Properties (Note 1)

Junction To Ambient Thermal Resistance(Note 8)	
$\theta_{JA}$ (LLP-6)	88°C/W
$\theta_{JA}$ (microSMD)	220°C/W
$\theta_{JA}$ SOT23-5	220°C/W

## Electrical Characteristics

Unless otherwise noted,  $V_{EN} = 950mV$ ,  $V_{IN} = V_{OUT} + 1.0V$ , or 2.0V, whichever is higher.  $C_{IN} = 1 \mu F$ ,  $I_{OUT} = 1 mA$ ,  $C_{OUT} = 0.47 \mu F$ .

Typical values and limits appearing in normal type apply for  $T_J = 27^\circ C$ . Limits appearing in **boldface** type apply over the full junction temperature range for operation, -40 to +125°C. (Note 13)

Symbol	Parameter	Conditions	Typ	Limit		Units
				Min	Max	
$V_{IN}$	Input Voltage	(Note 14)		2	6	V
$\Delta V_{OUT}$	Output Voltage Tolerance	$I_{LOAD} = 1 mA$		-1	+1	%
		Micro SMD		-1.5	+1.5	
		LLP		-1.5	+1.5	
		SOT-23		-1.5	+1.5	
		Over full line and load regulation.		<b>-2.5</b>	<b>+2.5</b>	
		Micro SMD		<b>-3</b>	<b>+3</b>	
		LLP		<b>-3</b>	<b>+3</b>	
		SOT-23		<b>-4</b>	<b>+4</b>	
	Line Regulation Error	$V_{IN} = (V_{OUT(NOM)} + 1.0V)$ to 6.0V,	0.02	<b>-0.1</b>	<b>0.1</b>	%/V
	Load Regulation Error	$I_{OUT} = 1mA$ to 150mA		<b>-0.005</b>	<b>0.005</b>	%mA
		$V_{OUT} = 0.8$ to 1.95V MicroSMD	0.002	<b>-0.005</b>	<b>0.005</b>	
		$V_{OUT} = 0.8$ to 1.95V LLP, SOT-23	0.003	<b>-0.008</b>	<b>0.008</b>	
		$V_{OUT} = 2.0$ to 3.3V MicroSMD	0.0005	<b>-0.002</b>	<b>0.002</b>	
		$V_{OUT} = 2.0$ to 3.3V LLP, SOT-23	0.002	<b>-0.005</b>	<b>0.005</b>	
$V_{DO}$	Dropout Voltage	$I_{OUT} = 150mA$ (Notes 7, 10)	120		<b>200</b>	mV
$I_{LOAD}$	Load Current	(Notes 9, 10)		0		$\mu A$
$I_Q$	Quiescent Current	$V_{EN} = 950mV$ , $I_{OUT} = 0mA$	43		<b>80</b>	$\mu A$
		$V_{EN} = 950mV$ , $I_{OUT} = 150mA$	65		<b>120</b>	
		$V_{EN} = 0.4V$	0.002		0.2	
$I_{SC}$	Short Circuit Current Limit	(Note 11)	550		<b>1000</b>	mA
$I_{OUT}$	Maximum Output Current			<b>150</b>		mA
PSRR	Power Supply Rejection Ratio	$f = 1kHz$ , $I_{OUT} = 1mA$ to 150mA	55			dB
		$f = 10kHz$ , $I_{OUT} = 150mA$	35			

Symbol	Parameter	Conditions	Typ	Limit		Units	
				Min	Max		
$e_n$	Output noise Voltage (Note 10)	BW = 10Hz to 100kHz,	$V_{OUT} = 0.8$	60		$\mu V_{RMS}$	
			$V_{OUT} = 1.5$	125			
			$V_{OUT} = 3.3$	180			
$T_{SHUTDOWN}$	Thermal Shutdown	Temperature	155			$^{\circ}C$	
		Hysteresis	15				
<b>Enable Control Characteristics</b>							
$I_{EN}$ (Note 12)	Maximum Input Current at $V_{EN}$ Input	$V_{EN} = 0.0V$	0.001		0.1	$\mu A$	
		$V_{EN} = 6V$	6	<b>2.5</b>	<b>10</b>		
$V_{IL}$	Low Input Threshold	$V_{IN} = 2V$ to 6V			<b>0.4</b>	V	
$V_{IH}$	High Input Threshold	$V_{IN} = 2V$ to 6V		<b>0.95</b>		V	
<b>Timing Characteristics</b>							
$T_{ON}$	Turn On Time (Note 10)	To 95% Level $V_{IN(MIN)}$ to 6.0V	$V_{OUT} = 0.8$	80		<b>150</b>	$\mu s$
			$V_{OUT} = 1.5$	105		<b>200</b>	
			$V_{OUT} = 3.3$	175		<b>250</b>	
Transient Response	Line Transient Response $ \delta V_{OUT} $	$T_{rise} = T_{fall} = 30\mu s$ (Note 10) $\delta V_{IN} = 600mV$	8		<b>16</b>	mV (pk - pk)	
	Load Transient Response $ \delta V_{OUT} $	$T_{rise} = T_{fall} = 1\mu s$ (Note 10) $I_{OUT} = 1mA$ to 150mA $C_{OUT} = 1\mu F$	55		<b>100</b>	mV	

**Note 1:** Absolute Maximum Ratings are limits beyond which damage can occur. Operating Ratings are conditions under which operation of the device is guaranteed. Operating Ratings do not imply guaranteed performance limits. For guaranteed performance limits and associated test conditions, see the Electrical Characteristics tables.

**Note 2:** All Voltages are with respect to the potential at the GND pin.

**Note 3:** For further information on these packages please refer to the following application notes; AN-1112 Micro SMD Package Wafer Level Chip Scale Package, AN-1187 Leadless Leadframe Package.

**Note 4:** Internal thermal shutdown circuitry protects the device from permanent damage.

**Note 5:** The human body model is 100pF discharged through a 1.5k $\Omega$  resistor into each pin. The machine model is a 200pF capacitor discharged directly into each pin.

**Note 6:** The maximum ambient temperature ( $T_{A(max)}$ ) is dependant on the maximum operating junction temperature ( $T_{J(max-op)} = 125^{\circ}C$ ), the maximum power dissipation of the device in the application ( $P_{D(max)}$ ), and the junction to ambient thermal resistance of the part/package in the application ( $\theta_{JA}$ ), as given by the following equation:  $T_{A(max)} = T_{J(max-op)} - (\theta_{JA} \times P_{D(max)})$ .

**Note 7:** Dropout voltage is voltage difference between input and output at which the output voltage drops to 100mV below its nominal value. This parameter only for output voltages above 2.0V.

**Note 8:** Junction to ambient thermal resistance is dependant on the application and board layout. In applications where high maximum power dissipation is possible, special care must be paid to thermal dissipation issues in board design.

**Note 9:** The device maintains the regulated output voltage without the load.

**Note 10:** This electrical specification is guaranteed by design.

**Note 11:** Short circuit current is measured with  $V_{OUT}$  pulled to 0V and  $V_{IN}$  worst case = 6.0V.

**Note 12:** Enable Pin has 1M $\Omega$  typical, resistor connected to GND.

**Note 13:** All limits are guaranteed. All electrical characteristics having room-temperature limits are tested during production at  $T_J = 25^{\circ}C$  or correlated using Statistical Quality Control methods. Operation over the temperature specification is guaranteed by correlating the electrical characteristics to process and temperature variations and applying statistical process control.

**Note 14:**  $V_{IN(MIN)} = V_{OUT(NOM)} + 0.5V$ , or 2.0V, whichever is higher.

## Output Capacitor, Recommended Specifications

Symbol	Parameter	Conditions	Nom	Limit		Units
				Min	Max	
$C_{OUT}$	Output Capacitance	Capacitance (Note 15)	1.0	<b>0.7</b>		$\mu F$
		ESR		5	500	m $\Omega$

**Note 15:** The full operating conditions for the application should be considered when selecting a suitable capacitor to ensure that the minimum value of capacitance is always met. Recommended capacitor type is X7R. However, dependent on application, X5R, Y5V, and Z5U can also be used. (See capacitor section in Applications Hints)

**Typical Performance Characteristics.** Unless otherwise specified,  $C_{IN} = 1.0\mu\text{F}$  Ceramic,  $C_{OUT} = 0.47\mu\text{F}$  Ceramic,  $V_{IN} = V_{OUT(NOM)} + 1.0\text{V}$ ,  $T_A = 25^\circ\text{C}$ ,  $V_{OUT(NOM)} = 1.5\text{V}$ , Shutdown pin is tied to  $V_{IN}$ .

**Output Voltage Change vs Temperature**

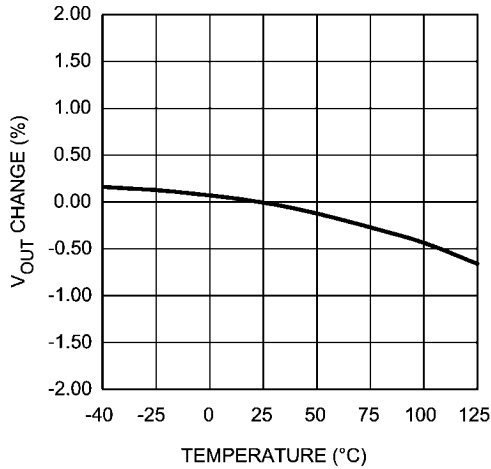

20076810

**Ground Current vs Load Current**

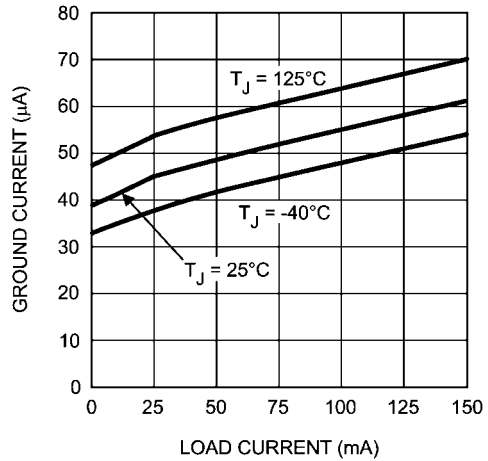

20076831

**Ground Current vs V<sub>IN</sub>, I<sub>LOAD</sub> = 0mA**

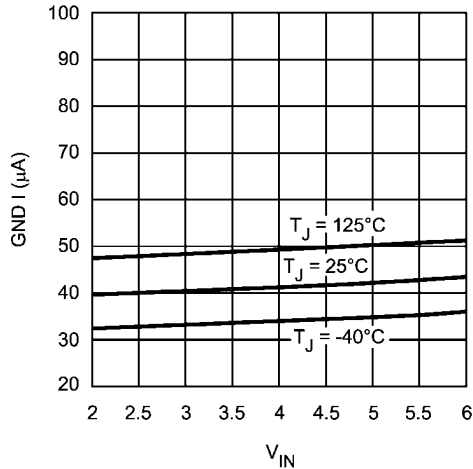

20076812

**Ground Current vs V<sub>IN</sub>, I<sub>LOAD</sub> = 1mA**

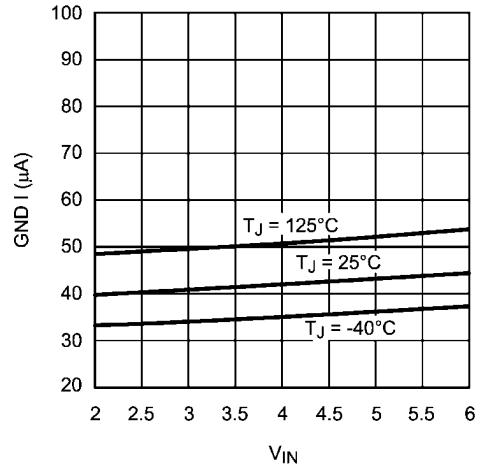

20076813

**Ground Current vs V<sub>IN</sub>, I<sub>LOAD</sub> = 150mA**

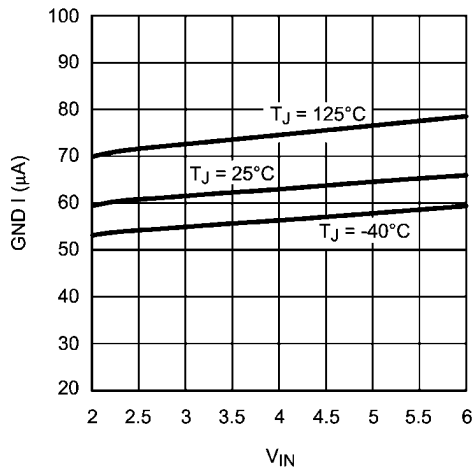

20076814

**Short Circuit Current**

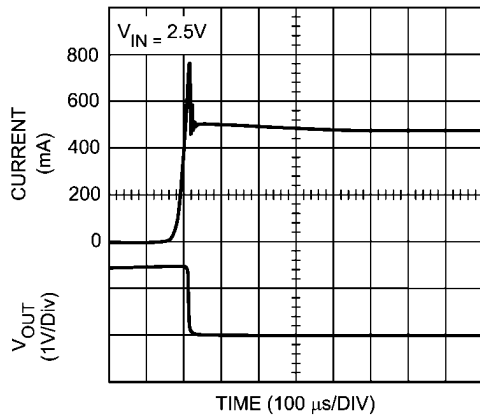

20076815

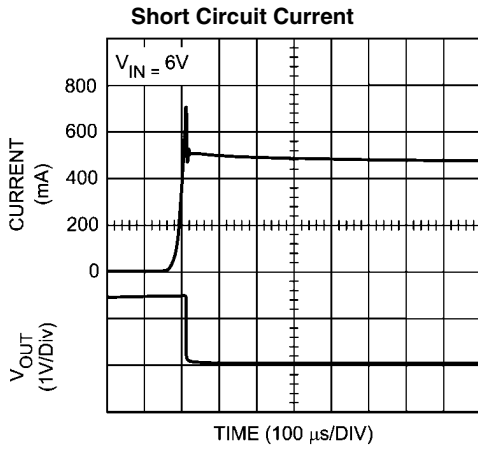

20076816

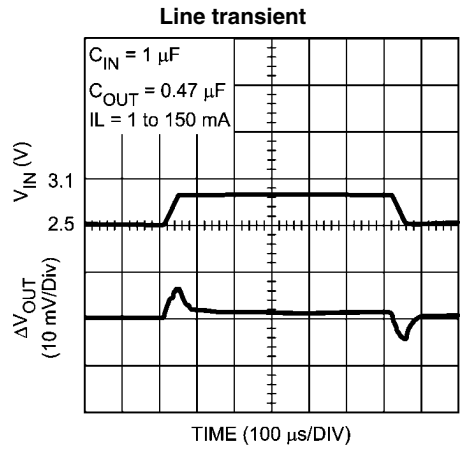

20076817

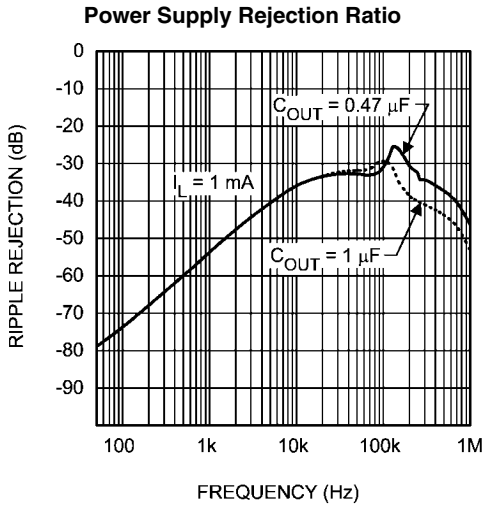

20076819

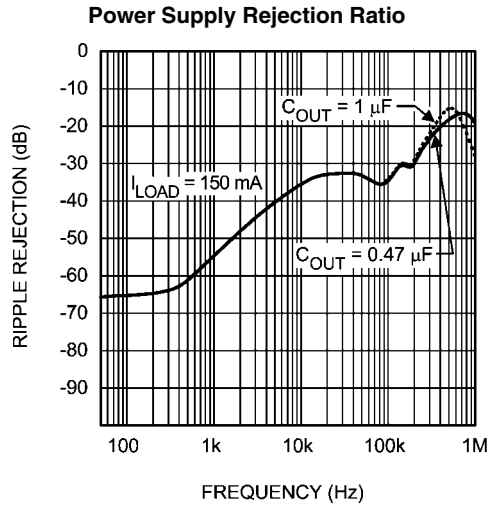

20076820

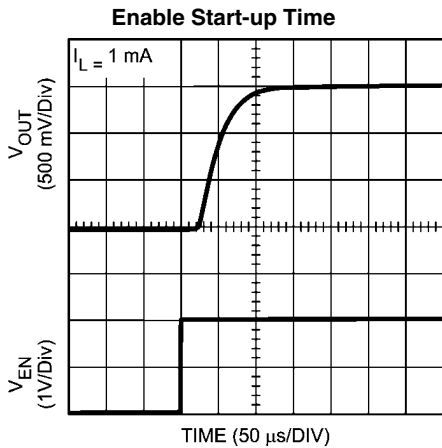

20076821

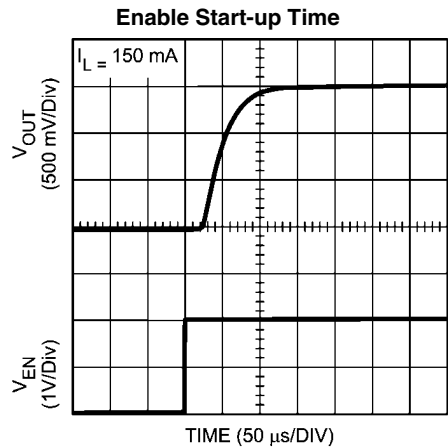

20076822

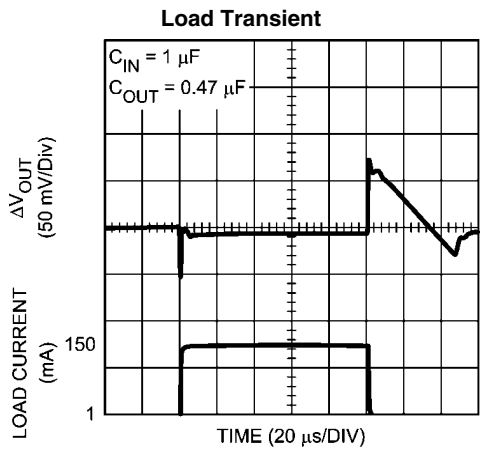

20076825

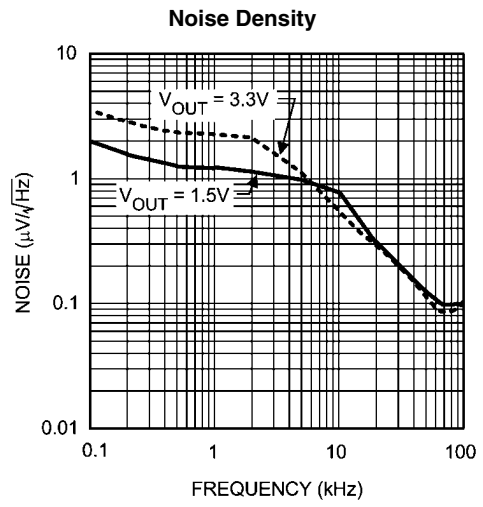

20076828

## Application Hints

### EXTERNAL CAPACITORS

In common with most regulators, the LP3990 requires external capacitors for regulator stability. The LP3990 is specifically designed for portable applications requiring minimum board space and smallest components. These capacitors must be correctly selected for good performance.

### INPUT CAPACITOR

An input capacitor is required for stability. It is recommended that a 1.0 $\mu$ F capacitor be connected between the LP3990 input pin and ground (this capacitance value may be increased without limit).

This capacitor must be located a distance of not more than 1cm from the input pin and returned to a clean analogue ground. Any good quality ceramic, tantalum, or film capacitor may be used at the input.

**Important:** To ensure stable operation it is essential that good PCB design practices are employed to minimize ground impedance and keep input inductance low. If these conditions cannot be met, or if long leads are used to connect the battery or other power source to the LP3990, then it is recommended that the input capacitor is increased. Also, tantalum capacitors can suffer catastrophic failures due to surge current when connected to a low-impedance source of power (like a battery or a very large capacitor). If a tantalum capacitor is used at the input, it must be guaranteed by the manufacturer to have a surge current rating sufficient for the application.

There are no requirements for the ESR (Equivalent Series Resistance) on the input capacitor, but tolerance and temperature coefficient must be considered when selecting the capacitor to ensure the capacitance will remain approximately 1.0 $\mu$ F over the entire operating temperature range.

### OUTPUT CAPACITOR

The LP3990 is designed specifically to work with very small ceramic output capacitors. A 1.0 $\mu$ F ceramic capacitor (temperature types Z5U, Y5V or X7R) with ESR between 5m $\Omega$  to 500m $\Omega$ , is suitable in the LP3990 application circuit.

For this device the output capacitor should be connected between the  $V_{OUT}$  pin and ground.

It is also possible to use tantalum or film capacitors at the device output,  $C_{OUT}$  (or  $V_{OUT}$ ), but these are not as attractive for reasons of size and cost (see the section Capacitor Characteristics).

The output capacitor must meet the requirement for the minimum value of capacitance and also have an ESR value that is within the range 5m $\Omega$  to 500m $\Omega$  for stability.

### NO-LOAD STABILITY

The LP3990 will remain stable and in regulation with no external load. This is an important consideration in some circuits, for example CMOS RAM keep-alive applications.

### CAPACITOR CHARACTERISTICS

The LP3990 is designed to work with ceramic capacitors on the output to take advantage of the benefits they offer. For capacitance values in the range of 0.47 $\mu$ F to 4.7 $\mu$ F, ceramic capacitors are the smallest, least expensive and have the lowest ESR values, thus making them best for eliminating high frequency noise. The ESR of a typical 1.0 $\mu$ F ceramic capacitor is in the range of 20m $\Omega$  to 40m $\Omega$ , which easily meets the ESR requirement for stability for the LP3990.

For both input and output capacitors, careful interpretation of the capacitor specification is required to ensure correct device operation. The capacitor value can change greatly, depending on the operating conditions and capacitor type.

In particular, the output capacitor selection should take account of all the capacitor parameters, to ensure that the specification is met within the application. The capacitance can vary with DC bias conditions as well as temperature and frequency of operation. Capacitor values will also show some decrease over time due to aging. The capacitor parameters are also dependant on the particular case size, with smaller sizes giving poorer performance figures in general. As an example, *Figure 1* shows a typical graph comparing different capacitor case sizes in a Capacitance vs. DC Bias plot. As shown in the graph, increasing the DC Bias condition can result in the capacitance value falling below the minimum value given in the recommended capacitor specifications table (0.7 $\mu$ F in this case). Note that the graph shows the capacitance out of spec for the 0402 case size capacitor at higher bias voltages. It is therefore recommended that the capacitor manufacturers' specifications for the nominal value capacitor are consulted for all conditions, as some capacitor sizes (e.g. 0402) may not be suitable in the actual application.

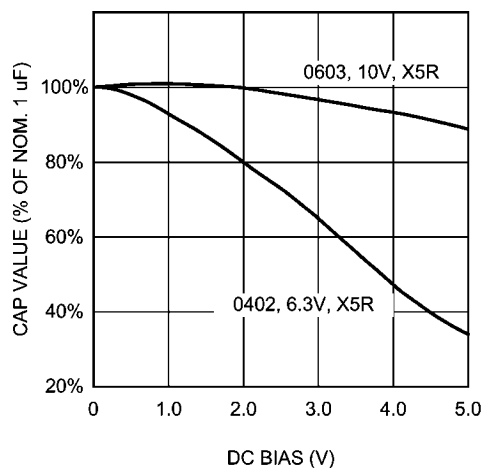

20076840

**FIGURE 1. Graph Showing a Typical Variation in Capacitance vs DC Bias**

The ceramic capacitor's capacitance can vary with temperature. The capacitor type X7R, which operates over a temperature range of -55 $^{\circ}$ C to +125 $^{\circ}$ C, will only vary the capacitance to within  $\pm$ 15%. The capacitor type X5R has a similar tolerance over a reduced temperature range of -55 $^{\circ}$ C to +85 $^{\circ}$ C. Many large value ceramic capacitors, larger than 1 $\mu$ F are manufactured with Z5U or Y5V temperature characteristics. Their capacitance can drop by more than 50% as the temperature varies from 25 $^{\circ}$ C to 85 $^{\circ}$ C. Therefore X7R is recommended over Z5U and Y5V in applications where the ambient temperature will change significantly above or below 25 $^{\circ}$ C.

Tantalum capacitors are less desirable than ceramic for use as output capacitors because they are more expensive when comparing equivalent capacitance and voltage ratings in the 0.47 $\mu$ F to 4.7 $\mu$ F range.

Another important consideration is that tantalum capacitors have higher ESR values than equivalent size ceramics. This means that while it may be possible to find a tantalum capacitor with an ESR value within the stable range, it would have to be larger in capacitance (which means bigger and more

costly) than a ceramic capacitor with the same ESR value. It should also be noted that the ESR of a typical tantalum will increase about 2:1 as the temperature goes from 25°C down to -40°C, so some guard band must be allowed.

#### **ENABLE CONTROL**

The LP3990 features an active high Enable pin,  $V_{EN}$ , which turns the device on when pulled high. When not enabled the regulator output is off and the device typically consumes 2nA. If the application does not require the Enable switching feature, the  $V_{EN}$  pin should be tied to  $V_{IN}$  to keep the regulator output permanently on.

To ensure proper operation, the signal source used to drive the  $V_{EN}$  input must be able to swing above and below the specified turn-on/off voltage thresholds listed in the Electrical Characteristics section under  $V_{IL}$  and  $V_{IH}$ .

#### **Micro SMD MOUNTING**

The micro SMD package requires specific mounting techniques, which are detailed in National Semiconductor Application Note AN-1112.

For best results during assembly, alignment ordinals on the PC board may be used to facilitate placement of the micro SMD device.

#### **Micro SMD LIGHT SENSITIVITY**

Exposing the micro SMD device to direct light may affect the operation of the device. Light sources, such as halogen lamps, can affect electrical performance, if placed in close proximity to the device.

Light with wavelengths in the infra-red portion of the spectrum is the most detrimental, and so, fluorescent lighting used inside most buildings, has little or no effect on performance.

**Physical Dimensions** inches (millimeters) unless otherwise noted

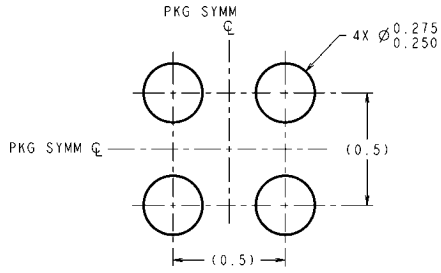

**DIMENSIONS ARE IN MILLIMETERS**  
 DIMENSIONS IN ( ) FOR REFERENCE ONLY

**LAND PATTERN RECOMMENDATION**

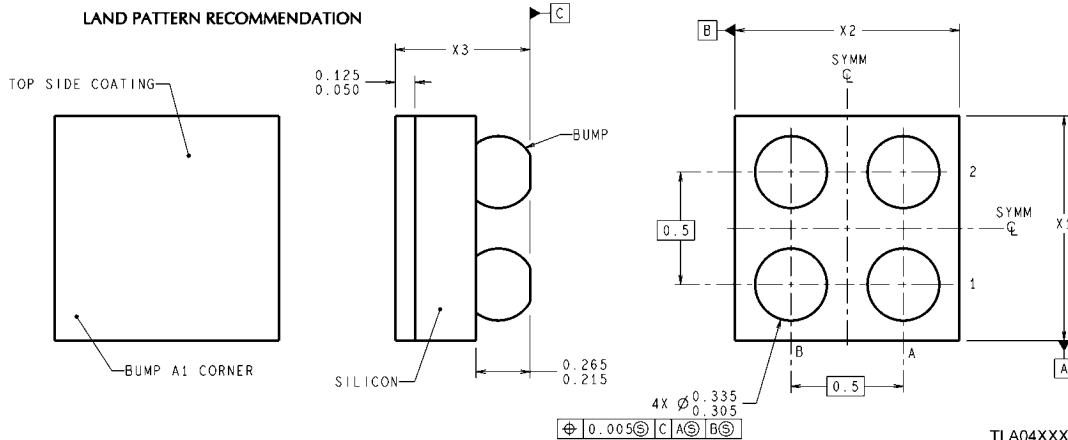

TLA04XXX (Rev D)

**micro SMD, 4 Bump, Package (TLA04)**  
**NS Package Number TLA04AMA**  
**The dimensions for X1, X2 and X3 are given as:**  
**X1 = 1.014 +/- 0.03mm**  
**X2 = 1.294 +/- 0.03mm**  
**X3 = 0.600 +/- 0.075mm**

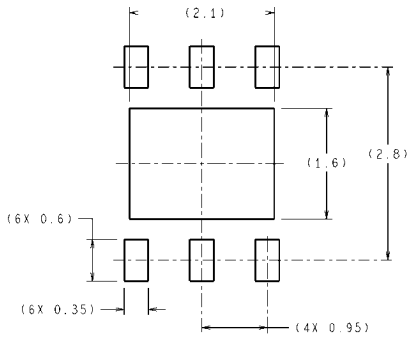

DIMENSIONS ARE IN MILLIMETERS  
DIMENSION IN ( ) FOR REFERENCE ONLY

RECOMMENDED LAND PATTERN

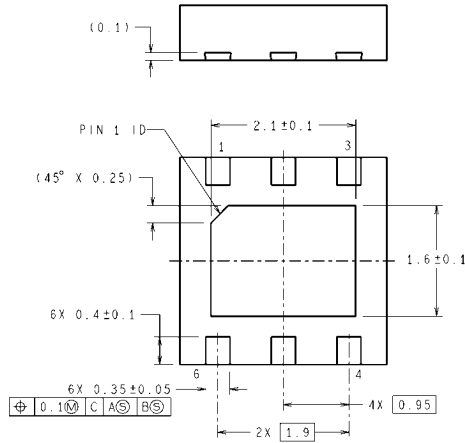
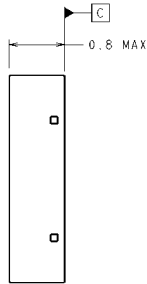
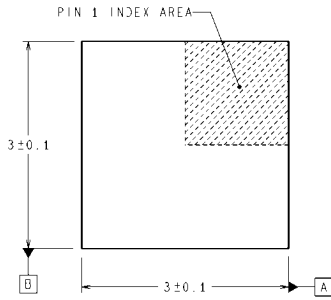

SDE06A (Rev A)

LLP, 6 Lead, Package (SOT23 Land)  
NS Package Number SDE06A

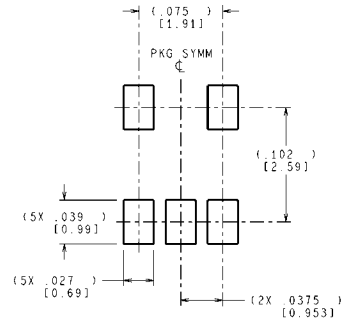
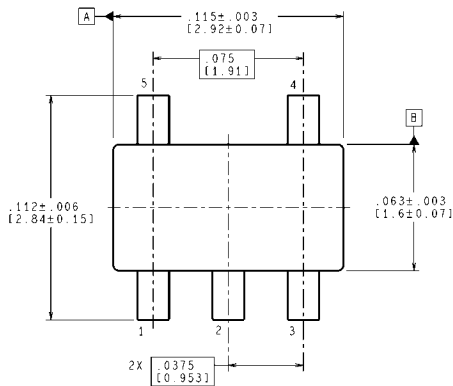

LAND PATTERN RECOMMENDATION

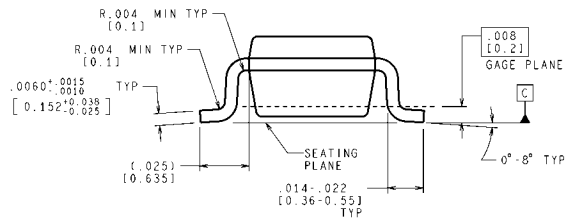
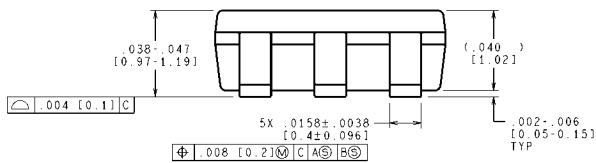

CONTROLLING DIMENSION IS INCH  
VALUES IN ( ) ARE MILLIMETERS  
DIMENSIONS IN ( ) FOR REFERENCE ONLY

SOT23 - 5 Package  
NS Package Number MF05A

MF05A (Rev D)

## Notes

For more National Semiconductor product information and proven design tools, visit the following Web sites at:

Products		Design Support	
Amplifiers	<a href="http://www.national.com/amplifiers">www.national.com/amplifiers</a>	WEBENCH	<a href="http://www.national.com/webench">www.national.com/webench</a>
Audio	<a href="http://www.national.com/audio">www.national.com/audio</a>	Analog University	<a href="http://www.national.com/AU">www.national.com/AU</a>
Clock Conditioners	<a href="http://www.national.com/timing">www.national.com/timing</a>	App Notes	<a href="http://www.national.com/appnotes">www.national.com/appnotes</a>
Data Converters	<a href="http://www.national.com/adc">www.national.com/adc</a>	Distributors	<a href="http://www.national.com/contacts">www.national.com/contacts</a>
Displays	<a href="http://www.national.com/displays">www.national.com/displays</a>	Green Compliance	<a href="http://www.national.com/quality/green">www.national.com/quality/green</a>
Ethernet	<a href="http://www.national.com/ethernet">www.national.com/ethernet</a>	Packaging	<a href="http://www.national.com/packaging">www.national.com/packaging</a>
Interface	<a href="http://www.national.com/interface">www.national.com/interface</a>	Quality and Reliability	<a href="http://www.national.com/quality">www.national.com/quality</a>
LVDS	<a href="http://www.national.com/lvds">www.national.com/lvds</a>	Reference Designs	<a href="http://www.national.com/refdesigns">www.national.com/refdesigns</a>
Power Management	<a href="http://www.national.com/power">www.national.com/power</a>	Feedback	<a href="http://www.national.com/feedback">www.national.com/feedback</a>
Switching Regulators	<a href="http://www.national.com/switchers">www.national.com/switchers</a>		
LDOs	<a href="http://www.national.com/lido">www.national.com/lido</a>		
LED Lighting	<a href="http://www.national.com/led">www.national.com/led</a>		
PowerWise	<a href="http://www.national.com/powerwise">www.national.com/powerwise</a>		
Serial Digital Interface (SDI)	<a href="http://www.national.com/sdi">www.national.com/sdi</a>		
Temperature Sensors	<a href="http://www.national.com/tempsensors">www.national.com/tempsensors</a>		
Wireless (PLL/VCO)	<a href="http://www.national.com/wireless">www.national.com/wireless</a>		

THE CONTENTS OF THIS DOCUMENT ARE PROVIDED IN CONNECTION WITH NATIONAL SEMICONDUCTOR CORPORATION ("NATIONAL") PRODUCTS. NATIONAL MAKES NO REPRESENTATIONS OR WARRANTIES WITH RESPECT TO THE ACCURACY OR COMPLETENESS OF THE CONTENTS OF THIS PUBLICATION AND RESERVES THE RIGHT TO MAKE CHANGES TO SPECIFICATIONS AND PRODUCT DESCRIPTIONS AT ANY TIME WITHOUT NOTICE. NO LICENSE, WHETHER EXPRESS, IMPLIED, ARISING BY ESTOPPEL OR OTHERWISE, TO ANY INTELLECTUAL PROPERTY RIGHTS IS GRANTED BY THIS DOCUMENT.

TESTING AND OTHER QUALITY CONTROLS ARE USED TO THE EXTENT NATIONAL DEEMS NECESSARY TO SUPPORT NATIONAL'S PRODUCT WARRANTY. EXCEPT WHERE MANDATED BY GOVERNMENT REQUIREMENTS, TESTING OF ALL PARAMETERS OF EACH PRODUCT IS NOT NECESSARILY PERFORMED. NATIONAL ASSUMES NO LIABILITY FOR APPLICATIONS ASSISTANCE OR BUYER PRODUCT DESIGN. BUYERS ARE RESPONSIBLE FOR THEIR PRODUCTS AND APPLICATIONS USING NATIONAL COMPONENTS. PRIOR TO USING OR DISTRIBUTING ANY PRODUCTS THAT INCLUDE NATIONAL COMPONENTS, BUYERS SHOULD PROVIDE ADEQUATE DESIGN, TESTING AND OPERATING SAFEGUARDS.

EXCEPT AS PROVIDED IN NATIONAL'S TERMS AND CONDITIONS OF SALE FOR SUCH PRODUCTS, NATIONAL ASSUMES NO LIABILITY WHATSOEVER, AND NATIONAL DISCLAIMS ANY EXPRESS OR IMPLIED WARRANTY RELATING TO THE SALE AND/OR USE OF NATIONAL PRODUCTS INCLUDING LIABILITY OR WARRANTIES RELATING TO FITNESS FOR A PARTICULAR PURPOSE, MERCHANTABILITY, OR INFRINGEMENT OF ANY PATENT, COPYRIGHT OR OTHER INTELLECTUAL PROPERTY RIGHT.

### LIFE SUPPORT POLICY

**NATIONAL'S PRODUCTS ARE NOT AUTHORIZED FOR USE AS CRITICAL COMPONENTS IN LIFE SUPPORT DEVICES OR SYSTEMS WITHOUT THE EXPRESS PRIOR WRITTEN APPROVAL OF THE CHIEF EXECUTIVE OFFICER AND GENERAL COUNSEL OF NATIONAL SEMICONDUCTOR CORPORATION.** As used herein:

Life support devices or systems are devices which (a) are intended for surgical implant into the body, or (b) support or sustain life and whose failure to perform when properly used in accordance with instructions for use provided in the labeling can be reasonably expected to result in a significant injury to the user. A critical component is any component in a life support device or system whose failure to perform can be reasonably expected to cause the failure of the life support device or system or to affect its safety or effectiveness.

National Semiconductor and the National Semiconductor logo are registered trademarks of National Semiconductor Corporation. All other brand or product names may be trademarks or registered trademarks of their respective holders.

Copyright© 2008 National Semiconductor Corporation

For the most current product information visit us at [www.national.com](http://www.national.com)



**National Semiconductor Americas Technical Support Center**  
 Email: [support@nsc.com](mailto:support@nsc.com)  
 Tel: 1-800-272-9959

**National Semiconductor Europe Technical Support Center**  
 Email: [europe.support@nsc.com](mailto:europe.support@nsc.com)  
 German Tel: +49 (0) 180 5010 771  
 English Tel: +44 (0) 870 850 4288

**National Semiconductor Asia Pacific Technical Support Center**  
 Email: [ap.support@nsc.com](mailto:ap.support@nsc.com)

**National Semiconductor Japan Technical Support Center**  
 Email: [jpn.feedback@nsc.com](mailto:jpn.feedback@nsc.com)

## Looking for pricing, stock, or lifecycle information?

Click below to explore more details on WIN SOURCE:

 [View LP3990SD-0.8/NOPB on WIN SOURCE](#)

 [Texas Instruments](#) Information

## Optimize Your Supply Chain with WIN SOURCE Solutions

-  Global Sourcing Solution
-  Obsolete Management
-  Cost Control Management
-  Shortage Management
-  Alternative Solution
-  Excess Inventory Management