



**THE DATASHEET OF  
LQG21C220N00T1**



**CHIP COIL (CHIP INDUCTORS) LQM21DN□□□□00□ REFERENCE SPECIFICATION**
**1. Scope**

This reference specification applies to LQM21DN series, Chip coil (Chip Inductors).

**2. Part Numbering**

|      |            |           |                    |                                        |          |            |           |          |           |                                                                      |  |
|------|------------|-----------|--------------------|----------------------------------------|----------|------------|-----------|----------|-----------|----------------------------------------------------------------------|--|
| (ex) | LQ         | M         | 21                 | D                                      | N        | 1R0        | N         | 0        | 0         | D                                                                    |  |
|      | Product ID | Structure | Dimension<br>(L×W) | Applications<br>and<br>Characteristics | Category | Inductance | Tolerance | Features | Electrode | Packaging                                                            |  |
|      |            |           |                    |                                        |          |            |           |          |           | D: Taping<br>(Paper tape)<br>L: Taping<br>(Plastic tape)<br>*B: Bulk |  |

\*B: Bulk packing also available

**3. Rating**

- Operating Temperature Range      – 40°C to + 85°C
- Storage Temperature Range       – 55°C to +125°C

| Customer Part Number | MURATA Part Number | Inductance |           | DC Resistance<br>(Ω max.) | Self Resonant Frequency<br>(MHz min.) | Rated Current<br>(mA) |
|----------------------|--------------------|------------|-----------|---------------------------|---------------------------------------|-----------------------|
|                      |                    | (μH)       | Tolerance |                           |                                       |                       |
|                      | LQM21DN1R0N00D     | 1.0        | ±30%      | 0.10                      | 75                                    | 60                    |
|                      | LQM21DN2R2N00D     | 2.2        |           | 0.17                      | 50                                    | 40                    |
|                      | LQM21DN4R7N00D     | 4.7        |           | 0.30                      | 35                                    | 30                    |
|                      | LQM21DN100N00D     | 10         |           | 0.50                      | 24                                    | 15                    |
|                      | LQM21DN220N00L     | 22         |           | 0.65                      | 16                                    | 13                    |
|                      | LQM21DN470N00L     | 47         |           | 1.20                      | 7.5                                   | 7                     |

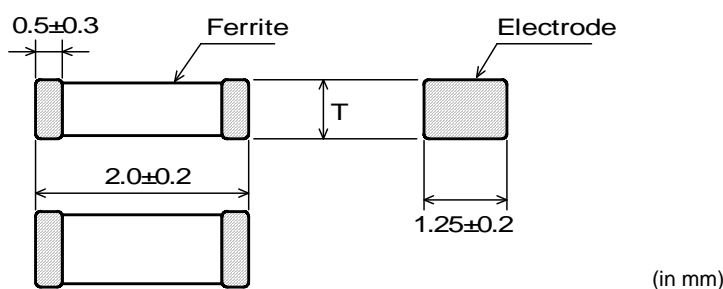
**4. Appearance and Dimensions**

| Dimension of T | Inductance: 1.0μH to 10μH | 0.85mm±0.2mm             |
|----------------|---------------------------|--------------------------|
|                |                           | Inductance: 22μH to 47μH |

| Unit Mass<br>(Typical value) | Inductance: 1.0μH to 10μH | 0.010g                   |
|------------------------------|---------------------------|--------------------------|
|                              |                           | Inductance: 22μH to 47μH |

**5. Testing Conditions**

«Unless otherwise specified»

Temperature : Ordinary Temperature / 15°C to 35°C  
 Humidity : Ordinary Humidity / 25%(RH) to 85%(RH)

«In case of doubt»

Temperature : 20°C ± 2°C  
 Humidity : 60%(RH) to 70%(RH)  
 Atmospheric Pressure : 86kPa to 106kPa

## 6. Electrical Performance

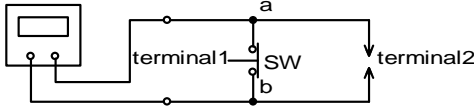
| No. | Item                            | Specification                                                                         | Test Method                                                                                                                                                                                                                                                                                                                                                                                                     |
|-----|---------------------------------|---------------------------------------------------------------------------------------|-----------------------------------------------------------------------------------------------------------------------------------------------------------------------------------------------------------------------------------------------------------------------------------------------------------------------------------------------------------------------------------------------------------------|
| 6.1 | Inductance                      | Inductance shall meet item 3.                                                         | Measuring Equipment:<br>Agilent 4291A or equivalent (1mA)<br>Measuring Frequency: 1MHz                                                                                                                                                                                                                                                                                                                          |
| 6.2 | DC Resistance                   | DC Resistance shall meet item 3.                                                      | Measuring Equipment: Digital multi meter<br>Digital multi meter<br>(TR6846 or equivalent)<br><br>DC resistance shall be measured after putting chip coil between the terminal 2 under the condition of opening between a and b.<br>Every measurement the terminal 1 shall be shorted between a and b when changing chip coil. |
| 6.3 | Self Resonant Frequency (S.R.F) | S.R.F shall meet item 3.                                                              | Measuring Equipment:<br>Agilent 4195A or equivalent (1mA)                                                                                                                                                                                                                                                                                                                                                       |
| 6.4 | Rated Current                   | Self temperature rise shall be limited to 20°C max.<br>Inductance Change: within ±50% | The rated current is applied.                                                                                                                                                                                                                                                                                                                                                                                   |

## 7. Mechanical Performance

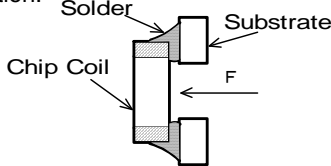
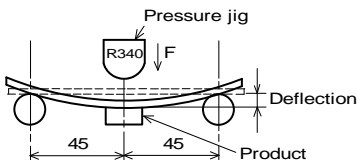
| No. | Item                         | Specification                                                                            | Test Method                                                                                                                                                                                                                                                        |
|-----|------------------------------|------------------------------------------------------------------------------------------|--------------------------------------------------------------------------------------------------------------------------------------------------------------------------------------------------------------------------------------------------------------------|
| 7.1 | Shear Test                   | Chip coil shall not be damaged after tested as test method.                              | Applied Direction:<br><br>Force: 10N<br>Hold Duration: 5 s±1 s                                                                                                                  |
| 7.2 | Bending Test                 | Chip coil shall not be damaged after tested as test method.                              | Substrate: Glass-epoxy substrate<br>(100mm×40mm×1.6mm)<br><br>Speed of Applying Force: 1mm / s<br>Deflection: 2mm<br>Hold Duration: 30s<br>(in mm)                             |
| 7.3 | Vibration                    | Chip coil shall not be damaged after tested as test method.                              | Oscillation Frequency:<br>10Hz to 55Hz to 10Hz for 1 min<br>Total Amplitude: 1.5mm<br>Testing Time: A period of 2 h in each of 3 mutually Perpendicular directions.                                                                                                |
| 7.4 | Solderability                | The wetting area of the electrode shall be at least 90% covered with new solder coating. | Flux: Ethanol solution of rosin 25(wt)%<br>(Immersed for 5s to 10s)<br>Solder: Sn-3.0Ag-0.5Cu<br>Pre-Heating: 150°C±10°C / 60s to 90s<br>Solder Temperature: 240°C±5°C<br>Immersion Time: 3s±1s                                                                    |
| 7.5 | Resistance to Soldering Heat | Appearance: No damage<br>Inductance Change: within ±20%                                  | Flux: Ethanol solution of rosin 25(wt)%<br>(Immersed for 5s to 10s)<br>Solder: Sn-3.0Ag-0.5Cu<br>Pre-Heating: 150°C±10°C / 60s to 90s<br>Solder Temperature: 270°C±5°C<br>Immersion Time: 10s±1s<br>Then measured after exposure in the room condition for 24h±2h. |

### 8. Environmental Performance

It shall be soldered on the substrate.

| No. | Item              | Specification                                                 | Test Method                                                                                                                                                                                                                                                                                                                                                             |
|-----|-------------------|---------------------------------------------------------------|-------------------------------------------------------------------------------------------------------------------------------------------------------------------------------------------------------------------------------------------------------------------------------------------------------------------------------------------------------------------------|
| 8.1 | Heat Resistance   | Appearance: No damage<br>Inductance Change: within $\pm 20\%$ | Temperature: $85^{\circ}\text{C} \pm 2^{\circ}\text{C}$<br>Time: 1000 h (+48h, -0h)<br>Then measured after exposure in the room condition for $48\text{h} \pm 2\text{h}$ .                                                                                                                                                                                              |
| 8.2 | Cold Resistance   |                                                               | Temperature: $-40^{\circ}\text{C} \pm 2^{\circ}\text{C}$<br>Time: 1000 h (+48h, -0h)<br>Then measured after exposure in the room condition for $48\text{h} \pm 2\text{h}$ .                                                                                                                                                                                             |
| 8.3 | Humidity          |                                                               | Temperature: $40^{\circ}\text{C} \pm 2^{\circ}\text{C}$<br>Humidity: 90%(RH) to 95%(RH)<br>Time: 1000 h (+48h, -0h)<br>Then measured after exposure in the room condition for $48\text{h} \pm 2\text{h}$ .                                                                                                                                                              |
| 8.4 | Temperature Cycle |                                                               | 1 cycle:<br>1 step: $-40^{\circ}\text{C} \pm 2^{\circ}\text{C}$ / 30 min $\pm$ 3 min<br>2 step: Ordinary temp. / 10 min to 15 min<br>3 step: $+85^{\circ}\text{C} \pm 2^{\circ}\text{C}$ / 30 min $\pm$ 3 min<br>4 step: Ordinary temp. / 10 min to 15 min<br>Total of 10 cycles<br>Then measured after exposure in the room condition for $48\text{h} \pm 2\text{h}$ . |

### 9. Specification of Packaging

#### 9.1 Appearance and Dimensions of paper tape, plastic tape (8mm-wide)

| P/N                                                | Type                     | Dimensions (in mm)                                               |
|----------------------------------------------------|--------------------------|------------------------------------------------------------------|
| LQM21D<br>1R0N00D<br>2R2N00D<br>4R7N00D<br>100N00D | 8mm-wide<br>Paper tape   |                                                                  |
| LQM21D<br>220N00L<br>470N00L                       | 8mm-wide<br>Plastic tape | <p>• Dimension of the Cavity is measured at the bottom side.</p> |

**9.2 Specification of Taping**

- (1) Packing quantity (standard quantity)
  - Inductance : 1.0 $\mu$ H to 10 $\mu$ H (Paper tape)    4,000 pcs / reel
  - Inductance : 22 $\mu$ H to 47  $\mu$ H (Plastic tape)    3,000 pcs / reel
- (2) Packing Method
  - (Paper tape)  
Products shall be packed in the cavity of the base tape and sealed by top tape and bottom tape.
  - (Plastic tape)  
Products shall be packed in the each embossed cavity of plastic tape and sealed by cover tape.
- (3) Sprocket hole  
The sprocket holes are to the right as the tape is pulled toward the user.
- (4) Spliced point
  - (Paper tape)  
Base tape and Top tape has no spliced point.
  - (Plastic tape)  
Plastic tape and Cover tape has no spliced point.
- (5) Missing components number  
Missing components number within 0.1% of the number per reel or 1 pc., whichever is greater, and are not continuous. The Specified quantity per reel is kept.

**9.3 Pull Strength**

**【Case of Paper tape】**

|             |         |
|-------------|---------|
| Top tape    | 5N min. |
| Bottom tape |         |

**【Case of Plastic tape】**

|              |          |
|--------------|----------|
| Plastic tape | 10N min. |
| Cover tape   | 5N min.  |

**9.4 Peeling off force**

**【Case of Paper tape】**

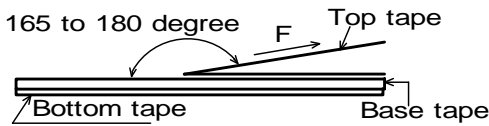

**【Case of Plastic tape】**

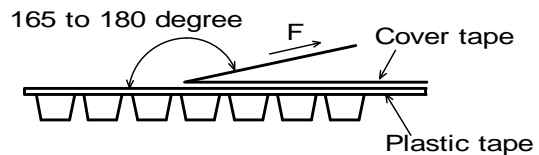

|                      |                                                                                      |
|----------------------|--------------------------------------------------------------------------------------|
| Speed of Peeling off | 300mm / min                                                                          |
| Peeling off force    | Paper tape: 0.1N to 0.6N<br>Plastic tape: 0.2N to 0.7N<br>(minimum value is typical) |

**9.5 Dimensions of Leader-tape, Trailer and Reel**

There shall be leader-tape ( top tape / cover tape and empty tape) and trailer-tape (empty tape) as follows.

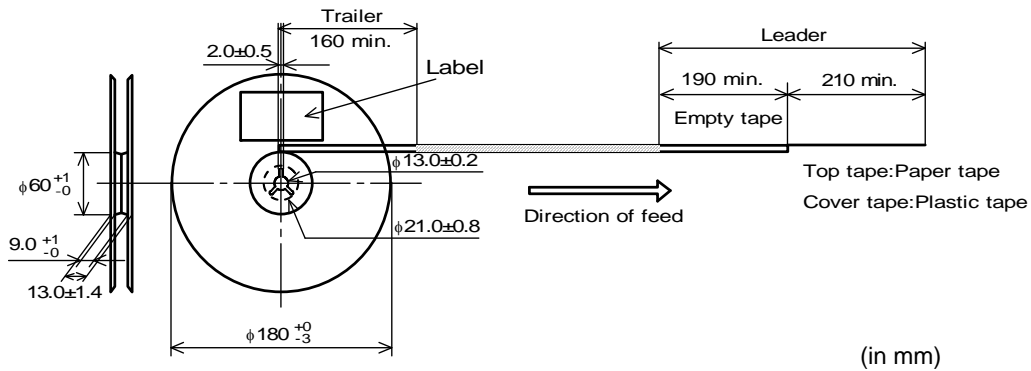

**9.6 Marking for reel**

Customer part number, MURATA part number, Inspection number (\*1), RoHS Marking (\*2), Quantity etc ...

\*1) <Expression of Inspection No.> □□ 0000 ×××  
(1) (2) (3)

- (1) Factory Code
- (2) Date      First digit      : Year / Last digit of year  
                   Second digit    : Month / Jan. to Sep. → 1 to 9, Oct. to Dec. → O, N, D  
                   Third, Fourth digit : Day
- (3) Serial No.

\*2) <Expression of RoHS Marking > ROHS – Y (Δ)  
(1) (2)

- (1) RoHS regulation conformity parts.
- (2) MURATA classification number

**9.7 Marking for Outside package (corrugated paper box)**

Customer name, Purchasing order number, Customer part number, MURATA part number, RoHS Marking (\*2), Quantity, etc ...

**9.8. Specification of Outer Case**

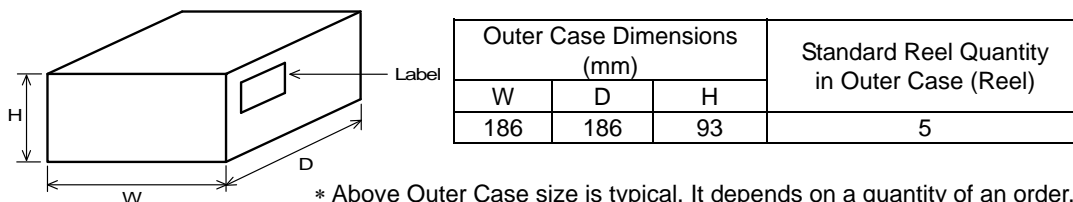

**10. ⚠ Caution**

**Limitation of Applications**

Please contact us before using our products for the applications listed below which require especially high reliability for the prevention of defects which might directly cause damage to the third party's life, body or property.

- (1) Aircraft equipment
- (2) Aerospace equipment
- (3) Undersea equipment
- (4) Power plant control equipment
- (5) Medical equipment
- (6) Transportation equipment (vehicles, trains, ships, etc.)
- (7) Traffic signal equipment
- (8) Disaster prevention / crime prevention equipment
- (9) Data-processing equipment
- (10) Applications of similar complexity and /or reliability requirements to the applications listed in the above

**11. Notice**

This product is designed for solder mounting.  
 Please consult us in advance for applying other mounting method such as conductive adhesive.

**11.1 Land pattern designing**

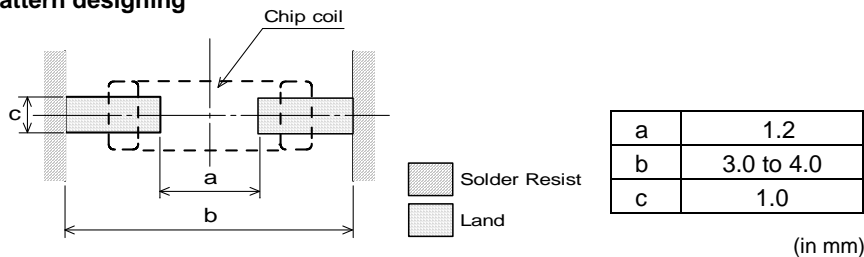

**11.2 Flux, Solder**

- Use rosin-based flux.  
 Don't use highly acidic flux with halide content exceeding 0.2(wt)% (chlorine conversion value).  
 Don't use water-soluble flux.
- Use Sn-3.0Ag-0.5Cu solder.
- Standard thickness of solder paste: 100µm to 150µm.

### 11.3 Flow soldering / Reflow soldering conditions

- Pre-heating should be in such a way that the temperature difference between solder and product surface is limited to 150°C max. Cooling into solvent after soldering also should be in such a way that the temperature difference is limited to 100°C max. Insufficient pre-heating may cause cracks on the product, resulting in the deterioration of products quality.
- Standard soldering profile and the limit soldering profile is as follows. The excessive limit soldering conditions may cause leaching of the electrode and / or resulting in the deterioration of product quality.

#### Soldering profile

##### (1) Flow soldering profile

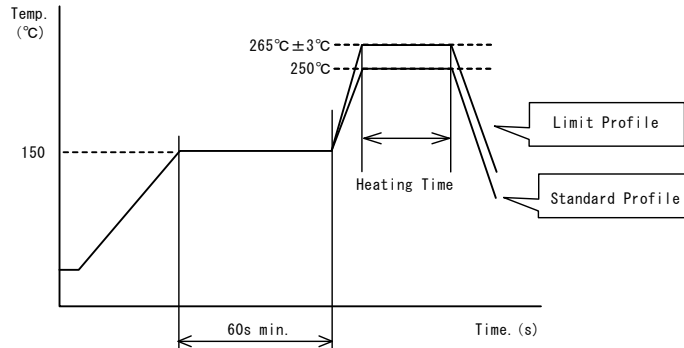

|               | Standard Profile | Limit Profile |
|---------------|------------------|---------------|
| Pre-heating   | 150°C, 60s min.  |               |
| Heating       | 250°C, 4s~6s     | 265°C±3°C, 5s |
| Cycle of flow | 2 times          | 2 times       |

##### (2) Reflow soldering profile

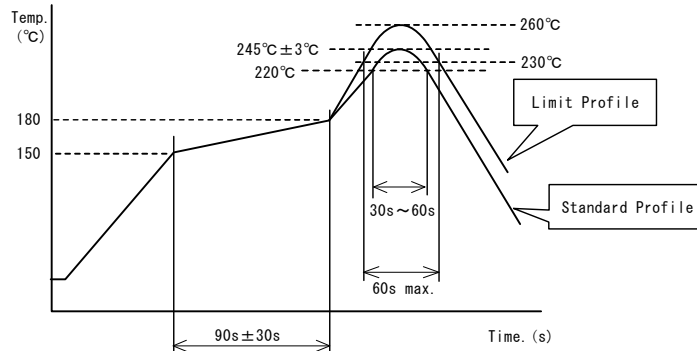

|                  | Standard Profile     | Limit Profile         |
|------------------|----------------------|-----------------------|
| Pre-heating      | 150°C~180°C, 90s±30s |                       |
| Heating          | above 220°C, 30s~60s | above 230°C, 60s max. |
| Peak temperature | 245°C±3°C            | 260°C, 10s            |
| Cycle of reflow  | 2 times              | 2 times               |

### 11.4 Reworking with soldering iron.

The following conditions must be strictly followed when using a soldering iron.

|                       |              |
|-----------------------|--------------|
| Pre-heating           | 150°C, 1 min |
| Tip temperature       | 350°C max.   |
| Soldering iron output | 80W max.     |
| Tip diameter          | φ 3mm max.   |
| Soldering time        | 3(+1, -0)s   |
| Time                  | 2 times      |

Note : Do not directly touch the products with the tip of the soldering iron in order to prevent the crack on the products due to the thermal shock.

**11.5 Solder Volume**

- Solder shall be used not to be exceeded the upper limits as shown below.
- Accordingly increasing the solder volume, the mechanical stress to Chip is also increased. Exceeding solder volume may cause the failure of mechanical or electrical performance.

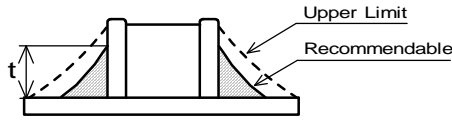

$1/3T \leq t \leq T$   
 T : thickness of product

**11.6 Product's location**

The following shall be considered when designing and laying out P.C.B.'s.

- (1) P.C.B. shall be designed so that products are not subject to the mechanical stress due to warping the board.

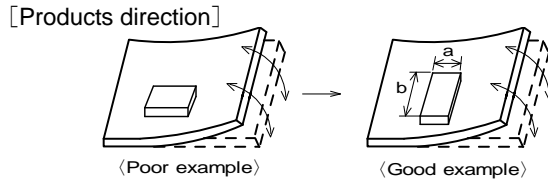

Products shall be located in the sideways direction (Length:  $a < b$ ) to the mechanical stress.

- (2) Products location on P.C.B. separation

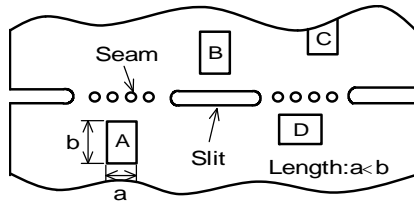

Products (A, B, C, D) shall be located carefully so that products are not subject to the mechanical stress due to warping the board. Because they may be subjected the mechanical stress in order of  $A \cdot C \cdot B \cong D$ .

**11.7 Cleaning Conditions**

Products shall be cleaned on the following conditions.

- (1) Cleaning temperature shall be limited to 60°C max. (40°C max for IPA.)
- (2) Ultrasonic cleaning shall comply with the following conditions with avoiding the resonance phenomenon at the mounted products and P.C.B.  
 Power : 20 W / l max.    Frequency : 28kHz to 40kHz    Time : 5 min max.
- (3) Cleaner
  1. Alcohol type cleaner  
Isopropyl alcohol (IPA)
  2. Aqueous agent  
PINE ALPHA ST-100S
- (4) There shall be no residual flux and residual cleaner after cleaning. In the case of using aqueous agent, products shall be dried completely after rinse with de-ionized water in order to remove the cleaner.
- (5) Other cleaning    Please contact us.

**11.8 Resin coating**

The inductance value may change and/or it may affect on the product's performance due to high cure-stress of resin to be used for coating/molding products. So please pay your careful attention when you select resin.  
 In prior to use, please make the reliability evaluation with the product mounted in your application set.

**11.9 Caution for use**

There is possibility that the inductance value change due to magnetism. Don't use a magnet or a pair of tweezers with magnetism when chip coil are handled. (The tip of the tweezers should be molded with resin or pottery.)

**11.10 Magnetic Saturation**

When the excessive current over rated current is applied, the inductance value may change due to magnetism.

### 11.11 Handling of a substrate

After mounting products on a substrate, do not apply any stress to the product caused by bending or twisting to the substrate when cropping the substrate, inserting and removing a connector from the substrate or tightening screw to the substrate.

Excessive mechanical stress may cause cracking in the product.

Bending

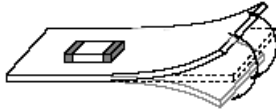

Twisting

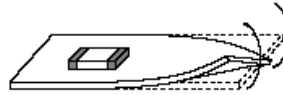

### 11.12 Storage and Handling Requirements

#### (1) Storage period

Use the products within 6 months after delivered.  
Solderability should be checked if this period is exceeded.

#### (2) Storage conditions

- Products should be stored in the warehouse on the following conditions.

Temperature : -10°C to 40°C

Humidity : 15% to 85% relative humidity No rapid change on temperature and humidity

Don't keep products in corrosive gases such as sulfur, chlorine gas or acid, or it may cause oxidization of electrode, resulting in poor solderability.

- Products should be stored on the palette for the prevention of the influence from humidity, dust and so on.
- Products should be stored in the warehouse without heat shock, vibration, direct sunlight and so on.
- Products should be stored under the airtight packaged condition.

#### (3) Handling Condition



Care should be taken when transporting or handling product to avoid excessive vibration or mechanical shock.

## 12. Note

- (1) Please make sure that your product has been evaluated in view of your specifications with our product being mounted to your product.
- (2) You are requested not to use our product deviating from the reference specifications.
- (3) The contents of this reference specification are subject to change without advance notice.  
Please approve our product specifications or transact the approval sheet for product specifications before ordering.

## Looking for pricing, stock, or lifecycle information?

Click below to explore more details on WIN SOURCE:

-  [View LQG21C220N00T1 on WIN SOURCE](#)
-  [Murata Electronics North America Information](#)

## Optimize Your Supply Chain with WIN SOURCE Solutions

-  Global Sourcing Solution
-  Obsolete Management
-  Cost Control Management
-  Shortage Management
-  Alternative Solution
-  Excess Inventory Management