



**THE DATASHEET OF
LT1121ACS8-3.3#TRPBF**



FEATURES

- 0.4V Dropout Voltage
- 150mA Output Current
- 30 μ A Quiescent Current
- No Protection Diodes Needed
- Adjustable Output from 3.75V to 30V
- 3.3V and 5V Fixed Output Voltages
- Controlled Quiescent Current in Dropout
- Shutdown
- 16 μ A Quiescent Current in Shutdown
- Stable with 0.33 μ F Output Capacitor
- Reverse Battery Protection
- No Reverse Current with Input Low
- Thermal Limiting
- Available in the 8-Lead SO, 8-Lead PDIP, 3-Lead SOT-23 and 3-Lead TO-92 Packages

APPLICATIONS

- Low Current Regulator
- Regulator for Battery-Powered Systems
- Post Regulator for Switching Supplies

DESCRIPTION

The LT[®]1121/LT1121-3.3/LT1121-5 are micropower low dropout regulators with shutdown. These devices are capable of supplying 150mA of output current with a dropout voltage of 0.4V. Designed for use in battery-powered systems, the low quiescent current, 30 μ A operating and 16 μ A in shutdown, makes them an ideal choice. The quiescent current is well-controlled; it does not rise in dropout as it does with many other low dropout PNP regulators.

Other features of the LT1121/LT1121-3.3/LT1121-5 include the ability to operate with very small output capacitors. They are stable with only 0.33 μ F on the output while most older devices require between 1 μ F and 100 μ F for stability. Small ceramic capacitors can be used, enhancing manufacturability. Also the input may be connected to ground or a reverse voltage without reverse current flow from output to input. This makes the LT1121 series ideal for backup power situations where the output is held high and the input is at ground or reversed. Under these conditions only 16 μ A will flow from the output pin to ground.

LT, LT, LTC, LTM, Linear Technology and the Linear logo are registered trademarks of Linear Technology Corporation. All other trademarks are the property of their respective owners.

TYPICAL APPLICATION

5V Battery-Powered Supply with Shutdown



V _{SHDN} (PIN 5)	OUTPUT
<0.25	OFF
>2.8	ON
NC	ON

LT1121 • TA01

Dropout Voltage

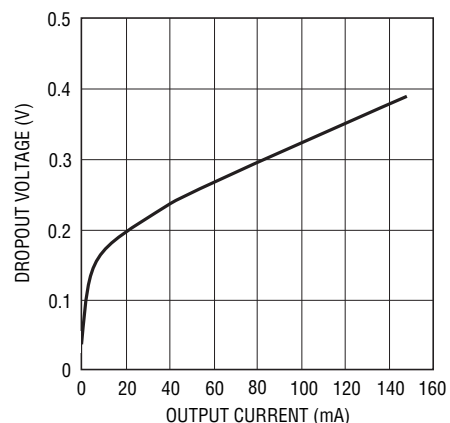

LT1121 • TA02

LT1121/LT1121-3.3/LT1121-5

ABSOLUTE MAXIMUM RATINGS

(Note 1)

Input Voltage	
LT1121	± 30V
LT1121HV	+36V, -30V
Output Pin Reverse Current	10mA
Adjust Pin Current	10mA
Shutdown Pin Input Voltage (Note 2)	6.5V, -0.6V
Shutdown Pin Input Current (Note 2)	20mA

Output Short-Circuit Duration	Indefinite
Operating Junction Temperature Range (Note 3)	
LT1121C-X	0°C to 125°C
LT1121I-X	-40°C to 125°C
Storage Temperature Range	-65°C to 150°C
Lead Temperature (Soldering, 10 sec)	300°C

PIN CONFIGURATION



ORDER INFORMATION

LEAD FREE FINISH	TAPE AND REEL	PART MARKING	PACKAGE DESCRIPTION	TEMPERATURE RANGE
LT1121CN8#PBF	LT1121CN8#TRPBF	LT1121CN8	8-Lead Plastic PDIP	0°C to 125°C
LT1121CN8-3.3#PBF	LT1121CN8-3.3#TRPBF	LT1121CN8-3.3	8-Lead Plastic PDIP	0°C to 125°C
LT1121CN8-5#PBF	LT1121CN8-5#TRPBF	LT1121CN8-5	8-Lead Plastic PDIP	0°C to 125°C
LT1121IN8#PBF	LT1121IN8#TRPBF	LT1121IN8	8-Lead Plastic PDIP	-40°C to 125°C
LT1121IN8-3.3#PBF	LT1121IN8-3.3#TRPBF	LT1121IN8-3.3	8-Lead Plastic PDIP	-40°C to 125°C
LT1121IN8-5#PBF	LT1121IN8-5#TRPBF	LT1121IN8-5	8-Lead Plastic PDIP	-40°C to 125°C
LT1121CS8#PBF	LT1121CS8#TRPBF	1121	8-Lead Plastic S0	0°C to 125°C
LT1121CS8-3.3#PBF	LT1121CS8-3.3#TRPBF	11213	8-Lead Plastic S0	0°C to 125°C
LT1121CS8-5#PBF	LT1121CS8-5#TRPBF	11215	8-Lead Plastic S0	0°C to 125°C
LT1121HVC8#PBF	LT1121HVC8#TRPBF	1121HV	8-Lead Plastic S0	-40°C to 125°C
LT1121IS8#PBF	LT1121IS8#TRPBF	1121I	8-Lead Plastic S0	-40°C to 125°C
LT1121IS8-3.3#PBF	LT1121IS8-3.3#TRPBF	12113	8-Lead Plastic S0	-40°C to 125°C
LT1121IS8-5#PBF	LT1121IS8-5#TRPBF	12115	8-Lead Plastic S0	-40°C to 125°C
LT1121HVIS8#PBF	LT1121HVIS8#TRPBF	121HVI	8-Lead Plastic S0	-40°C to 125°C
LT1121ACS8#PBF	LT1121ACS8#TRPBF	1121A	8-Lead Plastic S0	0°C to 125°C
LT1121ACS8-3.3#PBF	LT1121ACS8-3.3#TRPBF	1121A3	8-Lead Plastic S0	0°C to 125°C
LT1121ACS8-5#PBF	LT1121ACS8-5#TRPBF	1121A5	8-Lead Plastic S0	0°C to 125°C

1121fg

ORDER INFORMATION

LEAD FREE FINISH	TAPE AND REEL	PART MARKING	PACKAGE DESCRIPTION	TEMPERATURE RANGE
LT1121AHVCS8#PBF	LT1121AHVCS8#TRPBF	121AHV	8-Lead Plastic S0	0°C to 125°C
LT1121AIS8#PBF	LT1121AIS8#TRPBF	121AI	8-Lead Plastic S0	-40°C to 125°C
LT1121AIS8-3.3#PBF	LT1121AIS8-3.3#TRPBF	121AI3	8-Lead Plastic S0	-40°C to 125°C
LT1121AIS8-5#PBF	LT1121AIS8-5#TRPBF	121AI5	8-Lead Plastic S0	-40°C to 125°C
LT1121AHVIS8#PBF	LT1121AHVIS8#TRPBF	21AHVI	8-Lead Plastic S0	-40°C to 125°C
LT1121CST-3.3#PBF	LT1121CST-3.3#TRPBF	11213	3-Lead Plastic SOT-223	0°C to 125°C
LT1121IST-3.3#PBF	LT1121IST-3.3#TRPBF	121I3	3-Lead Plastic SOT-223	-40°C to 125°C
LT1121CST-5#PBF	LT1121CST-5#TRPBF	11215	3-Lead Plastic SOT-223	0°C to 125°C
LT1121IST-5#PBF	LT1121IST-5#TRPBF	1121I5	3-Lead Plastic SOT-223	-40°C to 125°C
LT1121CZ3-3#PBF	LT1121CZ3-3#TRPBF	LT1121CZ3-3	3-Lead Plastic TO-92	0°C to 125°C
LT1121IZ3-3#PBF	LT1121IZ3-3#TRPBF	LT1121IZ3-3	3-Lead Plastic TO-92	-40°C to 125°C
LT1121CZ-5#PBF	LT1121CZ-5#TRPBF	LT1121CZ-5	3-Lead Plastic TO-92	0°C to 125°C
LT1121IZ-5#PBF	LT1121IZ-5#TRPBF	LT1121IZ-5	3-Lead Plastic TO-92	-40°C to 125°C

Consult LTC Marketing for parts specified with wider operating temperature ranges. *The temperature grade is identified by a label on the shipping container.

Consult LTC Marketing for information on nonstandard lead based finish parts.

For more information on lead free part marking, go to: <http://www.linear.com/leadfree/>

For more information on tape and reel specifications, go to: <http://www.linear.com/tapeandreeel/>

ELECTRICAL CHARACTERISTICS

The ● denotes the specifications which apply over the full operating temperature range, otherwise specifications are at $T_A = 25^\circ\text{C}$.

PARAMETER	CONDITIONS	MIN	TYP	MAX	UNITS
Regulated Output Voltage (Note 4)	LT1121-3.3 $V_{IN} = 3.8\text{V}$, $I_{OUT} = 1\text{mA}$, $T_J = 25^\circ\text{C}$ $4.3\text{V} < V_{IN} < 20\text{V}$, $1\text{mA} < I_{OUT} < 150\text{mA}$	● 3.25 3.2	3.3 3.3	3.35 3.4	V V
	LT1121-5 $V_{IN} = 5.5\text{V}$, $I_{OUT} = 1\text{mA}$, $T_J = 25^\circ\text{C}$ $6\text{V} < V_{IN} < 20\text{V}$, $1\text{mA} < I_{OUT} < 150\text{mA}$	● 4.925 4.85	5 5	5.075 5.15	V V
	LT1121 (Note 5) $V_{IN} = 4.3\text{V}$, $I_{OUT} = 1\text{mA}$, $T_J = 25^\circ\text{C}$ $4.8\text{V} < V_{IN} < 20\text{V}$, $1\text{mA} < I_{OUT} < 150\text{mA}$	● 3.695 3.64	3.75 3.75	3.805 3.86	V V
Line Regulation	LT1121-3.3 $\Delta V_{IN} = 4.8\text{V TO } 20\text{V}$, $I_{OUT} = 1\text{mA}$	●	1.5	10	mV
	LT1121-5 $\Delta V_{IN} = 5.5\text{V TO } 20\text{V}$, $I_{OUT} = 1\text{mA}$	●	1.5	10	mV
	LT1121 (Note 5) $\Delta V_{IN} = 4.3\text{V TO } 20\text{V}$, $I_{OUT} = 1\text{mA}$	●	1.5	10	mV
Load Regulation	LT1121-3.3 $\Delta I_{LOAD} = 1\text{mA to } 150\text{mA}$, $T_J = 25^\circ\text{C}$ $\Delta I_{LOAD} = 1\text{mA to } 150\text{mA}$	●	-12 -20	-25 -40	mV mV
	LT1121-5 $\Delta I_{LOAD} = 1\text{mA to } 150\text{mA}$, $T_J = 25^\circ\text{C}$ $\Delta I_{LOAD} = 1\text{mA to } 150\text{mA}$	●	-17 -28	-35 -50	mV mV
	LT1121 (Note 5) $\Delta I_{LOAD} = 1\text{mA to } 150\text{mA}$, $T_J = 25^\circ\text{C}$ $\Delta I_{LOAD} = 1\text{mA to } 150\text{mA}$	●	-12 -18	-25 -40	mV mV
	Dropout Voltage (Note 6)	$I_{LOAD} = 1\text{mA}$, $T_J = 25^\circ\text{C}$ $I_{LOAD} = 1\text{mA}$	●	0.13	0.16 0.25
	$I_{LOAD} = 50\text{mA}$, $T_J = 25^\circ\text{C}$ $I_{LOAD} = 50\text{mA}$	●	0.3	0.35 0.5	V V
	$I_{LOAD} = 100\text{mA}$, $T_J = 25^\circ\text{C}$ $I_{LOAD} = 100\text{mA}$	●	0.37	0.45 0.6	V V
	$I_{LOAD} = 150\text{mA}$, $T_J = 25^\circ\text{C}$ $I_{LOAD} = 150\text{mA}$	●	0.42	0.55 0.7	V V

ELECTRICAL CHARACTERISTICS

The ● denotes the specifications which apply over the full operating temperature range, otherwise specifications are at $T_A = 25^\circ\text{C}$.

PARAMETER	CONDITIONS	MIN	TYP	MAX	UNITS
Ground Pin Current (Note 7)	$I_{\text{LOAD}} = 0\text{mA}$	●	30	50	μA
	$I_{\text{LOAD}} = 1\text{mA}$	●	90	120	μA
	$I_{\text{LOAD}} = 10\text{mA}$	●	350	500	μA
	$I_{\text{LOAD}} = 50\text{mA}$	●	1.5	2.5	mA
	$I_{\text{LOAD}} = 100\text{mA}$	●	4	7	mA
	$I_{\text{LOAD}} = 150\text{mA}$	●	7	14	mA
Adjust Pin Bias Current (Notes 5, 8)	$T_J = 25^\circ\text{C}$		150	300	nA
Shutdown Threshold	$V_{\text{OUT}} = \text{Off to On}$	●	1.2	2.8	V
	$V_{\text{OUT}} = \text{On to Off}$	●	0.25	0.75	V
Shutdown Pin Current (Note 9)	$V_{\text{SHDN}} = 0\text{V}$	●	6	10	μA
Quiescent Current in Shutdown (Note 10)	$V_{\text{IN}} = 6\text{V}, V_{\text{SHDN}} = 0\text{V}$	●	16	22	μA
Ripple Rejection	$V_{\text{IN}} - V_{\text{OUT}} = 1\text{V (Avg)}, V_{\text{RIPPLE}} = 0.5\text{V}_{\text{P-P}}, f_{\text{RIPPLE}} = 120\text{Hz}, I_{\text{LOAD}} = 0.1\text{A}$		50	58	dB
Current Limit	$V_{\text{IN}} - V_{\text{OUT}} = 7\text{V}, T_J = 25^\circ\text{C}$		200	500	mA
Input Reverse Leakage Current	$V_{\text{IN}} = -20\text{V}, V_{\text{OUT}} = 0\text{V}$	●		1	mA
Reverse Output Current (Note 11)	LT1121-3.3 $V_{\text{OUT}} = 3.3\text{V}, V_{\text{IN}} = 0\text{V}$		16	25	μA
	LT1121-5 $V_{\text{OUT}} = 5\text{V}, V_{\text{IN}} = 0\text{V}$		16	25	μA
	LT1121 (Note 5) $V_{\text{OUT}} = 3.8\text{V}, V_{\text{IN}} = 0\text{V}$		16	25	μA

Note 1: Stresses beyond those listed under Absolute Maximum Ratings may cause permanent damage to the device. Exposure to any Absolute Maximum Rating condition for extended periods may affect device reliability and lifetime.

Note 2: The shutdown pin input voltage rating is required for a low impedance source. Internal protection devices connected to the shutdown pin will turn on and clamp the pin to approximately 7V or -0.6V . This range allows the use of 5V logic devices to drive the pin directly. For high impedance sources or logic running on supply voltages greater than 5.5V, the maximum current driven into the shutdown pin must be limited to less than 20mA.

Note 3: For junction temperatures greater than 110°C , a minimum load of 1mA is recommended. For $T_J > 110^\circ\text{C}$ and $I_{\text{OUT}} < 1\text{mA}$, output voltage may increase by 1%.

Note 4: Operating conditions are limited by maximum junction temperature. The regulated output voltage specification will not apply for all possible combinations of input voltage and output current. When operating at maximum input voltage, the output current range must be limited. When operating at maximum output current the input voltage range must be limited.

Note 5: The LT1121 (adjustable version) is tested and specified with the adjust pin connected to the output pin.

Note 6: Dropout voltage is the minimum input/output voltage required to maintain regulation at the specified output current. In dropout the output voltage will be equal to: $(V_{\text{IN}} - V_{\text{DROPOUT}})$.

Note 7: Ground pin current is tested with $V_{\text{IN}} = V_{\text{OUT}}$ (nominal) and a current source load. This means that the device is tested while operating in its dropout region. This is the worst case ground pin current. The ground pin current will decrease slightly at higher input voltages.

Note 8: Adjust pin bias current flows into the adjust pin.

Note 9: Shutdown pin current at $V_{\text{SHDN}} = 0\text{V}$ flows out of the shutdown pin.

Note 10: Quiescent current in shutdown is equal to the sum total of the shutdown pin current ($6\mu\text{A}$) and the ground pin current ($9\mu\text{A}$).

Note 11: Reverse output current is tested with the input pin grounded and the output pin forced to the rated output voltage. This current flows into the output pin and out of the ground pin.

TYPICAL PERFORMANCE CHARACTERISTICS

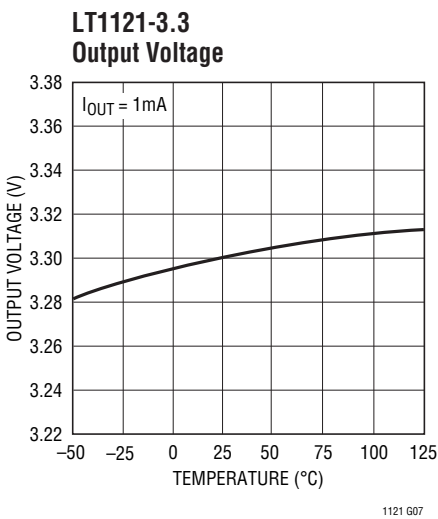

TYPICAL PERFORMANCE CHARACTERISTICS

LT1121-3.3
Ground Pin Current



1121 G10

LT1121-5
Ground Pin Current



1121 G11

LT1121
Ground Pin Current



1121 G12

LT1121-3.3
Ground Pin Current



1121 G13

LT1121-5
Ground Pin Current



1121 G14

LT1121
Ground Pin Current



1121 G15

Ground Pin Current



1121 G16

Shutdown Pin Threshold
(On-to-Off)

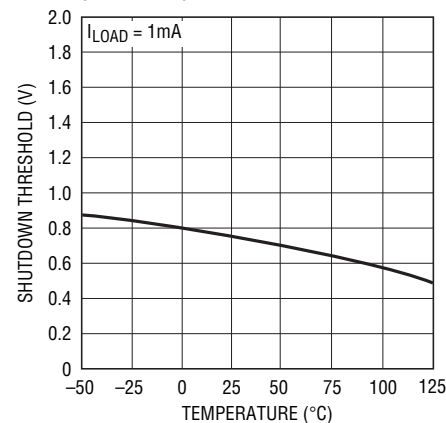

1121 G17

Shutdown Pin Threshold
(Off-to-On)



1121 G18

TYPICAL PERFORMANCE CHARACTERISTICS



1121 G19

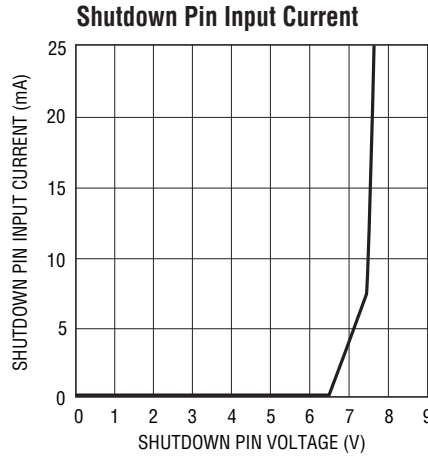

1121 G20



1121 G21



1121 G22



1121 G23



1121 G24

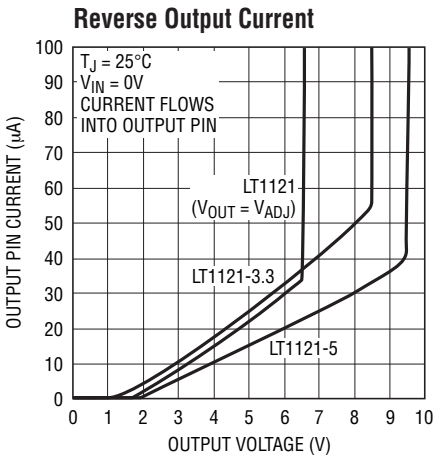

1121 G25

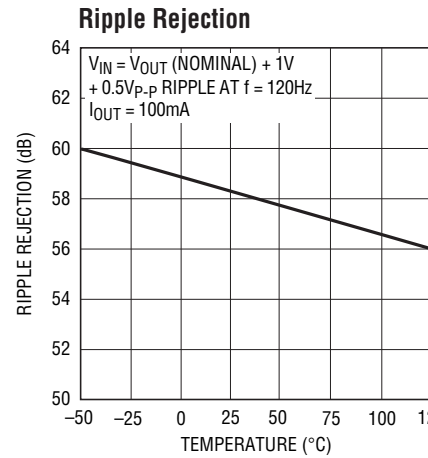

1121 G26

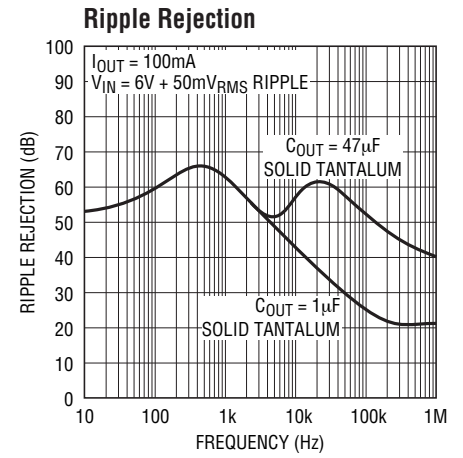

1121 G27

TYPICAL PERFORMANCE CHARACTERISTICS



PIN FUNCTIONS

Input Pin: Power is supplied to the device through the input pin. The input pin should be bypassed to ground if the device is more than six inches away from the main input filter capacitor. In general the output impedance of a battery rises with frequency so it is usually advisable to include a bypass capacitor in battery-powered circuits. A bypass capacitor in the range of 0.1 μF to 1 μF is sufficient. The LT1121 is designed to withstand reverse voltages on the input pin with respect to both ground and the output pin. In the case of a reversed input, which can happen if a battery is plugged in backwards, the LT1121 will act as if there is a diode in series with its input. There will be no reverse current flow into the LT1121 and no reverse voltage will appear at the load. The device will protect both itself and the load.

Output Pin: The output pin supplies power to the load. An output capacitor is required to prevent oscillations. See the Applications Information section for recommended value of output capacitance and information on reverse output characteristics.

Shutdown Pin: This pin is used to put the device into shutdown. In shutdown the output of the device is turned

off. This pin is active low. The device will be shut down if the shutdown pin is pulled low. The shutdown pin current with the pin pulled to ground will be 6 μA . The shutdown pin is internally clamped to 7V and -0.6V (one V_{BE}). This allows the shutdown pin to be driven directly by 5V logic or by open collector logic with a pull-up resistor. The pull-up resistor is only required to supply the leakage current of the open collector gate, normally several microamperes. Pull-up current must be limited to a maximum of 20mA. A curve of shutdown pin input current as a function of voltage appears in the Typical Performance Characteristics. If the shutdown pin is not used it can be left open circuit. The device will be active, output on, if the shutdown pin is not connected.

Adjust Pin: For the adjustable LT1121, the adjust pin is the input to the error amplifier. This pin is internally clamped to 6V and -0.6V (one V_{BE}). It has a bias current of 150nA which flows into the pin. See Bias Current curve in the Typical Performance Characteristics. The adjust pin reference voltage is 3.75V referenced to ground. The output voltage range that can be produced by this device is 3.75V to 30V.

APPLICATIONS INFORMATION

The LT1121 is a micropower low dropout regulator with shutdown, capable of supplying up to 150mA of output current at a dropout voltage of 0.4V. The device operates with very low quiescent current (30µA). In shutdown the quiescent current drops to only 16µA. In addition to the low quiescent current the LT1121 incorporates several protection features which make it ideal for use in battery-powered systems. The device is protected against both reverse input voltages and reverse output voltages. In battery backup applications where the output can be held up by a backup battery when the input is pulled to ground, the LT1121 acts like it has a diode in series with its output and prevents reverse current flow.

Adjustable Operation

The adjustable version of the LT1121 has an output voltage range of 3.75V to 30V. The output voltage is set by the ratio of two external resistors as shown in Figure 1. The device servos the output voltage to maintain the voltage at the adjust pin at 3.75V. The current in R1 is then equal to 3.75V/R1. The current in R2 is equal to the sum of the current in R1 and the adjust pin bias current. The adjust pin bias current, 150nA at 25°C, flows through R2 into the adjust pin. The output voltage can be calculated according to the formula in Figure 1. The value of R1 should be less than 400k to minimize errors in the output voltage caused by the adjust pin bias current. Note that in shutdown the output is turned off and the divider current will be zero. Curves of Adjust Pin Voltage vs Temperature and Adjust Pin Bias Current vs Temperature appear in the Typical Performance Characteristics. The reference voltage at the adjust pin has a slight positive temperature coefficient of



$$V_{OUT} = 3.75V \left(1 + \frac{R2}{R1} \right) + (I_{ADJ} \cdot R2)$$

$$V_{ADJ} = 3.75V$$

$$I_{ADJ} = 150nA \text{ AT } 25^{\circ}C$$

$$OUTPUT \text{ RANGE} = 3.75V \text{ TO } 30V$$

Figure 1. Adjustable Operation

approximately 15ppm/°C. The adjust pin bias current has a negative temperature coefficient. These effects are small and will tend to cancel each other.

The adjustable device is specified with the adjust pin tied to the output pin. This sets the output voltage to 3.75V. Specifications for output voltage greater than 3.75V will be proportional to the ratio of the desired output voltage to 3.75V ($V_{OUT}/3.75V$). For example: load regulation for an output current change of 1mA to 150mA is -12mV typical at $V_{OUT} = 3.75V$. At $V_{OUT} = 12V$, load regulation would be:

$$\left(\frac{12V}{3.75V} \right) \cdot (-12mV) = (-38mV)$$

Thermal Considerations

Power handling capability will be limited by maximum rated junction temperature (125°C). Power dissipated by the device will be made up of two components:

1. Output current multiplied by the input/output voltage differential: $I_{OUT} \cdot (V_{IN} - V_{OUT})$, and
2. Ground pin current multiplied by the input voltage: $I_{GND} \cdot V_{IN}$.

The ground pin current can be found by examining the Ground Pin Current curves in the Typical Performance Characteristics. Power dissipation will be equal to the sum of the two components listed above.

The LT1121 series regulators have internal thermal limiting designed to protect the device during overload conditions. For continuous normal load conditions the maximum junction temperature rating of 125°C must not be exceeded. It is important to give careful consideration to all sources of thermal resistance from junction to ambient. Additional heat sources mounted nearby must also be considered.

Heat sinking, for surface mount devices, is accomplished by using the heat spreading capabilities of the PC board and its copper traces. Copper board stiffeners and plated through holes can also be used to spread the heat generated by power devices. Tables 1 through 5 list thermal resistances for each package. Measured values of thermal resistance for several different board sizes and copper areas are listed for each package. All measurements were taken in still air, on 3/32" FR-4 board with 1 oz copper. All

APPLICATIONS INFORMATION

NC leads were connected to the ground plane.

Table 1. N8 Package*

COPPER AREA		BOARD AREA	THERMAL RESISTANCE JUNCTION TO AMBIENT
TOPSIDE	BACKSIDE		
2500 sq mm	2500 sq mm	2500 sq mm	80°C/W
1000 sq mm	2500 sq mm	2500 sq mm	80°C/W
225 sq mm	2500 sq mm	2500 sq mm	85°C/W
1000 sq mm	1000 sq mm	1000 sq mm	91°C/W

* Device is mounted on topside. Leads are through hole and are soldered to both sides of board.

Table 2. S8 Package

COPPER AREA		BOARD AREA	THERMAL RESISTANCE JUNCTION TO AMBIENT
TOPSIDE*	BACKSIDE		
2500 sq mm	2500 sq mm	2500 sq mm	120°C/W
1000 sq mm	2500 sq mm	2500 sq mm	120°C/W
225 sq mm	2500 sq mm	2500 sq mm	125°C/W
100 sq mm	1000 sq mm	1000 sq mm	131°C/W

* Device is mounted on topside.

Table 3. AS8 Package*

COPPER AREA		BOARD AREA	THERMAL RESISTANCE JUNCTION TO AMBIENT
TOPSIDE**	BACKSIDE		
2500 sq mm	2500 sq mm	2500 sq mm	60°C/W
1000 sq mm	2500 sq mm	2500 sq mm	60°C/W
225 sq mm	2500 sq mm	2500 sq mm	68°C/W
100 sq mm	2500 sq mm	2500 sq mm	74°C/W

* Pins 3, 6 and 7 are ground.

** Device is mounted on topside.

**Table 4. SOT-223 Package
(Thermal Resistance Junction-to-Tab 20°C/W)**

COPPER AREA		BOARD AREA	THERMAL RESISTANCE JUNCTION TO AMBIENT
TOPSIDE*	BACKSIDE		
2500 sq mm	2500 sq mm	2500 sq mm	50°C/W
1000 sq mm	2500 sq mm	2500 sq mm	50°C/W
225 sq mm	2500 sq mm	2500 sq mm	58°C/W
100 sq mm	2500 sq mm	2500 sq mm	64°C/W
1000 sq mm	2500 sq mm	1000 sq mm	57°C/W
1000 sq mm	0	1000 sq mm	60°C/W

* Tab of device attached to topside copper.

Table 5. TO-92 Package THERMAL RESISTANCE

Package alone	220°C/W
Package soldered into PC board with plated through holes only	175°C/W
Package soldered into PC board with 1/4 sq. inch of copper trace per lead	145°C/W
Package soldered into PC board with plated through holes in board, no extra copper trace, and a clip-on type heat sink: Thermalloy type 2224B	160°C/W
Aavid type 5754	135°C/W

Calculating Junction Temperature

Example: given an output voltage of 3.3V, an input voltage range of 4.5V to 7V, an output current range of 0mA to 100mA, and a maximum ambient temperature of 50°C, what will the maximum junction temperature be?

Power dissipated by the device will be equal to:

$$I_{OUT\ MAX} \cdot (V_{IN\ MAX} - V_{OUT}) + (I_{GND} \cdot V_{IN})$$

where, $I_{OUT\ MAX} = 100\text{mA}$

$$V_{IN\ MAX} = 7\text{V}$$

$$I_{GND} \text{ at } (I_{OUT} = 100\text{mA}, V_{IN} = 7\text{V}) = 5\text{mA}$$

$$\text{so, } P = 100\text{mA} \cdot (7\text{V} - 3.3\text{V}) + (5\text{mA} \cdot 7\text{V}) = 0.405\text{W}$$

If we use an SOT-223 package, then the thermal resistance will be in the range of 50°C/W to 65°C/W depending on copper area. So the junction temperature rise above ambient will be less than or equal to:

$$0.405\text{W} \cdot 60^\circ\text{C/W} = 24^\circ\text{C}$$

The maximum junction temperature will then be equal to the maximum junction temperature rise above ambient plus the maximum ambient temperature or:

$$T_{JMAX} = 50^\circ\text{C} + 24^\circ\text{C} = 74^\circ\text{C}$$

Output Capacitance and Transient Performance

The LT1121 is designed to be stable with a wide range of output capacitors. The minimum recommended value is 1µF with an ESR of 3Ω or less. For applications where space is very limited, capacitors as low as 0.33µF can be used if combined with a small series resistor. Assuming that the ESR of the capacitor is low (ceramic) the suggested series

APPLICATIONS INFORMATION

resistor is shown in Table 6. The LT1121 is a micropower device and output transient response will be a function of output capacitance. See the Transient Response curves in the Typical Performance Characteristics. Larger values of output capacitance will decrease the peak deviations and provide improved output transient response. Bypass capacitors, used to decouple individual components powered by the LT1121, will increase the effective value of the output capacitor.

Table 6. Suggested Series Resistor Values

OUTPUT CAPACITANCE	SUGGESTED SERIES RESISTOR
0.33 μ F	2 Ω
0.47 μ F	1 Ω
0.68 μ F	1 Ω
>1 μ F	None Needed

Protection Features

The LT1121 incorporates several protection features which make it ideal for use in battery-powered circuits. In addition to the normal protection features associated with monolithic regulators, such as current limiting and thermal limiting, the device is protected against reverse input voltages, reverse output voltages, and reverse voltages from output to input.

Current limit protection and thermal overload protection are intended to protect the device against current overload conditions at the output of the device. For normal operation, the junction temperature should not exceed 125°C.

The input of the device will withstand reverse voltages of 30V. Current flow into the device will be limited to less than 1mA (typically less than 100 μ A) and no negative voltage will appear at the output. The device will protect both itself and the load. This provides protection against batteries that can be plugged in backwards.

For fixed voltage versions of the device, the output can be pulled below ground without damaging the device. If the input is open circuit or grounded the output can be pulled below ground by 20V. The output will act like an open circuit, no current will flow out of the pin. If the input is powered by a voltage source, the output will source the

short-circuit current of the device and will protect itself by thermal limiting. For the adjustable version of the device, the output pin is internally clamped at one diode drop below ground. Reverse current for the adjustable device must be limited to 5mA.

In circuits where a backup battery is required, several different input/output conditions can occur. The output voltage may be held up while the input is either pulled to ground, pulled to some intermediate voltage, or is left open circuit. Current flow back into the output will vary depending on the conditions. Many battery-powered circuits incorporate some form of power management. The following information will help optimize battery life. Table 7 summarizes the following information.

The reverse output current will follow the curve in Figure 2 when the input pin is pulled to ground. This current flows through the output pin to ground. The state of the shutdown pin will have no effect on output current when the input pin is pulled to ground.

In some applications it may be necessary to leave the input to the LT1121 unconnected when the output is held high. This can happen when the LT1121 is powered from a rectified AC source. If the AC source is removed, then the input of the LT1121 is effectively left floating. The reverse output current also follows the curve in Figure 2 if the input pin is left open. The state of the shutdown pin will have no effect on the reverse output current when the input pin is floating.



Figure 2. Reverse Output Current

APPLICATIONS INFORMATION

When the input of the LT1121 is forced to a voltage below its nominal output voltage and its output is held high, the reverse output current will still follow the curve in Figure 2. This condition can occur if the input of the LT1121 is connected to a discharged (low voltage) battery and the output is held up by either a backup battery or by a second regulator circuit. When the input pin is forced below the output pin or the output pin is pulled above the input pin, the input current will typically drop to less than 2 μ A (see Figure 3). The state of the shutdown pin will have no effect on the reverse output current when the output is pulled above the input.



Figure 3. Input Current

Table 7. Fault Conditions

INPUT PIN	SHDN PIN	OUTPUT PIN	
<V _{OUT} (Nominal)	Open (Hi)	Forced to V _{OUT} (Nominal)	Reverse Output Current ≈ 15 μ A (See Figure 2) Input Current ≈ 1 μ A (See Figure 3)
<V _{OUT} (Nominal)	Grounded	Forced to V _{OUT} (Nominal)	Reverse Output Current ≈ 15 μ A (See Figure 2) Input Current ≈ 1 μ A (See Figure 3)
Open	Open (Hi)	Forced to V _{OUT} (Nominal)	Reverse Output Current ≈ 15 μ A (See Figure 2)
Open	Grounded	Forced to V _{OUT} (Nominal)	Reverse Output Current ≈ 15 μ A (See Figure 2)
≤0.8V	Open (Hi)	≤0V	Output Current = 0
≤0.8V	Grounded	≤0V	Output Current = 0
>1.5V	Open (Hi)	≤0V	Output Current = Short-Circuit Current
-30V < V _{IN} < 30V	Grounded	≤0V	Output Current = 0

PACKAGE DESCRIPTION

Please refer to <http://www.linear.com/designtools/packaging/> for the most recent package drawings.

N Package 8-Lead PDIP (Narrow .300 Inch) (Reference LTC DWG # 05-08-1510 Rev I)



NOTE:

1. DIMENSIONS ARE $\frac{\text{INCHES}}{\text{MILLIMETERS}}$

*THESE DIMENSIONS DO NOT INCLUDE MOLD FLASH OR PROTRUSIONS.
MOLD FLASH OR PROTRUSIONS SHALL NOT EXCEED .010 INCH (0.254mm)

S8 Package 8-Lead Plastic Small Outline (Narrow .150 Inch) (Reference LTC DWG # 05-08-1610 Rev G)

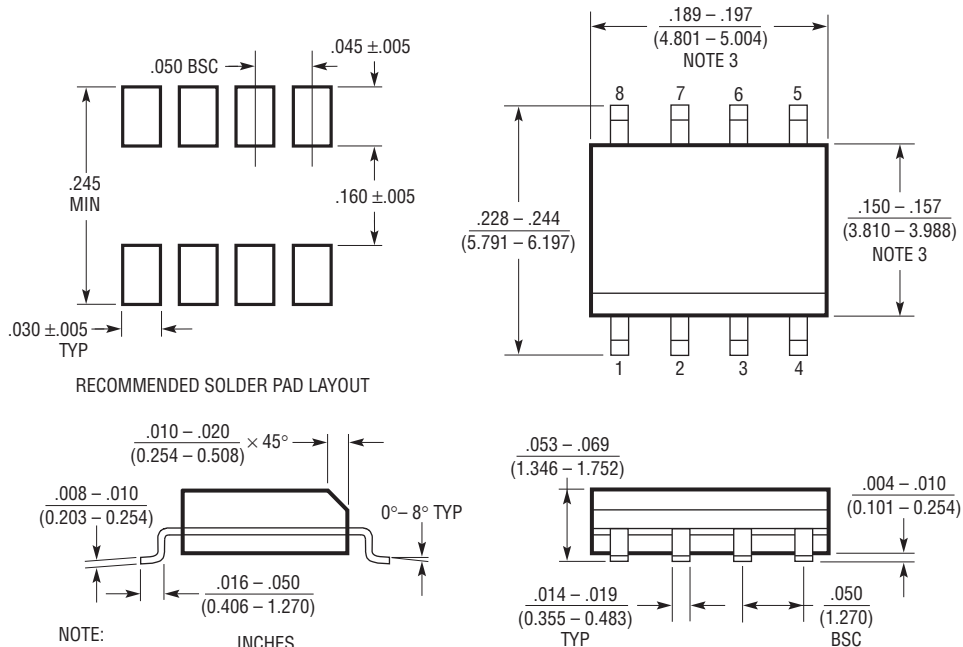

NOTE:

1. DIMENSIONS IN $\frac{\text{INCHES}}{\text{MILLIMETERS}}$

2. DRAWING NOT TO SCALE

3. THESE DIMENSIONS DO NOT INCLUDE MOLD FLASH OR PROTRUSIONS.
MOLD FLASH OR PROTRUSIONS SHALL NOT EXCEED .006" (0.15mm)

4. PIN 1 CAN BE BEVEL EDGE OR A DIMPLE

S08 REV G 0212

PACKAGE DESCRIPTION

Please refer to <http://www.linear.com/designtools/packaging/> for the most recent package drawings.

ST Package
3-Lead Plastic SOT-223
 (Reference LTC DWG # 05-08-1630)



Z Package
3-Lead Plastic TO-92 (Similar to TO-226)
 (Reference LTC DWG # 05-08-1410 Rev C)

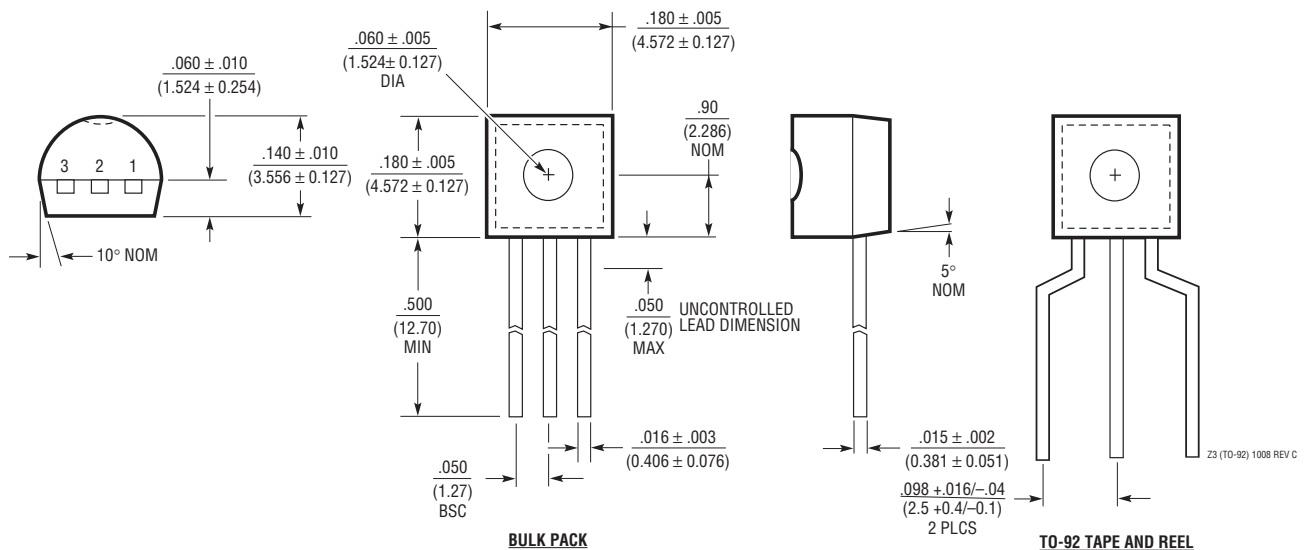

REFER TO TAPE AND REEL SECTION OF
 LTC DATA BOOK FOR ADDITIONAL INFORMATION

REVISION HISTORY (Revision history begins at Rev G)

REV	DATE	DESCRIPTION	PAGE NUMBER
G	05/12	Changed Order Information top marking for 8-lead SO 3.3V and 5V options, C-grade	2

LT1121/LT1121-3.3/LT1121-5

RELATED PARTS

PART NUMBER	DESCRIPTION	COMMENTS
LT1120	125mA Low Dropout Regulator with 20 μ A I _Q	Includes 2.5V Reference and Comparator
LT1129	700mA Micropower Low Dropout Regulator	50 μ A Quiescent Current
LT1175	500mA Negative Low Dropout Micropower Regulator	45 μ A I _Q , 0.26V Dropout Voltage, SOT-223 Package
LT1521	300mA Low Dropout Micropower Regulator with Shutdown	15 μ A, I _Q , Reverse Battery Protection
LT1529	3A Low Dropout Regulator with 50 μ A I _Q	500mV Dropout Voltage
LT1611	Inverting 1.4MHz Switching Regulator	5V to -5V at 150mA, Low Output Noise, SOT-23 Package
LT1613	1.4MHz Single-Cell Micropower DC/DC Converter	SOT-23 Package, Internally Compensated
LT1627	High Efficiency Synchronous Step-Down Switching Regulator	Burst Mode™ Operation, Monolithic, 100% Duty Cycle
LT1682	Doubler Charge Pump with Low Noise Linear Regulator	Low Output Noise: 60 μ V _{RMS} (100kHz BW)
LT1762 Series	150mA, Low Noise, LDO Micropower Regulator	25 μ A Quiescent Current, 20 μ V _{RMS} Noise
LT1763 Series	500mA, Low Noise, LDO Micropower Regulator	30 μ A Quiescent Current, 20 μ V _{RMS} Noise
LT1764 Series	3A Fast Transient Response LDO	300mV Dropout, 40 μ V _{RMS} Noise
LT1962 Series	300mA, Low Noise, LDO Micropower Regulator	30 μ A Quiescent Current, 20 μ V _{RMS} Noise
LT1963 Series	1.5A Fast Transient Response LDO	300mV Dropout, 40 μ V _{RMS} Noise

Burst Mode is a trademark of Linear Technology Corporation.

Looking for pricing, stock, or lifecycle information?

Click below to explore more details on WIN SOURCE:

 [View LT1121ACS8-3.3#TRPBF on WIN SOURCE](#)

 [Linear Technology](#) Information

Optimize Your Supply Chain with WIN SOURCE Solutions

-  Global Sourcing Solution
-  Obsolete Management
-  Cost Control Management
-  Shortage Management
-  Alternative Solution
-  Excess Inventory Management