



**THE DATASHEET OF  
LT1213CS8#TRPBF**



## FEATURES

- Slew Rate: 12V/ $\mu$ s Typ
- Gain-Bandwidth Product: 28MHz Typ
- Fast Settling to 0.01%
  - 2V Step to 200 $\mu$ V: 500ns Typ
  - 10V Step to 1mV: 1.1 $\mu$ s Typ
- Excellent DC Precision in All Packages
  - Input Offset Voltage: 275 $\mu$ V Max
  - Input Offset Voltage Drift: 6 $\mu$ V/ $^{\circ}$ C Max
  - Input Offset Current: 40nA Max
  - Input Bias Current: 200nA Max
  - Open-Loop Gain: 1200V/mV Min
- Single Supply Operation
  - Input Voltage Range Includes Ground
  - Output Swings to Ground While Sinking Current
- Low Input Noise Voltage: 10nV/ $\sqrt{\text{Hz}}$  Typ
- Low Input Noise Current: 0.2pA/ $\sqrt{\text{Hz}}$  Typ
- Specified at 3.3V, 5V and  $\pm$ 15V
- Large Output Drive Current: 30mA Min
- Low Supply Current per Amplifier: 3.5mA Max
- Dual in 8-Pin DIP and SO-8
- Quad in 14-Pin DIP and NARROW SO-16

**Note:** For applications requiring higher slew rate, see the LT1215/LT1216 data sheet. For lower power and lower slew rate, see the LT1211/LT1212 data sheet.

## DESCRIPTION

The LT<sup>®</sup>1213 is a dual, single supply precision op amp with a 28MHz gain-bandwidth product and a 12V/ $\mu$ s slew rate. The LT1214 is a quad version of the same amplifier. The DC precision of the LT1213/LT1214 eliminates trims in most systems while providing high frequency performance not usually found in single supply amplifiers.

The LT1213/LT1214 will operate on any supply greater than 2.5V and less than 36V total. These amplifiers are specified at single 3.3V, single 5V and  $\pm$ 15V supplies, and only require 2.7mA of quiescent supply current per amplifier. The inputs can be driven beyond the supplies without damage or phase reversal of the output. The minimum output drive is 30mA, ideal for driving low impedance loads.

## APPLICATIONS

- 2.5V Full-Scale 12-Bit Systems:  $V_{OS} \leq 0.45\text{LSB}$
- 10V Full-Scale 16-Bit Systems:  $V_{OS} \leq 1.8\text{LSB}$
- Active Filters
- Photodiode Amplifiers
- DAC Current-to-Voltage Amplifiers
- Battery-Powered Systems

 LTC and LT are registered trademarks of Linear Technology Corporation.

## TYPICAL APPLICATION

Single Supply 3-Pole 1MHz Butterworth Filter

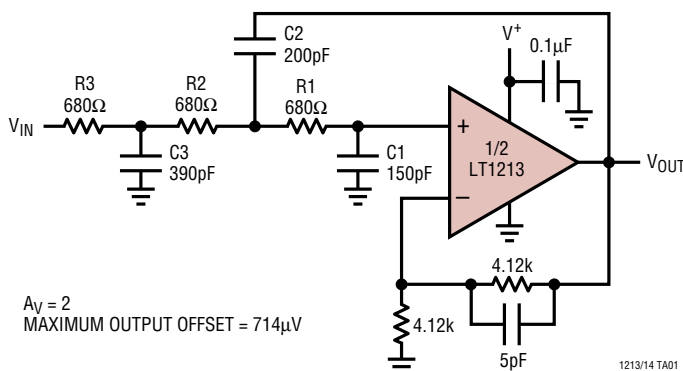

Frequency Response

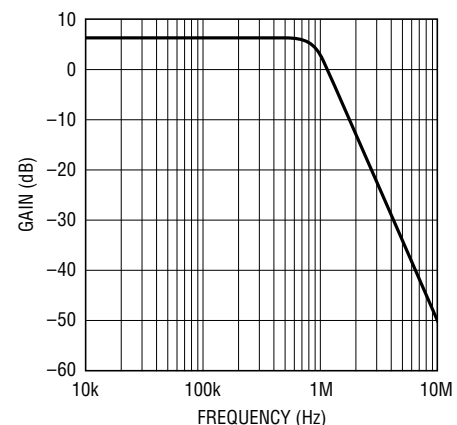

# LT1213/LT1214

## ABSOLUTE MAXIMUM RATINGS (Note 1)

|   |                |  |                |
|---|----------------|--|----------------|
| Total Supply Voltage ( $V^+$ to $V^-$ ) ..... | 36V            | Storage Temperature Range .....                | -65°C to 150°C |
| Input Current .....                           | ±15mA          | Junction Temperature (Note 3)                  |                |
| Output Short-Circuit Duration (Note 2) .....  | Continuous     | Plastic Package (N8, S8, N, S) .....           | 150°C          |
| Operating Temperature Range                   |                | Ceramic Package (J8) ( <b>OBSOLETE</b> ) ..... | 175°C          |
| LT1213C/LT1214C .....                         | -40°C to 85°C  | Lead Temperature (Soldering, 10 sec) .....     | 300°C          |
| LT1213M ( <b>OBSOLETE</b> ) .....             | -55°C to 125°C |  |                |

## PACKAGE/ORDER INFORMATION

|  |  |   |  |
|--|--|---|--|
| <p>N8 PACKAGE<br/>8-LEAD PLASTIC DIP<br/><math>T_{JMAX} = 150^{\circ}\text{C}</math>, <math>\theta_{JA} = 100^{\circ}\text{C/W}</math> (N)</p> <p>J8 PACKAGE<br/>8-LEAD CERAMIC DIP<br/><math>T_{JMAX} = 175^{\circ}\text{C}</math>, <math>\theta_{JA} = 100^{\circ}\text{C/W}</math> (J)</p> <p><b>OBSOLETE PACKAGE</b><br/>Consider S8 or N8 Packages for Alternate Source</p> | <p>ORDER PART NUMBER</p> <p>LT1213CN8<br/>LT1213ACN8</p> <p>LT1213MJ8<br/>LT1213AMJ8</p> | <p>S8 PACKAGE<br/>8-LEAD PLASTIC SOIC<br/><math>T_{JMAX} = 150^{\circ}\text{C}</math>, <math>\theta_{JA} = 150^{\circ}\text{C/W}</math></p> | <p>ORDER PART NUMBER</p> <p>LT1213CS8</p> <p>S8 PART MARKING</p> <p>1213</p> |
| <p>N PACKAGE<br/>14-LEAD PLASTIC DIP<br/><math>T_{JMAX} = 150^{\circ}\text{C}</math>, <math>\theta_{JA} = 70^{\circ}\text{C/W}</math></p>  | <p>ORDER PART NUMBER</p> <p>LT1214CN</p>   | <p>S PACKAGE<br/>16-LEAD PLASTIC SOIC<br/><math>T_{JMAX} = 150^{\circ}\text{C}</math>, <math>\theta_{JA} = 100^{\circ}\text{C/W}</math></p> | <p>ORDER PART NUMBER</p> <p>LT1214CS</p>                                     |

Consult LTC Marketing for parts specified with wider operating temperature ranges.

## AVAILABLE OPTIONS

| NUMBER OF OP AMPS | $T_A$ RANGE    | MAX $V_{OS}$ (25°C) | MAX TC $V_{OS}$ ( $\Delta V_{OS}/\Delta T$ ) | PACKAGE         |                 |                   |
|-------------------|----------------|---------------------|--|-----------------|-----------------|-------------------|
|                   |                |                     |  | CERAMIC DIP (J) | PLASTIC DIP (N) | SURFACE MOUNT (S) |
| Two (Dual)        | -40°C to 85°C  | 150µV               | 1.5µV/°C                                     |                 | LT1213ACN8      |                   |
|                   |                | 275µV               | 3µV/°C                                       |                 | LT1213CN8       |                   |
|                   |                | 275µV               | 6µV/°C                                       |                 |                 | LT1213CS8         |
| Two (Dual)        | -55°C to 125°C | 150µV               | 1.5µV/°C                                     | LT1213AMJ8      |                 |                   |
|                   |                | 275µV               | 3µV/°C                                       | LT1213MJ8       |                 |                   |
| Four (Quad)       | -40°C to 85°C  | 275µV               | 6µV/°C                                       |                 | LT1214CN        | LT1214CS          |

## 5V ELECTRICAL CHARACTERISTICS

$V_S = 5V$ ,  $V_{CM} = 0.5V$ ,  $V_{OUT} = 0.5V$ ,  $T_A = 25^\circ C$ , unless otherwise noted.

| SYMBOL                              | PARAMETER                                | CONDITIONS                                   | LT1213AC<br>LT1213AM |             |       | LT1213C/LT1213M<br>LT1214C |             |       | UNITS                              |
|-------------------------------------|--|--|----------------------|-------------|-------|----------------------------|-------------|-------|------------------------------------|
|                                     |  |  | MIN                  | TYP         | MAX   | MIN                        | TYP         | MAX   |                                    |
| $V_{OS}$                            | Input Offset Voltage                     |  |                      | 75          | 150   |                            | 100         | 275   | $\mu V$                            |
| $\frac{\Delta V_{OS}}{\Delta Time}$ | Long-Term Input Offset Voltage Stability |  |                      | 0.5         |       |                            | 0.6         |       | $\mu V/Mo$                         |
| $I_{OS}$                            | Input Offset Current                     |  |                      | 5           | 30    |                            | 5           | 40    | nA                                 |
| $I_B$                               | Input Bias Current                       |  |                      | 80          | 160   |                            | 100         | 200   | nA                                 |
|                                     | Input Noise Voltage                      | 0.1Hz to 10Hz                                |                      | 200         |       |                            | 200         |       | nV <sub>P-P</sub>                  |
| $e_n$                               | Input Noise Voltage Density              | $f_0 = 10Hz$<br>$f_0 = 1000Hz$               |                      | 10          |       |                            | 10          |       | nV/ $\sqrt{Hz}$<br>nV/ $\sqrt{Hz}$ |
| $i_n$                               | Input Noise Current Density              | $f_0 = 10Hz$<br>$f_0 = 1000Hz$               |                      | 0.9         |       |                            | 0.9         |       | pA/ $\sqrt{Hz}$<br>pA/ $\sqrt{Hz}$ |
|                                     | Input Resistance (Note 4)                | Differential Mode<br>Common Mode             | 10                   | 40<br>200   |       | 10                         | 40<br>200   |       | M $\Omega$<br>M $\Omega$           |
|                                     | Input Capacitance                        | $f = 1MHz$                                   |                      | 10          |       |                            | 10          |       | pF                                 |
|                                     | Input Voltage Range                      |  | 3.5<br>0             | 3.8<br>-0.3 |       | 3.5<br>0                   | 3.8<br>-0.3 |       | V<br>V                             |
| CMRR                                | Common Mode Rejection Ratio              | $V_{CM} = 0V$ to 3.5V                        | 90                   | 105         |       | 86                         | 105         |       | dB                                 |
| PSRR                                | Power Supply Rejection Ratio             | $V_S = 2.5V$ to 12.5V                        | 93                   | 116         |       | 90                         | 116         |       | dB                                 |
| $A_{VOL}$                           | Large-Signal Voltage Gain                | $V_O = 0.05V$ to 3.7V, $R_L = 500\Omega$     | 250                  | 850         |       | 250                        | 850         |       | V/mV                               |
|                                     | Maximum Output Voltage Swing (Note 5)    | Output High, No Load                         | 4.30                 | 4.39        |       | 4.30                       | 4.39        |       | V                                  |
|                                     |  | Output High, $I_{SOURCE} = 1mA$              | 4.20                 | 4.30        |       | 4.20                       | 4.30        |       | V                                  |
|                                     |  | Output High, $I_{SOURCE} = 20mA$             | 3.80                 | 3.92        |       | 3.80                       | 3.92        |       | V                                  |
|                                     |  | Output Low, No Load                          |                      | 0.004       | 0.007 |                            | 0.004       | 0.007 | V                                  |
|                                     |  | Output Low, $I_{SINK} = 1mA$                 |                      | 0.033       | 0.050 |                            | 0.033       | 0.050 | V                                  |
|                                     |  | Output Low, $I_{SINK} = 20mA$                |                      | 0.475       | 0.620 |                            | 0.475       | 0.620 | V                                  |
| $I_O$                               | Maximum Output Current                   | (Note 10)                                    | $\pm 30$             | $\pm 50$    |       | $\pm 30$                   | $\pm 50$    |       | mA                                 |
| SR                                  | Slew Rate                                | $A_V = -2$                                   |                      | 8.5         |       |                            | 8.5         |       | V/ $\mu s$                         |
| GBW                                 | Gain-Bandwidth Product                   | $f = 100kHz$                                 |                      | 26          |       |                            | 26          |       | MHz                                |
| $I_S$                               | Supply Current per Amplifier             |  | 2.0                  | 2.7         | 3.8   | 2.0                        | 2.7         | 3.8   | mA                                 |
|                                     | Minimum Supply Voltage                   | Single Supply, $V_{CM} = 0V$                 |                      | 2.2         | 2.5   |                            | 2.2         | 2.5   | V                                  |
|                                     | Full Power Bandwidth                     | $A_V = 1$ , $V_O = 2.5V_{P-P}$               |                      | 1.0         |       |                            | 1.0         |       | MHz                                |
| $t_r$ , $t_f$                       | Rise Time, Fall Time                     | $A_V = 1$ , 10% to 90%, $V_O = 100mV$        |                      | 24          |       |                            | 24          |       | ns                                 |
| OS                                  | Overshoot                                | $A_V = 1$ , $V_O = 100mV$                    |                      | 30          |       |                            | 30          |       | %                                  |
| $t_{PD}$                            | Propagation Delay                        | $A_V = 1$ , $V_O = 100mV$                    |                      | 17          |       |                            | 17          |       | ns                                 |
| $t_S$                               | Settling Time                            | 0.01%, $A_V = 1$ , $\Delta V_O = 2V$         |                      | 500         |       |                            | 500         |       | ns                                 |
|                                     | Open-Loop Output Resistance              | $I_O = 0mA$ , $f = 10MHz$                    |                      | 50          |       |                            | 50          |       | $\Omega$                           |
| THD                                 | Total Harmonic Distortion                | $A_V = 1$ , $V_O = 1V_{RMS}$ , 20Hz to 20kHz |                      | 0.001       |       |                            | 0.001       |       | %                                  |

## 5V ELECTRICAL CHARACTERISTICS

$V_S = 5V$ ,  $V_{CM} = 0.5V$ ,  $V_{OUT} = 0.5V$ ,  $0^\circ C \leq T_A \leq 70^\circ C$ , unless otherwise noted.

| SYMBOL                           | PARAMETER                             | CONDITIONS                                    | LT1213AC |       |       | LT1213C/LT1214C |       |       | UNITS            |
|----------------------------------|---------------------------------------|---|----------|-------|-------|-----------------|-------|-------|------------------|
|                                  |                                       |   | MIN      | TYP   | MAX   | MIN             | TYP   | MAX   |                  |
| $V_{OS}$                         | Input Offset Voltage                  |   |          | 100   | 175   |                 | 150   | 375   | $\mu V$          |
| $\frac{\Delta V_{OS}}{\Delta T}$ | Input Offset Voltage Drift (Note 4)   | 8-Pin DIP Package<br>14-Pin DIP, SOIC Package |          | 0.7   | 1.5   |                 | 1     | 3     | $\mu V/^\circ C$ |
| $I_{OS}$                         | Input Offset Current                  |   |          | 10    | 45    |                 | 10    | 55    | nA               |
| $I_B$                            | Input Bias Current                    |   |          | 90    | 190   |                 | 110   | 230   | nA               |
|                                  | Input Voltage Range                   |   | 3.4      | 3.5   |       | 3.4             | 3.5   |       | V                |
|                                  |                                       |   | 0.1      | -0.1  |       | 0.1             | -0.1  |       | V                |
| CMRR                             | Common Mode Rejection Ratio           | $V_{CM} = 0.1V$ to $3.4V$                     | 89       | 105   |       | 85              | 105   |       | dB               |
| PSRR                             | Power Supply Rejection Ratio          | $V_S = 2.5V$ to $12.5V$                       | 92       | 114   |       | 89              | 114   |       | dB               |
| $A_{VOL}$                        | Large-Signal Voltage Gain             | $V_O = 0.05V$ to $3.7V$ , $R_L = 500\Omega$   | 200      | 580   |       | 200             | 580   |       | V/mV             |
|                                  | Maximum Output Voltage Swing (Note 5) | Output High, No Load                          | 4.20     | 4.33  |       | 4.20            | 4.33  |       | V                |
|                                  |                                       | Output High, $I_{SOURCE} = 1mA$               | 4.10     | 4.25  |       | 4.10            | 4.25  |       | V                |
|                                  |                                       | Output High, $I_{SOURCE} = 15mA$              | 3.84     | 3.96  |       | 3.84            | 3.96  |       | V                |
|                                  |                                       | Output Low, No Load                           |          | 0.005 | 0.008 |                 | 0.005 | 0.008 | V                |
|                                  |                                       | Output Low, $I_{SINK} = 1mA$                  |          | 0.036 | 0.055 |                 | 0.036 | 0.055 | V                |
|                                  |                                       | Output Low, $I_{SINK} = 15mA$                 |          | 0.370 | 0.530 |                 | 0.370 | 0.530 | V                |
| $I_S$                            | Supply Current per Amplifier          |   | 1.8      | 2.9   | 4.0   | 1.8             | 2.9   | 4.0   | mA               |

$V_S = 5V$ ,  $V_{CM} = 0.5V$ ,  $V_{OUT} = 0.5V$ ,  $-40^\circ C \leq T_A \leq 85^\circ C$ , unless otherwise noted. (Note 6)

| SYMBOL                           | PARAMETER                             | CONDITIONS                                    | LT1213AC |       |       | LT1213C/LT1214C |       |       | UNITS            |
|----------------------------------|---------------------------------------|---|----------|-------|-------|-----------------|-------|-------|------------------|
|                                  |                                       |   | MIN      | TYP   | MAX   | MIN             | TYP   | MAX   |                  |
| $V_{OS}$                         | Input Offset Voltage                  |   |          | 120   | 200   |                 | 175   | 500   | $\mu V$          |
| $\frac{\Delta V_{OS}}{\Delta T}$ | Input Offset Voltage Drift (Note 4)   | 8-Pin DIP Package<br>14-Pin DIP, SOIC Package |          | 0.7   | 1.5   |                 | 1     | 3     | $\mu V/^\circ C$ |
| $I_{OS}$                         | Input Offset Current                  |   |          | 15    | 50    |                 | 20    | 75    | nA               |
| $I_B$                            | Input Bias Current                    |   |          | 100   | 200   |                 | 120   | 250   | nA               |
|                                  | Input Voltage Range                   |   | 3.1      | 3.2   |       | 3.1             | 3.2   |       | V                |
|                                  |                                       |   | 0.2      | 0     |       | 0.2             | 0     |       | V                |
| CMRR                             | Common Mode Rejection Ratio           | $V_{CM} = 0.2V$ to $3.1V$                     | 88       | 104   |       | 84              | 104   |       | dB               |
| PSRR                             | Power Supply Rejection Ratio          | $V_S = 2.5V$ to $12.5V$                       | 91       | 113   |       | 88              | 113   |       | dB               |
| $A_{VOL}$                        | Large-Signal Voltage Gain             | $V_O = 0.05V$ to $3.7V$ , $R_L = 500\Omega$   | 200      | 510   |       | 200             | 510   |       | V/mV             |
|                                  | Maximum Output Voltage Swing (Note 5) | Output High, No Load                          | 4.15     | 4.25  |       | 4.15            | 4.25  |       | V                |
|                                  |                                       | Output High, $I_{SOURCE} = 1mA$               | 4.00     | 4.16  |       | 4.00            | 4.16  |       | V                |
|                                  |                                       | Output High, $I_{SOURCE} = 15mA$              | 3.72     | 3.89  |       | 3.72            | 3.89  |       | V                |
|                                  |                                       | Output Low, No Load                           |          | 0.006 | 0.009 |                 | 0.006 | 0.009 | V                |
|                                  |                                       | Output Low, $I_{SINK} = 1mA$                  |          | 0.037 | 0.060 |                 | 0.037 | 0.060 | V                |
|                                  |                                       | Output Low, $I_{SINK} = 15mA$                 |          | 0.380 | 0.550 |                 | 0.380 | 0.550 | V                |
| $I_S$                            | Supply Current per Amplifier          |   | 1.5      | 2.9   | 4.0   | 1.5             | 2.9   | 4.0   | mA               |

## 5V ELECTRICAL CHARACTERISTICS

$V_S = 5V$ ,  $V_{CM} = 0.5V$ ,  $V_{OUT} = 0.5V$ ,  $-55^\circ C \leq T_A \leq 125^\circ C$ , unless otherwise noted.

| SYMBOL                           | PARAMETER                             | CONDITIONS                                  | LT1213AM |       |       | LT1213M |       |       | UNITS            |
|----------------------------------|---------------------------------------|---|----------|-------|-------|---------|-------|-------|------------------|
|                                  |                                       |   | MIN      | TYP   | MAX   | MIN     | TYP   | MAX   |                  |
| $V_{OS}$                         | Input Offset Voltage                  |   |          | 140   | 250   |         | 200   | 500   | $\mu V$          |
| $\frac{\Delta V_{OS}}{\Delta T}$ | Input Offset Voltage Drift (Note 4)   |   |          | 0.7   | 1.5   |         | 1.0   | 3.0   | $\mu V/^\circ C$ |
| $I_{OS}$                         | Input Offset Current                  |   |          | 20    | 70    |         | 25    | 100   | nA               |
| $I_B$                            | Input Bias Current                    |   |          | 105   | 210   |         | 125   | 275   | nA               |
|                                  | Input Voltage Range                   |   | 3.1      | 3.2   |       | 3.1     | 3.2   |       | V                |
|                                  |                                       |   |          | 0.4   | 0.2   |         | 0.4   | 0.2   |                  |
| CMRR                             | Common Mode Rejection Ratio           | $V_{CM} = 0.4V$ to $3.1V$                   | 87       | 104   |       | 83      | 104   |       | dB               |
| PSRR                             | Power Supply Rejection Ratio          | $V_S = 2.5V$ to $12.5V$                     | 90       | 113   |       | 87      | 113   |       | dB               |
| $A_{VOL}$                        | Large-Signal Voltage Gain             | $V_O = 0.05V$ to $3.7V$ , $R_L = 500\Omega$ | 150      | 300   |       | 150     | 300   |       | V/mV             |
|                                  | Maximum Output Voltage Swing (Note 5) | Output High, No Load                        | 4.05     | 4.20  |       | 4.05    | 4.20  |       | V                |
|                                  |                                       | Output High, $I_{SOURCE} = 1mA$             | 3.90     | 4.10  |       | 3.90    | 4.10  |       | V                |
|                                  |                                       | Output High, $I_{SOURCE} = 15mA$            | 3.60     | 3.80  |       | 3.60    | 3.80  |       | V                |
|                                  |                                       | Output Low, No Load                         |          | 0.007 | 0.012 |         | 0.007 | 0.012 | mV               |
|                                  |                                       | Output Low, $I_{SINK} = 1mA$                |          | 0.040 | 0.070 |         | 0.040 | 0.070 | mV               |
|                                  |                                       | Output Low, $I_{SINK} = 15mA$               |          | 0.400 | 0.750 |         | 0.400 | 0.750 | mV               |
| $I_S$                            | Supply Current per Amplifier          |   | 1.3      | 3.0   | 4.2   | 1.3     | 3.0   | 4.2   | mA               |

## $\pm 15V$ ELECTRICAL CHARACTERISTICS

$V_S = \pm 15V$ ,  $V_{CM} = 0V$ ,  $V_{OUT} = 0V$ ,  $T_A = 25^\circ C$ , unless otherwise noted.

| SYMBOL    | PARAMETER                    | CONDITIONS                            | LT1213AC<br>LT1213AM |           |           | LT1213C/LT1213M<br>LT1214C |           |           | UNITS      |
|-----------|------------------------------|---------------------------------------|----------------------|-----------|-----------|----------------------------|-----------|-----------|------------|
|           |                              |                                       | MIN                  | TYP       | MAX       | MIN                        | TYP       | MAX       |            |
| $V_{OS}$  | Input Offset Voltage         |                                       |                      | 125       | 400       |                            | 150       | 550       | $\mu V$    |
| $I_{OS}$  | Input Offset Current         |                                       |                      | 5         | 30        |                            | 5         | 40        | nA         |
| $I_B$     | Input Bias Current           |                                       |                      | 70        | 150       |                            | 90        | 190       | nA         |
|           | Input Voltage Range          |                                       | 13.5                 | 13.8      |           | 13.5                       | 13.8      |           | V          |
|           |                              |                                       |                      | -15.0     | -15.3     |                            | -15.0     | -15.3     |            |
| CMRR      | Common Mode Rejection Ratio  | $V_{CM} = -15V$ to $13.5V$            | 90                   | 107       |           | 86                         | 107       |           | dB         |
| PSRR      | Power Supply Rejection Ratio | $V_S = \pm 2V$ to $\pm 18V$           | 93                   | 116       |           | 90                         | 116       |           | dB         |
| $A_{VOL}$ | Large-Signal Voltage Gain    | $V_O = 0V$ to $\pm 10V$ , $R_L = 2k$  | 1200                 | 4000      |           | 1200                       | 4000      |           | V/mV       |
|           | Maximum Output Voltage Swing | Output High, $I_{SOURCE} = 20mA$      | 13.7                 | 13.9      |           | 13.7                       | 13.9      |           | V          |
|           |                              | Output Low, $I_{SINK} = 20mA$         | -14.3                | -14.5     |           | -14.3                      | -14.5     |           | V          |
| $I_O$     | Maximum Output Current       | (Note 10)                             | $\pm 30$             | $\pm 50$  |           | $\pm 30$                   | $\pm 50$  |           | mA         |
| SR        | Slew Rate                    | $A_V = -2$ (Note 7)                   | 10                   | 12        |           | 10                         | 12        |           | V/ $\mu s$ |
| GBW       | Gain-Bandwidth Product       | $f = 100kHz$                          | 15                   | 28        |           | 15                         | 28        |           | MHz        |
| $I_S$     | Supply Current per Amplifier |                                       | 2.0                  | 3.4       | 4.7       | 2.0                        | 3.4       | 4.7       | mA         |
|           | Channel Separation           | $V_O = \pm 10V$ , $R_L = 2k$          | 128                  | 140       |           | 128                        | 140       |           | dB         |
|           | Minimum Supply Voltage       | Equal Split Supplies                  |                      | $\pm 1.2$ | $\pm 2.0$ |                            | $\pm 1.2$ | $\pm 2.0$ | V          |
|           | Full-Power Bandwidth         | $A_V = 1$ , $V_O = 20V_{P-P}$         |                      | 150       |           |                            | 150       |           | kHz        |
|           | Settling Time                | 0.01%, $A_V = 1$ , $\Delta V_O = 10V$ |                      | 1.1       |           |                            | 1.1       |           | $\mu s$    |

## ±15V ELECTRICAL CHARACTERISTICS

$V_S = \pm 15V$ ,  $V_{CM} = 0V$ ,  $V_{OUT} = 0V$ ,  $0^\circ C \leq T_A \leq 70^\circ C$ , unless otherwise noted.

| SYMBOL                           | PARAMETER                           | CONDITIONS                                    | LT1213AC      |               |       | LT1213C/LT1214C |               |       | UNITS            |    |
|----------------------------------|-------------------------------------|---|---------------|---------------|-------|-----------------|---------------|-------|------------------|----|
|                                  |                                     |   | MIN           | TYP           | MAX   | MIN             | TYP           | MAX   |                  |    |
| $V_{OS}$                         | Input Offset Voltage                |   |               | 150           | 425   |                 | 200           | 650   | $\mu V$          |    |
| $\frac{\Delta V_{OS}}{\Delta T}$ | Input Offset Voltage Drift (Note 4) | 8-Pin DIP Package<br>14-Pin DIP, SOIC Package |               | 0.7           | 1.5   |                 | 1             | 3     | $\mu V/^\circ C$ |    |
| $I_{OS}$                         | Input Offset Current                |   |               | 10            | 35    |                 | 10            | 45    | nA               |    |
| $I_B$                            | Input Bias Current                  |   |               | 90            | 160   |                 | 95            | 200   | nA               |    |
|                                  | Input Voltage Range                 |   | 13.4<br>-14.9 | 13.5<br>-15.1 |       | 13.4<br>-14.9   | 13.5<br>-15.1 |       | V<br>V           |    |
| CMRR                             | Common Mode Rejection Ratio         | $V_{CM} = -14.9V$ to $13.4V$                  |               | 89            | 105   |                 | 85            | 105   | dB               |    |
| PSRR                             | Power Supply Rejection Ratio        | $V_S = \pm 2V$ to $\pm 18V$                   |               | 92            | 115   |                 | 89            | 115   | dB               |    |
| $A_{VOL}$                        | Large-Signal Voltage Gain           | $V_O = 0V$ to $\pm 10V$ , $R_L = 2k$          |               | 1000          | 4000  |                 | 1000          | 4000  | V/mV             |    |
|                                  | Maximum Output Voltage Swing        | Output High, $I_{SOURCE} = 15mA$              |               | 13.8          | 14.0  |                 | 13.8          | 14.0  | V                |    |
|                                  |                                     | Output Low, $I_{SINK} = 15mA$                 |               | -14.4         | -14.6 |                 | -14.4         | -14.6 | V                |    |
| $I_S$                            | Supply Current per Amplifier        |   |               | 1.8           | 3.7   | 5.0             | 1.8           | 3.7   | 5.0              | mA |

$V_S = \pm 15V$ ,  $V_{CM} = 0V$ ,  $V_{OUT} = 0V$ ,  $-40^\circ C \leq T_A \leq 85^\circ C$ , unless otherwise noted. (Note 6)

| SYMBOL                           | PARAMETER                           | CONDITIONS                                    | LT1213AC      |               |       | LT1213C/LT1214C |               |       | UNITS            |    |
|----------------------------------|-------------------------------------|---|---------------|---------------|-------|-----------------|---------------|-------|------------------|----|
|                                  |                                     |   | MIN           | TYP           | MAX   | MIN             | TYP           | MAX   |                  |    |
| $V_{OS}$                         | Input Offset Voltage                |   |               | 175           | 450   |                 | 250           | 700   | $\mu V$          |    |
| $\frac{\Delta V_{OS}}{\Delta T}$ | Input Offset Voltage Drift (Note 4) | 8-Pin DIP Package<br>14-Pin DIP, SOIC Package |               | 0.7           | 1.5   |                 | 1             | 3     | $\mu V/^\circ C$ |    |
| $I_{OS}$                         | Input Offset Current                |   |               | 10            | 40    |                 | 20            | 75    | nA               |    |
| $I_B$                            | Input Bias Current                  |   |               | 95            | 180   |                 | 105           | 220   | nA               |    |
|                                  | Input Voltage Range                 |   | 13.1<br>-14.8 | 13.2<br>-15.0 |       | 13.1<br>-14.8   | 13.2<br>-15.0 |       | V<br>V           |    |
| CMRR                             | Common Mode Rejection Ratio         | $V_{CM} = -14.8V$ to $13.1V$                  |               | 88            | 104   |                 | 84            | 104   | dB               |    |
| PSRR                             | Power Supply Rejection Ratio        | $V_S = \pm 2V$ to $\pm 18V$                   |               | 91            | 114   |                 | 88            | 114   | dB               |    |
| $A_{VOL}$                        | Large-Signal Voltage Gain           | $V_O = 0V$ to $\pm 10V$ , $R_L = 2k$          |               | 1000          | 4000  |                 | 1000          | 4000  | V/mV             |    |
|                                  | Maximum Output Voltage Swing        | Output High, $I_{SOURCE} = 15mA$              |               | 13.7          | 13.9  |                 | 13.7          | 13.9  | V                |    |
|                                  |                                     | Output Low, $I_{SINK} = 15mA$                 |               | -14.4         | -14.6 |                 | -14.4         | -14.6 | V                |    |
| $I_S$                            | Supply Current per Amplifier        |   |               | 1.5           | 3.7   | 5.1             | 1.5           | 3.7   | 5.1              | mA |

$V_S = \pm 15V$ ,  $V_{CM} = 0V$ ,  $V_{OUT} = 0V$ ,  $-55^\circ C \leq T_A \leq 125^\circ C$ , unless otherwise noted.

| SYMBOL                           | PARAMETER                           | CONDITIONS                           | LT1213AM      |               |       | LT1213M       |               |       | UNITS            |    |
|----------------------------------|-------------------------------------|--------------------------------------|---------------|---------------|-------|---------------|---------------|-------|------------------|----|
|                                  |                                     |                                      | MIN           | TYP           | MAX   | MIN           | TYP           | MAX   |                  |    |
| $V_{OS}$                         | Input Offset Voltage                |                                      |               | 200           | 500   |               | 300           | 800   | $\mu V$          |    |
| $\frac{\Delta V_{OS}}{\Delta T}$ | Input Offset Voltage Drift (Note 4) |                                      |               | 0.7           | 1.5   |               | 1             | 3     | $\mu V/^\circ C$ |    |
| $I_{OS}$                         | Input Offset Current                |                                      |               | 15            | 60    |               | 25            | 90    | nA               |    |
| $I_B$                            | Input Bias Current                  |                                      |               | 100           | 200   |               | 110           | 250   | nA               |    |
|                                  | Input Voltage Range                 |                                      | 13.1<br>-14.6 | 13.2<br>-14.8 |       | 13.1<br>-14.6 | 13.2<br>-14.8 |       | V<br>V           |    |
| CMRR                             | Common Mode Rejection Ratio         | $V_{CM} = -14.6V$ to $13.1V$         |               | 87            | 104   |               | 83            | 104   | dB               |    |
| PSRR                             | Power Supply Rejection Ratio        | $V_S = \pm 2V$ to $\pm 15V$          |               | 90            | 114   |               | 87            | 114   | dB               |    |
| $A_{VOL}$                        | Large-Signal Voltage Gain           | $V_O = 0V$ to $\pm 10V$ , $R_L = 2k$ |               | 800           | 1100  |               | 800           | 1100  | V/mV             |    |
|                                  | Maximum Output Voltage Swing        | Output High, $I_{SOURCE} = 15mA$     |               | 13.6          | 13.8  |               | 13.6          | 13.8  | V                |    |
|                                  |                                     | Output Low, $I_{SINK} = 15mA$        |               | -14.2         | -14.5 |               | -14.2         | -14.5 | V                |    |
| $I_S$                            | Supply Current per Amplifier        |                                      |               | 1.3           | 4.0   | 5.4           | 1.3           | 4.0   | 5.4              | mA |

### 3.3V ELECTRICAL CHARACTERISTICS

$V_S = 3.3V$ ,  $V_{CM} = 0.5V$ ,  $V_{OUT} = 0.5V$ ,  $T_A = 25^\circ C$ , unless otherwise noted. (Note 8)

| SYMBOL   | PARAMETER                    | CONDITIONS                       | LT1213AC<br>LT1213AM |          |       | LT1213C/LT1213M<br>LT1214C |          |       | UNITS   |   |
|----------|------------------------------|----------------------------------|----------------------|----------|-------|----------------------------|----------|-------|---------|---|
|          |                              |                                  | MIN                  | TYP      | MAX   | MIN                        | TYP      | MAX   |         |   |
| $V_{OS}$ | Input Offset Voltage         |                                  |                      | 75       | 150   |                            | 100      | 275   | $\mu V$ |   |
|          | Input Voltage Range (Note 9) |                                  | 1.8                  | 2.1      |       | 1.8                        | 2.1      |       | V       |   |
|          |                              |                                  | 0                    | -0.3     |       | 0                          | -0.3     |       | V       |   |
|          | Maximum Output Voltage Swing | Output High, No Load             | 2.60                 | 2.69     |       | 2.60                       | 2.69     |       | V       |   |
|          |                              | Output High, $I_{SOURCE} = 1mA$  | 2.50                 | 2.60     |       | 2.50                       | 2.60     |       | V       |   |
|          |                              | Output High, $I_{SOURCE} = 20mA$ | 2.10                 | 2.22     |       | 2.10                       | 2.22     |       | V       |   |
|          |                              | Output Low, No Load              |                      | 0.004    | 0.007 |                            | 0.004    | 0.007 |         | V |
|          |                              | Output Low, $I_{SINK} = 1mA$     |                      | 0.033    | 0.050 |                            | 0.033    | 0.050 |         | V |
|          |                              | Output Low, $I_{SINK} = 20mA$    |                      | 0.475    | 0.620 |                            | 0.475    | 0.620 |         | V |
| $I_O$    | Maximum Output Current       |                                  | $\pm 30$             | $\pm 50$ |       | $\pm 30$                   | $\pm 50$ |       | mA      |   |

$V_S = 3.3V$ ,  $V_{CM} = 0.5V$ ,  $V_{OUT} = 0.5V$ ,  $0^\circ C \leq T_A \leq 70^\circ C$ , unless otherwise noted. (Note 8)

| SYMBOL   | PARAMETER                    | CONDITIONS                       | LT1213AC |       |       | LT1213C/LT1214C |       |       | UNITS   |   |
|----------|------------------------------|----------------------------------|----------|-------|-------|-----------------|-------|-------|---------|---|
|          |                              |                                  | MIN      | TYP   | MAX   | MIN             | TYP   | MAX   |         |   |
| $V_{OS}$ | Input Offset Voltage         |                                  |          | 100   | 175   |                 | 150   | 375   | $\mu V$ |   |
|          | Input Voltage Range (Note 9) |                                  | 1.7      | 1.8   |       | 1.7             | 1.8   |       | V       |   |
|          |                              |                                  | 0.1      | -0.1  |       | 0.1             | -0.1  |       | V       |   |
|          | Maximum Output Voltage Swing | Output High, No Load             | 2.50     | 2.63  |       | 2.50            | 2.63  |       | V       |   |
|          |                              | Output High, $I_{SOURCE} = 1mA$  | 2.40     | 2.55  |       | 2.40            | 2.55  |       | V       |   |
|          |                              | Output High, $I_{SOURCE} = 15mA$ | 2.14     | 2.26  |       | 2.14            | 2.26  |       | V       |   |
|          |                              | Output Low, No Load              |          | 0.005 | 0.008 |                 | 0.005 | 0.008 |         | V |
|          |                              | Output Low, $I_{SINK} = 1mA$     |          | 0.037 | 0.055 |                 | 0.037 | 0.055 |         | V |
|          |                              | Output Low, $I_{SINK} = 15mA$    |          | 0.400 | 0.530 |                 | 0.400 | 0.530 |         | V |

$V_S = 3.3V$ ,  $V_{CM} = 0.5V$ ,  $V_{OUT} = 0.5V$ ,  $-40^\circ C \leq T_A \leq 85^\circ C$ , unless otherwise noted. (Note 6, 8)

| SYMBOL   | PARAMETER                    | CONDITIONS                       | LT1213AC |       |       | LT1213C/LT1214C |       |       | UNITS   |   |
|----------|------------------------------|----------------------------------|----------|-------|-------|-----------------|-------|-------|---------|---|
|          |                              |                                  | MIN      | TYP   | MAX   | MIN             | TYP   | MAX   |         |   |
| $V_{OS}$ | Input Offset Voltage         |                                  |          | 120   | 200   |                 | 175   | 500   | $\mu V$ |   |
|          | Input Voltage Range (Note 9) |                                  | 1.4      | 1.5   |       | 1.4             | 1.5   |       | V       |   |
|          |                              |                                  | 0.2      | 0     |       | 0.2             | 0     |       | V       |   |
|          | Maximum Output Voltage Swing | Output High, No Load             | 2.45     | 2.55  |       | 2.45            | 2.55  |       | V       |   |
|          |                              | Output High, $I_{SOURCE} = 1mA$  | 2.30     | 2.46  |       | 2.30            | 2.46  |       | V       |   |
|          |                              | Output High, $I_{SOURCE} = 15mA$ | 2.02     | 2.19  |       | 2.02            | 2.19  |       | V       |   |
|          |                              | Output Low, No Load              |          | 0.006 | 0.009 |                 | 0.006 | 0.009 |         | V |
|          |                              | Output Low, $I_{SINK} = 1mA$     |          | 0.040 | 0.060 |                 | 0.040 | 0.060 |         | V |
|          |                              | Output Low, $I_{SINK} = 15mA$    |          | 0.410 | 0.550 |                 | 0.410 | 0.550 |         | V |

$V_S = 3.3V$ ,  $V_{CM} = 0.5V$ ,  $V_{OUT} = 0.5V$ ,  $-55^\circ C \leq T_A \leq 125^\circ C$ , unless otherwise noted. (Note 8)

| SYMBOL   | PARAMETER                    | CONDITIONS                       | LT1213AM |       |       | LT1213M |       |       | UNITS   |   |
|----------|------------------------------|----------------------------------|----------|-------|-------|---------|-------|-------|---------|---|
|          |                              |                                  | MIN      | TYP   | MAX   | MIN     | TYP   | MAX   |         |   |
| $V_{OS}$ | Input Offset Voltage         |                                  |          | 130   | 250   |         | 200   | 500   | $\mu V$ |   |
|          | Input Voltage Range (Note 9) |                                  | 1.4      | 1.5   |       | 1.4     | 1.5   |       | V       |   |
|          |                              |                                  | 0.4      | 0.2   |       | 0.4     | 0.2   |       | V       |   |
|          | Maximum Output Voltage Swing | Output High, No Load             | 2.35     | 2.50  |       | 2.35    | 2.50  |       | V       |   |
|          |                              | Output High, $I_{SOURCE} = 1mA$  | 2.20     | 2.40  |       | 2.20    | 2.40  |       | V       |   |
|          |                              | Output High, $I_{SOURCE} = 15mA$ | 1.90     | 2.10  |       | 1.90    | 2.10  |       | V       |   |
|          |                              | Output Low, No Load              |          | 0.007 | 0.012 |         | 0.007 | 0.012 |         | V |
|          |                              | Output Low, $I_{SINK} = 1mA$     |          | 0.040 | 0.070 |         | 0.040 | 0.070 |         | V |
|          |                              | Output Low, $I_{SINK} = 15mA$    |          | 0.500 | 0.750 |         | 0.500 | 0.750 |         | V |

## ELECTRICAL CHARACTERISTICS

**Note 1:** Absolute Maximum Ratings are those values beyond which the life of a device may be impaired.

**Note 2:** A heat sink may be required to keep the junction temperature below absolute maximum when the output is shorted indefinitely.

**Note 3:**  $T_J$  is calculated from the ambient temperature  $T_A$  and power dissipation  $P_D$  according to the following formulas:

|                        |   |
|------------------------|---|
| LT1213MJ8, LT1213AMJ8: | $T_J = T_A + (P_D \times 100^\circ\text{C}/\text{W})$ |
| LT1213CN8, LT1213ACN8: | $T_J = T_A + (P_D \times 100^\circ\text{C}/\text{W})$ |
| LT1213CS8:             | $T_J = T_A + (P_D \times 150^\circ\text{C}/\text{W})$ |
| LT1214CN:              | $T_J = T_A + (P_D \times 70^\circ\text{C}/\text{W})$  |
| LT1214CS:              | $T_J = T_A + (P_D \times 100^\circ\text{C}/\text{W})$ |

**Note 4:** This parameter is not 100% tested.

**Note 5:** Guaranteed by correlation to 3.3V and  $\pm 15\text{V}$  tests.

**Note 6:** The LT1213/LT1214 are designed, characterized and expected to meet these extended temperature limits, but are not tested at  $-40^\circ\text{C}$  and  $85^\circ\text{C}$ . Guaranteed 1 grade parts are available. Consult factory.

**Note 7:** Slew rate is measured between  $\pm 8.5\text{V}$  on an output swing of  $\pm 10\text{V}$  on  $\pm 15\text{V}$  supplies.

**Note 8:** Most LT1213/LT1214 electrical characteristics change very little with supply voltage. See the 5V tables for characteristics not listed in the 3.3V table.

**Note 9:** Guaranteed by correlation to 5V and  $\pm 15\text{V}$  tests.

**Note 10:** Guaranteed by correlation to 3.3V tests.

## TYPICAL PERFORMANCE CHARACTERISTICS

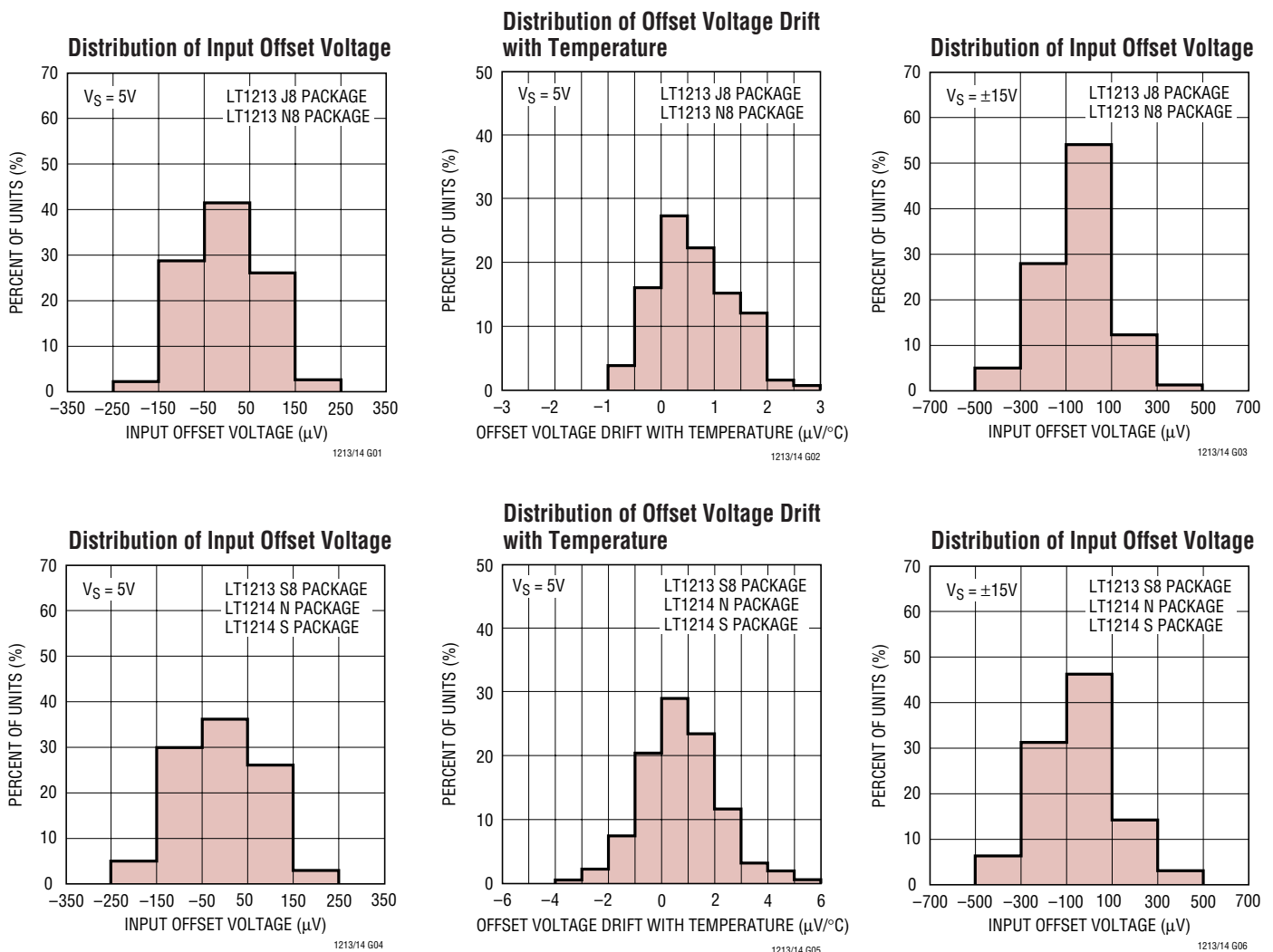

# TYPICAL PERFORMANCE CHARACTERISTICS

Voltage Gain vs Frequency

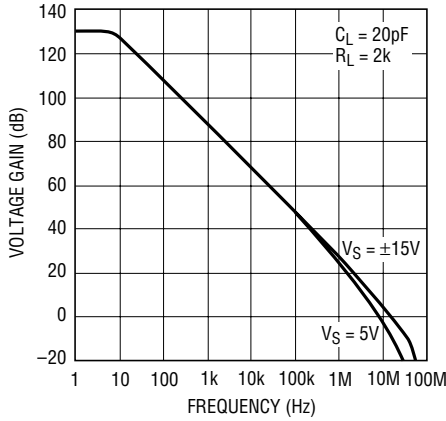

Voltage Gain, Phase vs Frequency

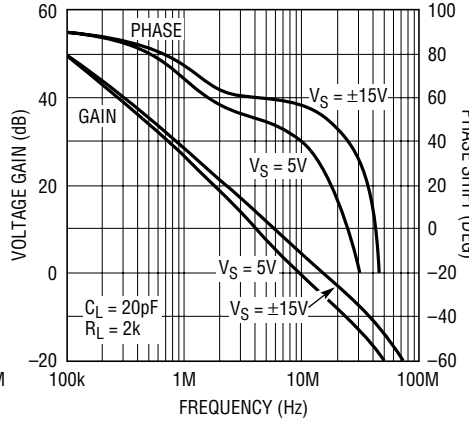

Gain-Bandwidth Product, Phase Margin vs Supply Voltage

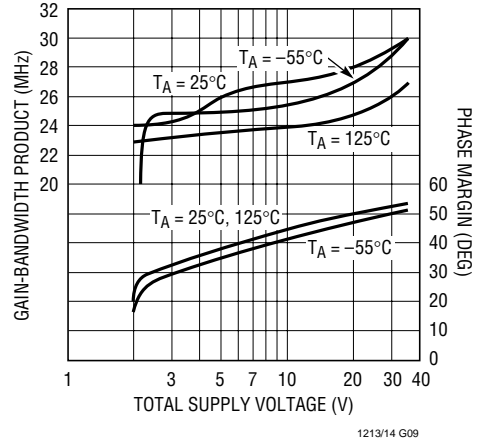

Slew Rate vs Temperature

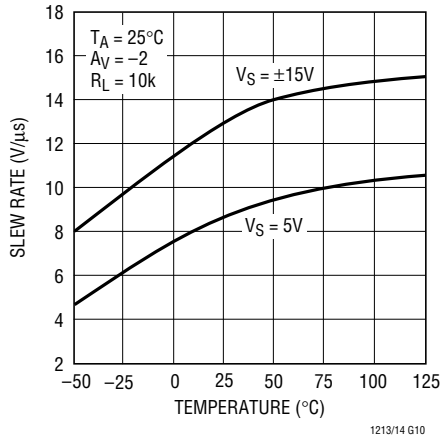

Slew Rate vs Supply Voltage

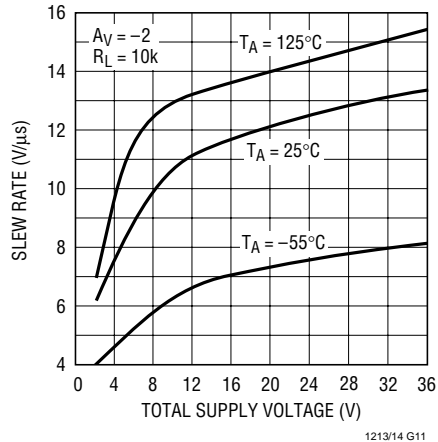

Capacitive Load Handling

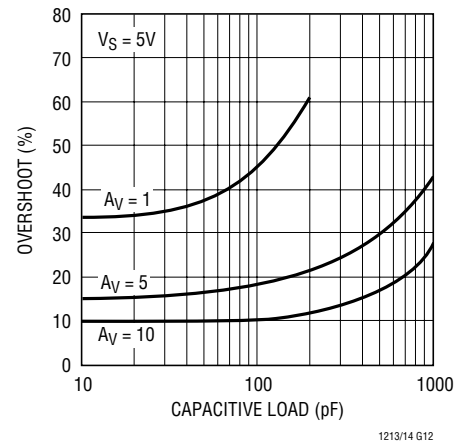

Undistorted Output Swing vs Frequency, VS = 5V

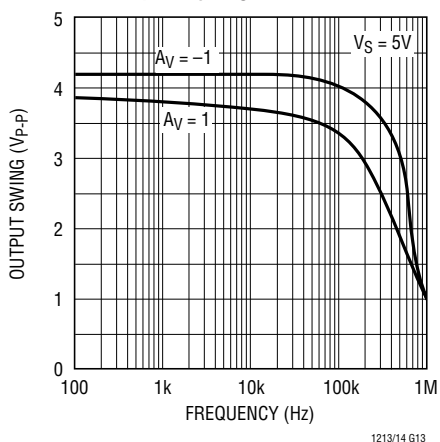

Undistorted Output Swing vs Frequency, VS = ±15V

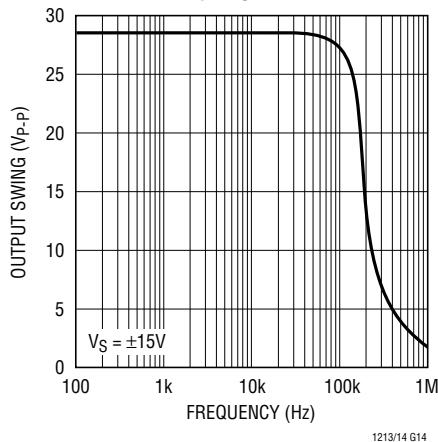

Total Harmonic Distortion and Noise vs Frequency

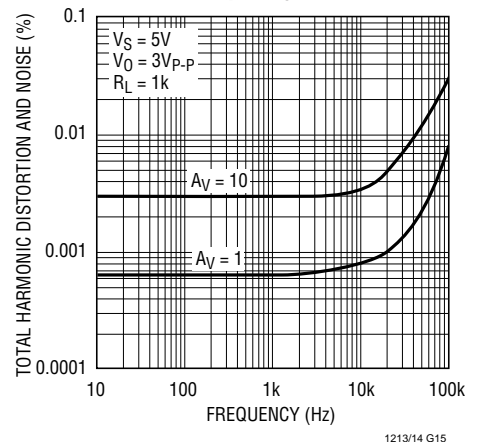

TYPICAL PERFORMANCE CHARACTERISTICS

Open-Loop Voltage Gain vs Supply Voltage

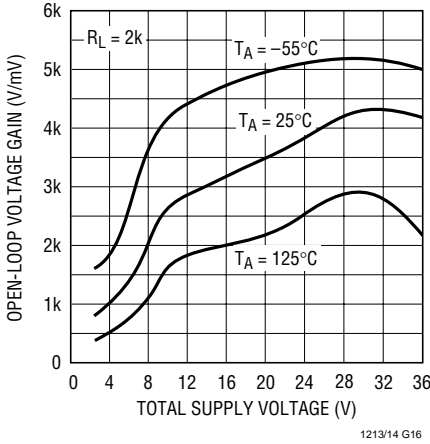

Open-Loop Gain,  $V_S = 5V$

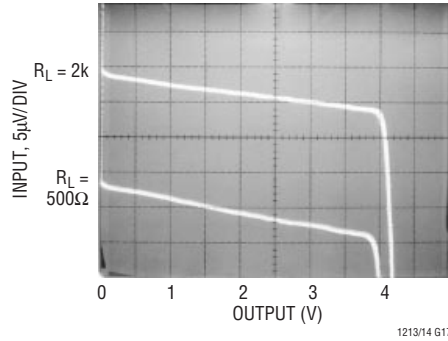

Positive Output Saturation Voltage vs Temperature

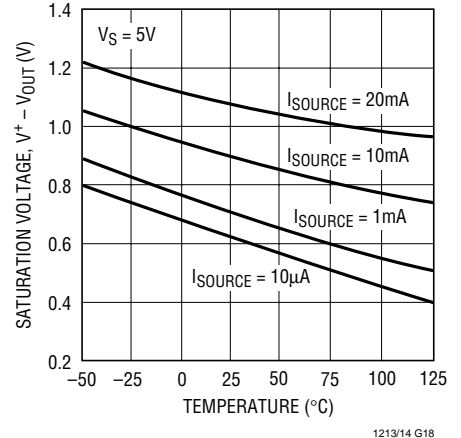

Voltage Gain vs Load Resistance

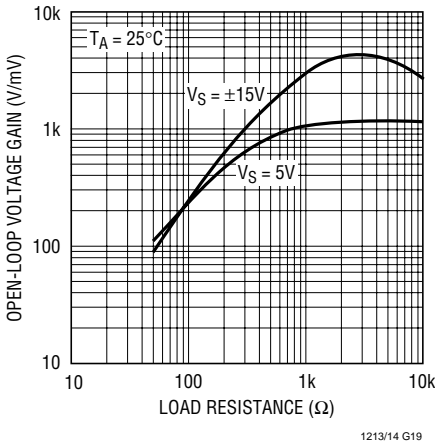

Open-Loop Gain,  $V_S = \pm 15V$

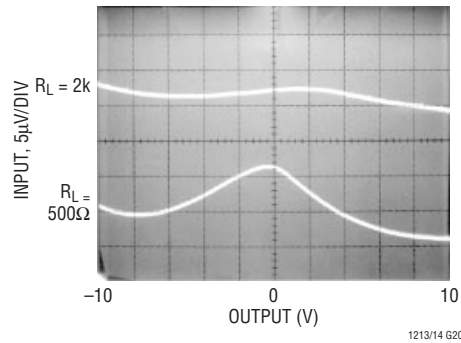

Negative Output Saturation Voltage vs Temperature

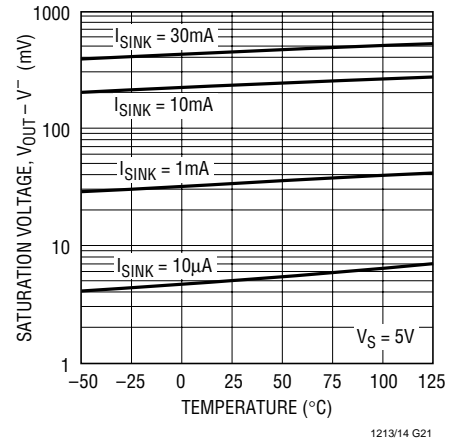

Channel Separation vs Frequency

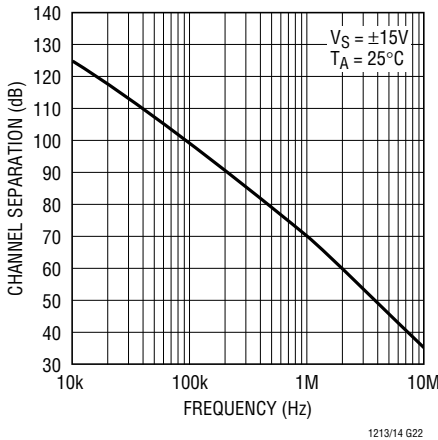

Output Short-Circuit Current vs Temperature

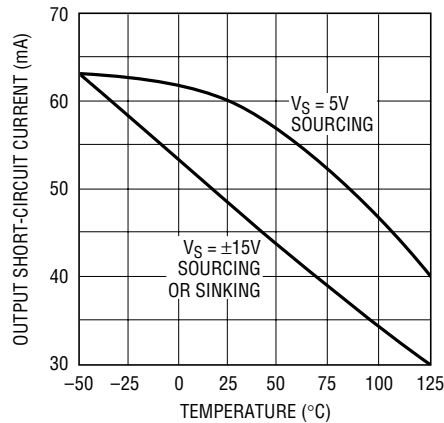

Output Impedance vs Frequency

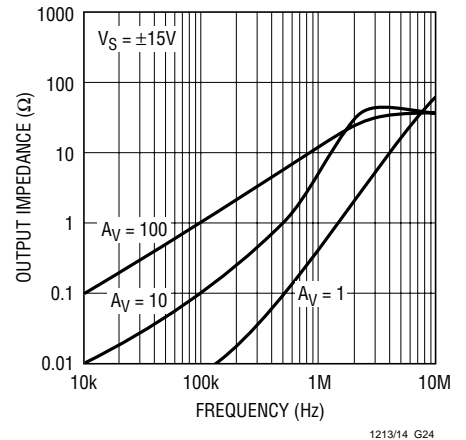

# TYPICAL PERFORMANCE CHARACTERISTICS

**5V Small-Signal Response**

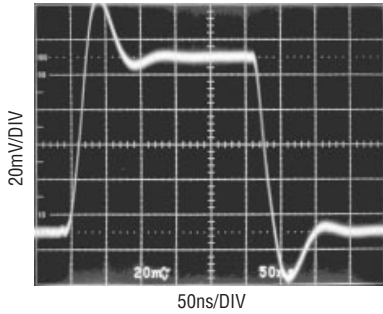

$V_S = 5V$   
 $A_V = 1$   
1213/14 G25

**5V Large-Signal Response**

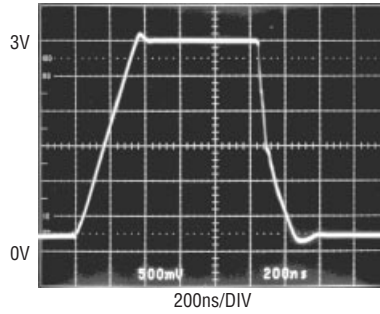

$V_S = 5V$   
 $A_V = 1$   
1213/14 G26

**5V Large-Signal Response**

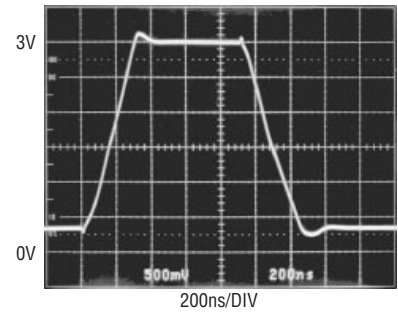

$V_S = 5V$   
 $A_V = -1$   
 $R_F = R_G = 1k$   
 $C_F = 20pF$   
1213/14 G27

**±15V Small-Signal Response**

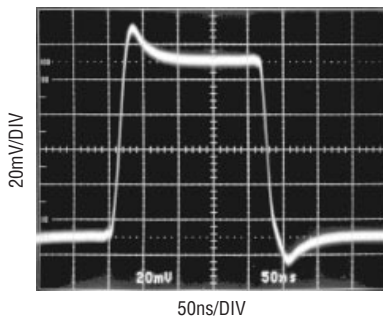

$V_S = \pm 15V$   
 $A_V = 1$   
1213/14 G28

**±15V Large-Signal Response**

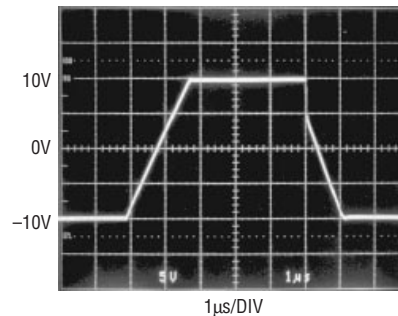

$V_S = \pm 15V$   
 $A_V = 1$   
1213/14 G29

**±15V Large-Signal Response**

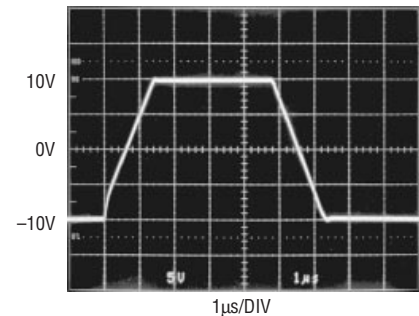

$V_S = \pm 15V$   
 $A_V = -1$   
 $R_F = R_G = 1k$   
1213/14 G30

**5V Settling**

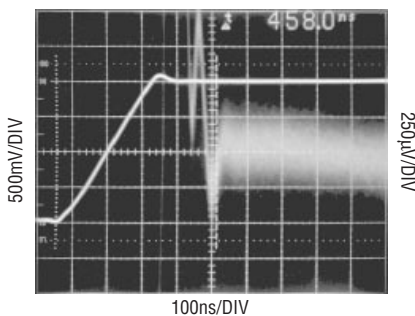

$V_S = 5V$   
 $A_V = 1$   
1213/14 G31

**±15V Settling**

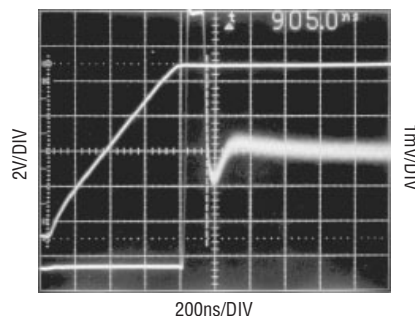

$V_S = \pm 15V$   
 $A_V = -1$   
1213/14 G32

**Settling Time to 0.01% vs Output Step**

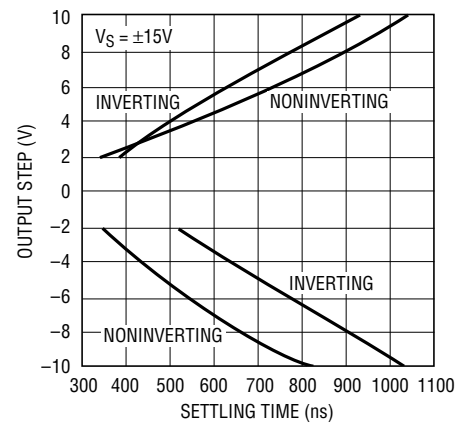

1213/14 G33

TYPICAL PERFORMANCE CHARACTERISTICS

Supply Current vs Supply Voltage

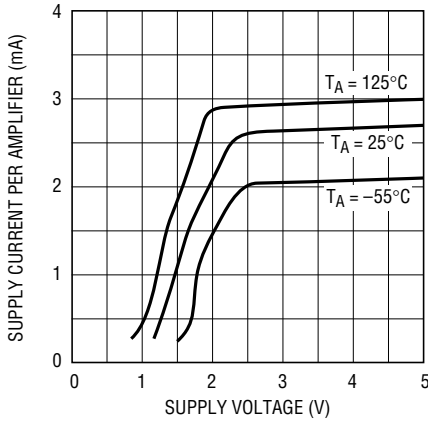

1213/14 G34

Supply Current vs Temperature

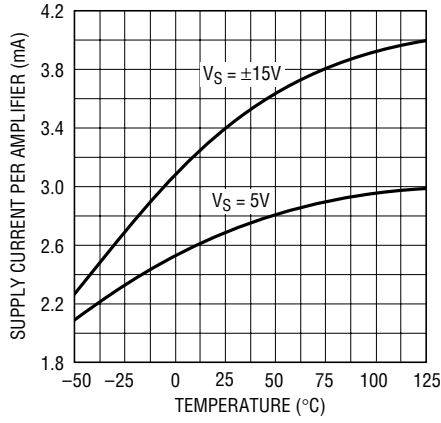

1213/14 G35

Warm-Up Drift vs Time

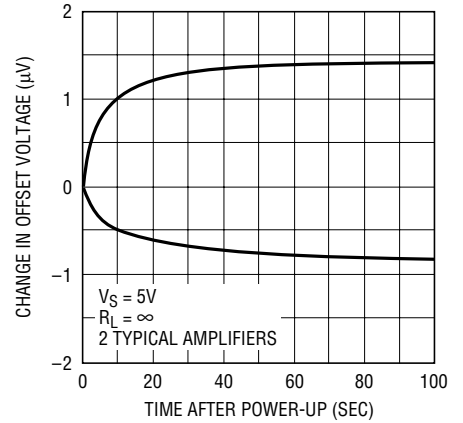

1213/14 G36

Input Bias Current vs Temperature

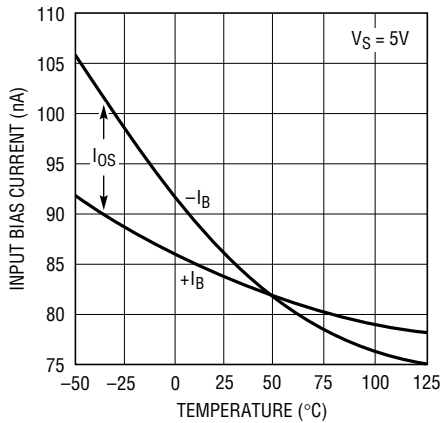

1213/14 G37

Input Bias Current vs Common Mode Voltage

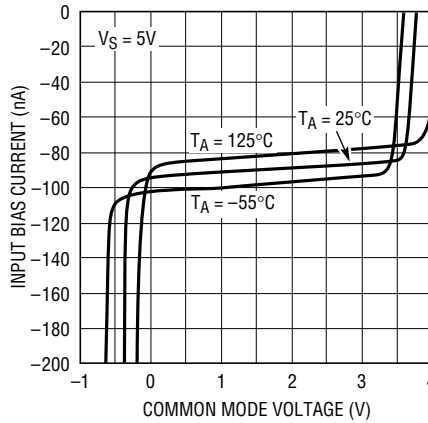

1213/14 G38

Common Mode Range vs Temperature

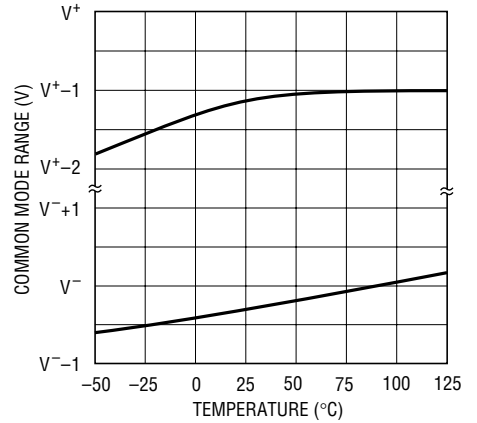

1213/14 G39

Input Noise Current, Noise Voltage Density vs Frequency

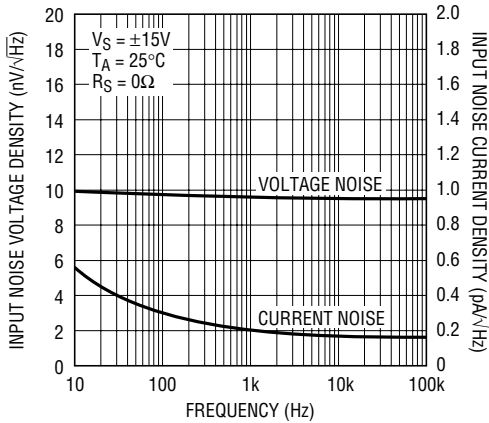

1213/14 G40

Common Mode Rejection Ratio vs Frequency

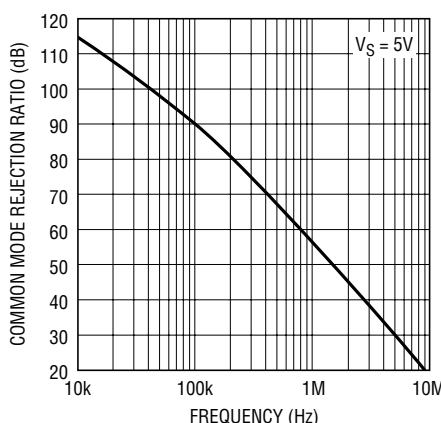

1213/14 G41

Input Referred Power Supply Rejection Ratio vs Frequency

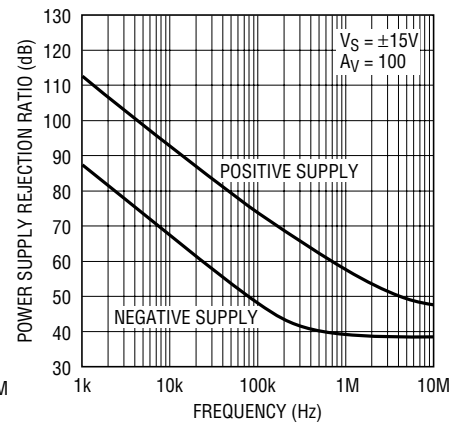

1213/14 G42

## APPLICATIONS INFORMATION

### Supply Voltage

The LT1213/LT1214 op amps are fully functional and all internal bias circuits are in regulation with 2.2V of supply. The amplifiers will continue to function with as little as 1.5V, although the input common mode range and the phase margin are about gone. The minimum operating supply voltage is guaranteed by the PSRR tests which are done with the input common mode equal to 500mV and a minimum supply voltage of 2.5V. The LT1213/LT1214 are guaranteed over the full  $-55^{\circ}\text{C}$  to  $125^{\circ}\text{C}$  range with a minimum supply voltage of 2.5V.

The positive supply pin of the LT1213/LT1214 should be bypassed with a small capacitor (about  $0.01\mu\text{F}$ ) within an inch of the pin. When driving heavy loads and for good settling time, an additional  $4.7\mu\text{F}$  capacitor should be used. When using split supplies, the same is true for the negative supply pin.

### Power Dissipation

The LT1213/LT1214 amplifiers combine high speed and large output current drive into very small packages. Because these amplifiers work over a very wide supply range, it is possible to exceed the maximum junction temperature under certain conditions. To insure that the LT1213/LT1214 are used properly, calculate the worst case power dissipation, define the maximum ambient temperature, select the appropriate package and then calculate the maximum junction temperature.

The worst case amplifier power dissipation is the total of the quiescent current times the total power supply voltage plus the power in the IC due to the load. The quiescent supply current of the LT1213/LT1214 has a positive temperature coefficient. The maximum supply current of each amplifier at  $125^{\circ}\text{C}$  is given by the following formula:

$$I_{\text{SMAX}} = 4.2 + 0.048 \times (V_S - 5) \text{ in mA}$$

$V_S$  is the total supply voltage.

The power in the IC due to the load is a function of the output voltage, the supply voltage and load resistance. The worst case occurs when the output voltage is at half supply, if it can go that far, or its maximum value if it cannot reach half supply.

For example, calculate the worst case power dissipation while operating on  $\pm 15\text{V}$  supplies and driving a  $500\Omega$  load.

$$I_{\text{SMAX}} = 4.2 + 0.048 \times (30 - 5) = 5.4\text{mA}$$

$$P_{\text{DMAX}} = 2 \times V_S \times I_{\text{SMAX}} + (V_S - V_{\text{OMAX}}) \times V_{\text{OMAX}}/R_L$$

$$P_{\text{DMAX}} = 2 \times 15\text{V} \times 5.4\text{mA} + (15\text{V} - 7.5\text{V}) \times 7.5\text{V}/500 \\ = 0.162 + 0.113 = 0.275 \text{ Watt per Amp}$$

If this is the dual LT1213, the total power in the package is twice that, or  $0.550\text{W}$ . Now calculate how much the die temperature will rise above the ambient. The total power dissipation times the thermal resistance of the package gives the amount of temperature rise. For this example, in the SO-8 surface mount package, the thermal resistance is  $150^{\circ}\text{C}/\text{W}$  junction-to-ambient in still air.

$$\text{Temperature Rise} = P_{\text{DMAX}} \times \theta_{\text{JA}} = 0.550\text{W} \times 150^{\circ}\text{C}/\text{W} \\ = 82.5^{\circ}\text{C}$$

The maximum junction temperature allowed in the plastic package is  $150^{\circ}\text{C}$ . Therefore the maximum ambient allowed is the maximum junction temperature less the temperature rise.

$$\text{Maximum Ambient} = 150^{\circ}\text{C} - 82.5^{\circ}\text{C} = 67.5^{\circ}\text{C}$$

That means the SO-8 dual can be operated at or below  $67.5^{\circ}\text{C}$  on  $\pm 15\text{V}$  supplies with a  $500\Omega$  load.

As a guideline to help in the selection of the LT1213/LT1214, the following table describes the maximum supply voltage that can be used with each part based on the following assumptions:

1. The maximum ambient is  $70^{\circ}\text{C}$  or  $125^{\circ}\text{C}$  depending on the part rating.
2. The load is  $500\Omega$  including the feedback resistors.
3. The output can be anywhere between the supplies.

| PART      | MAX SUPPLIES                | MAX POWER AT MAX $T_A$ |
|-----------|-----------------------------|------------------------|
| LT1213MJ8 | 18.0V or $\pm 14.1\text{V}$ | 500mW                  |
| LT1213CN8 | 23.7V or $\pm 18.0\text{V}$ | 800mW                  |
| LT1213CS8 | 18.7V or $\pm 14.7\text{V}$ | 533mW                  |
| LT1214CN  | 19.5V or $\pm 15.4\text{V}$ | 1143mW                 |
| LT1214CS  | 15.8V or $\pm 12.2\text{V}$ | 800mW                  |

## APPLICATIONS INFORMATION

### Inputs

Typically at room temperature, the inputs of the LT1213/LT1214 can common mode 400mV below ground ( $V^-$ ) and to within 1.2V of the positive supply with the amplifier still functional. However, the input bias current and offset voltage will shift as shown in the characteristic curves. For full precision performance, the common mode range should be limited between ground ( $V^-$ ) and 1.5V below the positive supply.

When either of the inputs is taken below ground ( $V^-$ ) by more than about 700mV, that input current will increase dramatically. The current is limited by internal 100 $\Omega$  resistors between the input pins and diodes to each supply. The output will remain low (no phase reversal) for inputs 1.3V below ground ( $V^-$ ). If the output does not have to sink current, such as in a single supply system with a 1k load to ground, there is no phase reversal for inputs up to 8V below ground.

There are no clamps across the inputs of the LT1213/LT1214 and therefore each input can be forced to any voltage between the supplies. The input current will remain constant at about 100nA over most of this range. When an input gets closer than 1.5V to the positive supply, that input current will gradually decrease to zero until the input goes above the supply, then it will increase due to the previously mentioned diodes. If the inverting input is held more positive than the noninverting input by 200mV or more, while at the same time the noninverting input is within 300mV of ground ( $V^-$ ), then the supply current will increase by 2mA and the noninverting input current will increase to about 10 $\mu$ A. This should be kept in mind in comparator applications where the inverting input stays above ground ( $V^-$ ) and the noninverting input is at or near ground ( $V^-$ ).

### Output

The output of the LT1213/LT1214 will swing to within 0.61V of the positive supply with no load. The open-loop output resistance, when the output is driven hard into the

positive rail, is about 100 $\Omega$  as the output starts to source current; this resistance drops to about 20 $\Omega$  as the current increases. Therefore when the output sources 1mA, the output will swing to within 0.7V of the positive supply. While sourcing 30mA, it is within 1.25V of the positive supply.

The output of the LT1213/LT1214 will swing to within 4mV of the negative supply while sinking zero current. Thus, in a typical single supply application with the load going to ground, the output will go to within 4mV of ground. The open-loop output resistance when the output is driven hard into the negative rail is about 29 $\Omega$  at low currents and reduces to about 23 $\Omega$  at high currents. Therefore when the output sinks 1mA, the output is about 33mV above the negative supply and while sinking 30mA, it is about 690mV above it.

The output of the LT1213/LT1214 has reverse-biased diodes to each supply. If the output is forced beyond either supply, unlimited currents will flow. If the current is transient and limited to several hundred mA, no damage will occur.

### Feedback Components

Because the input currents of the LT1213/LT1214 are less than 200nA, it is possible to use high value feedback resistors to set the gain. However, care must be taken to insure that the pole that is formed by the feedback resistors and the input capacitance does not degrade the stability of the amplifier. For example, if a single supply, noninverting gain of two is set with two 10k resistors, the LT1213/LT1214 will probably oscillate. This is because the amplifier goes open-loop at 6MHz (6dB of gain) and has 45° of phase margin. The feedback resistors and the 10pF input capacitance generate a pole at 3MHz that introduces 63° of phase shift at 6MHz! The solution is simple, lower the values of the resistors or add a feedback capacitor of 10pF or more.

## APPLICATIONS INFORMATION

### Comparator Applications

Sometimes it is desirable to use an op amp as a comparator. When operating the LT1213/LT1214 on a single 3.3V or 5V supply, the output interfaces directly with most TTL and CMOS logic.

The response time of the LT1213/LT1214 is a strong function of the amount of input overdrive as shown in the

following photos. These amplifiers are unity-gain stable op amps and not fast comparators, therefore, the logic being driven may oscillate due to the long transition time. The output can be speeded up by adding 20mV or more of hysteresis (positive feedback), but the offset is then a function of the input direction.

**LT1213 Comparator Response (+)**  
20mV, 10mV, 5mV, 2mV Overdrives

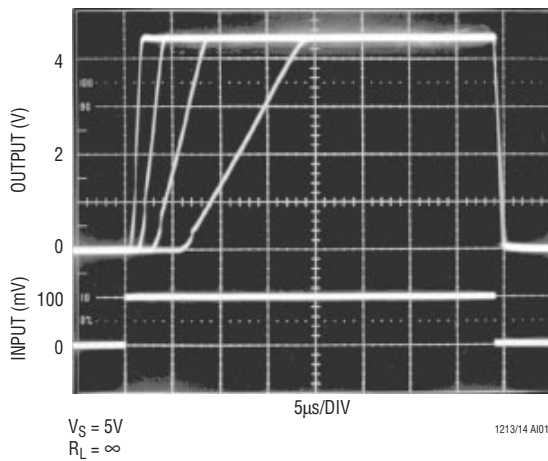

**LT1213 Comparator Response (-)**  
20mV, 10mV, 5mV, 2mV Overdrives

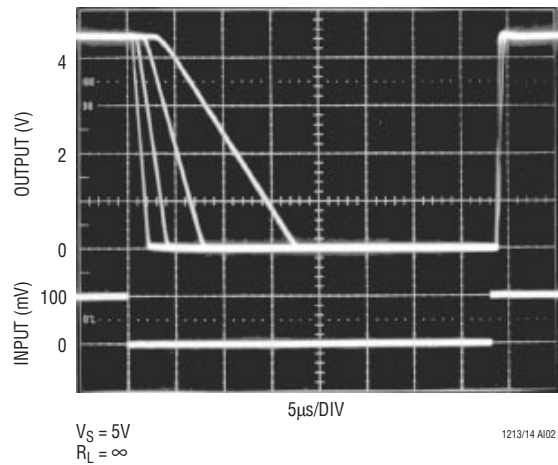

## SIMPLIFIED SCHEMATIC

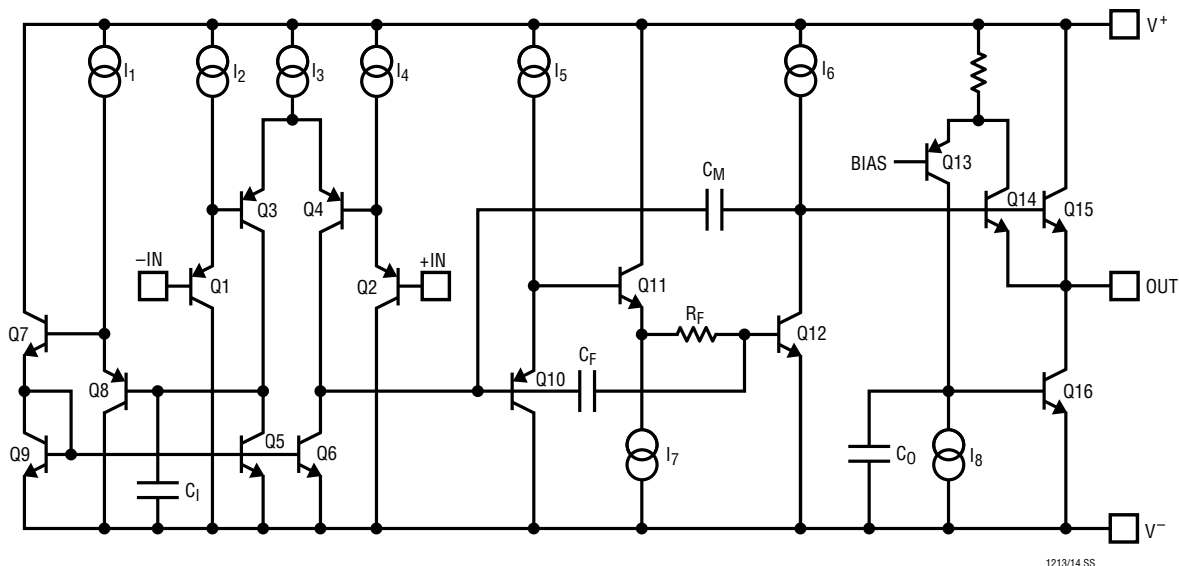

**PACKAGE DESCRIPTION**

**J8 Package**  
**8-Lead CERDIP (Narrow .300 Inch, Hermetic)**  
 (Reference LTC DWG # 05-08-1110)

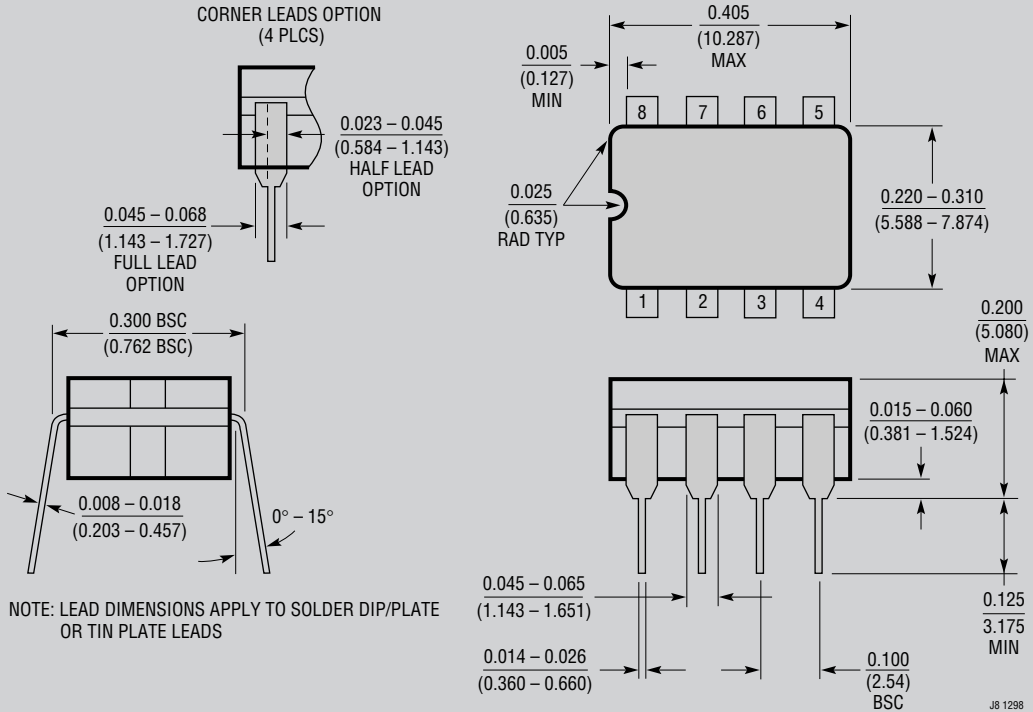

**OBsolete PACKAGE**

# PACKAGE DESCRIPTION

## N8 Package 8-Lead PDIP (Narrow .300 Inch) (Reference LTC DWG # 05-08-1510)

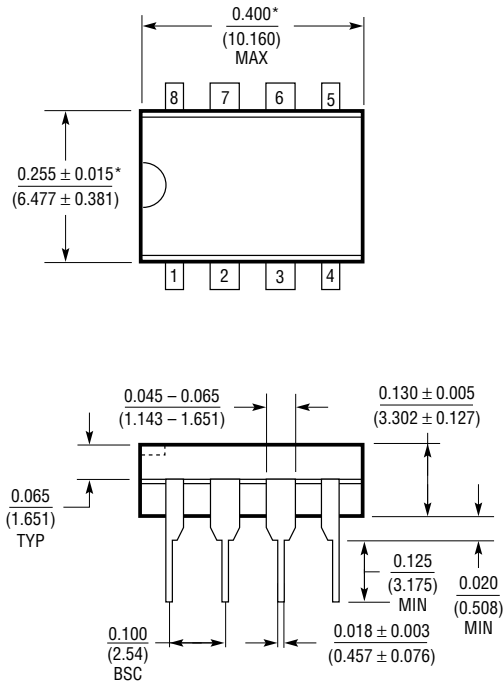

\*THESE DIMENSIONS DO NOT INCLUDE MOLD FLASH OR PROTRUSIONS.  
MOLD FLASH OR PROTRUSIONS SHALL NOT EXCEED 0.010 INCH (0.254mm)

N8 1098

## N Package 14-Lead PDIP (Narrow .300 Inch) (Reference LTC DWG # 05-08-1510)

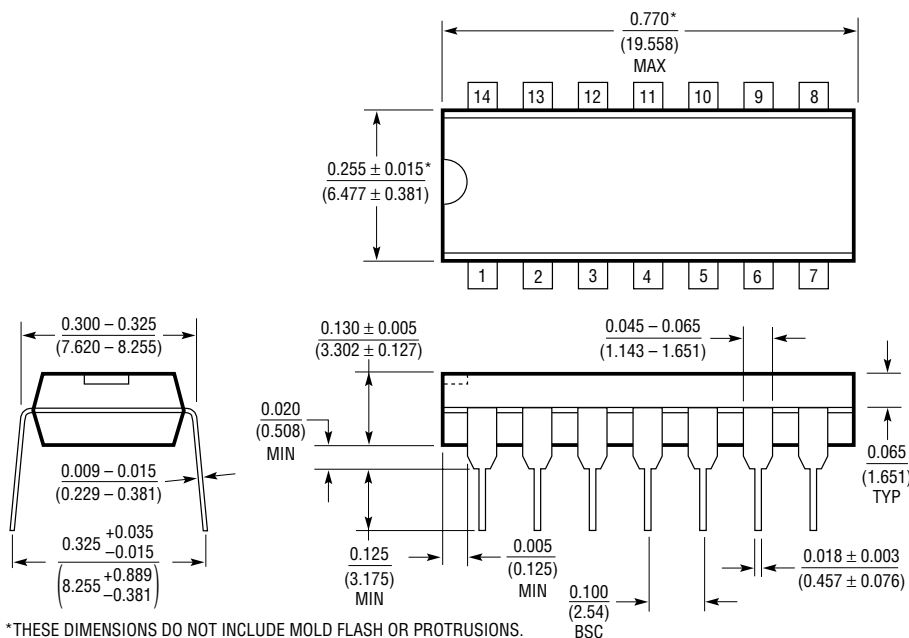

\*THESE DIMENSIONS DO NOT INCLUDE MOLD FLASH OR PROTRUSIONS.  
MOLD FLASH OR PROTRUSIONS SHALL NOT EXCEED 0.010 INCH (0.254mm)

N14 1098

**PACKAGE DESCRIPTION**

**S8 Package**  
**8-Lead Plastic Small Outline (Narrow .150 Inch)**  
 (Reference LTC DWG # 05-08-1610)

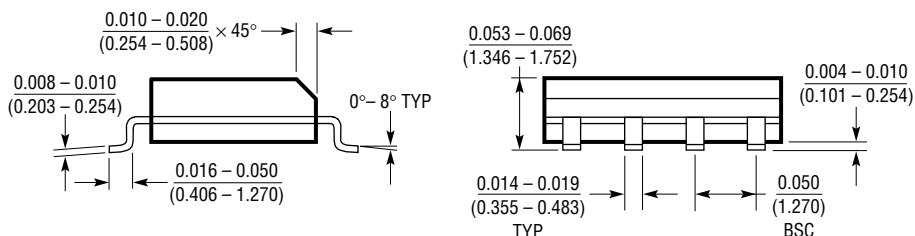
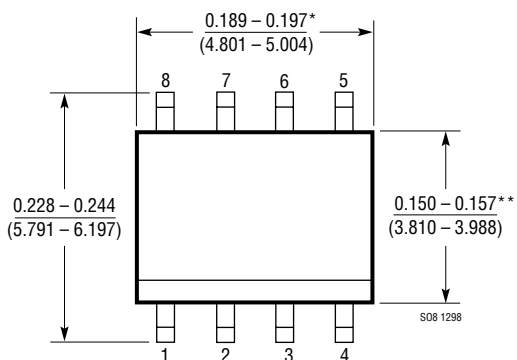

\*DIMENSION DOES NOT INCLUDE MOLD FLASH. MOLD FLASH SHALL NOT EXCEED 0.006" (0.152mm) PER SIDE  
 \*\*DIMENSION DOES NOT INCLUDE INTERLEAD FLASH. INTERLEAD FLASH SHALL NOT EXCEED 0.010" (0.254mm) PER SIDE

**PACKAGE DESCRIPTION**

**S Package**  
**16-Lead Plastic Small Outline (Narrow .150 Inch)**  
 (Reference LTC DWG # 05-08-1610)

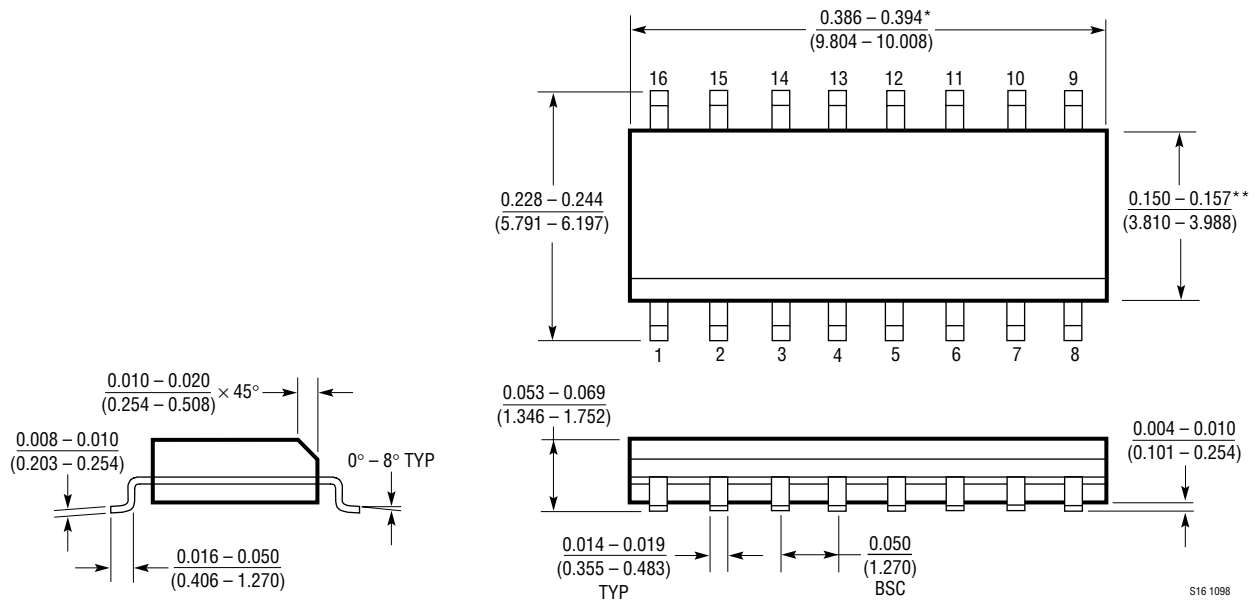

\*DIMENSION DOES NOT INCLUDE MOLD FLASH. MOLD FLASH SHALL NOT EXCEED 0.006" (0.152mm) PER SIDE

\*\*DIMENSION DOES NOT INCLUDE INTERLEAD FLASH. INTERLEAD FLASH SHALL NOT EXCEED 0.010" (0.254mm) PER SIDE

S16 1098

## TYPICAL APPLICATIONS

### Instrumentation Amplifier with Guard/Shield Driver and Input Bias Current Cancellation

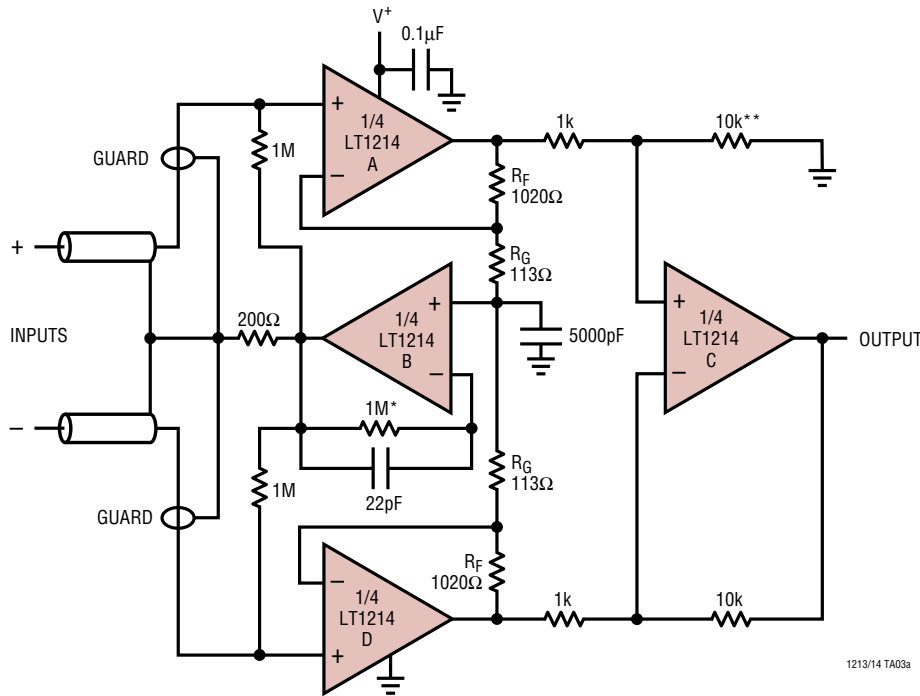

COMMON MODE  $R_{IN} = 3G$   
 DIFFERENTIAL  $R_{IN} = 2M$   
 BANDWIDTH = 2MHz  
 $t_r = 170ns$

$$GAIN = 10 \left( 1 + \frac{R_F}{R_G} \right) = 100$$

\* TRIM FOR INPUT BIAS CURRENT  
 \*\* TRIM FOR CMRR

Input Bias Current vs Common Mode Voltage

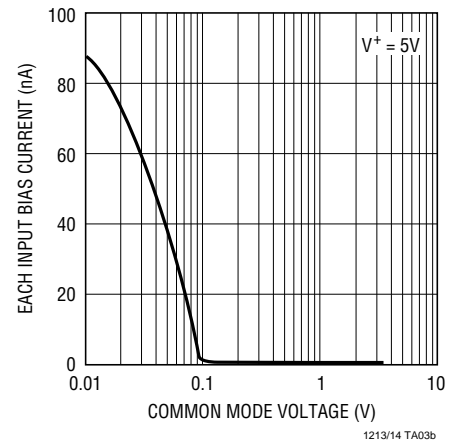

### Ground Current Sense Amplifier

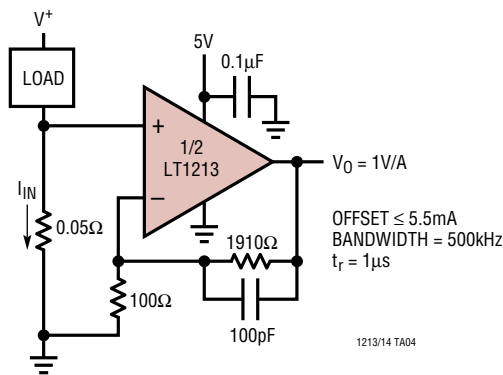

1213/14 TA04

### Difference Amplifier with Wide Input Common Mode Range

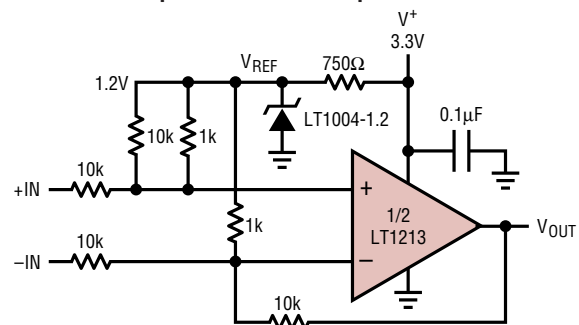

GAIN = 1;  $V_{OUT} = V_{REF}$  FOR  $V_{IN(DIF)} = 0$   
 $\pm 10V$  COMMON MODE RANGE  
 BANDWIDTH = 3MHz

1213/14 TA05

## RELATED PARTS

| PART NUMBER   | DESCRIPTION   | COMMENTS                               |
|---------------|---|--|
| LT1211/LT1212 | 14MHz, 7V/ $\mu$ s Single Supply Dual and Quad Precision Op Amps                  | Half the Supply Current of the LT1213  |
| LT1215/LT1216 | 23MHz, 50V/ $\mu$ s Single Supply Dual and Quad Precision Op Amps                 | Four Times the Slew Rate of the LT1213 |
| LT1630/LT1631 | 30MHz, 10V/ $\mu$ s Dual and Quad Rail-to-Rail Input and Output Precision Op Amps | Rail-to-Rail LT1213                    |

## Looking for pricing, stock, or lifecycle information?

Click below to explore more details on WIN SOURCE:

 [View LT1213CS8#TRPBF on WIN SOURCE](#)

 [Linear Technology](#) Information

## Optimize Your Supply Chain with WIN SOURCE Solutions

-  Global Sourcing Solution
-  Obsolete Management
-  Cost Control Management
-  Shortage Management
-  Alternative Solution
-  Excess Inventory Management