

LT1□□67A series

1616 Size, 0.8mm Thickness, Compact Dichromatic Leadless Chip LED

Outline Dimensions

(Unit : mm)

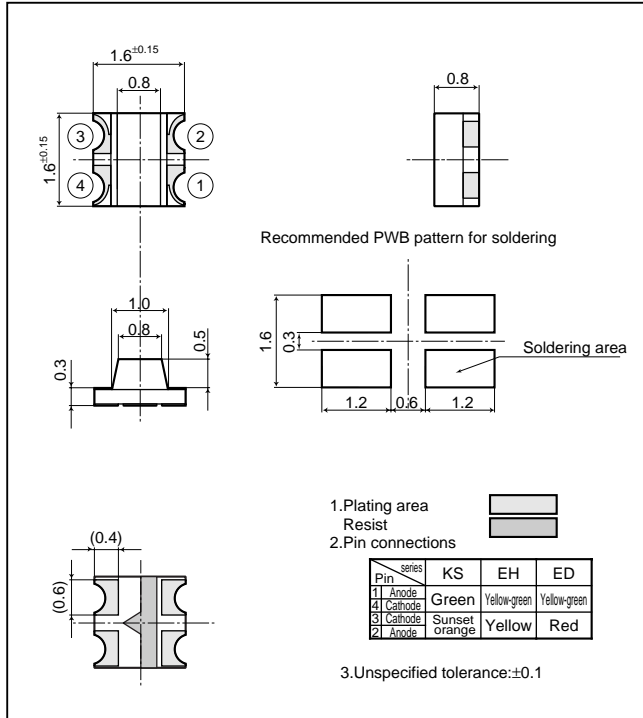

Directive Characteristics

(Ta=25°C)

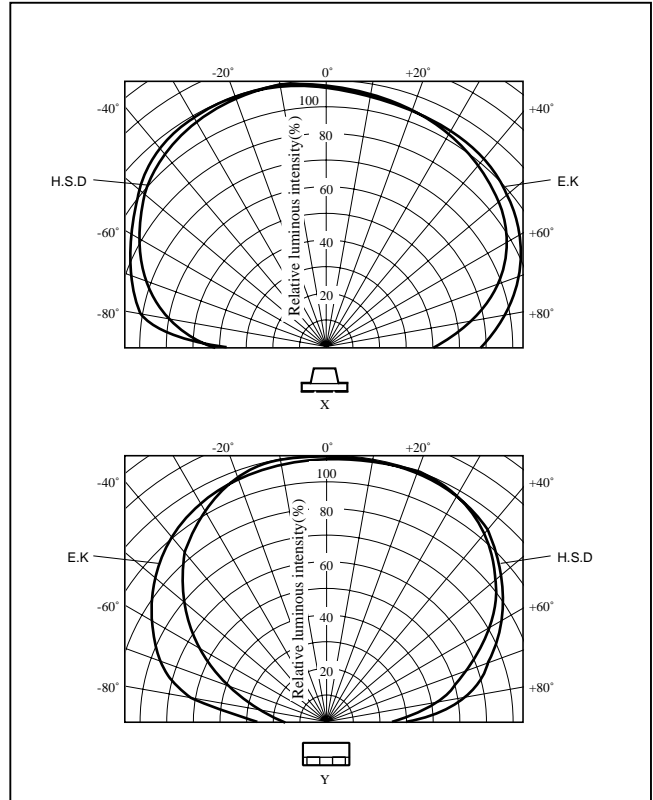

Absolute Maximum Ratings^{*1}

(Ta=25°C)

Model No.	Emitting color	Material	Power dissipation P (mW)	Forward current I _F (mA)	Peak forward current I _{FM} ^{*2} (mA)	Derating factor (mA/°C)		Reverse voltage V _R (V)	Operating temperature T _{opr} (°C)	Storage temperature T _{stg} (°C)	Soldering temperature T _{sol} ^{*3} (°C)
						DC	Pulse				
LT1EH67A	Yellow-green	GaP	84	30	50	0.40	0.67	5	-30 to +85	-40 to +100	350
	Yellow	GaAsP on GaP	84	30	50	0.40	0.67	5	-30 to +85	-40 to +100	350
LT1KS67A	Green	GaP	84	30	50	0.40	0.67	5	-30 to +85	-40 to +100	350
	Sunset orange	GaAsP on GaP	84	30	50	0.40	0.67	5	-30 to +85	-40 to +100	350
LT1ED67A	Yellow-green	GaP	84	30	50	0.40	0.67	5	-30 to +85	-40 to +100	350
	Red	GaAsP on GaP	84	30	50	0.40	0.67	5	-30 to +85	-40 to +100	350

*1 The value is specified under the condition that either color is lightened separately. When the both diodes are lightened simultaneously, the power dissipation of each diode should be less than the half of the value specified in this table.

*2 Duty ratio=1/10, Pulse width=0.1ms

*3 For 3s or less at the temperature of hand soldering. Temperature of reflow soldering is shown on page 2.

Electro-optical Characteristics

(Ta=25°C)

Lens type	Model No.	Radiation color	Forward voltage V _F (V)		Peak emission wavelength λ _p (nm)		Luminous intensity I _v (mcd)		Spectrum radiation bandwidth Δλ(nm)		Reverse current I _R (μA)		Terminal capacitance C _t (pF)		Page for characteristics diagrams
			TYP	MAX	TYP	I _F (mA)	TYP	I _F (mA)	TYP	I _F (mA)	MAX	V _R (V)	TYP	(MHz)	
Milky diffusion	LT1EH67A	Yellow-green	2.1	2.8	565	20	19.0	20	30	20	10	4	35	1	59
		Yellow	2.0	2.8	585	20	8.3	20	30	20	10	4	35	1	58
	LT1KS67A	Green	2.1	2.8	555	20	3.8	20	25	20	10	4	40	1	59
		Sunset orange	2.0	2.8	610	20	6.9	20	35	20	10	4	15	1	58
	LT1ED67A	Yellow-green	2.1	2.8	565	20	19.0	20	30	20	10	4	35	1	59
		Red	2.0	2.8	635	20	8.8	20	35	20	10	4	20	1	57

Characteristics Diagrams

PR,P series

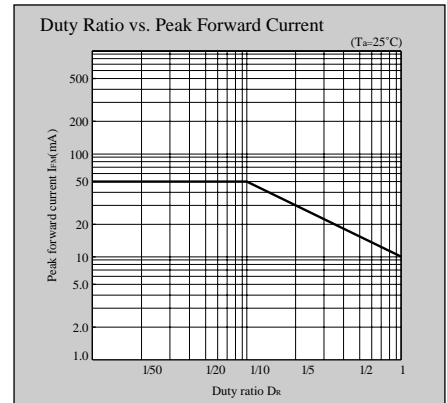
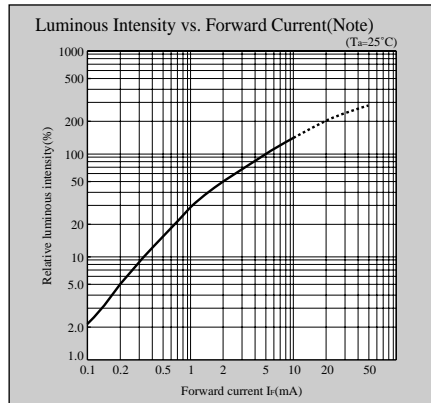
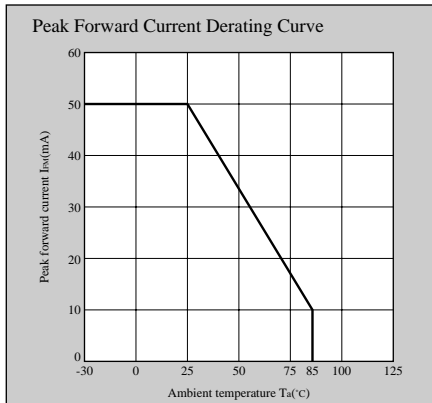
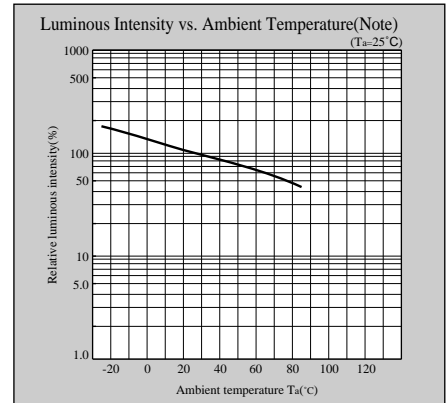
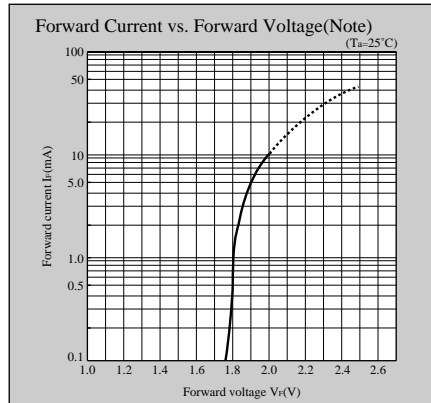
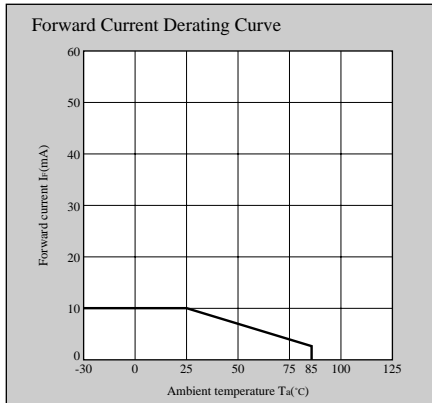

HD,D series

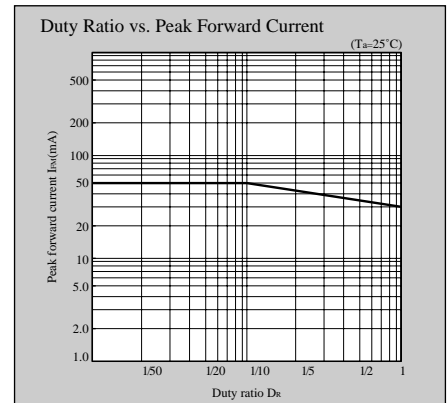
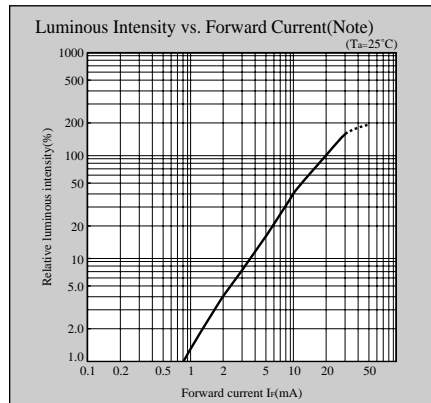
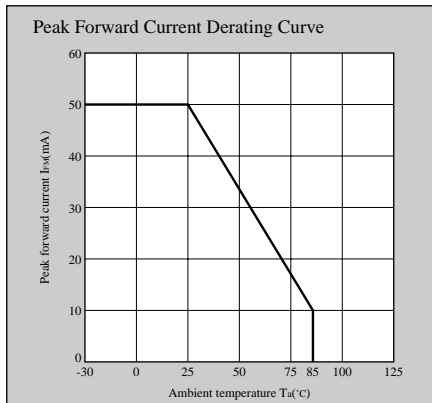
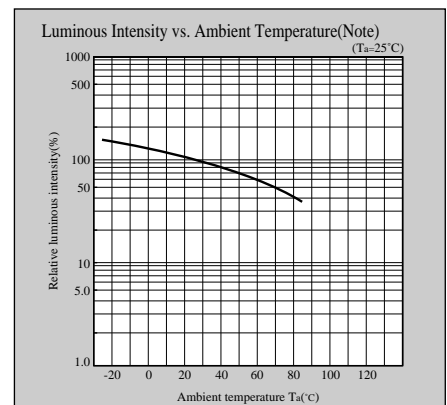
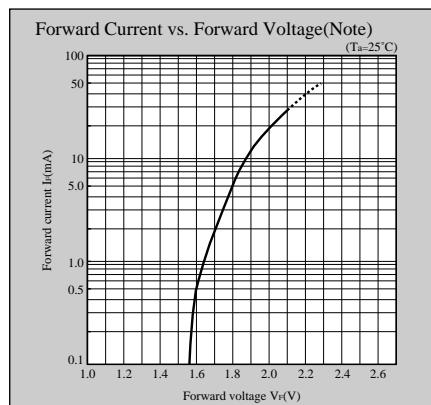
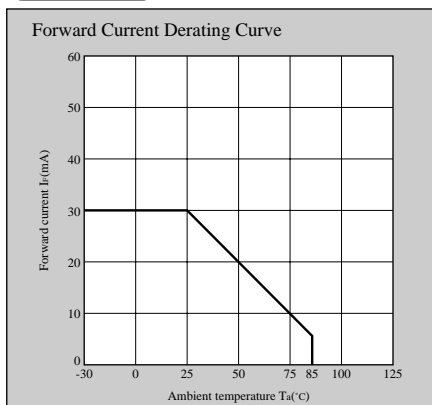

Note) Characteristics shown in diagrams are typical values. (not assurance value)

Notice In the absence of confirmation by device specification sheets, SHARP takes no responsibility for any defects that may occur in equipment using any SHARP devices shown in catalogs, data books, etc. Contact SHARP in order to obtain the latest device specification sheets before using any SHARP device.

Internet Internet address for Electronic Components Group <http://sharp-world.com/ecg>

Characteristics Diagrams

HS,S series

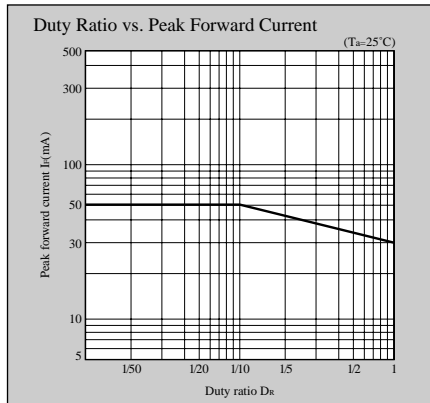
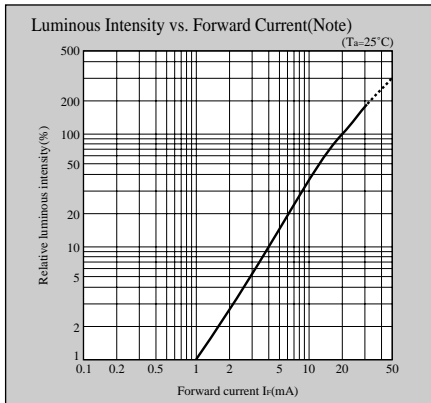
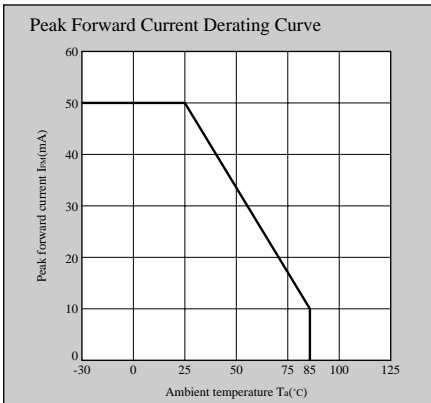
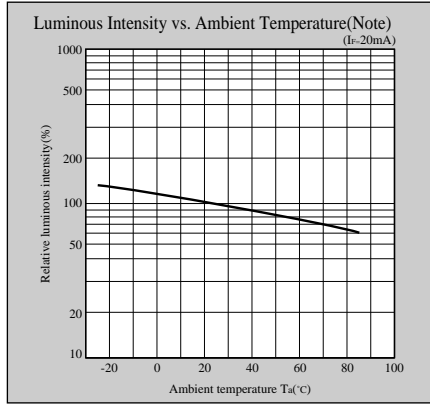
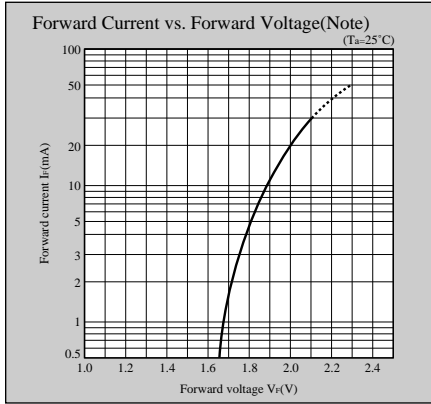
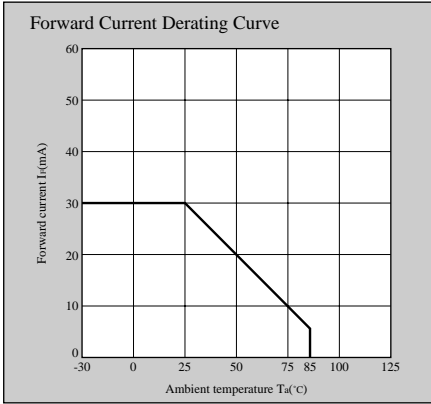

HY,H series

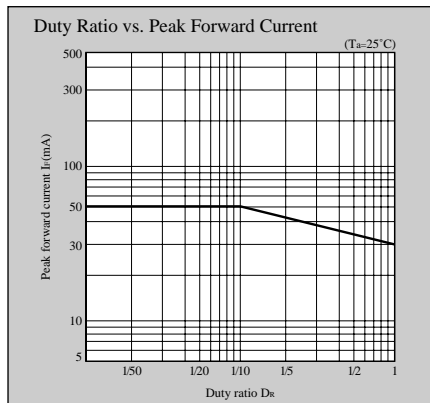
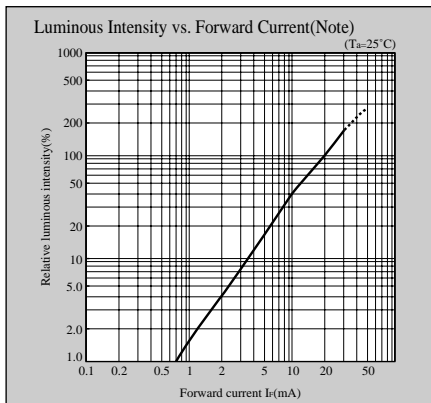
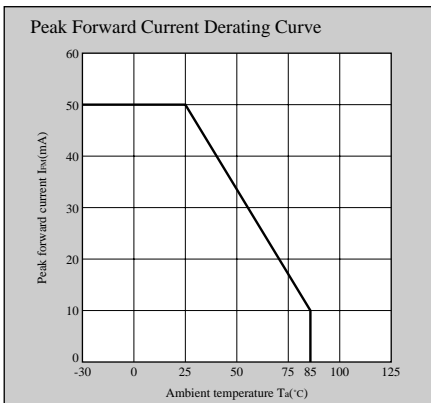
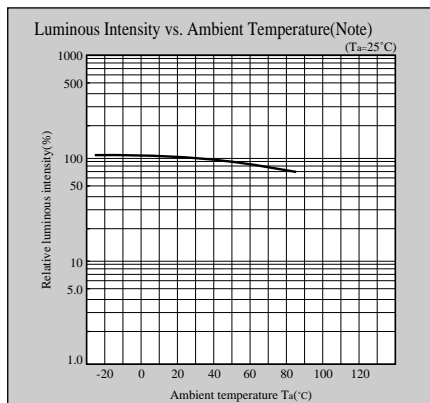
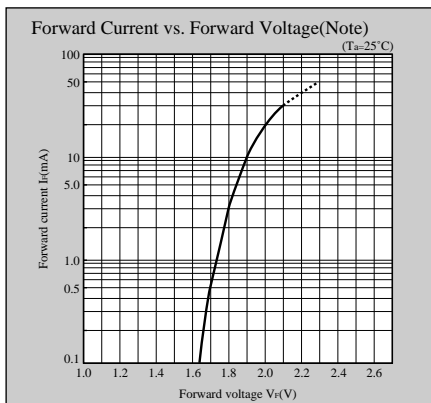
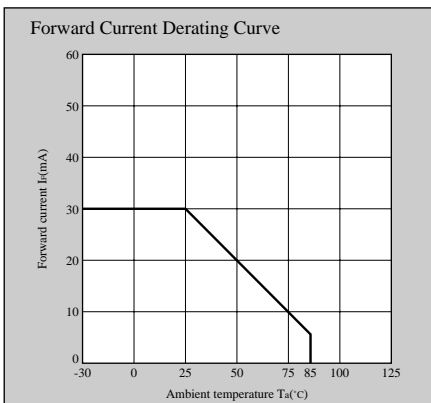

Note) Characteristics shown in diagrams are typical values. (not assurance value)

Characteristics Diagrams

EG,E,F series

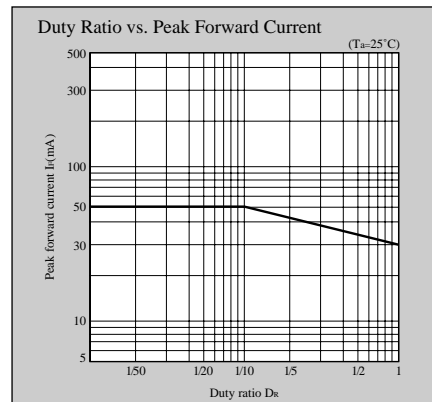
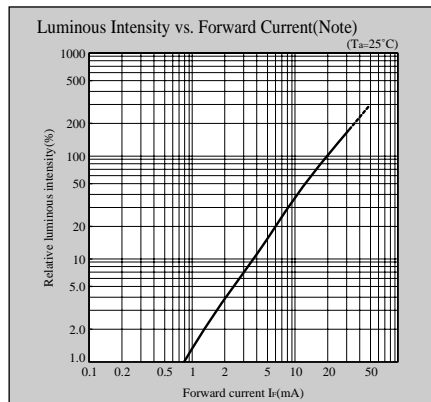
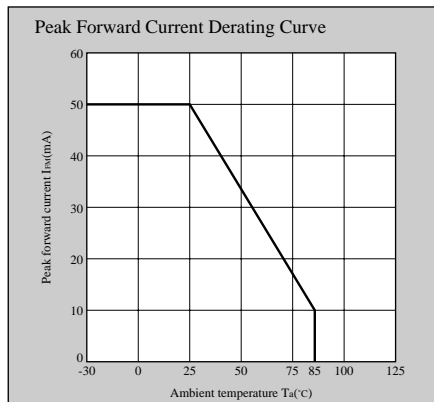
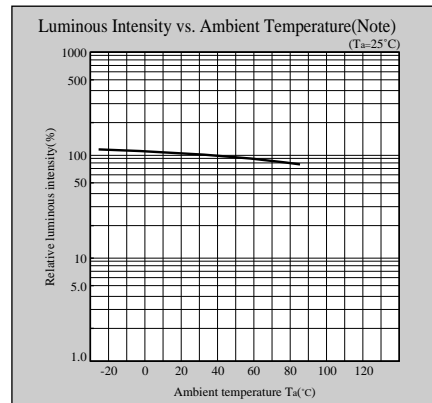
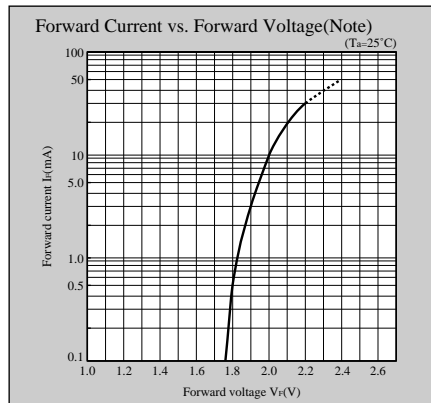
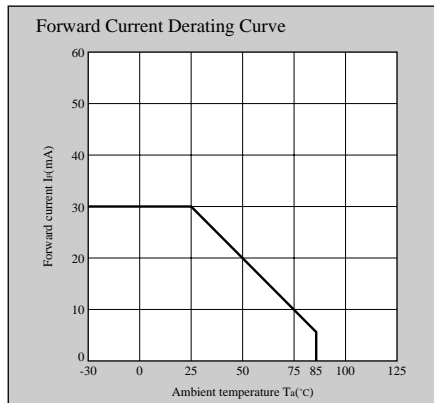

KG,K series

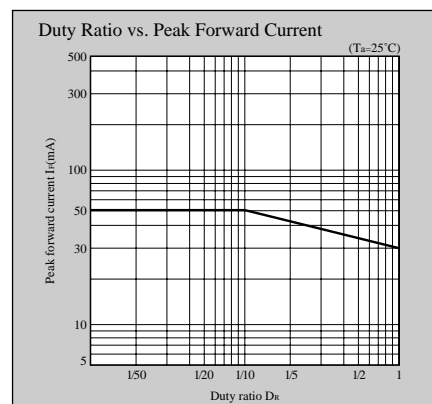
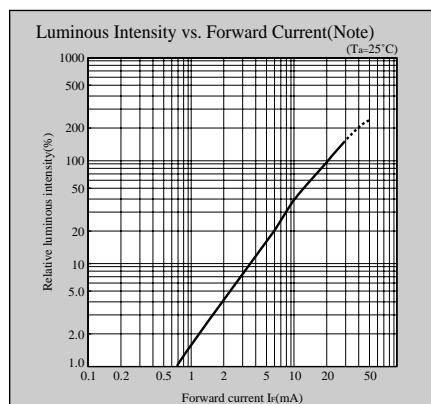
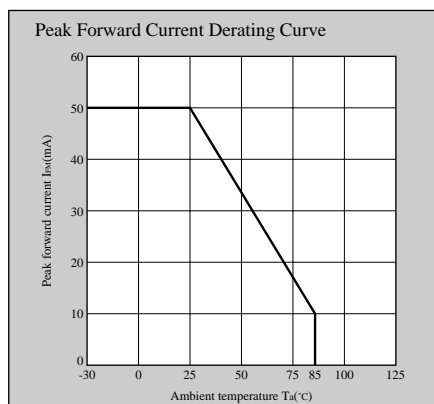
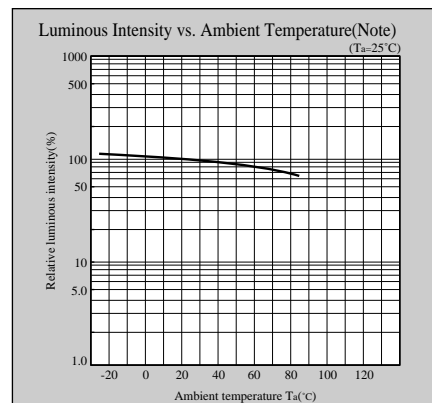
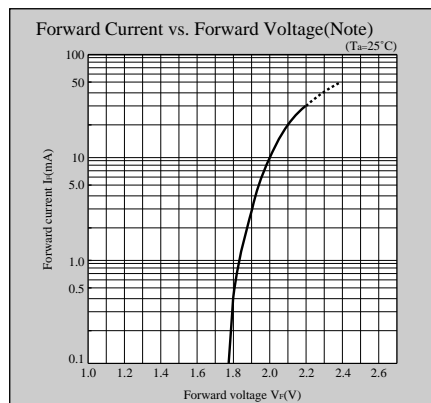
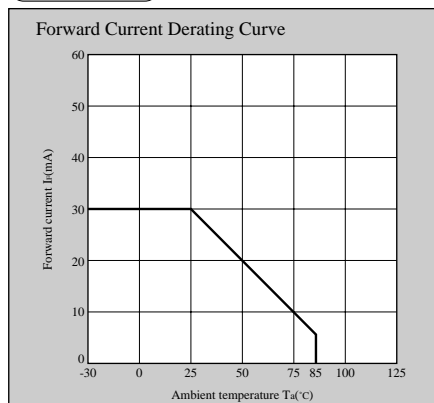

Note) Characteristics shown in diagrams are typical values. (not assurance value)

Taping Specifications

(Unit : mm)

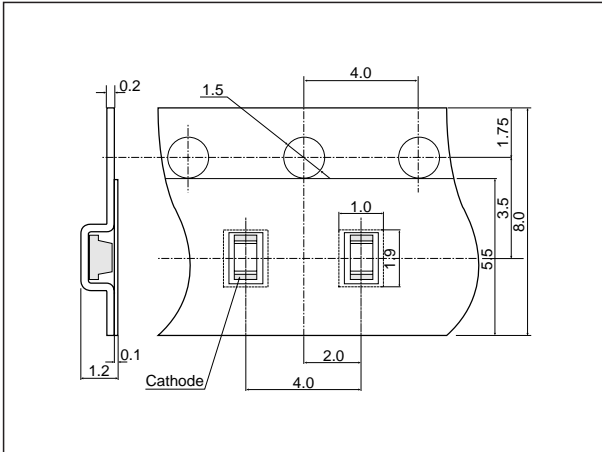

GM1□□35200A□ series 6 000 pcs. /reel
 GM1□□55200A□ series 5 000 pcs. /reel
 LT1□□67A series 4 000 pcs. /reel
 LT1□□97A series 5 000 pcs. /reel

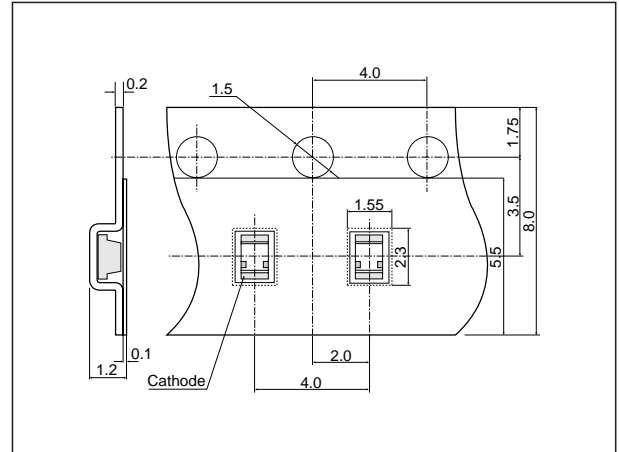

GM1□□40300AE series/LT1□□40A series 4 000 pcs. /reel

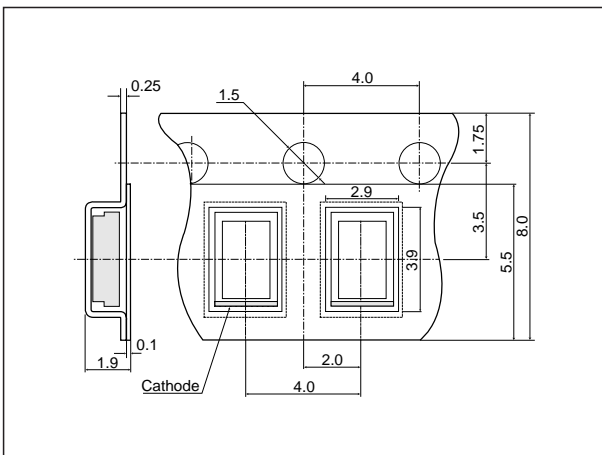

LT1□□90A series 3 000 pcs. /reel

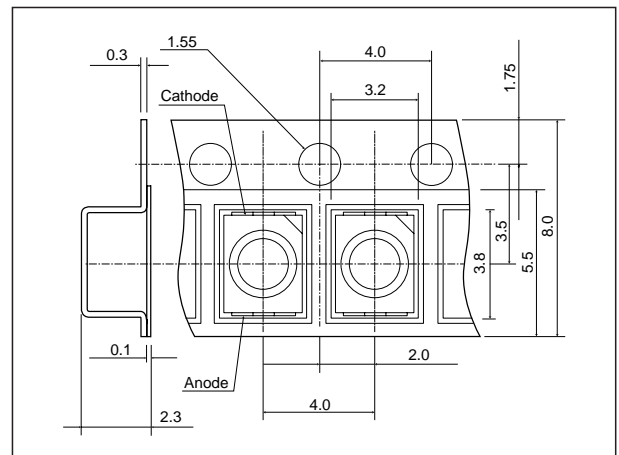

GM5□□95200A□ series/LT1Z□□95A series 2 000 pcs. /reel

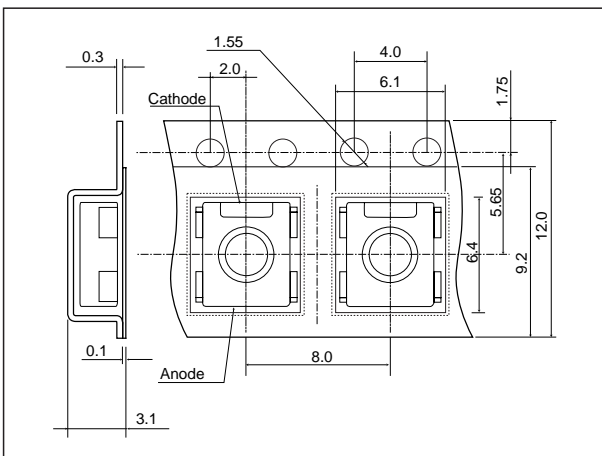

GM5□□01200A series/GM5WA02200A/GM5WA06210A/
 GM5WA06250A 800 pcs. /reel

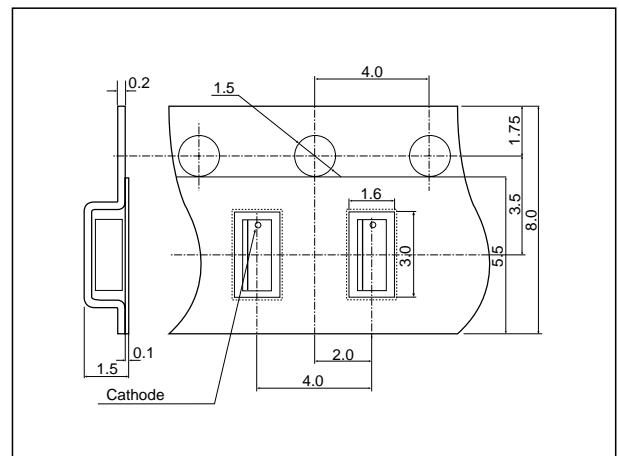

LT1□□45A series/GM4□□C13300AC series 3 000 pcs. /reel

Taping Specifications

■Lead type Chip LED (Unit : mm)

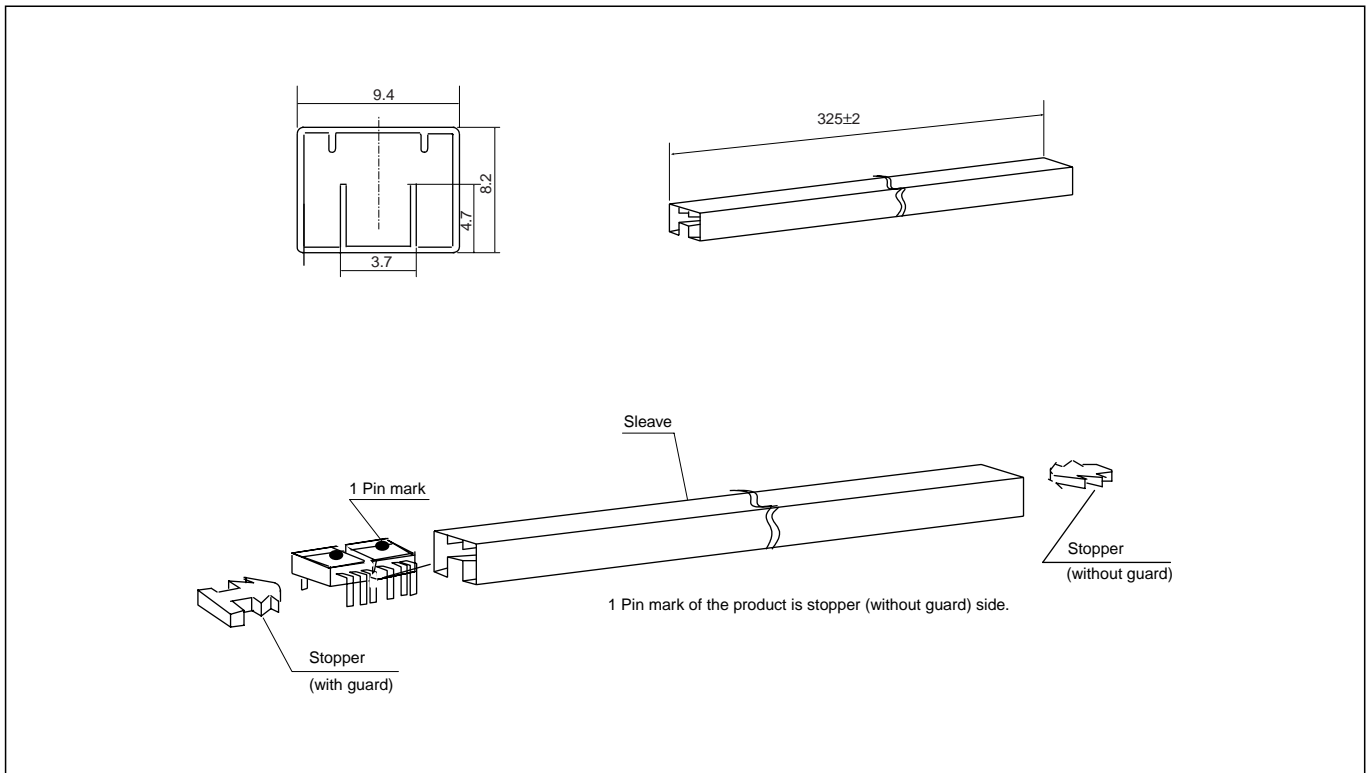



GM5□□03200Z series/GM5WA06200Z/GM5WA06250Z 1 000 pcs. (50 pcs./sleeve × 20)

NOTICE







- The circuit application examples in this publication are provided to explain representative applications of SHARP devices and are not intended to guarantee any circuit design or license any intellectual property rights. SHARP takes no responsibility for any problems related to any intellectual property right of a third party resulting from the use of SHARP's devices.
- Contact SHARP in order to obtain the latest device specification sheets before using any SHARP device. SHARP reserves the right to make changes in the specifications, characteristics, data, materials, structure, and other contents described herein at any time without notice in order to improve design or reliability. Manufacturing locations are also subject to change without notice.
- Observe the following points when using any devices in this publication. SHARP takes no responsibility for damage caused by improper use of the devices which does not meet the conditions and absolute maximum ratings to be used specified in the relevant specification sheet nor meet the following conditions:
 - (i) The devices in this publication are designed for use in general electronic equipment designs such as:
 - Personal computers
 - Office automation equipment
 - Telecommunication equipment [terminal]
 - Test and measurement equipment
 - Industrial control
 - Audio visual equipment
 - Consumer electronics
 - (ii) Measures such as fail-safe function and redundant design should be taken to ensure reliability and safety when SHARP devices are used for or in connection with equipment that requires higher reliability such as:
 - Transportation control and safety equipment (i.e., aircraft, trains, automobiles, etc.)
 - Traffic signals
 - Gas leakage sensor breakers
 - Alarm equipment
 - Various safety devices, etc.
 - (iii) SHARP devices shall not be used for or in connection with equipment that requires an extremely high level of reliability and safety such as:
 - Space applications
 - Telecommunication equipment [trunk lines]
 - Nuclear power control equipment
 - Medical and other life support equipment (e.g., scuba).
- If the SHARP devices listed in this publication fall within the scope of strategic products described in the Foreign Exchange and Foreign Trade Law of Japan, it is necessary to obtain approval to export such SHARP devices.
- This publication is the proprietary product of SHARP and is copyrighted, with all rights reserved. Under the copyright laws, no part of this publication may be reproduced or transmitted in any form or by any means, electronic or mechanical, for any purpose, in whole or in part, without the express written permission of SHARP. Express written permission is also required before any use of this publication may be made by a third party.
- Contact and consult with a SHARP representative if there are any questions about the contents of this publication.

Looking for pricing, stock, or lifecycle information?

Click below to explore more details on WIN SOURCE:

-  [View LT1EH67A on WIN SOURCE](#)
-  [Sharp Microelectronics](#) Information

Optimize Your Supply Chain with WIN SOURCE Solutions

-  Global Sourcing Solution
-  Obsolete Management
-  Cost Control Management
-  Shortage Management
-  Alternative Solution
-  Excess Inventory Management