



**THE DATASHEET OF  
LT3024EFE#PBF**



# Dual 100mA/500mA Low Dropout, Low Noise, Micropower Regulator

## FEATURES

- **Low Noise:** 20 $\mu$ V<sub>RMS</sub> (10Hz to 100kHz)
- **Low Quiescent Current:** 30 $\mu$ A/Output
- **Wide Input Voltage Range:** 1.8V to 20V
- **Output Current:** 100mA/500mA
- **Very Low Shutdown Current:** <0.1 $\mu$ A
- **Low Dropout Voltage:** 300mV at 100mA/500mA
- Adjustable Outputs from 1.22V to 20V
- Stable with 1 $\mu$ F/3.3 $\mu$ F Output Capacitor
- Stable with Aluminum, Tantalum or Ceramic Capacitors
- Reverse Battery Protected
- No Reverse Current
- No Protection Diodes Needed
- Overcurrent and Overtemperature Protected
- Thermally Enhanced 16-Lead TSSOP and 12-Lead (4mm  $\times$  3mm) DFN Packages

## APPLICATIONS

- Cellular Phones
- Pagers
- Battery-Powered Systems
- Frequency Synthesizers
- Wireless Modems

 LT, LTC and LTM are registered trademarks of Linear Technology Corporation. All other trademarks are the property of their respective owners.

## DESCRIPTION

The LT<sup>®</sup>3024 is a dual, micropower, low noise, low dropout regulator. With an external 0.01 $\mu$ F bypass capacitor, output noise drops to 20 $\mu$ V<sub>RMS</sub> over a 10Hz to 100kHz bandwidth. Designed for use in battery-powered systems, the low 30 $\mu$ A quiescent current per output makes it an ideal choice. In shutdown, quiescent current drops to less than 0.1 $\mu$ A. Shutdown control is independent for each output, allowing for flexibility in power management. The device is capable of operating over an input voltage range of 1.8V to 20V. The device can supply 100mA of output current from Output 2 with a dropout voltage of 300mV. Output 1 can supply 500mA of output current with a dropout voltage of 300mV. Quiescent current is well controlled in dropout.

The LT3024 regulator is stable with output capacitors as low as 1 $\mu$ F for the 100mA output and 3.3 $\mu$ F for the 500mA output. Small ceramic capacitors can be used without the series resistance required by other regulators.

Internal protection circuitry includes reverse-battery protection, current limiting, thermal limiting and reverse current protection. The device is available as an adjustable device with a 1.22V reference voltage. The LT3024 regulator is available in the thermally enhanced 16-lead TSSOP and 12-lead, low profile (4mm  $\times$  3mm  $\times$  0.75mm) DFN packages.

## TYPICAL APPLICATION

3.3V/2.5V Low Noise Regulators

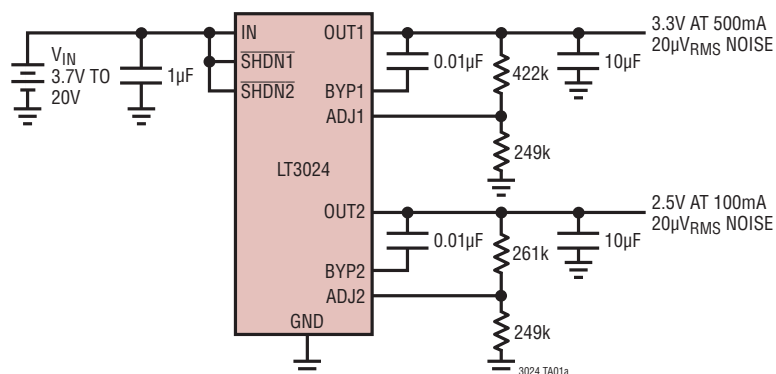

10Hz to 100kHz Output Noise

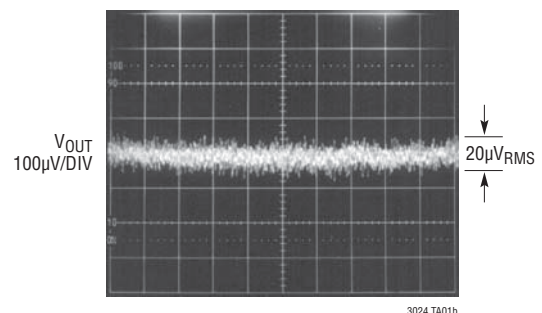

## ABSOLUTE MAXIMUM RATINGS

(Note 1)

IN Pin Voltage .....	±20V
OUT1, OUT2 Pin Voltage .....	±20V
Input-to-Output Differential Voltage .....	±20V
ADJ1, ADJ2 Pin Voltage .....	±7V
BYP1, BYP2 Pin Voltage .....	±0.6V
SHDN1, SHDN2 Pin Voltage .....	±20V
Output Short-Circuit Duration .....	Indefinite

Operating Junction Temperature Range	
(Note 2) .....	−40°C to 125°C
Storage Temperature Range	
FE Package .....	−65°C to 150°C
DE Package .....	−65°C to 125°C
Lead Temperature (Soldering, 10 sec) .....	300°C
(FE package only)	

## PIN CONFIGURATION

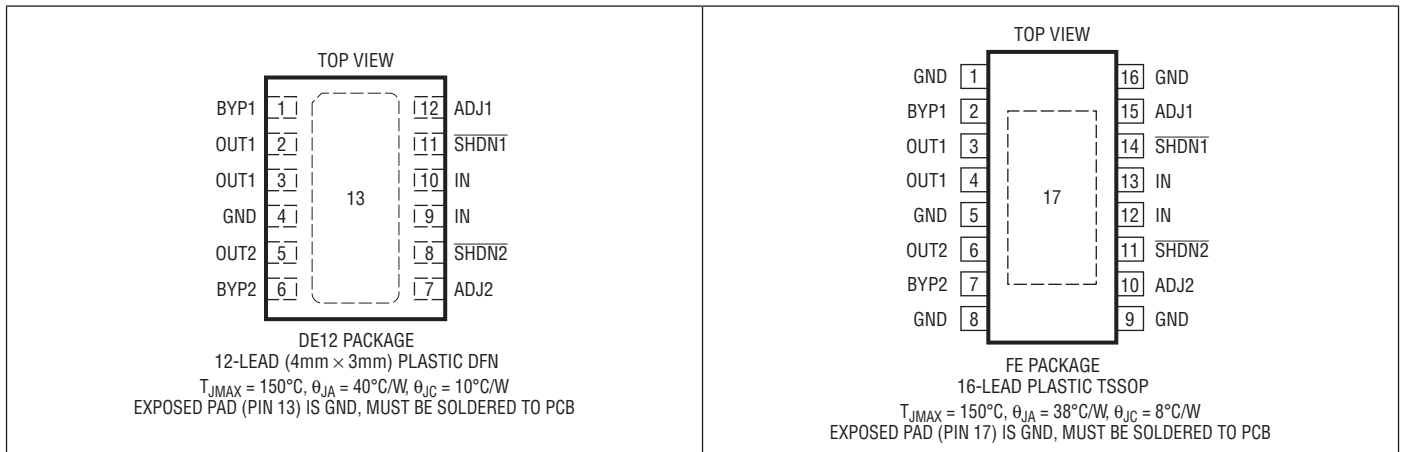

## ORDER INFORMATION

LEAD FREE FINISH	TAPE AND REEL	PART MARKING*	PACKAGE DESCRIPTION	TEMPERATURE RANGE
LT3024EDE#PBF	LT3024EDE#TRPBF	3024	12-Lead (4mm × 3mm) Plastic DFN	−40°C to 125°C
LT3024IDE#PBF	LT3024IDE#TRPBF	3024	12-Lead (4mm × 3mm) Plastic DFN	−40°C to 125°C
LT3024EFE#PBF	LT3024EFE#TRPBF	3024EFE	16-Lead Plastic TSSOP	−40°C to 125°C
LT3024IFE#PBF	LT3024IFE#TRPBF	3024IFE	16-Lead Plastic TSSOP	−40°C to 125°C
LEAD BASED FINISH	TAPE AND REEL	PART MARKING*	PACKAGE DESCRIPTION	TEMPERATURE RANGE
LT3024EDE	LT3024EDE#TR	3024	12-Lead (4mm × 3mm) Plastic DFN	−40°C to 125°C
LT3024IDE	LT3024IDE#TR	3024	12-Lead (4mm × 3mm) Plastic DFN	−40°C to 125°C
LT3024EFE	LT3024EFE#TR	3024EFE	16-Lead Plastic TSSOP	−40°C to 125°C
LT3024IFE	LT3024IFE#TR	3024IFE	16-Lead Plastic TSSOP	−40°C to 125°C

Consult LTC Marketing for parts specified with wider operating temperature ranges. \*The temperature grade is identified by a label on the shipping container.

For more information on lead free part marking, go to: <http://www.linear.com/leadfree/>

For more information on tape and reel specifications, go to: <http://www.linear.com/tapeandreel/>

**ELECTRICAL CHARACTERISTICS** The ● denotes the specifications which apply over the full operating temperature range, otherwise specifications are at  $T_A = 25^\circ\text{C}$ . (Note 2)

PARAMETER	CONDITIONS		MIN	TYP	MAX	UNITS
Minimum Input Voltage (Notes 3, 11)	Output 2, $I_{LOAD} = 100\text{mA}$	●		1.8	2.3	V
	Output 1, $I_{LOAD} = 500\text{mA}$	●		1.8	2.3	V
ADJ1, ADJ2 Pin Voltage (Note 3, 4)	$V_{IN} = 2\text{V}$ , $I_{LOAD} = 1\text{mA}$		1.205	1.220	1.235	V
	Output 2, $2.3\text{V} < V_{IN} < 20\text{V}$ , $1\text{mA} < I_{LOAD} < 100\text{mA}$	●	1.190	1.220	1.250	V
	Output 1, $2.3\text{V} < V_{IN} < 20\text{V}$ , $1\text{mA} < I_{LOAD} < 500\text{mA}$	●	1.190	1.220	1.250	V
Line Regulation (Note 3)	$\Delta V_{IN} = 2\text{V}$ to $20\text{V}$ , $I_{LOAD} = 1\text{mA}$	●		1	10	mV
Load Regulation (Note 3)	Output 2, $V_{IN} = 2.3\text{V}$ , $\Delta I_{LOAD} = 1\text{mA}$ to $100\text{mA}$			1	12	mV
	$V_{IN} = 2.3\text{V}$ , $\Delta I_{LOAD} = 1\text{mA}$ to $100\text{mA}$	●			25	mV
	Output 1, $V_{IN} = 2.3\text{V}$ , $\Delta I_{LOAD} = 1\text{mA}$ to $500\text{mA}$			1	12	mV
	$V_{IN} = 2.3\text{V}$ , $\Delta I_{LOAD} = 1\text{mA}$ to $500\text{mA}$	●			25	mV
Dropout Voltage (Output 2) $V_{IN} = V_{OUT(NOMINAL)}$ (Notes 5, 6, 11)	$I_{LOAD} = 1\text{mA}$			0.10	0.15	V
	$I_{LOAD} = 1\text{mA}$	●			0.19	V
	$I_{LOAD} = 10\text{mA}$			0.17	0.22	V
	$I_{LOAD} = 10\text{mA}$	●			0.29	V
	$I_{LOAD} = 50\text{mA}$			0.24	0.31	V
	$I_{LOAD} = 50\text{mA}$	●			0.40	V
	$I_{LOAD} = 100\text{mA}$			0.30	0.35	V
	$I_{LOAD} = 100\text{mA}$	●			0.45	V
Dropout Voltage (Output 1) $V_{IN} = V_{OUT(NOMINAL)}$ (Notes 5, 6, 11)	$I_{LOAD} = 10\text{mA}$			0.13	0.19	V
	$I_{LOAD} = 10\text{mA}$	●			0.25	V
	$I_{LOAD} = 50\text{mA}$			0.17	0.22	V
	$I_{LOAD} = 50\text{mA}$	●			0.32	V
	$I_{LOAD} = 100\text{mA}$			0.20	0.34	V
	$I_{LOAD} = 100\text{mA}$	●			0.44	V
	$I_{LOAD} = 500\text{mA}$			0.30	0.35	V
	$I_{LOAD} = 500\text{mA}$	●			0.45	V
GND Pin Current (Output 2) $V_{IN} = V_{OUT(NOMINAL)}$ (Notes 5, 7)	$I_{LOAD} = 0\text{mA}$	●		20	45	$\mu\text{A}$
	$I_{LOAD} = 1\text{mA}$	●		55	90	$\mu\text{A}$
	$I_{LOAD} = 10\text{mA}$	●		230	400	$\mu\text{A}$
	$I_{LOAD} = 50\text{mA}$	●		1	2	mA
	$I_{LOAD} = 100\text{mA}$	●		2.2	4	mA
GND Pin Current (Output 1) $V_{IN} = V_{OUT(NOMINAL)}$ (Notes 5, 7)	$I_{LOAD} = 0\text{mA}$	●		30	75	$\mu\text{A}$
	$I_{LOAD} = 1\text{mA}$	●		65	120	$\mu\text{A}$
	$I_{LOAD} = 50\text{mA}$	●		1.1	1.6	mA
	$I_{LOAD} = 100\text{mA}$	●		2	3	mA
	$I_{LOAD} = 250\text{mA}$	●		5	8	mA
	$I_{LOAD} = 500\text{mA}$	●		11	16	mA
Output Voltage Noise	$C_{OUT} = 10\mu\text{F}$ , $C_{BYP} = 0.01\mu\text{F}$ , $I_{LOAD} = \text{Full Current}$ , $BW = 10\text{Hz}$ to $100\text{kHz}$			20		$\mu\text{VRMS}$
ADJ Pin Bias Current	ADJ1, ADJ2 (Notes 3, 8)			30	100	nA
Shutdown Threshold	$V_{OUT} = \text{Off to On}$	●		0.8	1.4	V
	$V_{OUT} = \text{On to Off}$	●	0.25	0.65		V
SHDN1/SHDN2 Pin Current (Note 9)	$V_{SHDN1}, V_{SHDN2} = 0\text{V}$	●		0	0.5	$\mu\text{A}$
	$V_{SHDN1}, V_{SHDN2} = 20\text{V}$	●		1	3	$\mu\text{A}$
Quiescent Current in Shutdown	$V_{IN} = 6\text{V}$ , $V_{SHDN1} = 0\text{V}$ , $V_{SHDN2} = 0\text{V}$			0.01	0.1	$\mu\text{A}$
Ripple Rejection	$V_{IN} = 2.72\text{V}$ (Avg), $V_{RIPPLE} = 0.5\text{V}_{P-P}$ , $f_{RIPPLE} = 120\text{Hz}$ , $I_{LOAD} = \text{Full Current}$		55	65		dB

## ELECTRICAL CHARACTERISTICS

The ● denotes the specifications which apply over the full operating temperature range, otherwise specifications are at  $T_A = 25^\circ\text{C}$ . (Note 2)

PARAMETER	CONDITIONS	MIN	TYP	MAX	UNITS
Current Limit	Output 2, $V_{IN} = 7V$ , $V_{OUT} = 0V$ $V_{IN} = 2.3V$ , $\Delta V_{OUT} = -0.1V$	● 110	200		mA mA
	Output 1, $V_{IN} = 7V$ , $V_{OUT} = 0V$ $V_{IN} = 2.3V$ , $\Delta V_{OUT} = -0.1V$	● 520	700		mA mA
Input Reverse Leakage Current	$V_{IN} = -20V$ , $V_{OUT} = 0V$	●		1	mA
Reverse Output Current (Notes 3,10)	$V_{OUT} = 1.22V$ , $V_{IN} < 1.22V$		5	10	$\mu\text{A}$

**Note 1:** Stresses beyond those listed under Absolute Maximum Ratings may cause permanent damage to the device. Exposure to any Absolute Maximum Rating condition for extended periods may affect device reliability and lifetime.

**Note 2:** The LT3024 is tested and specified under pulse load conditions such that  $T_J \cong T_A$ . The LT3024E is 100% tested at  $T_A = 25^\circ\text{C}$ . Performance at  $-40^\circ\text{C}$  and  $125^\circ\text{C}$  is assured by design, characterization and correlation with statistical process controls. The LT3024I is guaranteed over the full  $-40^\circ\text{C}$  to  $125^\circ\text{C}$  operating junction temperature range.

**Note 3:** The LT3024 is tested and specified for these conditions with the ADJ1/ADJ2 pin connected to the corresponding OUT1/OUT2 pin.

**Note 4:** Operating conditions are limited by maximum junction temperature. The regulated output voltage specification will not apply for all possible combinations of input voltage and output current. When operating at maximum input voltage, the output current range must be limited. When operating at maximum output current, the input voltage range must be limited.

**Note 5:** To satisfy requirements for minimum input voltage, the LT3024 is tested and specified for these conditions with an external resistor divider (two 250k resistors) for an output voltage of 2.44V. The external resistor divider will add a 5 $\mu\text{A}$  DC load on the output.

**Note 6:** Dropout voltage is the minimum input to output voltage differential needed to maintain regulation at a specified output current. In dropout, the output voltage will be equal to:  $V_{IN} - V_{DROPOUT}$ .

**Note 7:** GND pin current is tested with  $V_{IN} = 2.44V$  and a current source load. This means the device is tested while operating in its dropout region or at the minimum input voltage specification. This is the worst-case GND pin current. The GND pin current will decrease slightly at higher input voltages. Total GND pin current is equal to the sum of GND pin currents from Output 1 and Output 2.

**Note 8:** ADJ1 and ADJ2 pin bias current flows into the pin.

**Note 9:**  $\overline{\text{SHDN1}}$  and  $\overline{\text{SHDN2}}$  pin current flows into the pin.

**Note 10:** Reverse output current is tested with the IN pin grounded and the OUT pin forced to the rated output voltage. This current flows into the OUT pin and out the GND pin.

**Note 11:** For the LT3024 dropout voltage will be limited by the minimum input voltage specification under some output voltage/load conditions. See the curve of Minimum Input Voltage in the Typical Performance Characteristics.

# TYPICAL PERFORMANCE CHARACTERISTICS

**Output 2  
Typical Dropout Voltage**

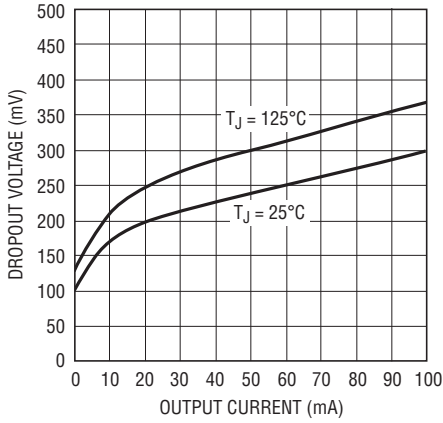

3024 G01

**Output 2  
Guaranteed Dropout Voltage**

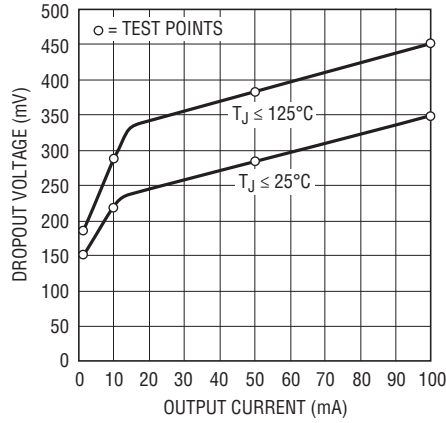

3024 G02

**Output 2 Dropout Voltage**

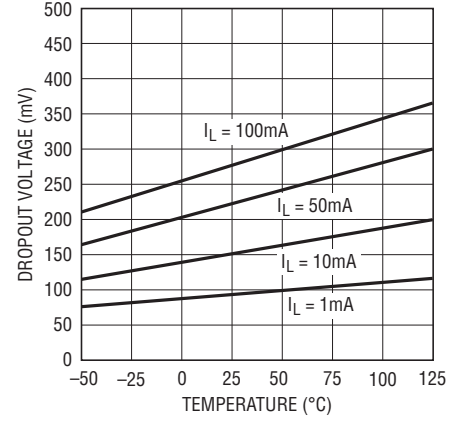

3024 G03

**Output 1  
Typical Dropout Voltage**

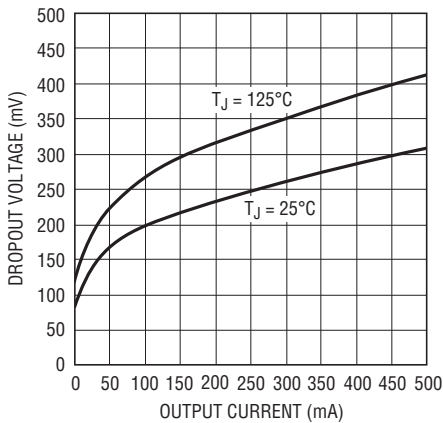

3024 G04

**Output 1  
Guaranteed Dropout Voltage**

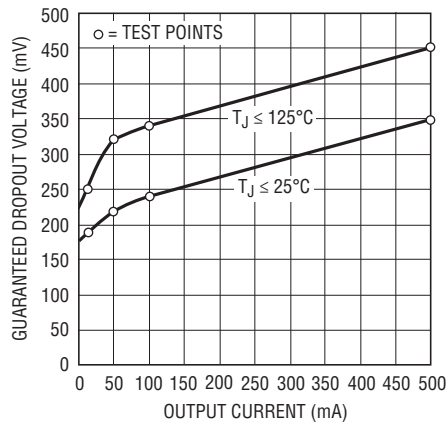

3024 G05

**Output 1 Dropout Voltage**

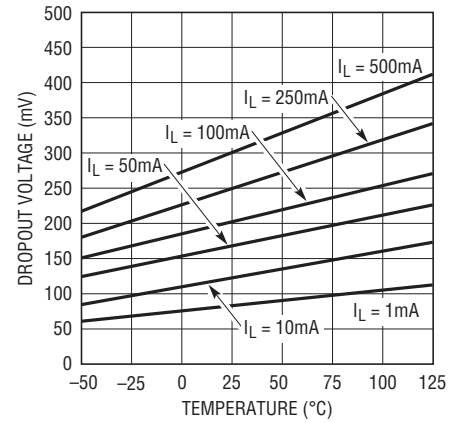

3024 G06

**Quiescent Current (Per Output)**

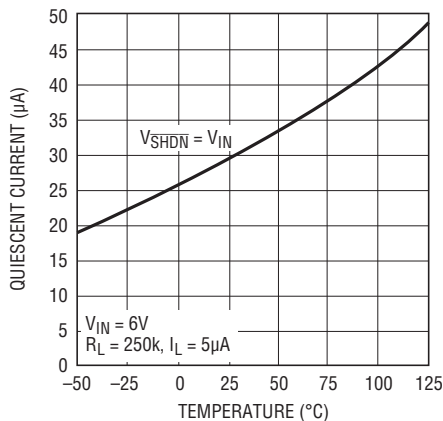

3024 G07

**ADJ1 or ADJ2 Pin Voltage**

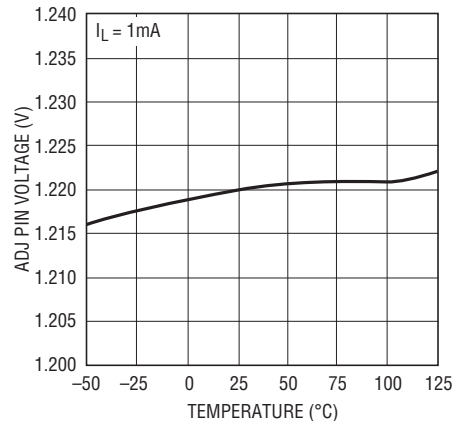

3024 G08

TYPICAL PERFORMANCE CHARACTERISTICS

Quiescent Current (Per Output)

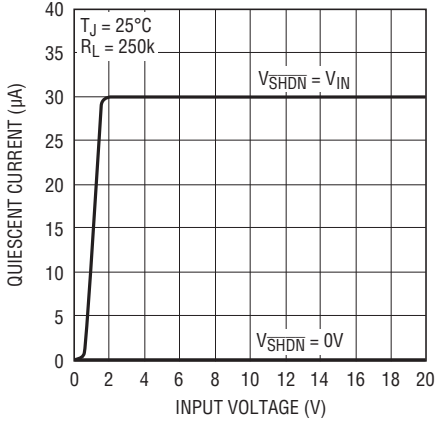

Output 2 GND Pin Current

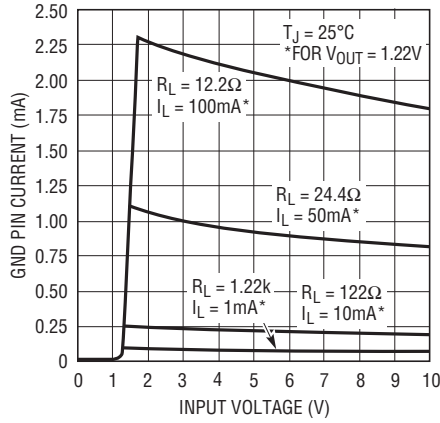

Output 2 GND Pin Current vs  $I_{LOAD}$

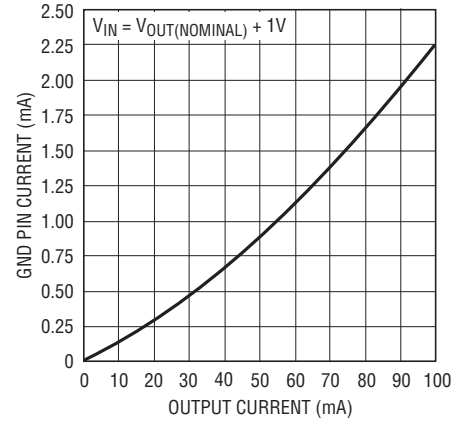

Output 1 GND Pin Current

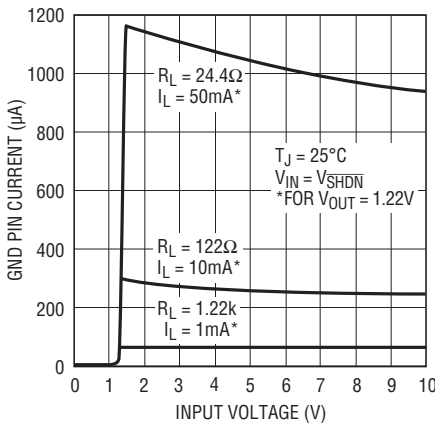

Output 1 GND Pin Current

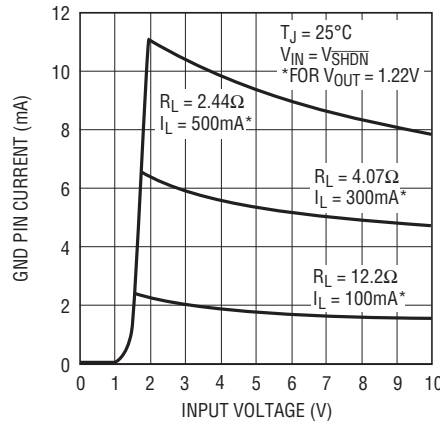

Output 1 GND Pin Current vs  $I_{LOAD}$

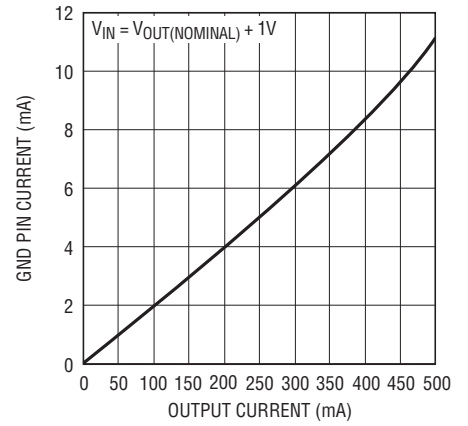

SHDN1 or SHDN2 Pin Threshold (On-to-Off)

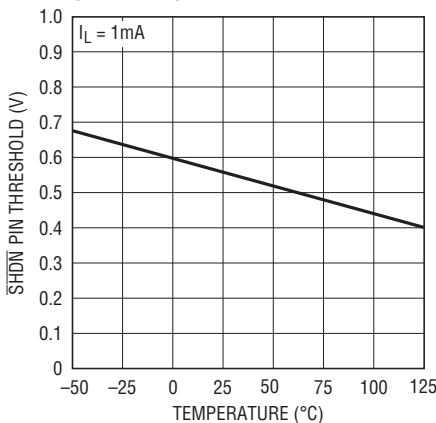

SHDN1 or SHDN2 Pin Threshold (Off-to-On)

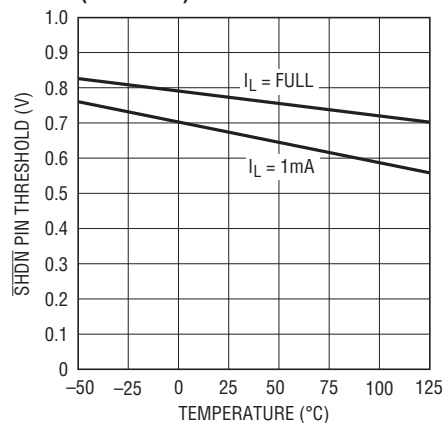

# TYPICAL PERFORMANCE CHARACTERISTICS

**SHDN1 or SHDN2 Pin Input Current**

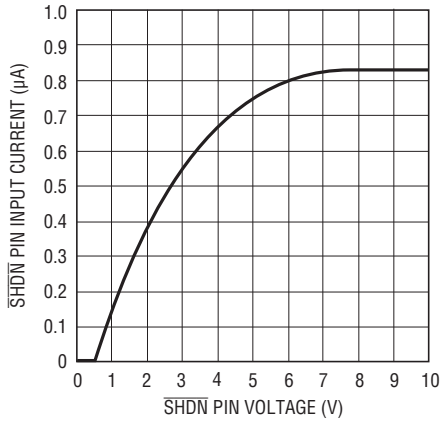

3024 G17

**SHDN1 or SHDN2 Pin Input Current**

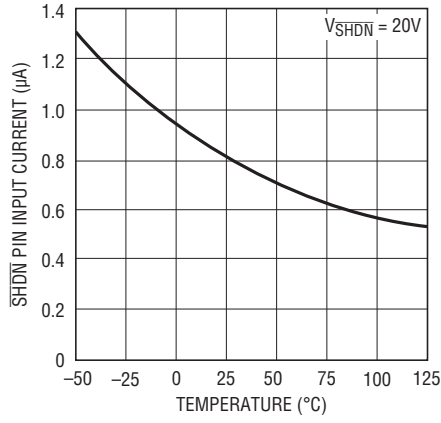

3024 G18

**ADJ1 or ADJ2 Pin Bias Current**

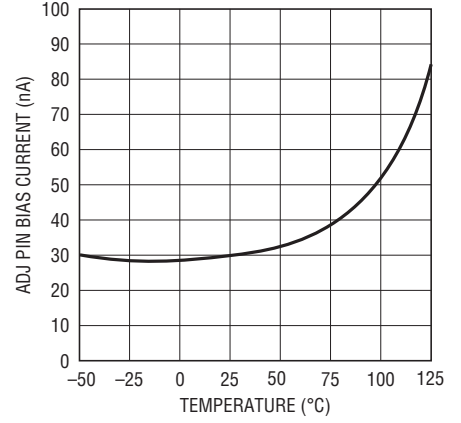

3024 G19

**Output 2 Current Limit**

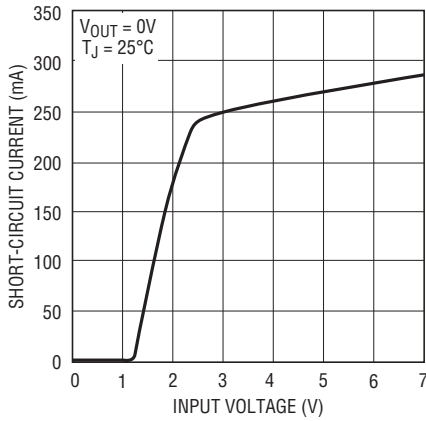

3024 G20

**Output 2 Current Limit**

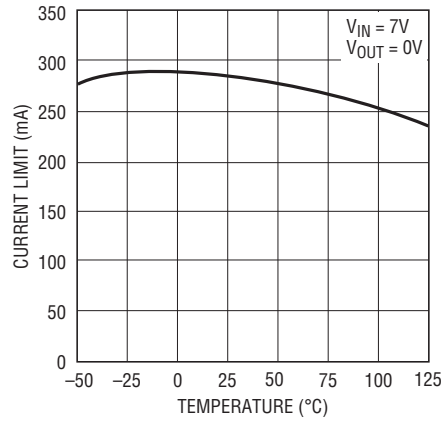

3024 G21

**Output 1 Current Limit**

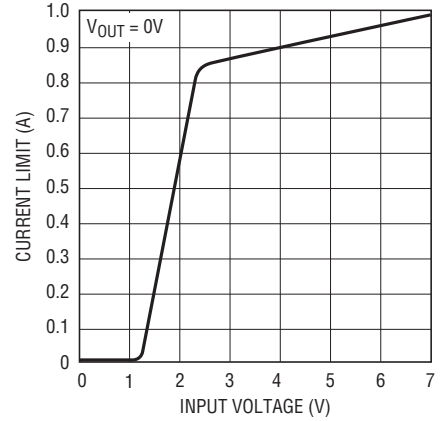

3024 G22

**Output 1 Current Limit**

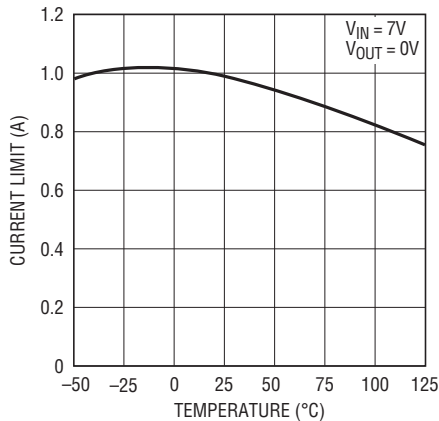

3024 G23

**Reverse Output Current**

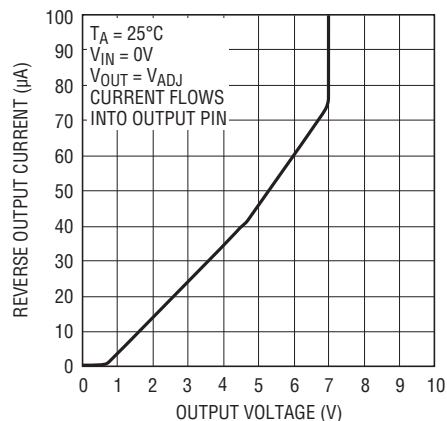

3024 G24

TYPICAL PERFORMANCE CHARACTERISTICS

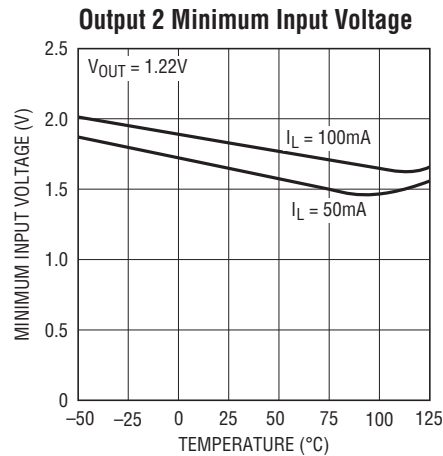
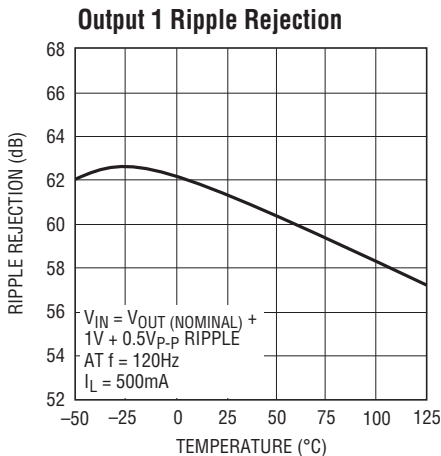
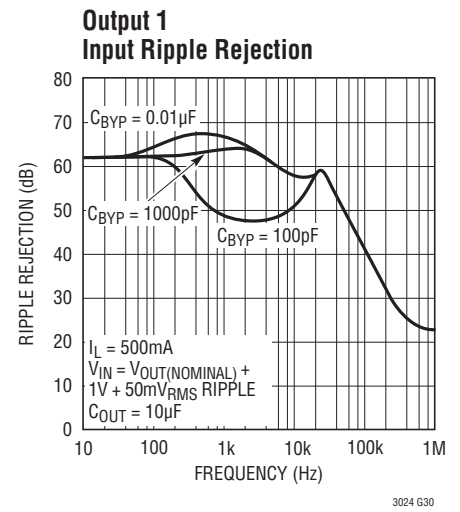
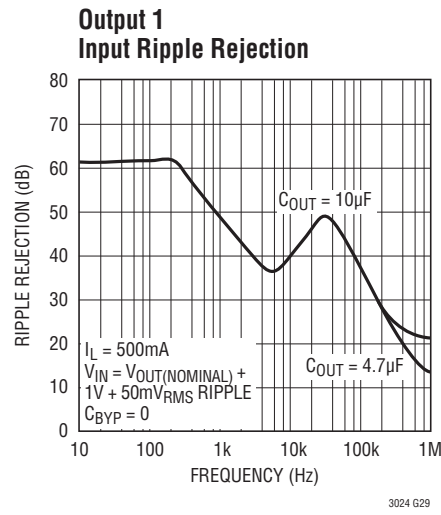
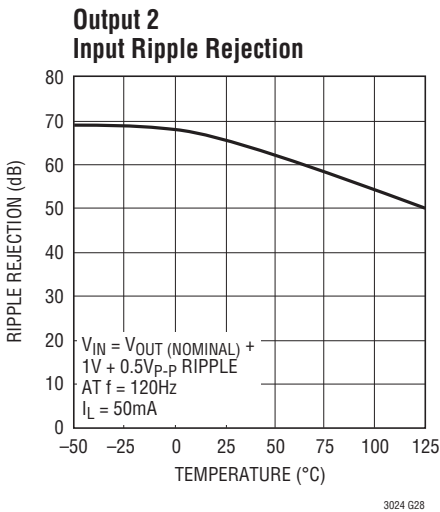
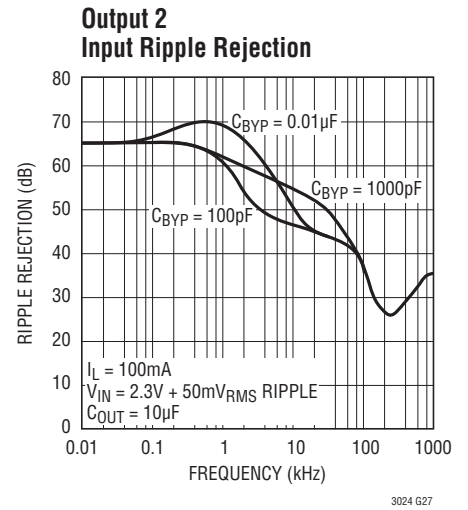
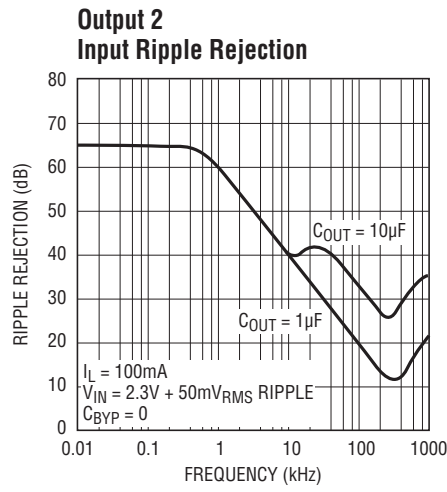
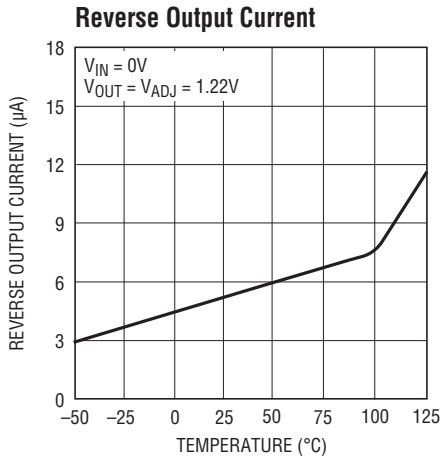

# TYPICAL PERFORMANCE CHARACTERISTICS

**Output 1 Minimum Input Voltage**

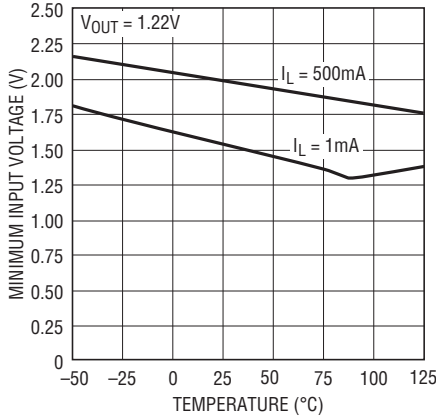

3024 G33

**Channel-to-Channel Isolation**

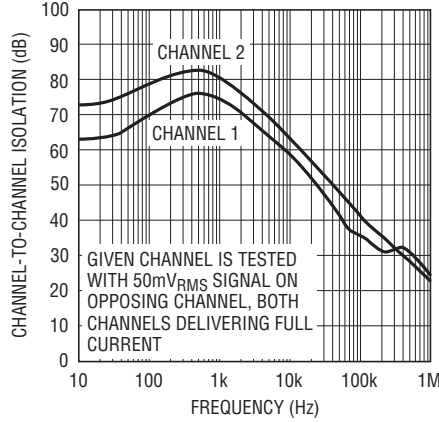

3024 G34

**Channel-to-Channel Isolation**

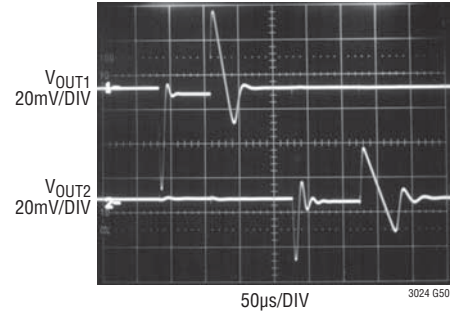

3024 G50  
 $C_{OUT1} = 22\mu F$   
 $C_{OUT2} = 10\mu F$   
 $C_{BYP1} = C_{BYP2} = 0.01\mu F$   
 $\Delta I_{L1} = 50mA TO 500mA$   
 $\Delta I_{L2} = 10mA TO 100mA$   
 $V_{IN} = 6V, V_{OUT1} = V_{OUT2} = 5V$

**Output 2 Load Regulation**

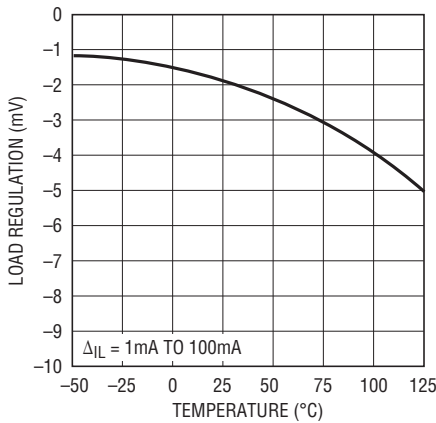

3024 G35

**Output 1 Load Regulation**

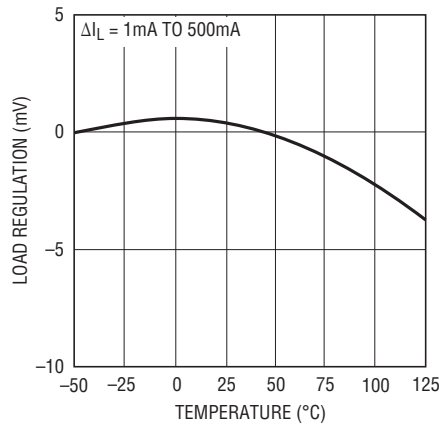

3024 G36

**Output Noise Spectral Density**

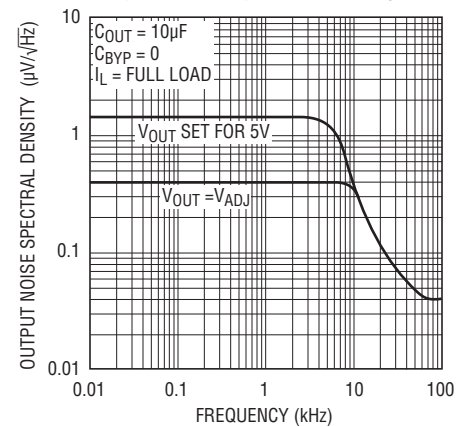

3024 G37

**Output Noise Spectral Density**

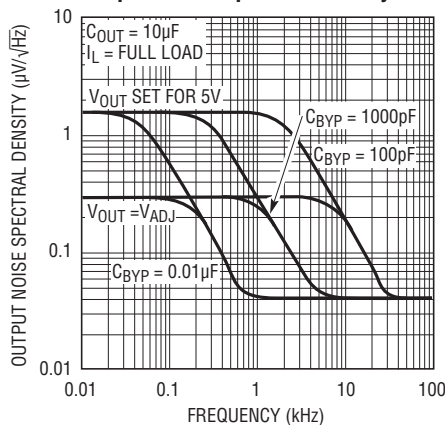

3023 G38

**RMS Output Noise vs Bypass Capacitor**

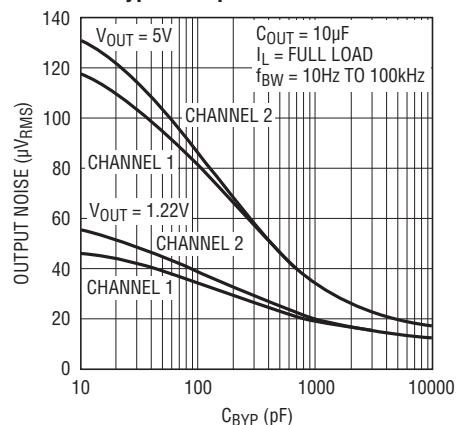

3024 G39

# TYPICAL PERFORMANCE CHARACTERISTICS

**Output 2  
RMS Output Noise vs Load  
Current (10Hz to 100kHz)**

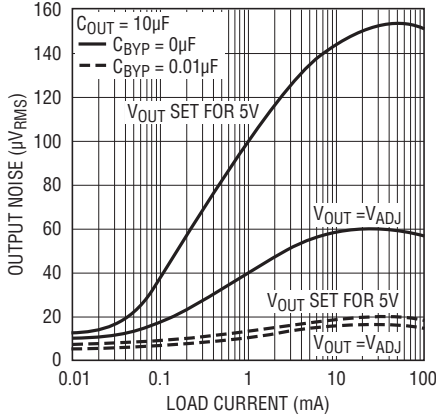

3024 G40

**Output 1  
RMS Output Noise vs Load  
Current (10Hz to 100kHz)**

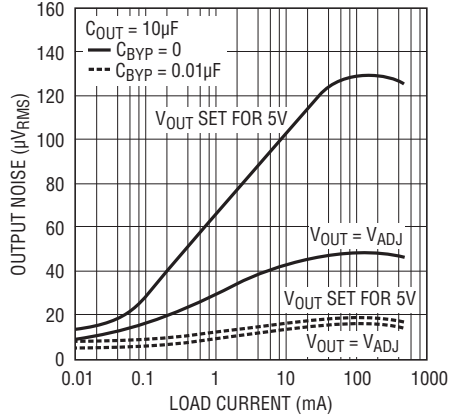

3024 G41

**10Hz to 100kHz Output Noise  
C<sub>BYP</sub> = 0pF**

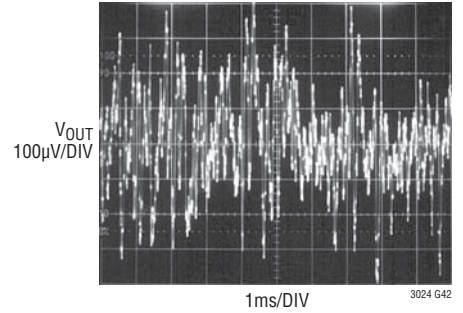

C<sub>OUT</sub> = 10µF  
I<sub>L</sub> = 100mA  
V<sub>OUT</sub> SET FOR 5V

3024 G42

**10Hz to 100kHz Output Noise  
C<sub>BYP</sub> = 100pF**

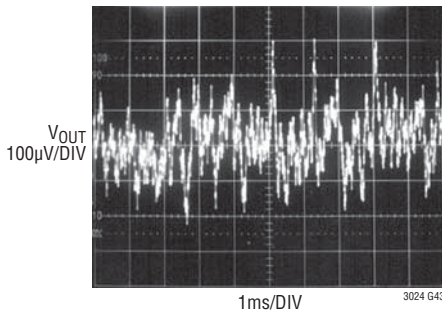

C<sub>OUT</sub> = 10µF  
I<sub>L</sub> = 100mA  
V<sub>OUT</sub> SET FOR 5V

3024 G43

**10Hz to 100kHz Output Noise  
C<sub>BYP</sub> = 1000pF**

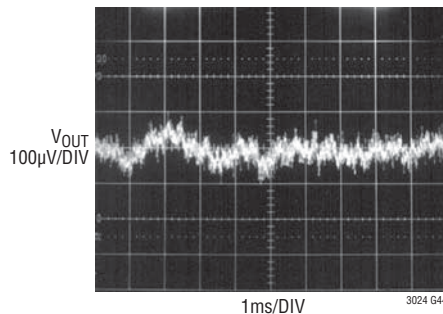

C<sub>OUT</sub> = 10µF  
I<sub>L</sub> = 100mA  
V<sub>OUT</sub> SET FOR 5V

3024 G44

**10Hz to 100kHz Output Noise  
C<sub>BYP</sub> = 0.01µF**

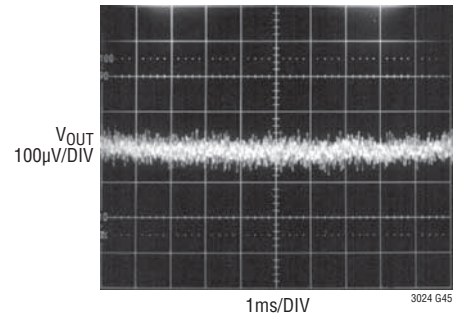

C<sub>OUT</sub> = 10µF  
I<sub>L</sub> = 100mA  
V<sub>OUT</sub> SET FOR 5V

3024 G45

# TYPICAL PERFORMANCE CHARACTERISTICS

**Output 2 Transient Response**  
**C<sub>BYP</sub> = 0pF**

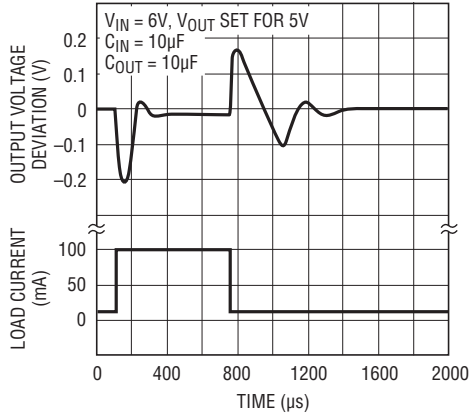

3024 G46

**Output 2 Transient Response**  
**C<sub>BYP</sub> = 0.01μF**

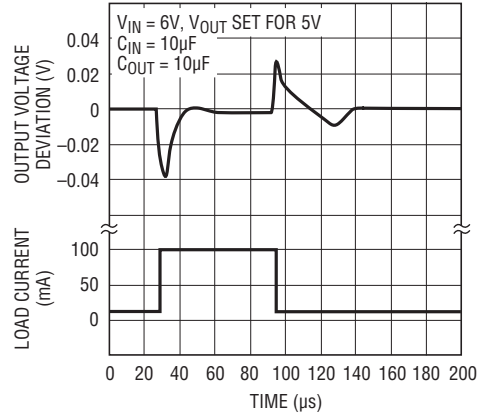

3024 G47

**Output 1 Transient Response**  
**C<sub>BYP</sub> = 0pF**

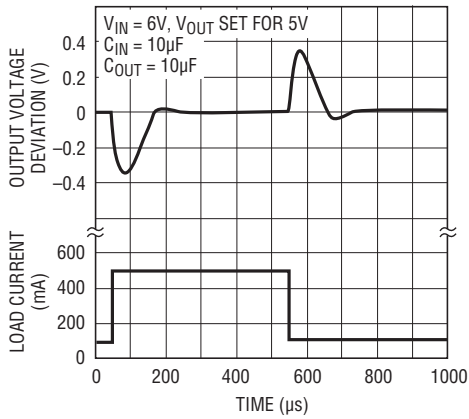

3024 G48

**Output 1 Transient Response**  
**C<sub>BYP</sub> = 0.01μF**

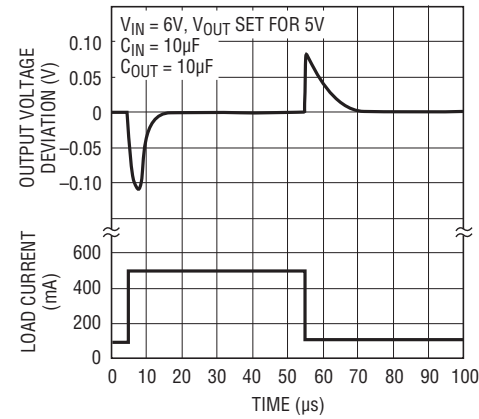

3024 G49

## PIN FUNCTIONS (DFN/TSSOP)

**GND (Pins 4, 13)/(Pins 1, 5, 8, 9, 16, 17):** Ground. The Exposed Pad must be soldered to PCB ground for optimum thermal performance.

**ADJ1/ADJ2 (Pins 12/7)/(Pins 15/10):** Adjust Pin. These are the input to the error amplifiers. These pins are internally clamped to  $\pm 7V$ . They have a bias current of 30nA which flows into the pin (see curve of ADJ1/ADJ2 Pin Bias Current vs Temperature in the Typical Performance Characteristics section). The ADJ1 and ADJ2 pin voltage is 1.22V referenced to ground and the output voltage range is 1.22V to 20V.

**BYP1/BYP2 (Pins 1/6)/(Pins 2/7):** Bypass. The BYP1/BYP2 pins are used to bypass the reference of the LT3024 regulator to achieve low noise performance from the regulator. The BYP1/BYP2 pins are clamped internally to  $\pm 0.6V$  (one  $V_{BE}$ ) from ground. A small capacitor from the corresponding output to this pin will bypass the reference to lower the output voltage noise. A maximum value of 0.01 $\mu F$  can be used for reducing output voltage noise to a typical 20 $\mu V_{RMS}$  over a 10Hz to 100kHz bandwidth. If not used, this pin must be left unconnected.

**OUT1/OUT2 (Pins 2, 3/5)/(Pins 3, 4/6):** Output. The outputs supply power to the loads. A minimum output capacitor of 1 $\mu F$  is required to prevent oscillations on Output 2; Output 1 requires a minimum of 3.3 $\mu F$ . Larger output capacitors will be required for applications with large transient loads to limit peak voltage transients. See the Applications Information section for more information on output capacitance and reverse output characteristics.

**SHDN1/SHDN2 (Pins 11/8)/(Pins 14/11):** Shutdown. The SHDN1/SHDN2 pins are used to put the corresponding output of the LT3024 regulator into a low power shutdown state. The output will be off when the pin is pulled low. The SHDN1/SHDN2 pins can be driven either by 5V logic or open-collector logic with pull-up resistors. The pull-up resistors are required to supply the pull-up current of the open-collector gates, normally several microamperes, and the SHDN1/SHDN2 pin current, typically 1 $\mu A$ . If unused, the pin must be connected to  $V_{IN}$ . The device will not function if the SHDN1/SHDN2 pins are not connected.

**IN (Pins 9, 10)/(Pins 12, 13):** Input. Power is supplied to the device through the IN pin. A bypass capacitor is required on this pin if the device is more than six inches away from the main input filter capacitor. In general, the output impedance of a battery rises with frequency, so it is advisable to include a bypass capacitor in battery-powered circuits. A bypass capacitor in the range of 1 $\mu F$  to 10 $\mu F$  is sufficient. The LT3024 regulator is designed to withstand reverse voltages on the IN pin with respect to ground and the OUT pin. In the case of a reverse input, which can happen if a battery is plugged in backwards, the device will act as if there is a diode in series with its input. There will be no reverse current flow into the regulator and no reverse voltage will appear at the load. The device will protect both itself and the load.

## APPLICATIONS INFORMATION

The LT3024 is a dual 100mA/500mA low dropout regulator with micropower quiescent current and shutdown. The device is capable of supplying 100mA from Output 2 at a dropout voltage of 300mV. Output 1 delivers 500mA at a dropout voltage of 300mV. The two regulators have common  $V_{IN}$  and GND pins and are thermally coupled, however, the two outputs of the LT3024 operate independently. They can be shut down independently and a fault condition on one output will not affect the other output electrically. Output voltage noise can be lowered to  $20\mu V_{RMS}$  over a 10Hz to 100kHz bandwidth with the addition of a  $0.01\mu F$  reference bypass capacitor. Additionally, the reference bypass capacitor will improve transient response of the regulator, lowering the settling time for transient load conditions. The low operating quiescent current ( $30\mu A$  per output) drops to less than  $1\mu A$  in shutdown. In addition to the low quiescent current, the LT3024 regulator incorporates several protection features which make it ideal for use in battery-powered systems. The device is protected against both reverse input and reverse output voltages. In battery backup applications where the output can be held up by a backup battery when the input is pulled to ground, the LT3024 acts like it has a diode in series with its output and prevents reverse current flow. Additionally, in dual supply applications where the regulator load is returned to a negative supply, the output can be pulled below ground by as much as 20V and still allow the device to start and operate.

### Adjustable Operation

The LT3024 has an output voltage range of 1.22V to 20V. The output voltage is set by the ratio of two external resistors as shown in Figure 1. The device servos the output to maintain the corresponding ADJ pin voltage at 1.22V referenced to ground. The current in R1 is then equal to  $1.22V/R1$  and the current in R2 is the current in R1 plus the ADJ pin bias current. The ADJ pin bias current, 30nA at 25°C, flows through R2 into the ADJ pin. The output voltage can be calculated using the formula in Figure 1. The

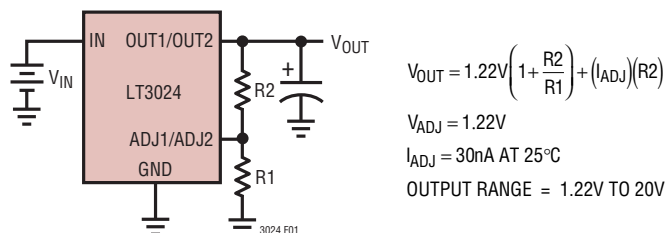

Figure 1. Adjustable Operation

value of R1 should be no greater than 250k to minimize errors in the output voltage caused by the ADJ pin bias current. Note that in shutdown the output is turned off and the divider current will be zero. Curves of ADJ Pin Voltage vs Temperature and ADJ Pin Bias Current vs Temperature appear in the Typical Performance Characteristics.

The device is tested and specified with the ADJ pin tied to the corresponding OUT pin for an output voltage of 1.22V. Specifications for output voltages greater than 1.22V will be proportional to the ratio of the desired output voltage to 1.22V:  $V_{OUT}/1.22V$ . For example, load regulation on Output 2 for an output current change of 1mA to 100mA is  $-1mV$  typical at  $V_{OUT} = 1.22V$ . At  $V_{OUT} = 12V$ , load regulation is:

$$(12V/1.22V)(-1mV) = -9.8mV$$

### Bypass Capacitance and Low Noise Performance

The LT3024 regulator may be used with the addition of a bypass capacitor from  $V_{OUT}$  to the corresponding BYP pin to lower output voltage noise. A good quality low leakage capacitor is recommended. This capacitor will bypass the reference of the regulator, providing a low frequency noise pole. The noise pole provided by this bypass capacitor will lower the output voltage noise to as low as  $20\mu V_{RMS}$  with the addition of a  $0.01\mu F$  bypass capacitor. Using a bypass capacitor has the added benefit of improving transient response. With no bypass capacitor and a  $10\mu F$  output capacitor, a 10mA to 100mA load step on Output 2 will settle to within 1% of its final value in less than 100 $\mu s$ . With the addition of a  $0.01\mu F$  bypass capacitor, the output will stay

## APPLICATIONS INFORMATION

within 1% for the same load step. Both outputs exhibit this improvement in transient response (see Transient Reponse in Typical Performance Characteristics section). However, regulator start-up time is proportional to the size of the bypass capacitor, slowing to 15ms with a 0.01 $\mu$ F bypass capacitor and 10 $\mu$ F output capacitor.

### Output Capacitance and Transient Response

The LT3024 regulator is designed to be stable with a wide range of output capacitors. The ESR of the output capacitor affects stability, most notably with small capacitors. A minimum output capacitor of 1 $\mu$ F with an ESR of 3 $\Omega$  or less is recommended for Output 2 to prevent oscillations. A minimum output capacitor of 3.3 $\mu$ F with an ESR of 3 $\Omega$  or less is recommended for Output 1. The LT3024 is a micropower device and output transient response will be a function of output capacitance. Larger values of output capacitance decrease the peak deviations and provide improved transient response for larger load current changes. Bypass capacitors, used to decouple individual components powered by the LT3024, will increase the effective output capacitor value. With larger capacitors used to bypass the reference (for low noise operation), larger values of output capacitors are needed. For 100pF of bypass capacitance on Output 2, 2.2 $\mu$ F of output capacitor is recommended. With a 330pF bypass capacitor or larger on this output, a 3.3 $\mu$ F output capacitor is recommended. For Output 1, 4.7 $\mu$ F of output capacitor is recommended for 100pF of bypass capacitance. With 1000pF or larger bypass capacitor on this output, a 6.8 $\mu$ F output capacitor is recommended. The

shaded region of Figures 2 and 3 define the regions over which the LT3024 regulator is stable. The minimum ESR needed is defined by the amount of bypass capacitance used, while the maximum ESR is 3 $\Omega$ .

Extra consideration must be given to the use of ceramic capacitors. Ceramic capacitors are manufactured with a variety of dielectrics, each with different behavior across temperature and applied voltage. The most common dielectrics used are specified with EIA temperature characteristic codes of Z5U, Y5V, X5R and X7R. The Z5U and Y5V dielectrics are good for providing high capacitances in a small package, but they tend to have strong voltage and temperature coefficients as shown in Figures 4 and 5. When used with a 5V regulator, a 16V 10 $\mu$ F Y5V capacitor can exhibit an effective value as low as 1 $\mu$ F to 2 $\mu$ F for the DC bias voltage applied and over the operating temperature range. The X5R and X7R dielectrics result in more stable characteristics and are more suitable for use as the output capacitor. The X7R type has better stability across temperature, while the X5R is less expensive and is available in higher values. Care still must be exercised when using X5R and X7R capacitors; the X5R and X7R codes only specify operating temperature range and maximum capacitance change over temperature. Capacitance change due to DC bias with X5R and X7R capacitors is better than Y5V and Z5U capacitors, but can still be significant enough to drop capacitor values below appropriate levels. Capacitor DC bias characteristics tend to improve as component case size increases, but expected capacitance at operating voltage should be verified.

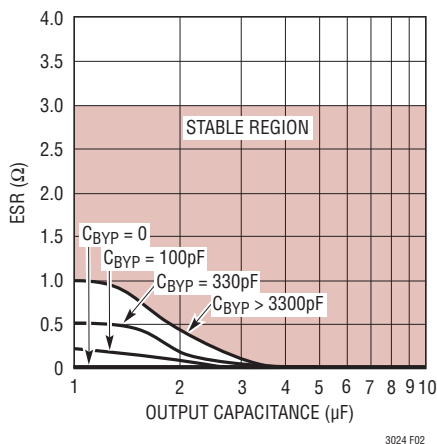

Figure 2. Output 2 Stability

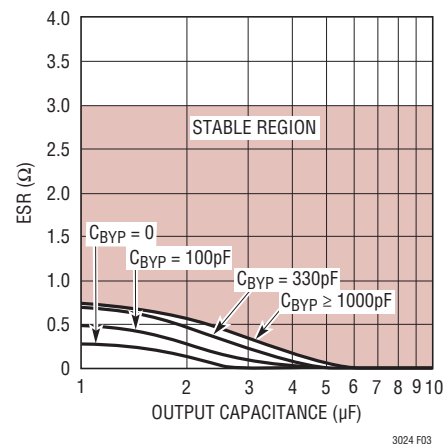

Figure 3. Output 1 Stability

3024fa

## APPLICATIONS INFORMATION

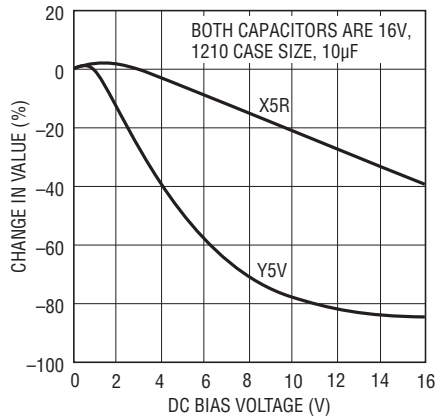

Figure 4. Ceramic Capacitor DC Bias Characteristics

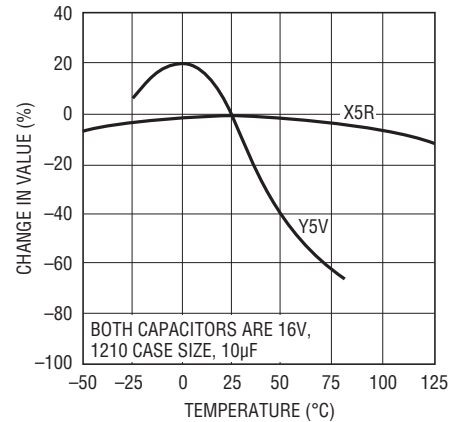

Figure 5. Ceramic Capacitor Temperature Characteristics

Voltage and temperature coefficients are not the only sources of problems. Some ceramic capacitors have a piezoelectric response. A piezoelectric device generates voltage across its terminals due to mechanical stress, similar to the way a piezoelectric accelerometer or microphone works. For a ceramic capacitor the stress can be induced by vibrations in the system or thermal transients. The resulting voltages produced can cause appreciable amounts of noise, especially when a ceramic capacitor is used for noise bypassing. A ceramic capacitor produced Figure 6's trace in response to light tapping from a pencil. Similar vibration induced behavior can masquerade as increased output voltage noise.

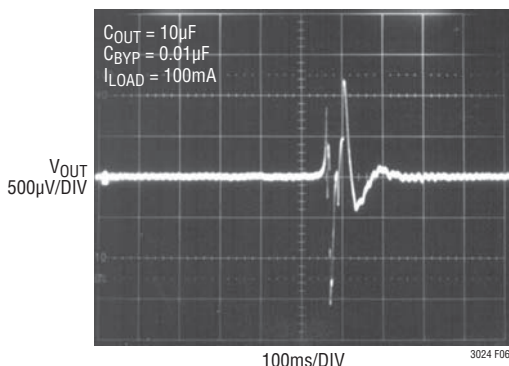

Figure 6. Noise Resulting from Tapping on a Ceramic Capacitor

### Thermal Considerations

The power handling capability of the device will be limited by the maximum rated junction temperature (125°C). The power dissipated by the device will be made up of two components for each output:

1. Output current multiplied by the input/output voltage differential:  $(I_{OUT})(V_{IN} - V_{OUT})$ , and
2. GND pin current multiplied by the input voltage:  $(I_{GND})(V_{IN})$ .

The ground pin current can be found by examining the GND Pin Current curves in the Typical Performance Characteristics section. Power dissipation will be equal to the sum of the two components listed above.

The LT3024 regulator has internal thermal limiting designed to protect the device during overload conditions. For continuous normal conditions, the maximum junction temperature rating of 125°C must not be exceeded. It is important to give careful consideration to all sources of thermal resistance from junction to ambient. Additional heat sources mounted nearby must also be considered.

For surface mount devices, heat sinking is accomplished by using the heat spreading capabilities of the PC board

## APPLICATIONS INFORMATION

and its copper traces. Copper board stiffeners and plated through-holes can also be used to spread the heat generated by power devices.

The following tables list thermal resistance for several different board sizes and copper areas. All measurements were taken in still air on 3/32" FR-4 board with one ounce copper.

**Table 1. FE Package, 16-Lead TSSOP**

COPPER AREA		BOARD AREA	THERMAL RESISTANCE (JUNCTION-TO-AMBIENT)
TOPSIDE*	BACKSIDE		
2500mm <sup>2</sup>	2500mm <sup>2</sup>	2500mm <sup>2</sup>	38°C/W
1000mm <sup>2</sup>	2500mm <sup>2</sup>	2500mm <sup>2</sup>	43°C/W
225mm <sup>2</sup>	2500mm <sup>2</sup>	2500mm <sup>2</sup>	48°C/W
100mm <sup>2</sup>	2500mm <sup>2</sup>	2500mm <sup>2</sup>	60°C/W

\*Device is mounted on top side.

**Table 2. UE Package, 12-Lead DFN**

COPPER AREA		BOARD AREA	THERMAL RESISTANCE (JUNCTION-TO-AMBIENT)
TOPSIDE*	BACKSIDE		
2500mm <sup>2</sup>	2500mm <sup>2</sup>	2500mm <sup>2</sup>	40°C/W
1000mm <sup>2</sup>	2500mm <sup>2</sup>	2500mm <sup>2</sup>	45°C/W
225mm <sup>2</sup>	2500mm <sup>2</sup>	2500mm <sup>2</sup>	50°C/W
100mm <sup>2</sup>	2500mm <sup>2</sup>	2500mm <sup>2</sup>	62°C/W

\*Device is mounted on top side.

The thermal resistance junction-to-case ( $\theta_{JC}$ ), measured at the Exposed Pad on the back of the die is 10°C/W for the DFN package and 8°C/W for the TSSOP package.

### Calculating Junction Temperature

Example: Given Output 1 set for an output voltage of 3.3V, Output 2 set for an output voltage of 2.5V, an input voltage range of 3.8V to 5V, an output current range of 0mA to 500mA for Output 1, an output current range of 0mA to 100mA for Output 2 and a maximum ambient temperature of 50°C, what will the maximum junction temperature be?

The power dissipated by each output will be equal to:

$$I_{OUT(MAX)}(V_{IN(MAX)} - V_{OUT}) + I_{GND}(V_{IN(MAX)})$$

Where for Output 1:

$$I_{OUT(MAX)} = 500\text{mA}$$

$$V_{IN(MAX)} = 5\text{V}$$

$$I_{GND} \text{ at } (I_{OUT} = 500\text{mA}, V_{IN} = 5\text{V}) = 9\text{mA}$$

For Output 2:

$$I_{OUT(MAX)} = 100\text{mA}$$

$$V_{IN(MAX)} = 5\text{V}$$

$$I_{GND} \text{ at } (I_{OUT} = 100\text{mA}, V_{IN} = 5\text{V}) = 2\text{mA}$$

So for Output 1:

$$P = 500\text{mA} (5\text{V} - 3.3\text{V}) + 9\text{mA} (5\text{V}) = 0.90\text{W}$$

For Output 2:

$$P = 100\text{mA} (5\text{V} - 2.5\text{V}) + 2\text{mA} (5\text{V}) = 0.26\text{W}$$

The thermal resistance will be in the range of 35°C/W to 55°C/W depending on the copper area. So the junction temperature rise above ambient will be approximately equal to:

$$(0.90\text{W} + 0.26\text{W}) 50^\circ\text{C/W} = 57.8^\circ\text{C}$$

The maximum junction temperature will then be equal to the maximum junction temperature rise above ambient plus the maximum ambient temperature or:

$$T_{JMAX} = 50^\circ\text{C} + 57.8^\circ\text{C} = 107.8^\circ\text{C}$$

### Protection Features

The LT3024 regulator incorporates several protection features which make it ideal for use in battery-powered circuits. In addition to the normal protection features associated with monolithic regulators, such as current limiting and thermal limiting, the device is protected against reverse input voltages, reverse output voltages and reverse voltages from output to input. The two regulators have common

## APPLICATIONS INFORMATION

$V_{IN}$  and GND pins and are thermally coupled, however, the two outputs of the LT3024 operate independently. They can be shut down independently and a fault condition on one output will not affect the other output electrically.

Current limit protection and thermal overload protection are intended to protect the device against current overload conditions at the output of the device. For normal operation, the junction temperature should not exceed 125°C.

The input of the device will withstand reverse voltages of 20V. Current flow into the device will be limited to less than 1mA (typically less than 100 $\mu$ A) and no negative voltage will appear at the output. The device will protect both itself and the load. This provides protection against batteries which can be plugged in backward.

The output of the LT3024 can be pulled below ground without damaging the device. If the input is left open circuit or grounded, the output can be pulled below ground by 20V. The output will act like an open circuit; no current will flow out of the pin. If the input is powered by a voltage source, the output will source the short-circuit current of the device and will protect itself by thermal limiting. In this case, grounding the SHDN1/SHDN2 pins will turn off the device and stop the output from sourcing the short-circuit current.

The ADJ pins can be pulled above or below ground by as much as 7V without damaging the device. If the input is left open circuit or grounded, the ADJ pins will act like an open circuit when pulled below ground and like a large resistor (typically 100k) in series with a diode when pulled above ground.

In situations where the ADJ pins are connected to a resistor divider that would pull the pins above their 7V clamp voltage if the output is pulled high, the ADJ pin input current must be limited to less than 5mA. For example, a resistor divider is used to provide a regulated 1.5V output from the

1.22V reference when the output is forced to 20V. The top resistor of the resistor divider must be chosen to limit the current into the ADJ pin to less than 5mA when the ADJ pin is at 7V. The 13V difference between output and ADJ pin divided by the 5mA maximum current into the ADJ pin yields a minimum top resistor value of 2.6k.

In circuits where a backup battery is required, several different input/output conditions can occur. The output voltage may be held up while the input is either pulled to ground, pulled to some intermediate voltage or is left open circuit. Current flow back into the output will follow the curve shown in Figure 7.

When the IN pin of the LT3024 is forced below either OUT pin or either OUT pin is pulled above the IN pin, input current for the corresponding regulator will typically drop to less than 2 $\mu$ A. This can happen if the input of the device is connected to a discharged (low voltage) battery and the output is held up by either a backup battery or a second regulator circuit. The state of the SHDN1/SHDN2 pin will have no effect on the reverse output current when the output is pulled above the input.

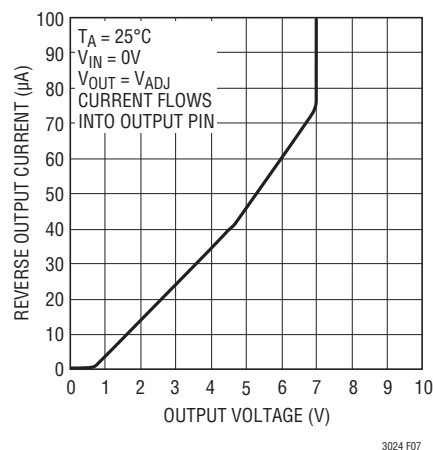
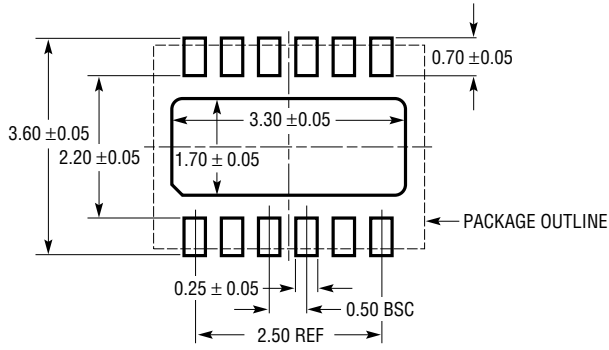

Figure 7. Reverse Output Current

# PACKAGE DESCRIPTION

**DE/UE Package**  
**12-Lead Plastic DFN (4mm × 3mm)**  
 (Reference LTC DWG # 05-08-1695 Rev D)



RECOMMENDED SOLDER PAD PITCH AND DIMENSIONS  
 APPLY SOLDER MASK TO AREAS THAT ARE NOT SOLDERED

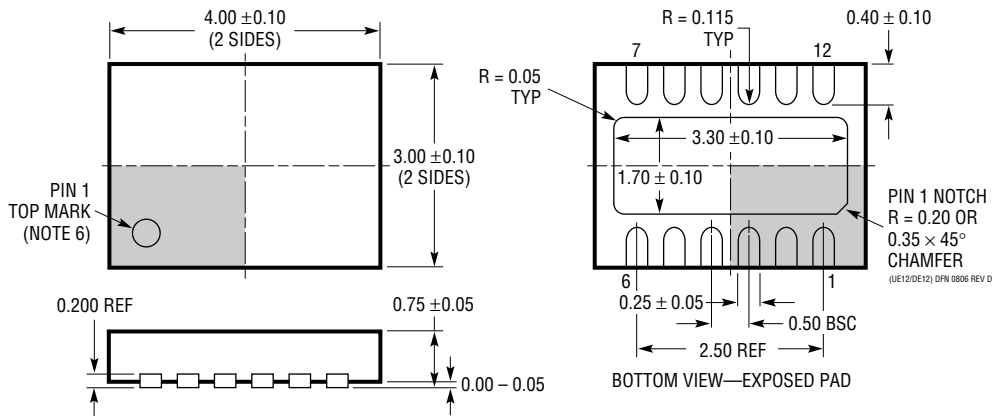

- NOTE:
1. DRAWING PROPOSED TO BE A VARIATION OF VERSION (WGED) IN JEDEC PACKAGE OUTLINE MO-229
  2. DRAWING NOT TO SCALE
  3. ALL DIMENSIONS ARE IN MILLIMETERS
  4. DIMENSIONS OF EXPOSED PAD ON BOTTOM OF PACKAGE DO NOT INCLUDE MOLD FLASH. MOLD FLASH, IF PRESENT, SHALL NOT EXCEED 0.15mm ON ANY SIDE
  5. EXPOSED PAD SHALL BE SOLDER PLATED
  6. SHADED AREA IS ONLY A REFERENCE FOR PIN 1 LOCATION ON THE TOP AND BOTTOM OF PACKAGE

**PACKAGE DESCRIPTION**

**FE Package**  
**16-Lead Plastic TSSOP (4.4mm)**  
 (Reference LTC DWG # 05-08-1663)  
**Exposed Pad Variation BB**

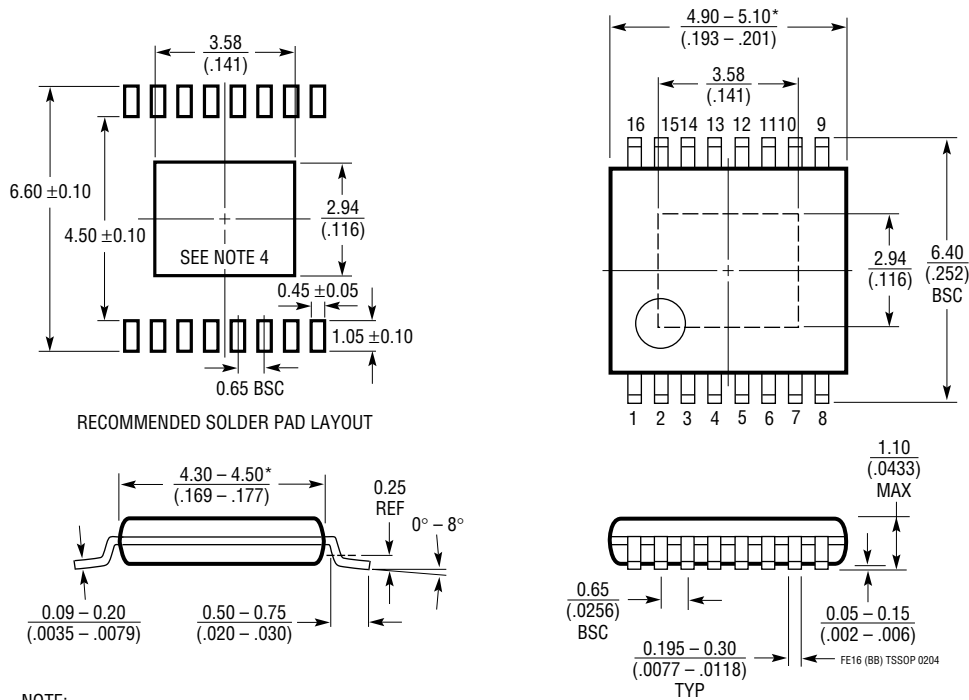

- NOTE:
1. CONTROLLING DIMENSION: MILLIMETERS
  2. DIMENSIONS ARE IN MILLIMETERS (INCHES)
  3. DRAWING NOT TO SCALE
  4. RECOMMENDED MINIMUM PCB METAL SIZE FOR EXPOSED PAD ATTACHMENT
- \*DIMENSIONS DO NOT INCLUDE MOLD FLASH. MOLD FLASH SHALL NOT EXCEED 0.150mm (.006") PER SIDE

## RELATED PARTS

PART NUMBER	DESCRIPTION	COMMENTS
LT1129	700mA, Micropower, LDO	$V_{IN}$ : 4.2V to 30V, $V_{OUT(MIN)}$ = 3.75V, $I_Q$ = 50 $\mu$ A, $I_{SD}$ = 16 $\mu$ A, DD, SOT-223, S8, TO220, TSSOP20 Packages
LT1175	500mA, Micropower Negative LDO	Guaranteed Voltage Tolerance and Line/Load Regulation, $V_{IN}$ : -20V to -4.3V, $V_{OUT(MIN)}$ = -3.8V, $I_Q$ = 45 $\mu$ A, $I_{SD}$ = 10 $\mu$ A, DD, SOT-223, S8 Packages
LT1185	3A, Negative LDO	Accurate Programmable Current Limit, Remote Sense, $V_{IN}$ : -35V to -4.2V, $V_{OUT(MIN)}$ = -2.40V, $I_Q$ = 2.5mA, $I_{SD}$ < 1 $\mu$ A, TO220-5 Package
LT1761	100mA, Low Noise Micropower, LDO	Low Noise < 20 $\mu$ V <sub>RMS</sub> , Stable with 1 $\mu$ F Ceramic Capacitors, $V_{IN}$ : 1.8V to 20V, $V_{OUT(MIN)}$ = 1.22V, $I_Q$ = 20 $\mu$ A, $I_{SD}$ < 1 $\mu$ A, ThinSOT Package
LT1762	150mA, Low Noise Micropower, LDO	Low Noise < 20 $\mu$ V <sub>RMS</sub> , $V_{IN}$ : 1.8V to 20V, $V_{OUT(MIN)}$ = 1.22V, $I_Q$ = 25 $\mu$ A, $I_{SD}$ < 1 $\mu$ A, MS8 Package
LT1763	500mA, Low Noise Micropower, LDO	Low Noise < 20 $\mu$ V <sub>RMS</sub> , $V_{IN}$ : 1.8V to 20V, $V_{OUT(MIN)}$ = 1.22V, $I_Q$ = 30 $\mu$ A, $I_{SD}$ < 1 $\mu$ A, S8 Package
LT1764/LT1764A	3A, Low Noise, Fast Transient Response, LDO	Low Noise < 40 $\mu$ V <sub>RMS</sub> , "A" Version Stable with Ceramic Capacitors, $V_{IN}$ : 2.7V to 20V, $V_{OUT(MIN)}$ = 1.21V, $I_Q$ = 1mA, $I_{SD}$ < 1 $\mu$ A, DD, TO220 Packages
LTC1844	150mA, Very Low Drop-Out LDO	Low Noise < 30 $\mu$ V <sub>RMS</sub> , Stable with 1 $\mu$ F Ceramic Capacitors, $V_{IN}$ : 1.6V to 6.5V, $V_{OUT(MIN)}$ = 1.25V, $I_Q$ = 40 $\mu$ A, $I_{SD}$ < 1 $\mu$ A, ThinSOT Package
LT1962	300mA, Low Noise Micropower, LDO	Low Noise < 20 $\mu$ V <sub>RMS</sub> , $V_{IN}$ : 1.8V to 20V, $V_{OUT(MIN)}$ = 1.22V, $I_Q$ = 30 $\mu$ A, $I_{SD}$ < 1 $\mu$ A, MS8 Package
LT1963/LT1963A	1.5A, Low Noise, Fast Transient Response, LDO	Low Noise < 40 $\mu$ V <sub>RMS</sub> , "A" Version Stable with Ceramic Capacitors, $V_{IN}$ : 2.1V to 20V, $V_{OUT(MIN)}$ = 1.21V, $I_Q$ = 1mA, $I_{SD}$ < 1 $\mu$ A, DD, TO220, SOT-223, S8 Packages
LT1964	200mA, Low Noise Micropower, Negative LDO	Low Noise < 30 $\mu$ V <sub>RMS</sub> , Stable with Ceramic Capacitors, $V_{IN}$ : -0.9V to -20V, $V_{OUT(MIN)}$ = -1.21V, $I_Q$ = 30 $\mu$ A, $I_{SD}$ = 3 $\mu$ A, ThinSOT Package
LT3023	Dual 100mA, Low Noise, Micropower LDO	Low Noise < 20 $\mu$ V <sub>RMS</sub> , Stable with 1 $\mu$ F Ceramic Capacitors, $V_{IN}$ : 1.8V to 20V, $V_{OUT(MIN)}$ = 1.22V, $I_Q$ = 40 $\mu$ A, $I_{SD}$ < 1 $\mu$ A, MS10E, DFN Packages
LTC3407	Dual 600mA, 1.5MHz Synchronous Step Down DC/DC Converter	$V_{IN}$ : 2.5V to 5.5V, $V_{OUT(MIN)}$ = 0.6V, $I_Q$ = 40 $\mu$ A, $I_{SD}$ < 1 $\mu$ A, MSE Package

## Looking for pricing, stock, or lifecycle information?

Click below to explore more details on WIN SOURCE:

 [View LT3024EFE#PBF on WIN SOURCE](#)

 [Linear Technology](#) Information

## Optimize Your Supply Chain with WIN SOURCE Solutions

-  Global Sourcing Solution
-  Obsolete Management
-  Cost Control Management
-  Shortage Management
-  Alternative Solution
-  Excess Inventory Management