



**THE DATASHEET OF
LTC1750CFW#TRPBF**



FEATURES

- **Sample Rate: 80Mps**
- **500MHz Full Power Bandwidth S/H**
- **Direct IF Sampling Up to 500MHz**
- **PGA Front End (2.25V_{P-P} or 1.35V_{P-P} Input Range)**
- **75.5dB SNR and 90dB SFDR (PGA = 0)**
- **73dB SNR and 90dB SFDR (PGA = 1)**
- No Missing Codes
- Single 5V Supply
- Power Dissipation: 1.45W
- Two Pin Selectable Reference Values
- Two's Complement or Offset Binary Outputs
- Out-of-Range Indicator
- Data Ready Output Clock
- Pin-for-Pin Family
- 48-Pin TSSOP Package

APPLICATIONS

- Telecommunications
- Receivers
- Cellular Base Stations
- Spectrum Analysis
- Imaging Systems
- MRI
- Tomography

DESCRIPTION

The LTC[®]1750 is an 80Mps, 14-bit A/D converter designed for digitizing wide dynamic range signals up to frequencies of 500MHz. The input range of the ADC can be optimized with the on-chip PGA sample-and-hold circuit and flexible reference circuitry.

The LTC1750 has a highly linear sample-and-hold circuit with a bandwidth of 500MHz. The SFDR is 82dB with an input frequency of 250MHz. Ultralow jitter of 0.12ps_{RMS} allows undersampling of IF frequencies with minimal degradation in SNR. DC specs include ± 3 LSB INL and no missing codes.

The digital interface is compatible with 5V, 3V, 2V and LVDS logic systems. The \overline{ENC} and ENC inputs may be driven differentially from PECL, GTL and other low swing logic families or from single-ended TTL or CMOS. The low noise, high gain ENC and ENC inputs may also be driven by a sinusoidal signal without degrading performance. A separate output power supply can be operated from 0.5V to 5V, making it easy to connect directly to any low voltage DSPs or FIFOs.

The 48-pin TSSOP package with a flow-through pinout simplifies the board layout.

LT, LTC and LT are registered trademarks of Linear Technology Corporation.

BLOCK DIAGRAM

80Mps, 14-Bit ADC with a 2.25V Differential Input Range

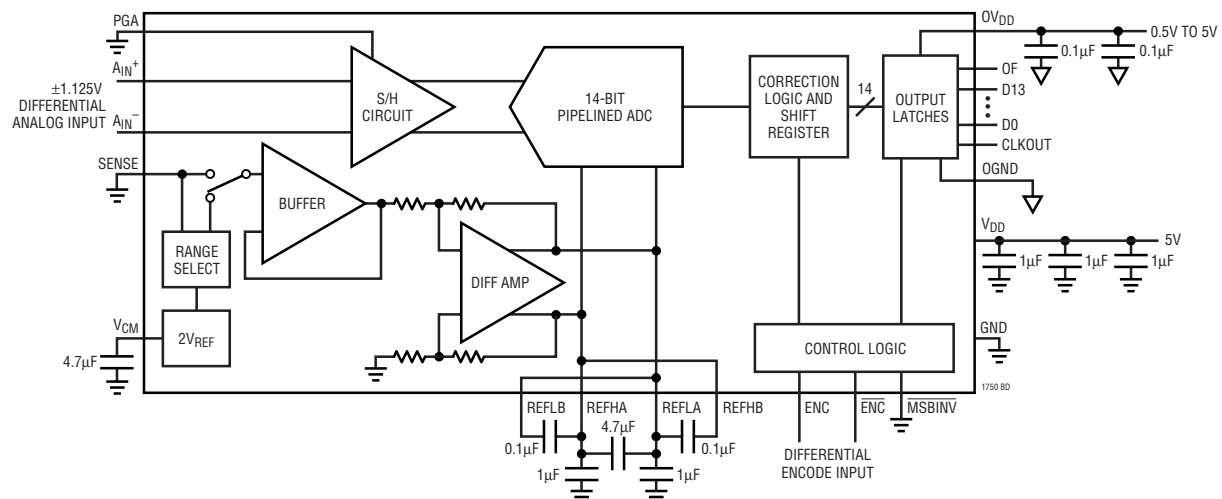

ABSOLUTE MAXIMUM RATINGS

$0V_{DD} = V_{DD}$ (Notes 1, 2)

Supply Voltage (V_{DD})	5.5V
Analog Input Voltage (Note 3)	-0.3V to ($V_{DD} + 0.3V$)
Digital Input Voltage (Note 4)	-0.3V to ($V_{DD} + 0.3V$)
Digital Output Voltage	-0.3V to ($V_{DD} + 0.3V$)
OGND Voltage	-0.3V to 1V
Power Dissipation	2000mW
Operating Temperature Range	
LTC1750C	0°C to 70°C
LTC1750I	-40°C to 85°C
Storage Temperature Range	-65°C to 150°C
Lead Temperature (Soldering, 10 sec)	300°C

PACKAGE/ORDER INFORMATION

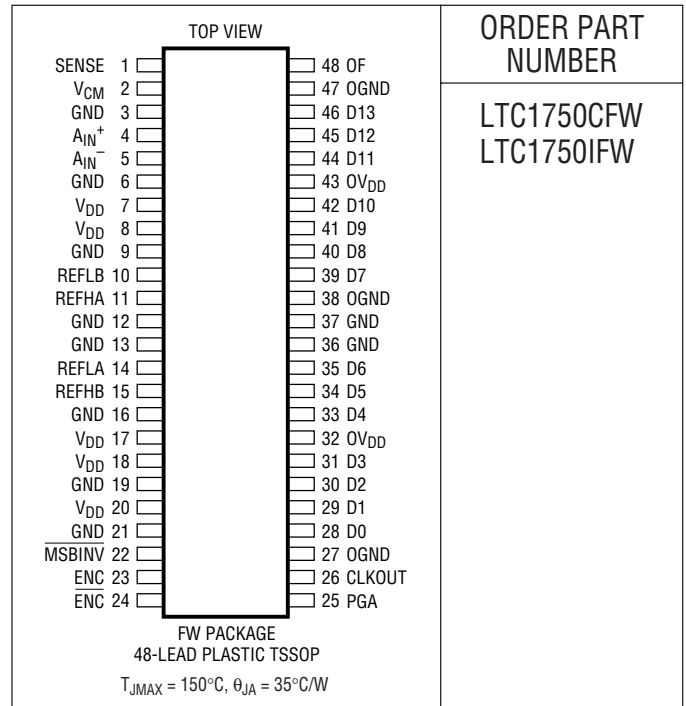

ORDER PART NUMBER

LTC1750CFW
LTC1750IFW

Consult LTC Marketing for parts specified with wider operating temperature ranges.

CONVERTER CHARACTERISTICS

The ● indicates specifications which apply over the full operating temperature range, otherwise specifications are at $T_A = 25^\circ\text{C}$. (Note 5)

PARAMETER	CONDITIONS	MIN	TYP	MAX	UNITS	
Resolution (No Missing Codes)		●	14		Bits	
Integral Linearity Error	(Note 6)	-3	±0.75	3	LSB	
Differential Linearity Error		●	-1	±0.5	1.5	LSB
Offset Error	(Note 7) External Reference ($V_{SENSE} = 1.125V$, $PGA = 0$)	-35	±8	35	mV	
Gain Error	External Reference ($V_{SENSE} = 1.125V$, $PGA = 0$)	-3.5	±1	3.5	%FS	
Full-Scale Tempco	Internal Reference		±40		ppm/°C	
	External Reference ($V_{SENSE} = 1.125V$)		±20		ppm/°C	
Offset Tempco			±20		µV/°C	
Input Referred Noise (Transition Noise)	$V_{SENSE} = 1.125V$, $PGA = 0$		0.92		LSB _{RMS}	

ANALOG INPUT

The ● indicates specifications which apply over the full operating temperature range, otherwise specifications are at $T_A = 25^\circ\text{C}$. (Note 5)

SYMBOL	PARAMETER	CONDITIONS	MIN	TYP	MAX	UNITS
V_{IN}	Analog Input Range (Note 8)	$4.75V \leq V_{DD} \leq 5.25V$	●	±0.7 to ±1.125		V
I_{IN}	Analog Input Leakage Current	$0 < A_{IN}^+, A_{IN}^- < V_{DD}$	●	-1	1	µA
C_{IN}	Analog Input Capacitance	Sample Mode $ENC < \bar{ENC}$ Hold Mode $ENC > \bar{ENC}$		6.9		pF
				2.4		pF
t_{ACQ}	Sample-and-Hold Acquisition Time		●	5	6	ns
t_{AP}	Sample-and-Hold Acquisition Delay Time			0		ns
t_{JITTER}	Sample-and-Hold Acquisition Delay Time Jitter			0.12		ps _{RMS}
CMRR	Analog Input Common Mode Rejection Ratio	$1.5V < (A_{IN}^- = A_{IN}^+) < 3V$		80		dB

1750f

DYNAMIC ACCURACY $T_A = 25^\circ\text{C}$, $A_{IN} = -1\text{dBFS}$ (Note 5), $V_{SENSE} = V_{DD}$

SYMBOL	PARAMETER	CONDITIONS	MIN	TYP	MAX	UNITS
SNR	Signal-to-Noise Ratio	5MHz Input Signal (PGA = 0)		75.5		dB
		5MHz Input Signal (PGA = 1)		73.0		dB
		30MHz Input Signal (PGA = 0)	73	75.3		dB
		30MHz Input Signal (PGA = 1)		72.9		dB
		70MHz Input Signal (PGA = 0)	70	74.6		dB
		70MHz Input Signal (PGA = 1)		72.8		dB
		140MHz Input Signal (PGA = 1)		72		dB
SFDR	Spurious Free Dynamic Range	5MHz Input Signal (PGA = 0)		90		dB
		5MHz Input Signal (PGA = 1)		90		dB
		30MHz Input Signal (PGA = 0) (HD2 and HD3)	80	90		dB
		30MHz Input Signal (PGA = 0) Other	85	95		dB
		30MHz Input Signal (PGA = 1)		90		dB
		70MHz Input Signal (PGA = 0)		85		dB
		70MHz Input Signal (PGA = 1) (HD2 and HD3)	80	90		dB
		70MHz Input Signal (PGA = 1) Other	83	95		dB
		140MHz Input Signal (PGA = 1)		84		dB
		250MHz Input Signal (PGA = 1)		82		dB
S/(N + D)	Signal-to-(Noise + Distortion) Ratio	5MHz Input Signal (PGA = 0)		75.2		dB
		5MHz Input Signal (PGA = 1)		72.8		dB
		30MHz Input Signal (PGA = 0)		75.1		dB
		30MHz Input Signal (PGA = 1)		72.6		dB
		70MHz Input Signal (PGA = 0)		74.3		dB
		70MHz Input Signal (PGA = 1)		72.4		dB
		250MHz Input Signal (PGA = 1)		70		dB
THD	Total Harmonic Distortion	5MHz Input Signal, First 5 Harmonics (PGA = 0)		-90		dB
		5MHz Input Signal, First 5 Harmonics (PGA = 1)		-90		dB
		30MHz Input Signal, First 5 Harmonics (PGA = 0)		-90		dB
		30MHz Input Signal, First 5 Harmonics (PGA = 1)		-90		dB
		70MHz Input Signal, First 5 Harmonics (PGA = 0)		-85		dB
		70MHz Input Signal, First 5 Harmonics (PGA = 1)		-90		dB
IMD	Intermodulation Distortion	$f_{IN1} = 2.52\text{MHz}$, $f_{IN2} = 5.2\text{MHz}$ (PGA = 0)		-90		dBc
		$f_{IN1} = 2.52\text{MHz}$, $f_{IN2} = 5.2\text{MHz}$ (PGA = 1)		-90		dBc
	Sample-and-Hold Bandwidth	$R_{SOURCE} = 50\Omega$		500		MHz

INTERNAL REFERENCE CHARACTERISTICS (Note 5)

PARAMETER	CONDITIONS	MIN	TYP	MAX	UNITS
V_{CM} Output Voltage	$I_{OUT} = 0$	1.95	2	2.05	V
V_{CM} Output Tempco	$I_{OUT} = 0$		± 30		ppm/ $^\circ\text{C}$
V_{CM} Line Regulation	$4.75\text{V} \leq V_{DD} \leq 5.25\text{V}$		3		mV/V
V_{CM} Output Resistance	$1\text{mA} \leq I_{OUT} \leq 1\text{mA}$		4		Ω

1750f

DIGITAL INPUTS AND DIGITAL OUTPUTS

The ● indicates specifications which apply over the full operating temperature range, otherwise specifications are at $T_A = 25^\circ\text{C}$. (Note 5)

SYMBOL	PARAMETER	CONDITIONS	MIN	TYP	MAX	UNITS
V_{IH}	High Level Input Voltage	$V_{DD} = 5.25\text{V}$, MSBINV and PGA	● 2.4			V
V_{IL}	Low Level Input Voltage	$V_{DD} = 4.75\text{V}$, MSBINV and PGA	●		0.8	V
I_{IN}	Digital Input Current	$V_{IN} = 0\text{V}$ to V_{DD}	●		± 10	μA
C_{IN}	Digital Input Capacitance	MSBINV and PGA Only		1.5		pF
V_{OH}	High Level Output Voltage	$OV_{DD} = 4.75\text{V}$		4.74		V
		$I_O = -10\mu\text{A}$				
V_{OL}	Low Level Output Voltage	$OV_{DD} = 4.75\text{V}$		0.05		V
		$I_O = -200\mu\text{A}$	● 4	4.74		V
I_{SOURCE}	Output Source Current	$V_{OUT} = 0\text{V}$		-50		mA
		$V_{OUT} = 5\text{V}$		50		mA
I_{SINK}	Output Sink Current	$V_{OUT} = 5\text{V}$				mA

POWER REQUIREMENTS

The ● indicates specifications which apply over the full operating temperature range, otherwise specifications are at $T_A = 25^\circ\text{C}$. (Note 5)

SYMBOL	PARAMETER	CONDITIONS	MIN	TYP	MAX	UNITS
V_{DD}	Positive Supply Voltage		4.75		5.25	V
I_{DD}	Positive Supply Current		●	290	338	mA
P_{DIS}	Power Dissipation		●	1.45	1.69	W
OV_{DD}	Digital Output Supply Voltage		0.5		V_{DD}	V

TIMING CHARACTERISTICS

The ● indicates specifications which apply over the full operating temperature range, otherwise specifications are at $T_A = 25^\circ\text{C}$. (Note 5)

SYMBOL	PARAMETER	CONDITIONS	MIN	TYP	MAX	UNITS
t_0	ENC Period	(Note 9)	● 12.5		2000	ns
t_1	ENC High	(Note 8)	● 6		1000	ns
t_2	ENC Low	(Note 8)	● 6		1000	ns
t_3	Aperture Delay	(Note 8)		0		ns
t_4	ENC to CLKOUT Falling	$C_L = 10\text{pF}$ (Note 8)	● 1	2.4	4	ns
t_5	ENC to CLKOUT Rising	$C_L = 10\text{pF}$ (Note 8)		$t_1 + t_4$		ns
	For 80Msps 50% Duty Cycle	$C_L = 10\text{pF}$ (Note 8)	● 7.25	8.65	10.25	ns
t_6	ENC to DATA Delay	$C_L = 10\text{pF}$ (Note 8)	● 2	4.9	7.2	ns
t_7	ENC to DATA Delay (Hold Time)	(Note 8)	● 1.4	3.4	4.7	ns
t_8	ENC to DATA Delay (Setup Time)	$C_L = 10\text{pF}$ (Note 8)		$t_0 - t_6$		ns
	For 80Msps 50% Duty Cycle	$C_L = 10\text{pF}$ (Note 8)	● 5.3	7.6	10.5	ns
t_9	CLKOUT to DATA Delay (Hold Time), 80Msps 50% Duty Cycle	(Note 8)	● 6			ns
t_{10}	CLKOUT to DATA Delay (Setup Time), 80Msps 50% Duty Cycle	$C_L = 10\text{pF}$ (Note 8)	● 2.1			ns
	Data Latency			5		cycles

ELECTRICAL CHARACTERISTICS

Note 1: Absolute Maximum Ratings are those values beyond which the life of a device may be impaired.

Note 2: All voltage values are with respect to GND (unless otherwise noted).

Note 3: When these pin voltages are taken below GND or above V_{DD} , they will be clamped by internal diodes. This product can handle input currents of greater than 100mA below GND or above V_{DD} without latching.

Note 4: When these pin voltages are taken below GND, they will be clamped by internal diodes. This product can handle input currents of >100mA below GND without latching. These pins are not clamped to V_{DD} .

Note 5: $V_{DD} = 5V$, $f_{SAMPLE} = 80MHz$, differential $\overline{ENC/ENC} = 2V_{p-p}$ 80MHz sine wave, input range = $\pm 1.125V$ differential, unless otherwise specified.

Note 6: Integral nonlinearity is defined as the deviation of a code from a straight line passing through the actual endpoints of the transfer curve. The deviation is measured from the center of the quantization band.

Note 7: Bipolar offset is the offset voltage measured from -0.5 LSB when the output code flickers between 00 0000 0000 0000 and 11 1111 1111 1111.

Note 8: Guaranteed by design, not subject to test.

Note 9: Recommended operating conditions.

TYPICAL PERFORMANCE CHARACTERISTICS

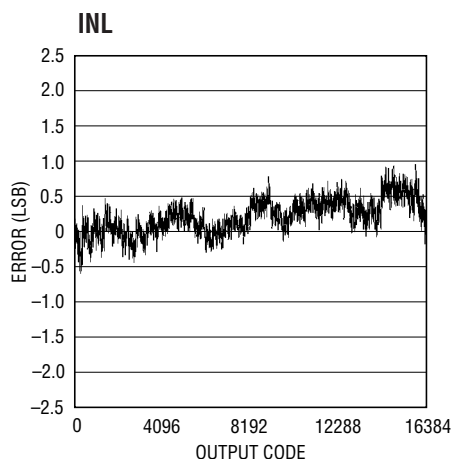

1750 G01

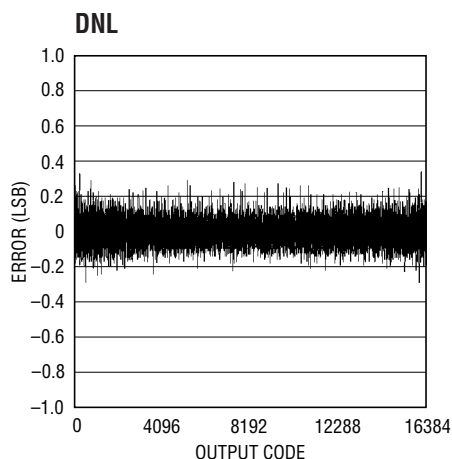

1750 G02

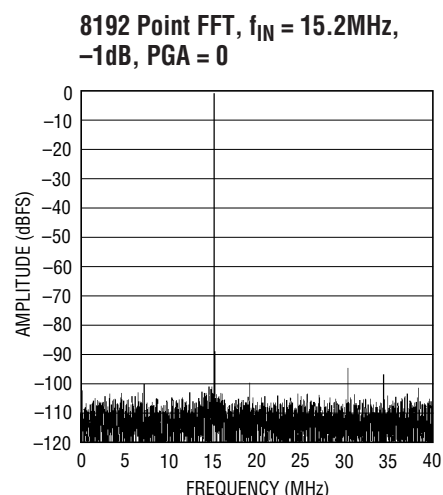

1750 G03

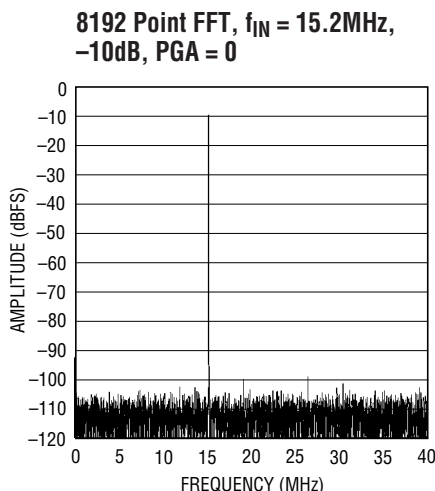

1750 G04

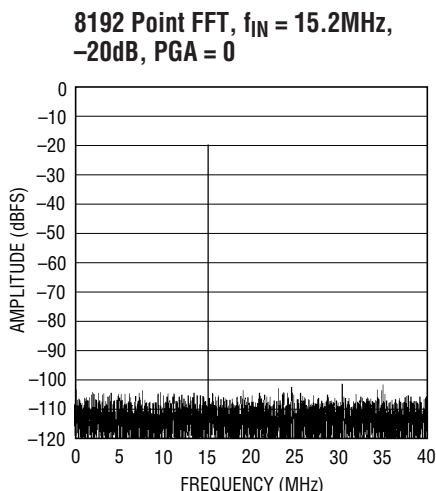

1750 G05

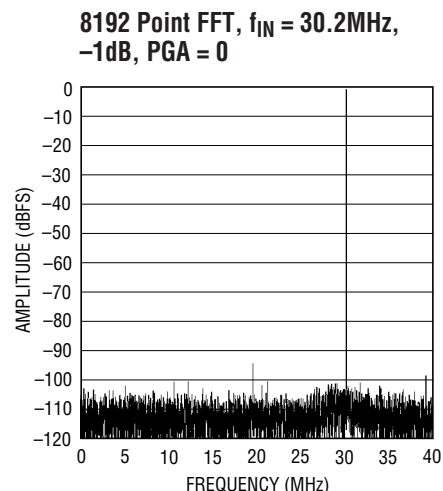

1750 G06

TYPICAL PERFORMANCE CHARACTERISTICS

**8192 Point FFT, $f_{IN} = 30.2\text{MHz}$,
-10dB, PGA = 0**

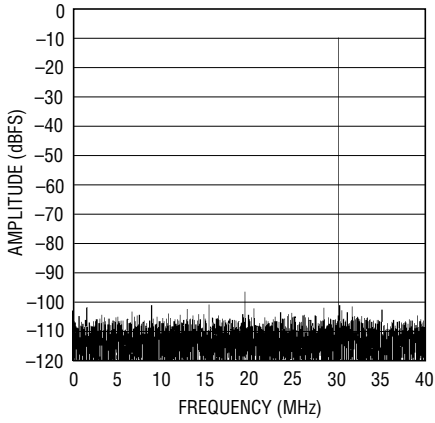

1750 G07

**8192 Point FFT, $f_{IN} = 30.2\text{MHz}$,
-20dB, PGA = 0**

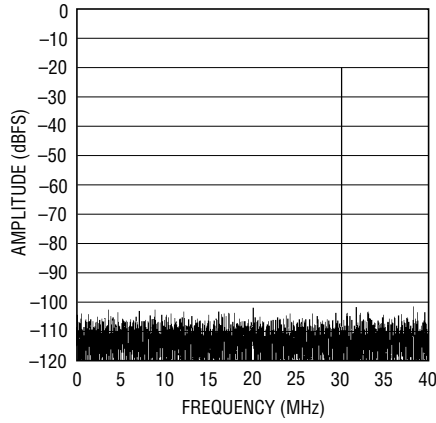

1750 G08

**8192 Point FFT, $f_{IN} = 70.2\text{MHz}$,
-1dB, PGA = 0**

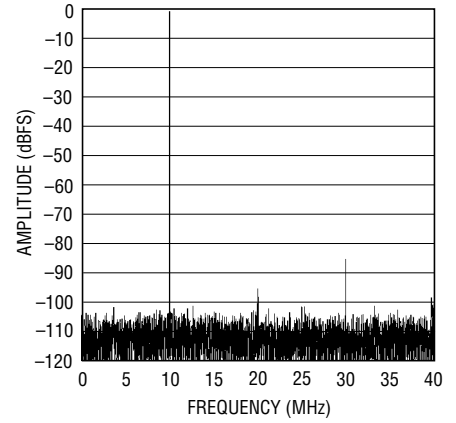

1750 G09

**8192 Point FFT, $f_{IN} = 70.2\text{MHz}$,
-10dB, PGA = 0**

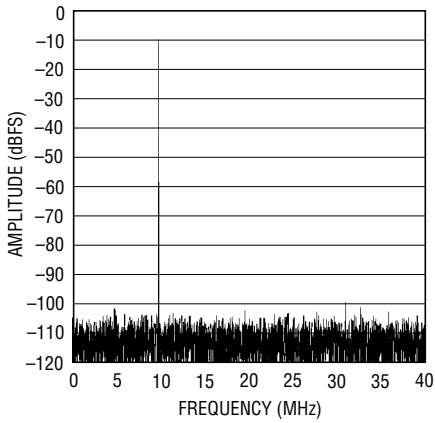

1750 G10

**8192 Point FFT, $f_{IN} = 70.2\text{MHz}$,
-20dB, PGA = 0**

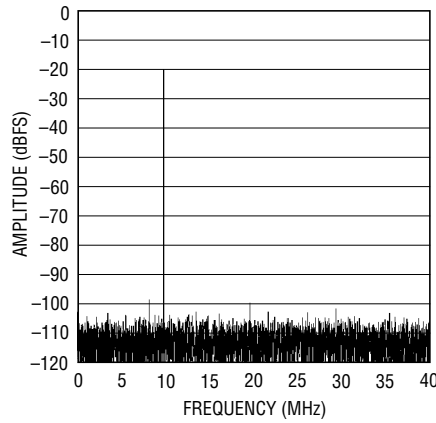

1750 G11

**8192 Point FFT, $f_{IN} = 140.2\text{MHz}$,
-1dB, PGA = 1**

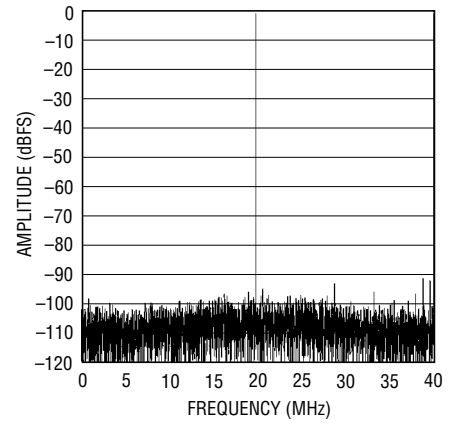

1750 G12

**8192 Point FFT, $f_{IN} = 140.2\text{MHz}$,
-10dB, PGA = 1**

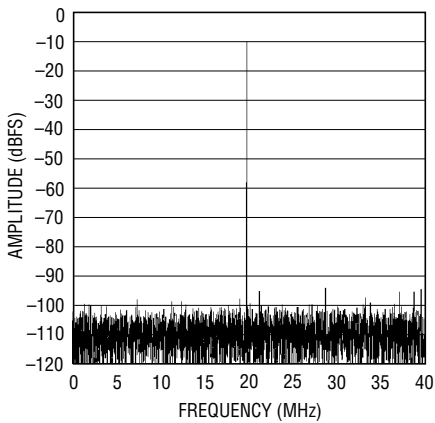

1750 G13

**8192 Point FFT, $f_{IN} = 140.2\text{MHz}$,
-20dB, PGA = 1**

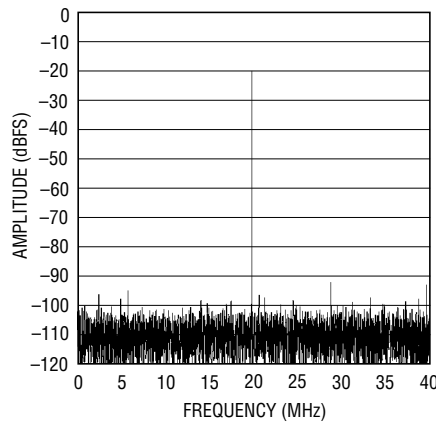

1750 G14

**8192 Point FFT, $f_{IN} = 250.2\text{MHz}$,
-1dB, PGA = 1**

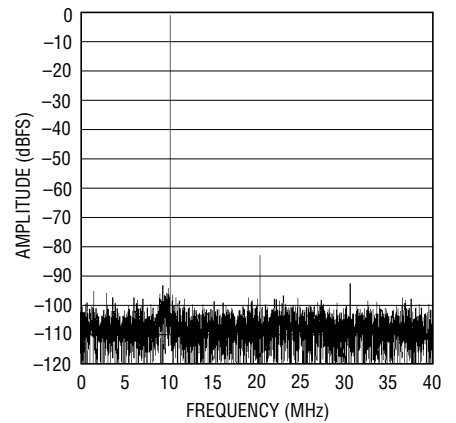

1750 G15

TYPICAL PERFORMANCE CHARACTERISTICS

8192 Point FFT, $f_{IN} = 250.2\text{MHz}$,
-10dB, PGA = 1

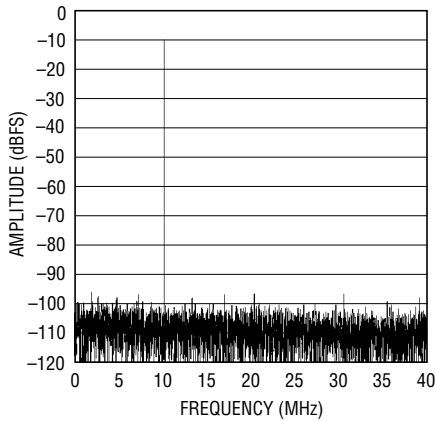

1750 G16

8192 Point FFT, $f_{IN} = 250.2\text{MHz}$,
-20dB, PGA = 1

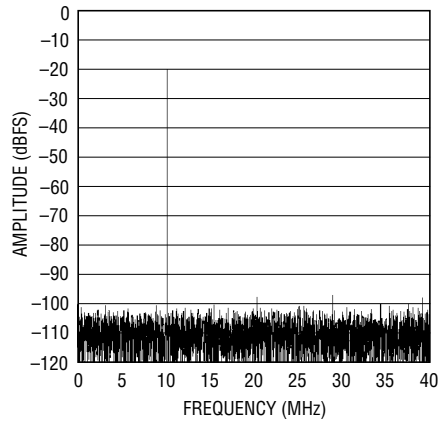

1750 G17

8192 Point 2-Tone FFT,
 $f_{IN} = 26.4\text{MHz}$ and 27.5MHz ,
-7dB Each Tone, PGA = 1

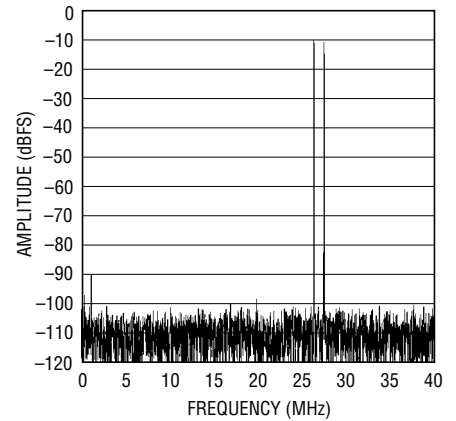

1750 G18

8192 Point 2-Tone FFT,
 $f_{IN} = 69.4\text{MHz}$ and 65.2MHz ,
-7dB Each Tone, PGA = 1

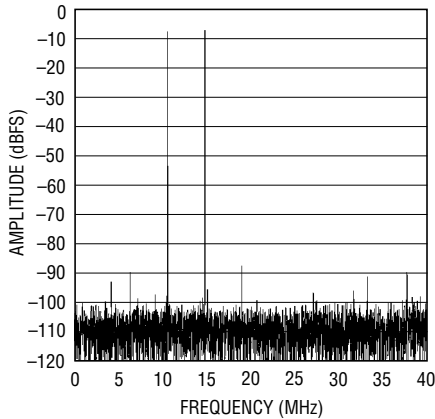

1750 G19

SFDR vs 15MHz Input Level

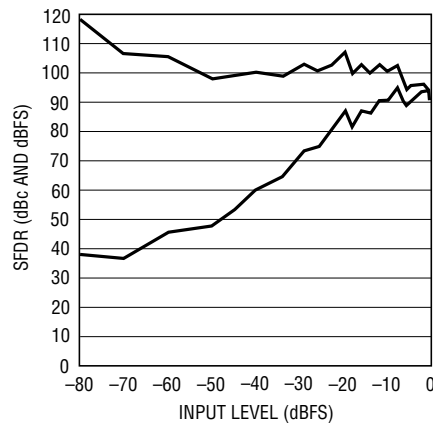

1750 G20

SFDR vs 40.2MHz Input Level

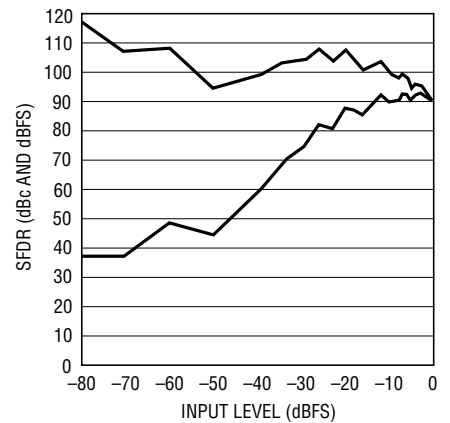

1750 G21

SFDR vs 140.2MHz Input Level,
PGA = 0

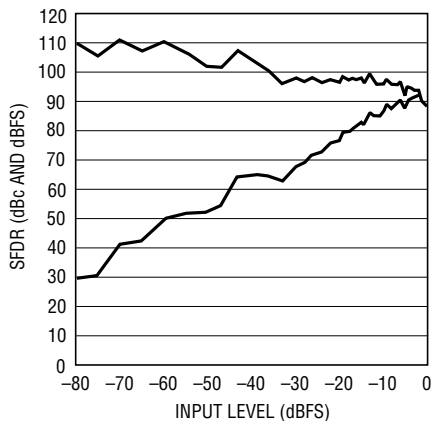

1750 G22

SFDR vs 250.2MHz Input Level,
PGA = 0

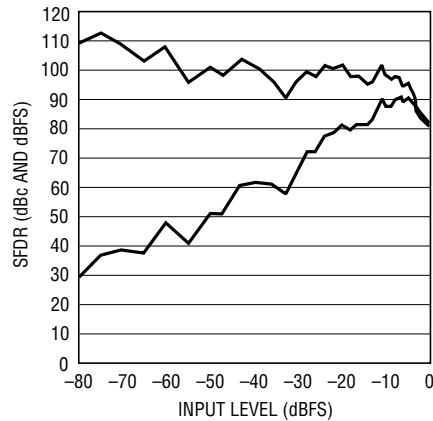

1750 G23

SNR vs Input Frequency and
Amplitude, PGA = 0

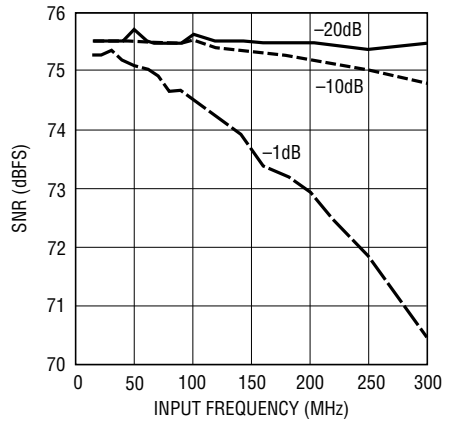

1750 G24

TYPICAL PERFORMANCE CHARACTERISTICS

SNR vs Input Frequency and Amplitude, PGA = 1

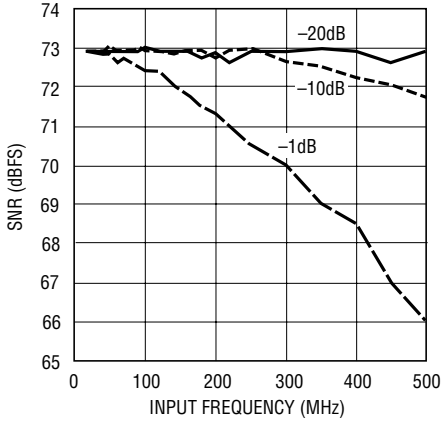

1750 G25

SFDR (HD2 and HD3) vs Input Frequency and Amplitude, PGA = 0

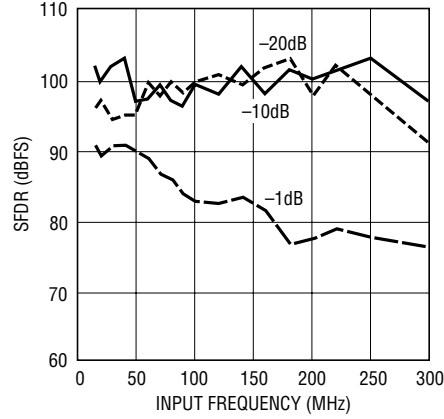

1750 G26

SFDR (HD2 and HD3) vs Input Frequency and Amplitude, PGA = 1

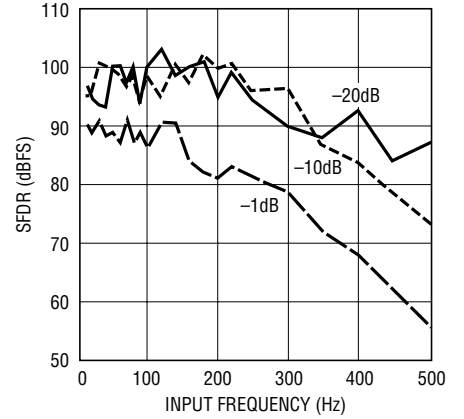

1750 G27

SFDR and SNR vs Sample Rate, 15.2MHz, -1dB Input

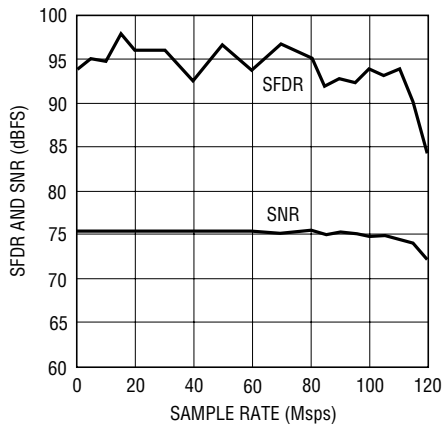

1750 G28

SFDR and SNR vs V_{DD}, 15.2MHz, -1dB Input

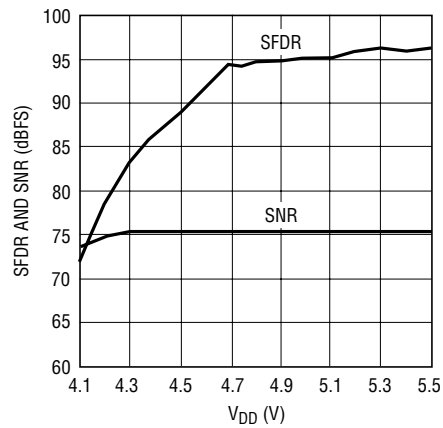

1750 G29

PIN FUNCTIONS

SENSE (Pin 1): Reference Sense Pin. GND selects a V_{REF} of 0.7V. V_{DD} selects 1.125V. When V_{SENSE} is between 0.7V and 1.125V, V_{SENSE} is used as V_{REF} . The ADC input range is $\pm V_{REF}/PGA$ gain.

V_{CM} (Pin 2): 2.0V Output and Input Common Mode Bias. Bypass to ground with 4.7 μ F ceramic chip capacitor.

GND (Pins 3, 6, 9, 12, 13, 16, 19, 21, 36, 37): ADC Power Ground.

A_{IN}^+ (Pin 4): Positive Differential Analog Input.

A_{IN}^- (Pin 5): Negative Differential Analog Input.

V_{DD} (Pins 7, 8, 17, 18, 20): 5V Supply. Bypass to AGND with 1 μ F ceramic chip capacitors at Pin 8 and Pin 18.

REFLB (Pin 10): ADC Low Reference. Bypass to Pin 11 with 0.1 μ F ceramic chip capacitor. Do not connect to Pin 14.

REFHA (Pin 11): ADC High Reference. Bypass to Pin 10 with 0.1 μ F ceramic chip capacitor, to Pin 14 with a 4.7 μ F ceramic capacitor and to ground with 1 μ F ceramic capacitor.

REFLA (Pin 14): ADC Low Reference. Bypass to Pin 15 with 0.1 μ F ceramic chip capacitor, to Pin 11 with a 4.7 μ F ceramic capacitor and to ground with 1 μ F ceramic capacitor.

REFHB (Pin 15): ADC High Reference. Bypass to Pin 14 with 0.1 μ F ceramic chip capacitor. Do not connect to Pin 11.

MSBINV (Pin 22): MSB Inversion Control. Low inverts the MSB, 2's complement output format. High does not invert the MSB, offset binary output format.

ENC (Pin 23): Encode Input. The input sample starts on the positive edge.

ENC (Pin 24): Encode Complement Input. Conversion starts on the negative edge. Bypass to ground with 0.1 μ F ceramic for single-ended ENCODE signal.

PGA (Pin 25): Programmable Gain Amplifier Control. Low selects an effective front-end gain of 1. High selects an effective gain of 1 2/3. The ADC input range is $\pm V_{REF}/PGA$ gain.

CLKOUT (Pin 26): Data Valid Output. Latch data on the rising edge of CLKOUT.

OGND (Pins 27, 38, 47): Output Driver Ground.

D0-D3 (Pins 28 to 31): Digital Outputs.

OV_{DD} (Pins 32, 43): Positive Supply for the Output Drivers. Bypass to ground with 0.1 μ F ceramic chip capacitor.

D4-D6 (Pins 33 to 35): Digital Outputs.

D7-D10 (Pins 39 to 42): Digital Outputs.

D11-D13 (Pins 44 to 46): Digital Outputs.

OF (Pin 48): Over/Under Flow Output. High when an over or under flow has occurred.

TIMING DIAGRAM

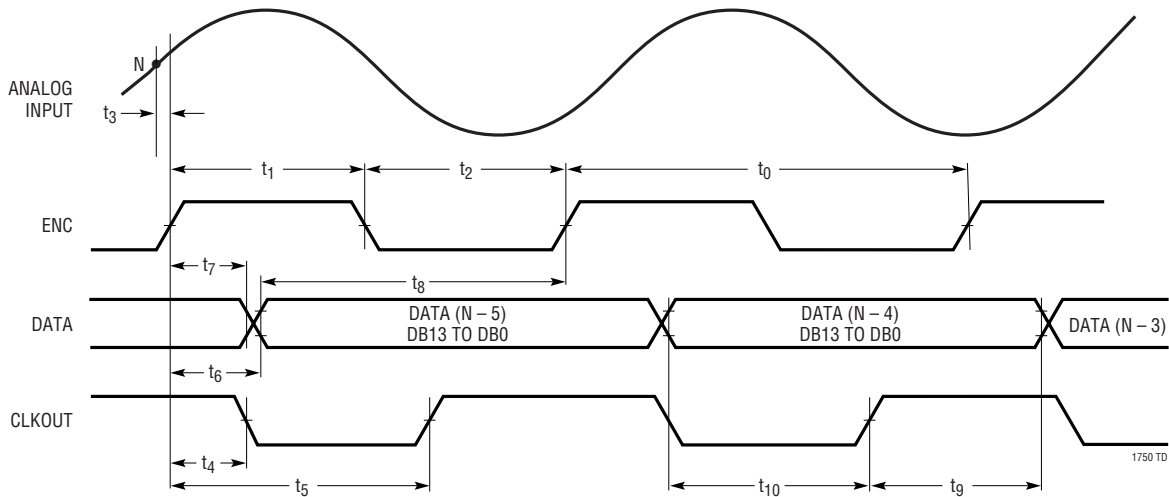

APPLICATIONS INFORMATION

DYNAMIC PERFORMANCE

Signal-to-Noise Plus Distortion Ratio

The signal-to-noise plus distortion ratio [S/(N + D)] is the ratio between the RMS amplitude of the fundamental input frequency and the RMS amplitude of all other frequency components at the ADC output. The output is band limited to frequencies above DC to below half the sampling frequency.

Signal-to-Noise Ratio

The signal-to-noise ratio (SNR) is the ratio between the RMS amplitude of the fundamental input frequency and the RMS amplitude of all other frequency components except the first five harmonics and DC.

Total Harmonic Distortion

Total harmonic distortion is the ratio of the RMS sum of all harmonics of the input signal to the fundamental itself. The out-of-band harmonics alias into the frequency band between DC and half the sampling frequency. THD is expressed as:

$$\text{THD} = 20\text{Log} \frac{\sqrt{V_2^2 + V_3^2 + V_4^2 + \dots + V_n^2}}{V_1}$$

where V_1 is the RMS amplitude of the fundamental frequency and V_2 through V_n are the amplitudes of the second through nth harmonics. The THD calculated in this data sheet uses all the harmonics up to the fifth.

Intermodulation Distortion

If the ADC input signal consists of more than one spectral component, the ADC transfer function nonlinearity can produce intermodulation distortion (IMD) in addition to THD. IMD is the change in one sinusoidal input caused by the presence of another sinusoidal input at a different frequency.

If two pure sine waves of frequencies f_a and f_b are applied to the ADC input, nonlinearities in the ADC transfer function can create distortion products at the sum and difference frequencies of $m f_a \pm n f_b$, where m and $n = 0, 1, 2, 3$, etc. The 3rd order intermodulation products are $2f_a + f_b$, $2f_b + f_a$, $2f_a - f_b$ and $2f_b - f_a$. The intermodulation distortion is defined as the ratio of the RMS value of either input tone to the RMS value of the largest 3rd order intermodulation product.

APPLICATIONS INFORMATION

Spurious Free Dynamic Range (SFDR)

Spurious free dynamic range is the peak harmonic or spurious noise that is the largest spectral component excluding the input signal and DC. This value is expressed in decibels relative to the RMS value of a full scale input signal.

Input Bandwidth

The input bandwidth is that input frequency at which the amplitude of the reconstructed fundamental is reduced by 3dB for a full scale input signal.

Aperture Delay Time

The time from when a rising \overline{ENC} equals the \overline{ENC} voltage to the instant that the input signal is held by the sample and hold circuit.

Aperture Delay Jitter

The variation in the aperture delay time from conversion to conversion. This random variation will result in noise

when sampling an AC input. The signal to noise ratio due to the jitter alone will be:

$$SNR_{JITTER} = -20 \log(2\pi) \cdot F_{IN} \cdot T_{JITTER}$$

CONVERTER OPERATION

The LTC1750 is a CMOS pipelined multistep converter with a front-end PGA. The converter has four pipelined ADC stages; a sampled analog input will result in a digitized value five cycles later, see the Timing Diagram section. The analog input is differential for improved common mode noise immunity and to maximize the input range. Additionally, the differential input drive will reduce even order harmonics of the sample-and-hold circuit. The encode input is also differential for improved common mode noise immunity.

The LTC1750 has two phases of operation, determined by the state of the differential $\overline{ENC}/\overline{ENC}$ input pins. For brevity, the text will refer to \overline{ENC} greater than \overline{ENC} as \overline{ENC} high and \overline{ENC} less than \overline{ENC} as \overline{ENC} low.

Each pipelined stage shown in Figure 1 contains an ADC, a reconstruction DAC and an interstage residue amplifier.

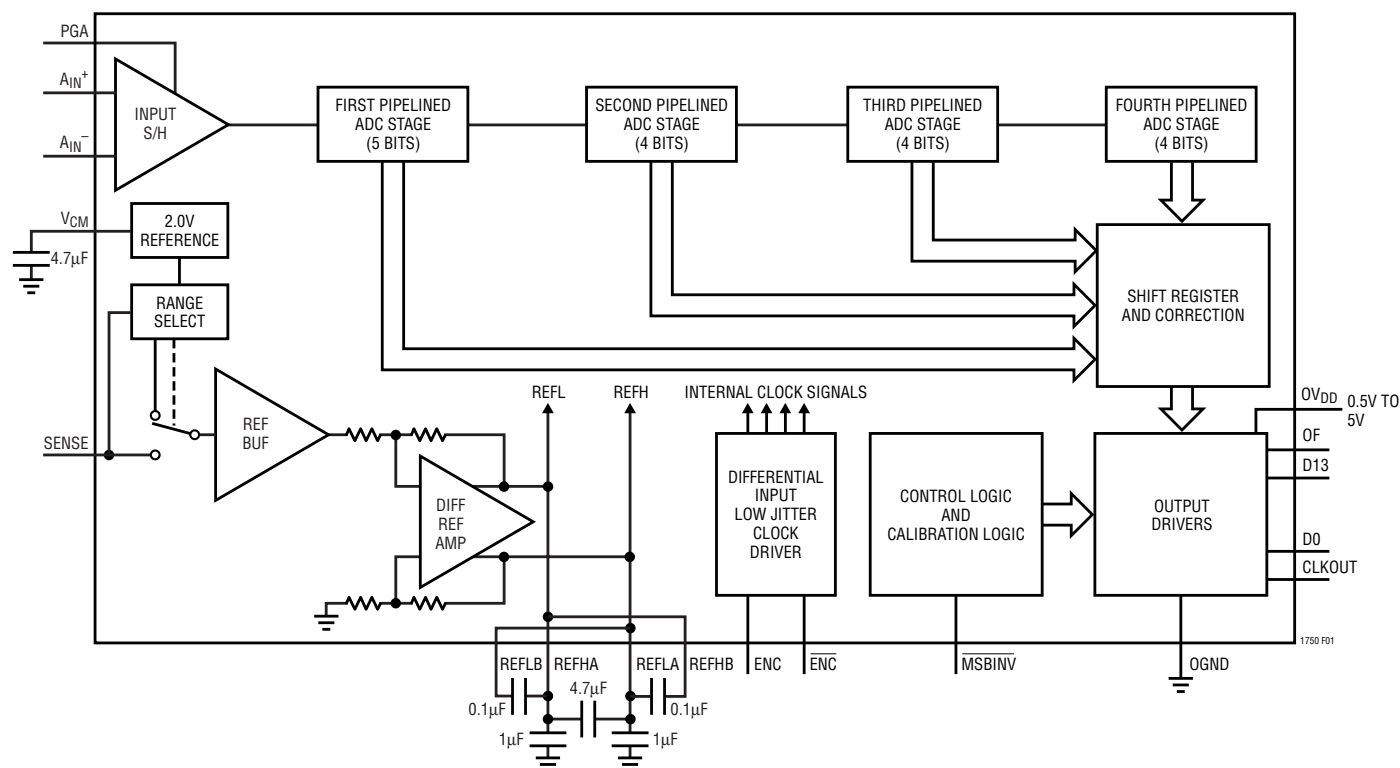

Figure 1. Functional Block Diagram

APPLICATIONS INFORMATION

In operation, the ADC quantizes the input to the stage and the quantized value is subtracted from the input by the DAC to produce a residue. The residue is amplified and output by the residue amplifier. Successive stages operate out of phase so that when the odd stages are outputting their residue, the even stages are acquiring that residue and visa versa.

When ENC is low, the analog input is sampled differentially directly onto the input sample-and-hold capacitors, inside the “Input S/H” shown in the block diagram. At the instant that ENC transitions from low to high, the sampled input is held. While ENC is high, the held input voltage is buffered by the S/H amplifier which drives the first pipelined ADC stage. The first stage acquires the output of the S/H during this high phase of ENC. When ENC goes back low, the first stage produces its residue which is acquired by the second stage. At the same time, the input S/H goes back to acquiring the analog input. When ENC goes back high, the second stage produces its residue which is acquired by the third stage. An identical process is repeated for the third stage, resulting in a third stage residue that is sent to the fourth stage ADC for final evaluation.

Each ADC stage following the first has additional range to accommodate flash and amplifier offset errors. Results from all of the ADC stages are digitally synchronized such that the results can be properly combined in the correction logic before being sent to the output buffer.

SAMPLE/HOLD OPERATION AND INPUT DRIVE

Sample/Hold Operation

Figure 2 shows an equivalent circuit for the LTC1750 CMOS differential sample-and-hold. The differential analog inputs are sampled directly onto sampling capacitors (C_{SAMPLE}) through NMOS switches. This direct capacitor sampling results in lowest possible noise for a given sampling capacitor size. The capacitors shown attached to each input ($C_{\text{PARASITIC}}$) are the summation of all other capacitance associated with each input.

During the sample phase when $\overline{\text{ENC}}/\overline{\text{ENC}}$ is low, the NMOS switch connects the analog inputs to the sampling capacitors and they charge to, and track the differential input voltage. When ENC/ENC transitions from low to high the

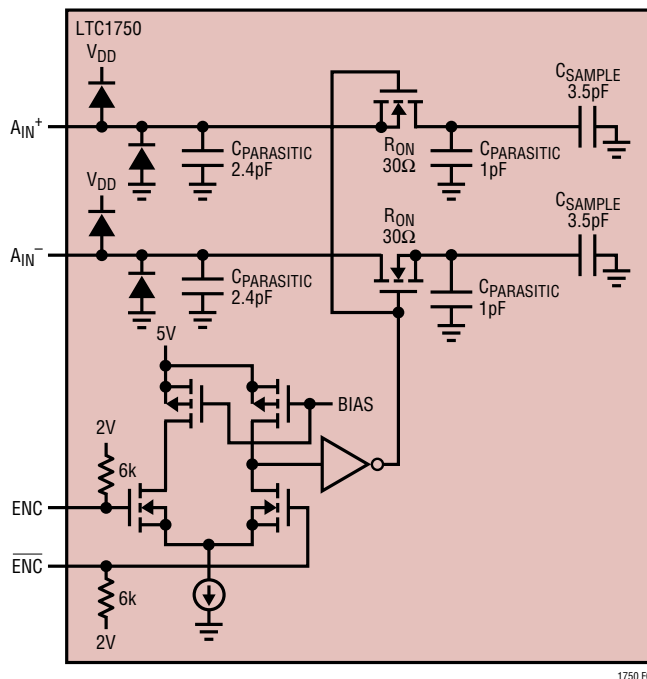

Figure 2. Equivalent Input Circuit

sampled input voltage is held on the sampling capacitors. During the hold phase when ENC/ENC is high the sampling capacitors are disconnected from the input and the held voltage is passed to the ADC core for processing. As ENC/ENC transitions from high to low the inputs are reconnected to the sampling capacitors to acquire a new sample. Since the sampling capacitors still hold the previous sample, a charging glitch proportional to the change in voltage between samples will be seen at this time. If the change between the last sample and the new sample is small the charging glitch seen at the input will be small. If the input change is large, such as the change seen with input frequencies near Nyquist, then a larger charging glitch will be seen.

Common Mode Bias

The ADC sample-and-hold circuit requires differential drive to achieve specified performance. Each input should swing within the valid input range, around a common mode voltage of 2.0V. The V_{CM} output pin (Pin 2) may be used to provide the common mode bias level. V_{CM} can be tied directly to the center tap of a transformer to set the DC input level or as a reference level to an op amp differential driver circuit. The V_{CM} pin must be bypassed to ground close to the ADC with a 4.7 μF or greater capacitor.

APPLICATIONS INFORMATION

Input Drive Circuits

The LTC1750 requires differential drive for the analog inputs. A balanced input drive will minimize even order harmonics that are due to nonlinear behavior of the input drive circuits and the S/H circuit.

The S/H circuit of the LTC1750 is a switched capacitor circuit (Figure 2). The input drive circuitry will see a sampling glitch at the start of the sampling period, when ENC/ENC falls. Although designed to be linear as possible, a small fraction of this glitch is nonlinear and can result in additional observed distortion if the input drive circuitry is too slow. For most practical circuits the glitch nonlinearity is more than 100dB below the fundamental. The glitch will decay during the sampling period with a time constant determined by the input drive and S/H circuitry.

For fast settling and wide bandwidth, a low drive impedance is required. The S/H bandwidth is partially determined by the source impedance. The full 500MHz bandwidth is valid for source impedance (each input) less than 30Ω . Higher source impedance can be used but full amplitude distortion will be better with source impedance less than 100Ω .

Transformers

Transformers provide a simple method for converting a single-ended signal to a differential signal; however, they have poor performance characteristics at low and high input frequencies. The lower -3dB corner of RF transformers can range from tens of kHz to tens of MHz. Operation near this corner results in poor 2nd order harmonic performance due to nonlinear transformer core behavior. The upper -3dB corner can vary from tens of MHz to several GHz. Operation near the upper corner can result in poor 2nd order performance due to poor balance on the secondary.

Transformers should be selected to have -3dB corners at least one octave away from the desired operating frequency. Transformers with larger cores usually have better performance at lower frequency and perform better when driving heavy loads.

Figure 3a shows the LTC1750 being driven by an RF transformer with a center tapped secondary. The secondary center tap is DC-biased with V_{CM} , setting the ADC input

signal at its optimum DC level of 2V. In this example a 1:1 transformer is used; however, other transformer impedance ratios may be substituted.

Figure 3b shows the use of a transformer without a center tapped secondary. In this example the secondary is biased with the addition of two resistors placed in series across the secondary winding. The center tap of the secondary resistors is connected to the ADC V_{CM} output to set the DC bias. This circuit is better suited for high input frequency applications since center tapped transformers generally have less bandwidth and poor balance at high frequencies than noncenter tapped transformers.

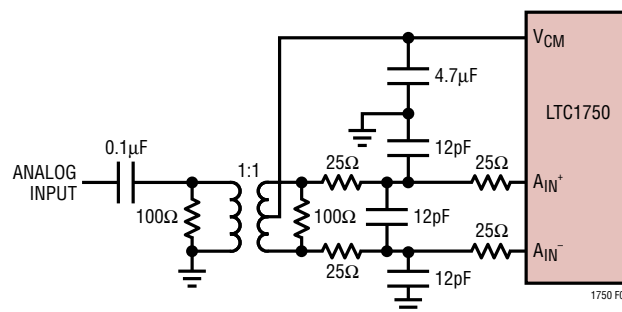

Figure 3a. Single-Ended to Differential Conversion Using a Transformer

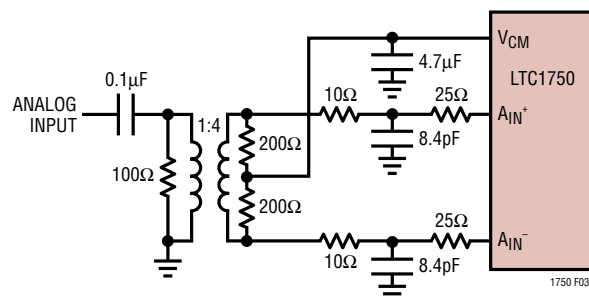

Figure 3b. Using a Transformer Without a Center Tapped Secondary

Active Drive Circuits

Active circuits, open loop or closed loop, can be used to drive the ADC inputs. Closed-loop circuits such as op amps have excellent DC and low frequency accuracy, but have poor high frequency performance. Figure 4 shows the dual LT[®]1818 op amp used for single-ended to differential

APPLICATIONS INFORMATION

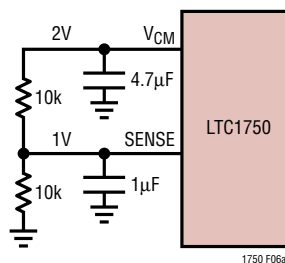

Figure 6a. 2V Range ADC

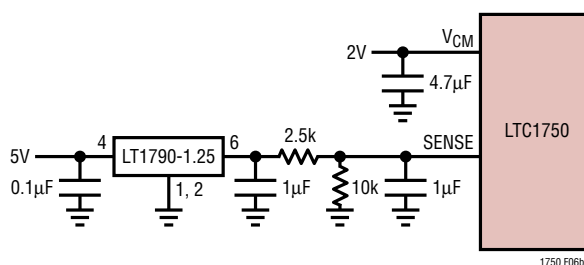

Figure 6b. 2V Range ADC with External Reference

Input Range

The LTC1750 performance may be optimized by adjusting the ADC's input range to meet the requirements of the application. For lower input frequency applications (<80MHz), the highest input range of $\pm 1.125V$ (2.25V) will provide the best SNR while maintaining excellent SFDR. For higher input frequencies (>80MHz), a lower input range will provide better SFDR performance with a reduction in SNR.

The input range of the ADC is determined as $\pm V_{REF}/A_{PGA}$, where V_{REF} is the reference voltage (described in the Reference Operation section) and A_{PGA} is the effective

PGA gain. Table 1 shows the input range of the ADC versus the state of the two pins, PGA and SENSE.

Driving the Encode Inputs

The noise performance of the LTC1750 can depend on the encode signal quality as much as on the analog input. The ENC/ENC inputs are intended to be driven differentially, primarily for noise immunity from common mode noise sources. Each input is biased through a 6k resistor to a 2V bias. The bias resistors set the DC operating point for transformer coupled drive circuits and can set the logic threshold for single-ended drive circuits.

Any noise present on the encode signal will result in additional aperture jitter that will be RMS summed with the inherent ADC aperture jitter.

In applications where jitter is critical (high input frequencies) take the following into consideration:

1. Differential drive should be used.
2. Use as large an amplitude as possible; if transformer coupled use a higher turns ratio to increase the amplitude.
3. If the ADC is clocked with a sinusoidal signal, filter the encode signal to reduce wideband noise.
4. Balance the capacitance and series resistance at both encode inputs so that any coupled noise will appear at both inputs as common mode noise.

The encode inputs have a common mode range of 1.8V to V_{DD} . Each input may be driven from ground to V_{DD} for single-ended drive.

Table 1

PGA	V_{SENSE}	INPUT RANGE	COMMENTS
0	$= V_{DD}$	2.25V _{p-p} Differential	Best Noise, SNR = 75.5dB. Good SFDR, >82dB Up to 100MHz
1	$= V_{DD}$	1.35V _{p-p} Differential	Improved High Frequency Distortion. SNR = 73dB. SFDR > 80dB Up to 250MHz
0	$= GND$	1.4V _{p-p} Differential	Reduced Internal Reference Mode with PGA = 0. Provides Similar Input Range as $V_{SENSE} = V_{DD}$ and PGA = 0 But with Worse Noise. SNR = 71.4dB
1	$= GND$	0.84V _{p-p} Differential	Smallest Possible Input Span. Useful for Improved Distortion at Very High Frequencies, But with Reduced Noise Performance. SNR = 69dB
0	$0.7V < V_{SENSE} < 1.125V$	$2 \times V_{SENSE}$ Peak-to-Peak Differential	Adjustable Input Range with Better Noise Performance. SNR = 75.5dB with $V_{SENSE} = 1.125V$, SNR = 71.4dB with $V_{SENSE} = 0.7V$
1	$0.7V < V_{SENSE} < 1.125V$	$1.2 \times V_{SENSE}$ Peak-to-Peak Differential	Adjustable Input Range with Better High Frequency Distortion. SNR = 73dB with $V_{SENSE} = 1.125V$, SNR = 69dB with $V_{SENSE} = 0.7V$

1750f

APPLICATIONS INFORMATION

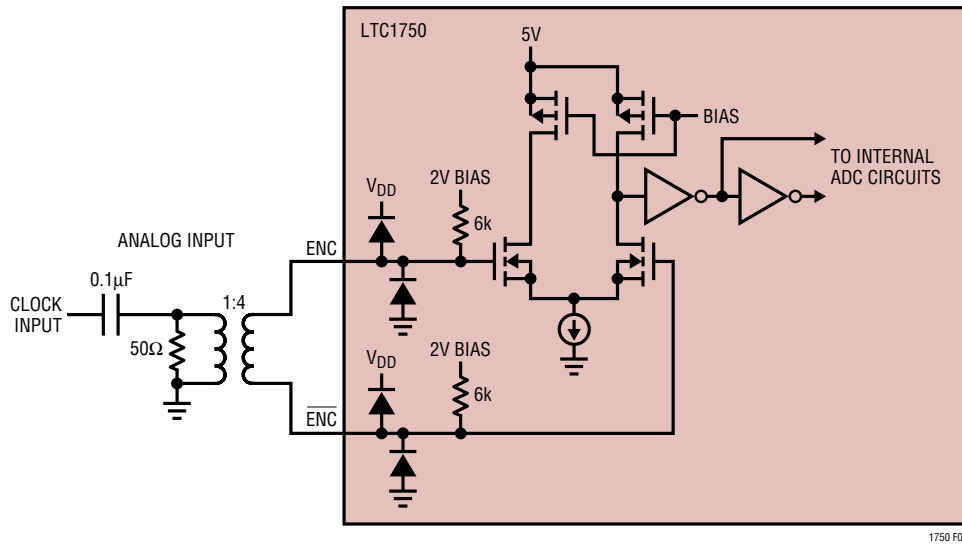

Figure 7. Transformer Driven ENC/ENC

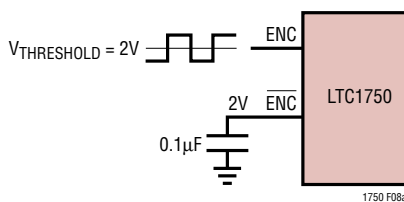

Figure 8a. Single-Ended ENC Drive, Not Recommended for Low Jitter

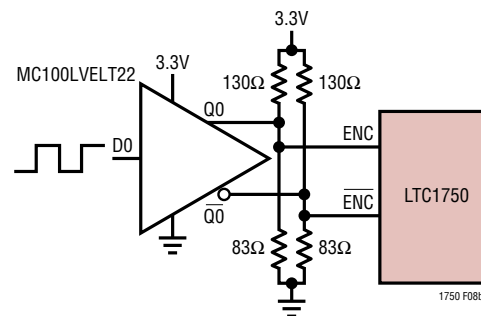

Figure 8b. ENC Drive Using a CMOS-to-PECL Translator

Maximum and Minimum Encode Rates

The maximum encode rate for the LTC1750 is 80MSPs. For the ADC to operate properly the encode signal should have a 50% ($\pm 4\%$) duty cycle. Each half cycle must have at least 6ns for the ADC internal circuitry to have sufficient settling time for proper operation. Achieving a precise 50% duty cycle is easy with differential sinusoidal drive using a transformer or using symmetric differential logic such as PECL or LVDS. When using a single-ended encode signal asymmetric rise and fall times can result in duty cycles that are far from 50%.

At sample rates slower than 80MSPs the duty cycle can vary from 50% as long as each half cycle is at least 6ns.

The lower limit of the LTC1750 sample rate is determined by droop of the sample-and-hold circuits. The pipelined architecture of this ADC relies on storing analog signals on

small valued capacitors. Junction leakage will discharge the capacitors. The specified minimum operating frequency for the LTC1750 is 1MSPs.

DIGITAL OUTPUTS

Digital Output Buffers

Figure 9 shows an equivalent circuit for a single output buffer. Each buffer is powered by $0V_{DD}$ and $0GND$, isolated from the ADC power and ground. The additional N-channel transistor in the output driver allows operation down to low voltages. The internal resistor in series with the output makes the output appear as 50Ω to external circuitry and may eliminate the need for external damping resistors.

APPLICATIONS INFORMATION

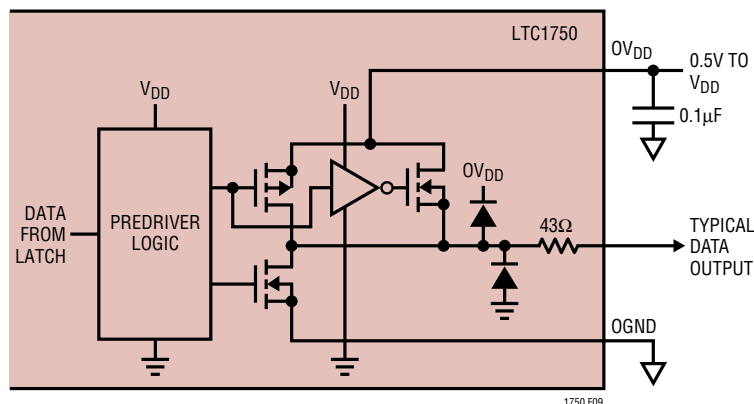

Figure 9. Equivalent Circuit for a Digital Output Buffer

Output Loading

As with all high speed/high resolution converters the digital output loading can affect the performance. The digital outputs of the LTC1750 should drive a minimal capacitive load to avoid possible interaction between the digital outputs and sensitive input circuitry. The output should be buffered with a device such as an ALVCH16373 CMOS latch. For full speed operation the capacitive load should be kept under 10pF. A resistor in series with the output may be used but is not required since the ADC has a series resistor of 43Ω on chip.

Lower OV_{DD} voltages will also help reduce interference from the digital outputs.

Format

The LTC1750 parallel digital output can be selected for offset binary or 2's complement format. The format is selected with the $MSBINV$ pin; high selects offset binary.

Overflow Bit

An overflow output bit indicates when the converter is overranged or underranged. When OF outputs a logic high the converter is either overranged or underranged.

Output Clock

The ADC has a delayed version of the \overline{ENC} input available as a digital output, CLKOUT. The CLKOUT pin can be used to synchronize the converter data to the digital system. This is necessary when using a sinusoidal encode signal.

Data will be updated just after CLKOUT falls and can be latched on the rising edge of CLKOUT.

Output Driver Power

Separate output power and ground pins allow the output drivers to be isolated from the analog circuitry. The power supply for the digital output buffers, OV_{DD} , should be tied to the same power supply as for the logic being driven. For example if the converter is driving a DSP powered by a 3V supply then OV_{DD} should be tied to that same 3V supply. OV_{DD} can be powered with any voltage up to 5V. The logic outputs will swing between OGND and OV_{DD} .

GROUNDING AND BYPASSING

The LTC1750 requires a printed circuit board with a clean unbroken ground plane. A multilayer board with an internal ground plane is recommended. The pinout of the LTC1750 has been optimized for a flowthrough layout so that the interaction between inputs and digital outputs is minimized. Layout for the printed circuit board should ensure that digital and analog signal lines are separated as much as possible. In particular, care should be taken not to run any digital track alongside an analog signal track or underneath the ADC.

High quality ceramic bypass capacitors should be used at the V_{DD} , V_{CM} , REFHA, REFHB, REFLA and REFLB pins as shown in the block diagram on the front page of this data sheet. Bypass capacitors must be located as close to the pins as possible. Of particular importance are the capacitors between REFHA and REFLB and between REFHB and

APPLICATIONS INFORMATION

REFLA. These capacitors should be as close to the device as possible (1.5mm or less). Size 0402 ceramic capacitors are recommended. The large 4.7 μ F capacitor between REFHA and REFLA can be somewhat further away. The traces connecting the pins and bypass capacitors must be kept short and should be made as wide as possible.

The LTC1750 differential inputs should run parallel and close to each other. The input traces should be as short as possible to minimize capacitance and to minimize noise pickup.

An analog ground plane separate from the digital processing system ground should be used. All ADC ground pins labeled GND should connect to this plane. All ADC V_{DD} bypass capacitors, reference bypass capacitors and input filter capacitors should connect to this analog plane. The LTC1750 has three output driver ground pins, labeled OGND (Pins 27, 38 and 47). These grounds should connect to the digital processing system ground. The output driver supply, OV_{DD} should be connected to the digital

processing system supply. OV_{DD} bypass capacitors should bypass to the digital system ground. The digital processing system ground should be connected to the analog plane at ADC OGND (Pin 38).

HEAT TRANSFER

Most of the heat generated by the LTC1750 is transferred from the die through the package leads onto the printed circuit board. In particular, ground pins 12, 13, 36 and 37 are fused to the die attach pad. These pins have the lowest thermal resistance between the die and the outside environment. It is critical that all ground pins are connected to a ground plane of sufficient area. The layout of the evaluation circuit shown on the following pages has a low thermal resistance path to the internal ground plane by using multiple vias near the ground pins. A ground plane of this size results in a thermal resistance from the die to ambient of 35°C/W. Smaller area ground planes or poorly connected ground pins will result in higher thermal resistance.

PACKAGE DESCRIPTION

FW Package 48-Lead Plastic TSSOP (6.1mm) (Reference LTC DWG # 05-08-1651)

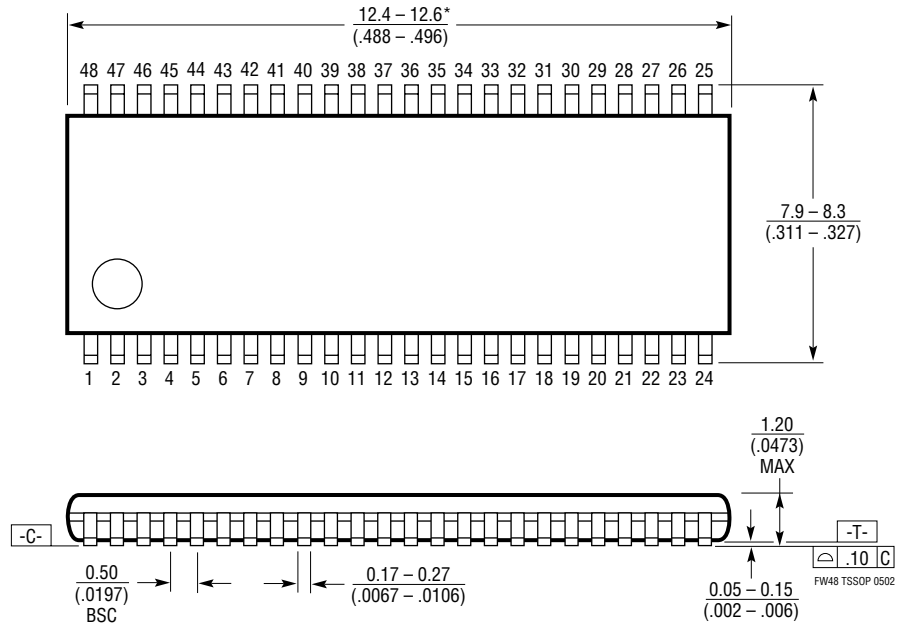
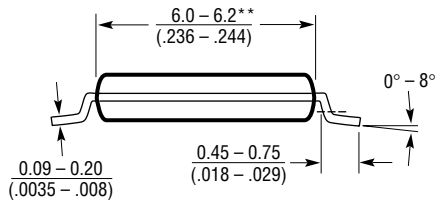
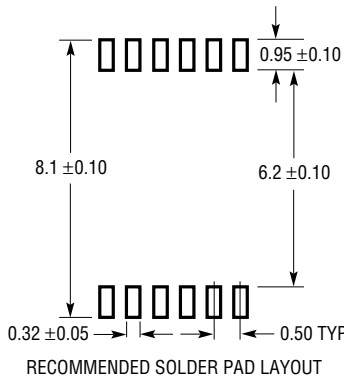

NOTE:

1. CONTROLLING DIMENSION: MILLIMETERS
2. DIMENSIONS ARE IN $\frac{\text{MILLIMETERS}}{\text{(INCHES)}}$

3. DRAWING NOT TO SCALE

- *DIMENSIONS DO NOT INCLUDE MOLD FLASH. MOLD FLASH SHALL NOT EXCEED .152mm (.006") PER SIDE
- **DIMENSIONS DO NOT INCLUDE INTERLEAD FLASH. INTERLEAD FLASH SHALL NOT EXCEED .254mm (.010") PER SIDE

RELATED PARTS

PART NUMBER	DESCRIPTION	COMMENTS
LTC1405	12-Bit, 5Msps Sampling ADC with Parallel Output	Pin Compatible with the LTC1420
LTC1406	8-Bit, 20Msps ADC	Undersampling Capability up to 70MHz
LTC1411	14-Bit, 2.5Msps ADC	5V, No Pipeline Delay, 80dB SINAD
LTC1412	12-Bit, 3Msps, Sampling ADC	$\pm 5V$, No Pipeline Delay, 72dB SINAD
LTC1414	14-Bit, 2.2Msps ADC	$\pm 5V$, 81dB SINAD and 95dB SFDR
LTC1420	12-Bit, 10Msps ADC	71dB SINAD and 83dB SFDR at Nyquist
LT [®] 1461	Micropower Precision Series Reference	0.04% Max Initial Accuracy, 3ppm/°C Drift
LTC1666	12-Bit, 50Msps DAC	Pin Compatible with the LTC1668, LTC1667
LTC1667	14-Bit, 50Msps DAC	Pin Compatible with the LTC1668, LTC1666
LTC1668	16-Bit, 50Msps DAC	16-Bit Monotonic, 87dB SFDR, 5pV-s Glitch Impulse
LTC1741	12-Bit, 65Msps ADC	Pin Compatible with the LTC1743, LTC1745, LTC1747
LTC1742	14-Bit, 65Msps ADC	Pin Compatible with the LTC1744, LTC1746, LTC1748
LTC1743	12-Bit, 50Msps ADC	Pin Compatible with the LTC1741, LTC1745, LTC1747
LTC1744	14-Bit, 50Msps ADC	Pin Compatible with the LTC1742, LTC1746, LTC1748
LTC1745	12-Bit, 25Msps ADC	Pin Compatible with the LTC1741, LTC1743, LTC1747
LTC1746	14-Bit, 25Msps ADC	Pin Compatible with the LTC1742, LTC1744, LTC1748
LTC1747	12-Bit, 80Msps ADC	Pin Compatible with the LTC1741, LTC1743, LTC1745
LTC1748	14-Bit, 80Msps ADC	Pin Compatible with the LTC1742, LTC1744, LTC1746
LTC1749	12-Bit, 80Msps ADC with Wide Bandwidth	Pin Compatible with the LTC1750
LT1807	325MHz, Low Distortion Dual Op Amp	Rail-to-Rail Input and Output
LT5512	High Signal Level Down Converting Mixer	DC to 3GHz, 17dBm IIP3, Integrated LO Buffer
LT5515	Direct Conversion Demodulator	1.5GHz to 2.5GHz, 21.5dBm IIP3, Integrated LO Quadrature Generator
LT5516	Direct Conversion Quadrature Demodulator	800MHz to 3GHz, 17dBm IIP3, Integrated LO Buffer
LT5522	High Signal Level Down Converting Mixer	600MHz to 3GHz, 25dBm IIP3, Integrated LO Buffer





Looking for pricing, stock, or lifecycle information?

Click below to explore more details on WIN SOURCE:

 [View LTC1750CFW#TRPBF on WIN SOURCE](#)

 [Linear Technology](#) Information

Optimize Your Supply Chain with WIN SOURCE Solutions

-  Global Sourcing Solution
-  Obsolete Management
-  Cost Control Management
-  Shortage Management
-  Alternative Solution
-  Excess Inventory Management