



**THE DATASHEET OF
LTC3250ES6-1.5#TRPBF**



High Efficiency, Low Noise, Inductorless Step-Down DC/DC Converter

FEATURES

- 2.7V to 5.5V Input Voltage Range
- No Inductors
- Li-Ion (3.6V) to 1.5V with 81% Efficiency
- Low Noise Constant Frequency Operation
- Output Voltages: 1.5V \pm 4%, 1.2V \pm 4%
- Output Current: 250mA
- Shutdown Disconnects Load from V_{IN}
- Low Operating Current: $I_Q = 35\mu A$
- Low Shutdown Current: $I_{SD} < 1\mu A$
- Oscillator Frequency = 1.5MHz
- Soft-Start Limits Inrush Current at Turn-On
- Short-Circuit and Overtemperature Protected
- Low Profile (1mm) SOT-23 Package

APPLICATIONS

- Handheld Computers
- Cellular Phones
- Digital Cameras
- Handheld Medical Instruments
- Low Power DSP Supplies

DESCRIPTION

The LTC[®]3250-1.5/LTC3250-1.2 are charge pump step-down DC/DC converters that produce a 1.5V or 1.2V regulated output from a 2.7V to 5.5V input. The parts use switched capacitor fractional conversion to achieve typical efficiency two times higher than that of a linear regulator. No inductors are required.

A unique constant frequency architecture provides a low noise regulated output as well as lower input noise than conventional charge pump regulators.* High frequency operation ($f_{OSC} = 1.5MHz$) simplifies filtering to further reduce conducted noise. The part also uses Burst Mode[®] operation to improve efficiency at light loads.

Low operating current (35 μA with no load, <1 μA in shutdown) and low external parts count (three small ceramic capacitors) make the LTC3250-1.5/LTC3250-1.2 ideally suited for space constrained battery powered applications. The parts are short-circuit and overtemperature protected, and are available in a low profile (1mm) 6-pin ThinSOT[™] package.

LT, LTC and LT are registered trademarks of Linear Technology Corporation
 Burst Mode is a registered trademark of Linear Technology Corporation
 ThinSOT is a trademark of Linear Technology Corporation.
 *U.S. Patent #6, 411, 531

TYPICAL APPLICATION

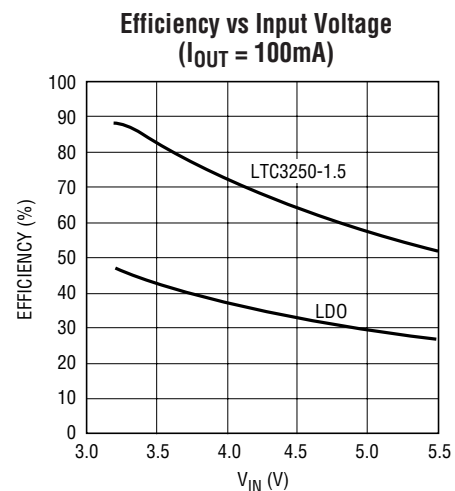
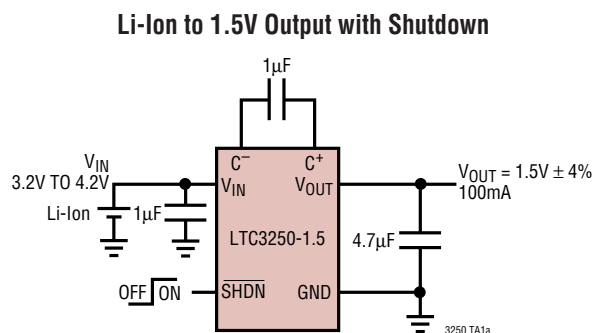

3250 TA01b

3250fa

LTC3250-1.5/LTC3250-1.2

ABSOLUTE MAXIMUM RATINGS

(Note 1)

V_{IN} to GND	-0.3V to 6V
\overline{SHDN} to GND	-0.3V to ($V_{IN} + 0.3V$)
I_{OUT} (Note 2)	350mA
Operating Ambient Temperature Range (Note 3)	-40°C to 85°C
Storage Temperature Range	-65°C to 150°C
Lead Temperature (Soldering, 10 sec)	300°C

PACKAGE/ORDER INFORMATION

	ORDER PART NUMBER
	LTC3250ES6-1.5 LTC3250ES6-1.2
	S6 PART MARKING
	LTZE LTAGJ

Consult LTC Marketing for parts specified with wider operating temperature ranges.

ELECTRICAL CHARACTERISTICS

The ● denotes the specifications which apply over the full operating temperature range, otherwise specifications are at $T_A = 25^\circ\text{C}$. $V_{IN} = 3.6V$, $C_{FLY} = 1\mu\text{F}$, $C_{IN} = 1\mu\text{F}$, $C_{OUT} = 4.7\mu\text{F}$ unless otherwise noted.

SYMBOL	PARAMETER	CONDITIONS	MIN	TYP	MAX	UNITS	
V_{IN}	LTC3250-1.5 Operating Voltage Range		●	3.1	5.5	V	
	LTC3250-1.2 Operating Voltage Range		●	2.7	5.5	V	
V_{OUT}	LTC3250-1.5 Output Voltage Range	$I_{OUT} \leq 50\text{mA}$ $3.1V \leq V_{IN} \leq 5.5V$	●	1.44	1.5	1.56	V
		$I_{OUT} \leq 100\text{mA}$ $3.2V \leq V_{IN} \leq 5.5V$	●	1.44	1.5	1.56	V
		$I_{OUT} \leq 250\text{mA}$ $3.5V \leq V_{IN} \leq 5V$		1.44	1.5	1.56	V
	LTC3250-1.2 Output Voltage Range	$I_{OUT} \leq 150\text{mA}$ $2.7V < V_{IN} < 5.5V$	●	1.15	1.2	1.25	V
		$I_{OUT} \leq 250\text{mA}$ $2.9V \leq V_{IN} \leq 5V$		1.15	1.2	1.25	V
I_{IN}	Operating Current	$I_{OUT} = 0\text{mA}$	●		35	60	μA
	Shutdown Current	$\overline{SHDN} = 0V$	●		0.01	1	μA
V_{RB}	Burst Mode Operation Output Ripple				12	mV _{p-p}	
V_{RC}	Continuous Mode Output Ripple				4	mV _{p-p}	
f_{OSC}	Switching Frequency		●	1.2	1.5	1.8	MHz
V_{IH}	\overline{SHDN} Input Hi Voltage		●	1.2	0.8		V
V_{IL}	\overline{SHDN} Input Low Voltage		●		0.8	0.4	V
I_{IH}	\overline{SHDN} Input Current	$\overline{SHDN} = V_{IN}$	●	-1		1	μA
I_{IL}	\overline{SHDN} Input Current	$\overline{SHDN} = 0V$	●	-1		1	μA
t_{ON}	Turn On Time	$R_{LOAD} = 6\Omega$			0.8		ms
	LTC3250-1.5 Load Regulation	$0 \leq I_{OUT} \leq 250\text{mA}$			0.15		mV/mA
	LTC3250-1.2 Load Regulation	$0 \leq I_{OUT} \leq 250\text{mA}$			0.12		mV/mA
	Line Regulation	$I_{OUT} = 250\text{mA}$			0.2		%/V
R_{OL}	Open-Loop Output Impedance	$I_{OUT} = 250\text{mA}$ (Note 4)			1.0		Ω

Note 1: Absolute Maximum Ratings are those values beyond which the life of a device may be impaired.

Note 2: Based on long term current density limitations.

Note 3: The LTC3250-1.5E/LTC3250-1.2E are guaranteed to meet specified performance from 0°C to 70°C. Specifications over the -40°C and 85°C operating temperature range are assured by design characterization and correlation with statistical process controls.

Note 4: Output not in regulation; $R_{OL} = (V_{IN}/2 - V_{OUT})/I_{OUT}$.

Note 5: This IC includes overtemperature protection that is intended to protect the device during momentary overload conditions. Junction temperature will exceed 125°C when overtemperature protection is active. Continuous operation above the specified maximum operating junction temperature may impair device reliability.

TYPICAL PERFORMANCE CHARACTERISTICS

No Load Supply Current vs Supply Voltage

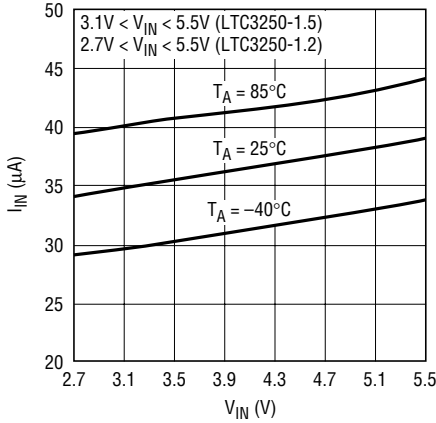

3250 G01

Oscillator Frequency vs Supply Voltage

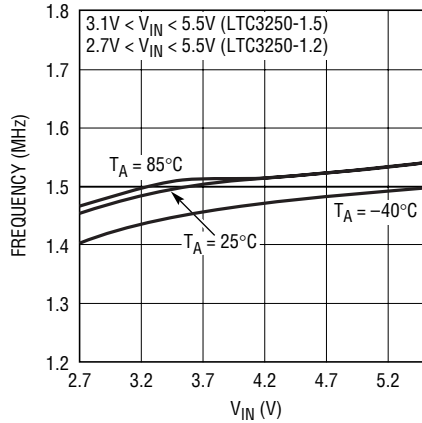

3250 G02

V_{SHDN} Threshold Voltage vs Supply Voltage

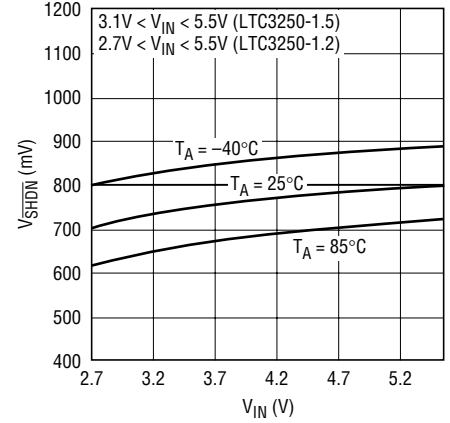

3250 G03

(LTC3250-1.5)

Output Voltage vs Load Current

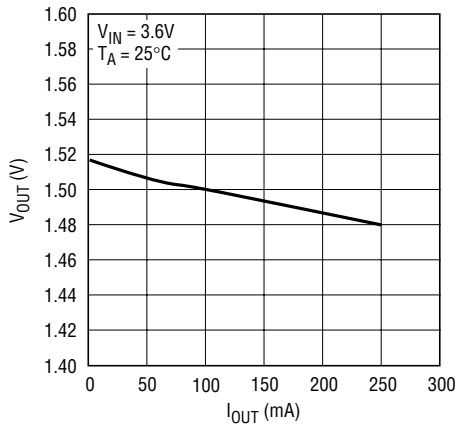

3250 G04

Efficiency vs Output Current

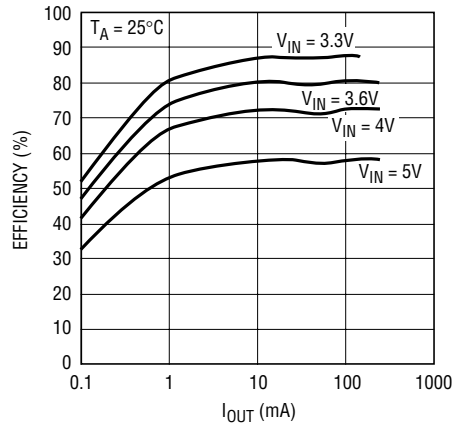

3250 G05

Output Voltage vs Supply Voltage

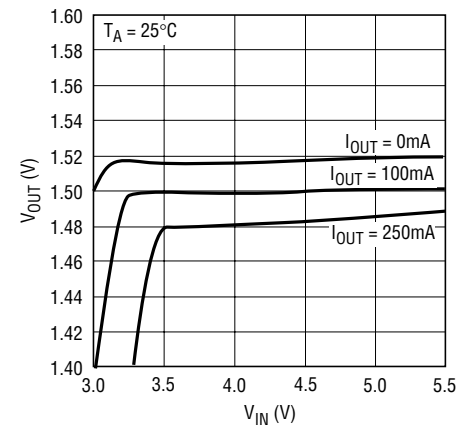

3250 G06

(LTC3250-1.2)

Output Voltage vs Load Current

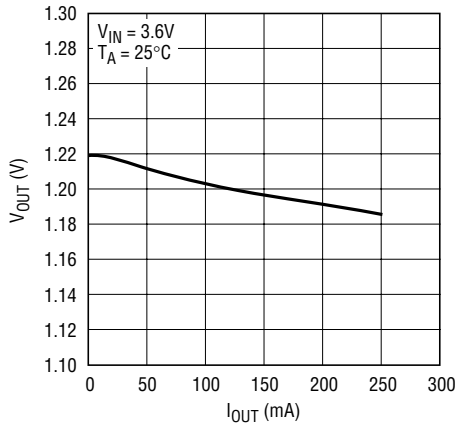

3250 G12

Efficiency vs Output Current

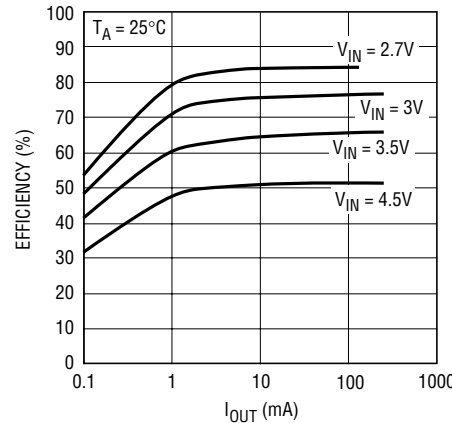

3250 G13

Output Voltage vs Supply Voltage

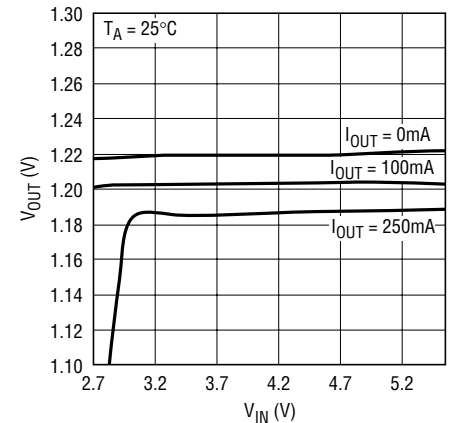

3250 G14

3250fa

TYPICAL PERFORMANCE CHARACTERISTICS

Output Voltage Soft-Start and Shutdown (LTC3250-1.5)

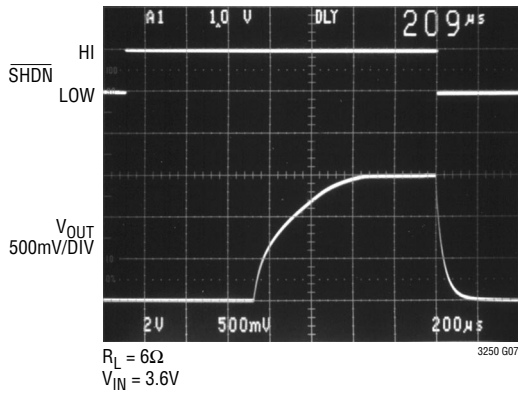

Output Current Transient Response (LTC3250-1.5)

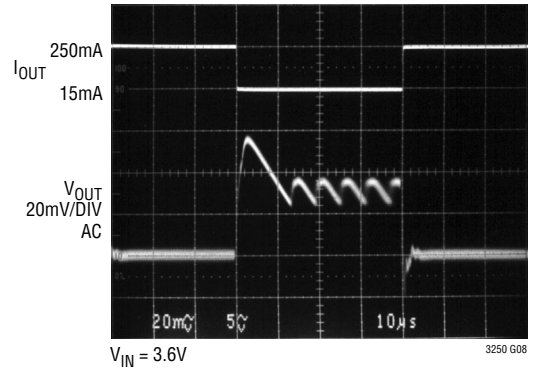

Line Transient Response (LTC3250-1.5)

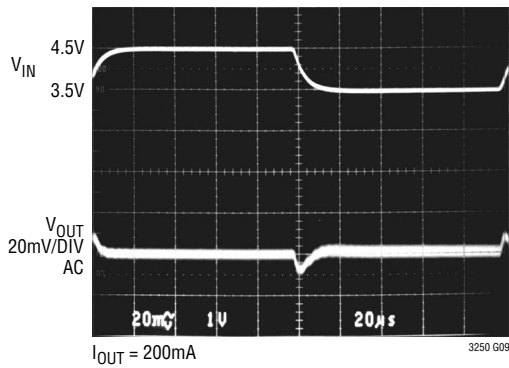

Input Voltage Ripple vs Input Capacitor (LTC3250-1.5)

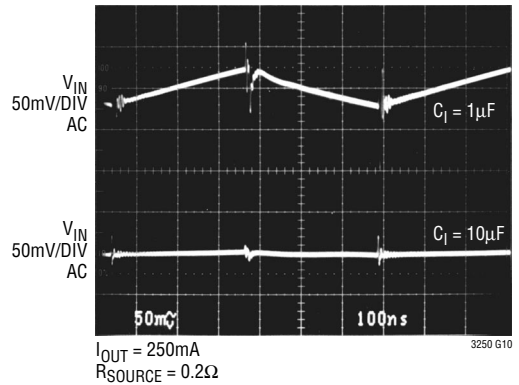

Output Voltage Ripple (LTC3250-1.5)

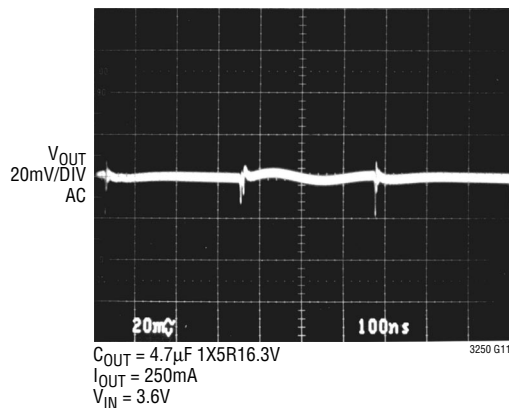

PIN FUNCTIONS

V_{IN} (Pin 1): Input Supply Voltage. Bypass V_{IN} with a $\geq 1\mu\text{F}$ low ESR ceramic capacitor.

GND (Pin 2): Ground. Connect to a ground plane for best performance.

SHDN (Pin 3): Active Low Shutdown Input. A low voltage on SHDN disables the LTC3250-1.5/LTC3250-1.2. SHDN must not be allowed to float.

C⁻ (Pin 4): Flying Capacitor Negative Terminal

V_{OUT} (Pin 5): Regulated Output Voltage. V_{OUT} is disconnected from V_{IN} during shutdown. Bypass V_{OUT} with a $\geq 4.7\mu\text{F}$ low ESR ceramic capacitor ($2.5\mu\text{F}$ min, ESR $< 100\text{m}\Omega$).

C⁺ (Pin 6): Flying Capacitor Positive Terminal.

BLOCK DIAGRAM

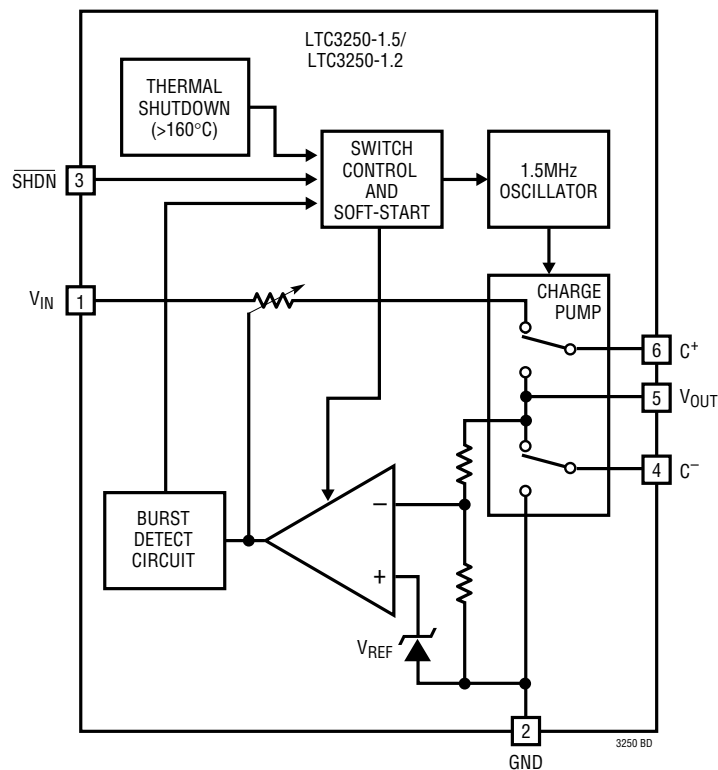

OPERATION (Refer to Simplified Block Diagram)

The LTC3250-1.5/LTC3250-1.2 use a switched capacitor charge pump to step down V_{IN} to a regulated $1.5V \pm 4\%$ or $1.2V \pm 4\%$ (respectively) output voltage. Regulation is achieved by sensing the output voltage through an internal resistor divider and modulating the charge pump output current based on the error signal. A 2-phase nonoverlapping clock activates the charge pump switches. On the first phase of the clock current is transferred from V_{IN} , through the flying capacitor, to V_{OUT} . Not only is current being delivered to V_{OUT} on the first phase, but the flying capacitor is also being charged up. On the second phase of the clock the flying capacitor is connected from V_{OUT} to ground, delivering the charge stored during the first phase of the clock to V_{OUT} . Using this method of switching, only half of the output current is delivered from V_{IN} , thus achieving twice the efficiency over a conventional LDO. The sequence of charging and dis-charging the flying capacitor continues at a free running frequency of 1.5MHz (typ). This constant frequency architecture provides a low noise regulated output as well as lower input noise than conventional switch-capacitor charge pump regulators. The part also has a low current Burst Mode operation to improve efficiency even at light loads.

In shutdown mode all circuitry is turned off and the LTC3250-1.5/LTC3250-1.2 draw only leakage current from the V_{IN} supply. Furthermore, V_{OUT} is disconnected from V_{IN} . The SHDN pin is a CMOS input with a threshold voltage of approximately 0.8V. The LTC3250-1.5/LTC3250-1.2 are in shutdown when a logic low is applied to the SHDN pin. Since the SHDN pin is a high impedance CMOS input it should never be allowed to float. To ensure that its state is defined it must always be driven with a valid logic level.

Short-Circuit/Thermal Protection

The LTC3250-1.5/LTC3250-1.2 have built-in short-circuit current limiting as well as overtemperature protection. During short-circuit conditions, the parts will automatically limit the output current to approximately 500mA. At higher temperatures, or if the input voltage is high enough to cause excessive self heating on chip, thermal shutdown circuitry will shut down the charge pump once the junction

temperature exceeds approximately 160°C . It will reenables the charge pump once the junction temperature drops back to approximately 150°C . The LTC3250-1.5/LTC3250-1.2 will cycle in and out of thermal shutdown without latch-up or damage until the short-circuit on V_{OUT} is removed. Long term overstress ($I_{OUT} > 350\text{mA}$, and/or $T_J > 140^{\circ}\text{C}$) should be avoided as it can degrade the performance of the part.

Soft-Start

To prevent excessive current flow at V_{IN} during start-up, the LTC3250-1.5/LTC3250-1.2 have a built-in soft-start circuitry. Soft-start is achieved by increasing the amount of current available to the output charge storage capacitor linearly over a period of approximately $500\mu\text{s}$. Soft-start is enabled whenever the device is brought out of shutdown, and is disabled shortly after regulation is achieved.

Low Current “Burst Mode” Operation

To improve efficiency at low output currents, Burst Mode operation was included in the design of the LTC3250-1.5/LTC3250-1.2. An output current sense is used to detect when the required output current drops below an internally set threshold (30mA typ.). When this occurs, the part shuts down the internal oscillator and goes into a low current operating state. The LTC3250-1.5/LTC3250-1.2 will remain in the low current operating state until the output has dropped enough to require another burst of current. Unlike traditional charge pumps whose burst current is dependant on many factors (i.e. supply voltage, switch resistance, capacitor selection, etc.), the LTC3250-1.5/LTC3250-1.2's burst current is set by the burst threshold and hysteresis. This means that the V_{OUT} ripple voltage in Burst Mode will be fixed and is typically 12mV for a $4.7\mu\text{F}$ output capacitor.

Power Efficiency

The power efficiency (η) of the LTC3250-1.5/LTC3250-1.2 are approximately double that of a conventional linear regulator. This occurs because the input current for a 2 to 1 step-down charge pump is approximately half the output

OPERATION (Refer to Simplified Block Diagram)

current. For an ideal 2 to 1 step-down charge pump the power efficiency is given by:

$$\eta \equiv \frac{P_{OUT}}{P_{IN}} = \frac{V_{OUT} \cdot I_{OUT}}{V_{IN} \cdot \frac{1}{2} I_{OUT}} = \frac{2V_{OUT}}{V_{IN}}$$

The switching losses and quiescent current of the LTC3250-1.5/LTC3250-1.2 are designed to minimize efficiency loss over the entire output current range, causing only a couple % error from the theoretical efficiency. For example with $V_{IN} = 3.6V$, $I_{OUT} = 100mA$ and V_{OUT} regulating to 1.5V the measured efficiency is 80.6% which is in close agreement with the theoretical 83.3% calculation.

V_{OUT} Capacitor Selection

The ESR and value of capacitors used with the LTC3250-1.5/LTC3250-1.2 determine several important parameters such as regulator control loop stability, output ripple, and charge pump strength.

The value of C_{OUT} directly controls the amount of output ripple for a given load current. Increasing the size of C_{OUT} will reduce the output ripple.

To reduce output noise and ripple, it is suggested that a low ESR ($<0.1\Omega$) ceramic capacitor (4.7 μF or greater) be used for C_{OUT} . Tantalum and aluminum capacitors are not recommended because of their high ESR.

Both ESR and value of the C_{OUT} can significantly affect the stability of the LTC3250-1.5/LTC3250-1.2. As shown in the block diagram, the LTC3250-1.5/LTC3250-1.2 use a control loop to adjust the strength of the charge pump to match the current required at the output. The error signal of this loop is stored directly on the output charge storage capacitor. Thus the charge storage capacitor also serves to form the dominant pole for the control loop. To prevent ringing or instability it is important for the output capacitor to maintain at least 2.5 μF of capacitance over all conditions (see “Ceramic Capacitor Selection Guidelines” section).

Likewise excessive ESR on the output capacitor will tend to degrade the loop stability of the LTC3250-1.5/LTC3250-1.2. The closed-loop output resistance is designed to be

0.15 Ω for the LTC3250-1.5 and 0.12 Ω for the LTC3250-1.2. For a 250mA load current change the output voltage will change by about 37mV for the LTC3250-1.5 and by 30mV for the LTC 3250-1.2. If the ESR of the output capacitor is greater than the closed-loop-output impedance the part will cease to roll-off in a simple one-pole fashion and poor load transient response or instability could result. Ceramic capacitors typically have exceptional ESR performance and combined with a tight board layout should yield excellent stability and load transient performance.

Further output noise reduction can be achieved by filtering the LTC3250-1.5/LTC3250-1.2 output through a very small series inductor as shown in Figure 1. A 10nH inductor will

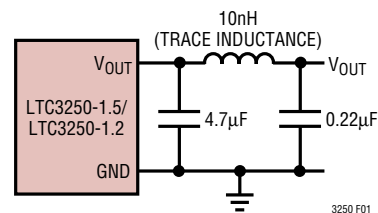

Figure 1. 10nH Inductor Used for Additional Output Noise Reduction

reject the fast output transients, thereby presenting a nearly constant output voltage. For economy the 10nH inductor can be fabricated on the PC board with about 1cm (0.4") of PC board trace.

V_{IN} Capacitor Selection

The constant frequency architecture used by the LTC3250-1.5/LTC3250-1.2 makes input noise filtering much less demanding than conventional charge pump regulators. On a cycle by cycle basis, the LTC3250-1.5/LTC3250-1.2 input current will go from $I_{OUT}/2$ to 0mA. Lower ESR will reduce the voltage steps caused by changing input current, while the absolute capacitor value will determine the level of ripple. For optimal input noise and ripple reduction, it is recommended that a low ESR 1 μF or greater ceramic capacitor be used for C_{IN} (see “Ceramic Capacitor Selection Guidelines” section). Aluminum and tantalum capacitors are not recommended because of their high ESR.

OPERATION (Refer to Simplified Block Diagram)

Flying Capacitor Selection

Warning: A polarized capacitor such as tantalum or aluminum should never be used for the flying capacitor since its voltage can reverse upon start-up of the LTC3250-1.5/LTC3250-1.2. Ceramic capacitors should always be used for the flying capacitor.

The flying capacitor controls the strength of the charge pump. In order to achieve the rated output current it is necessary for the flying capacitor to have at least $0.4\mu\text{F}$ of capacitance over operating temperature with a 2V bias (see “Ceramic Capacitor Selection Guidelines” section). If only 100mA or less of output current is required for the application the flying capacitor minimum can be reduced to $0.15\mu\text{F}$.

Ceramic Capacitor Selection Guidelines

Capacitors of different materials lose their capacitance with higher temperature and voltage at different rates. For example, a ceramic capacitor made of X7R material will retain most of its capacitance from -40°C to 85°C whereas a Z5U or Y5V style capacitor will lose considerable capacitance over that range (60% to 80% loss typ.). Z5U and Y5V capacitors may also have a very strong voltage coefficient causing them to lose an additional 60% or more of their capacitance when the rated voltage is applied. Therefore, when comparing different capacitors it is often more appropriate to compare the amount of achievable capacitance for a given case size rather than discussing the specified capacitance value. For example, over rated voltage and temperature conditions, a $4.7\mu\text{F}$, 10V, Y5V ceramic capacitor in a 0805 case may not provide any more capacitance than a $1\mu\text{F}$, 10V, X7R available in the same 0805 case. In fact over bias and temperature range, the $1\mu\text{F}$, 10V, X7R will provide more capacitance than the $4.7\mu\text{F}$, 10V, Y5V. The capacitor manufacturer’s data sheet should be consulted to determine what value of capacitor is needed to ensure minimum capacitance values are met over operating temperature and bias voltage.

Below is a list of ceramic capacitor manufacturers and how to contact them:

AVX	1-(803)-448-1943	www.avxcorp.com
Kemet	1-(864)-963-6300	www.kemet.com
Murata	1-(800)-831-9172	www.murata.com
Taiyo Yuden	1-(800)-348-2496	www.t-yuden.com
Vishay	1-(800)-487-9437	www.vishay.com

Layout Considerations

Due to the high switching frequency and transient currents produced by the LTC3250-1.5/LTC3250-1.2 careful board layout is necessary for optimal performance. A true ground plane and short connections to all capacitors will improve performance and ensure proper regulation under all conditions. Figure 2 shows the recommended layout configuration.

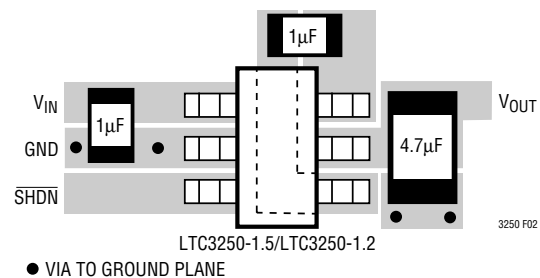

Figure 2. Recommended Layout

The flying capacitor pins, C^+ and C^- will have very high edge rate wave forms. The large dv/dt on these pins can couple energy capacitively to adjacent printed circuit board runs. Magnetic fields can also be generated if the flying capacitors are not close to the LTC3250-1.5/LTC3250-1.2 (i.e. the loop area is large). To decouple capacitive energy transfer, a Faraday shield may be used. This is a grounded PC trace between the sensitive node and the LTC3250-1.5/LTC3250-1.2 pins. For a high quality AC ground it should be returned to a solid ground plane that extends all the way to the LTC3250-1.5/LTC3250-1.2.

OPERATION (Refer to Simplified Block Diagram)

Thermal Management

For higher input voltages and maximum output current there can be substantial power dissipation in the LTC3250-1.5/LTC3250-1.2. If the junction temperature increases above approximately 160°C the thermal shutdown circuitry will automatically deactivate the output. To reduce the maximum junction temperature, a good thermal connection to the PC board is recommended. Connecting the GND pin (Pin 2) to a ground plane, and maintaining a solid ground plane under the device can reduce the thermal resistance of the package and PC board considerably.

Derating Power at Higher Temperatures

To prevent an overtemperature condition in high power applications Figure 3 should be used to determine the maximum combination of ambient temperature and power

dissipation. The power dissipated in the LTC3250-1.5/LTC3250-1.2 should always fall under the line shown (i.e. within the safe region) for a given ambient temperature. The power dissipated in the LTC3250-1.5/LTC3250-1.2 is given by the expression:

$$P_D = \left(\frac{V_{IN}}{2} - V_{OUT} \right) I_{OUT}$$

This derating curve assumes a maximum thermal resistance, θ_{JA} , of 175°C/W for the 6-pin ThinSOT-23. This thermal resistances can be achieved from a printed circuit board layout with a solid ground plane (2000mm²) on at least one layer with a good thermal connection to the ground pin of the LTC3250-1.5/LTC3250-1.2. Operation outside of this curve will cause the junction temperature to exceed 140°C which may trigger the thermal shutdown circuitry and ultimately reduce the life of the device.

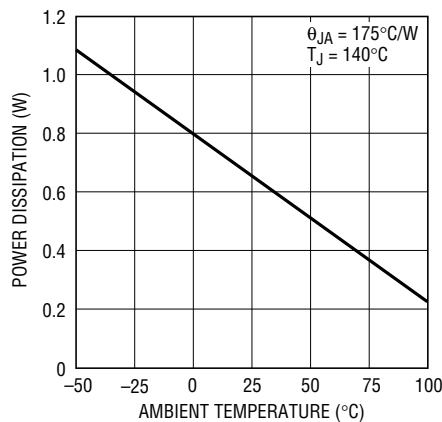

3250 • F03

Figure 3. Maximum Power Dissipation vs Ambient Temperature

TYPICAL APPLICATIONS

Fixed 3.3V Input to 1.5V Output with Shutdown

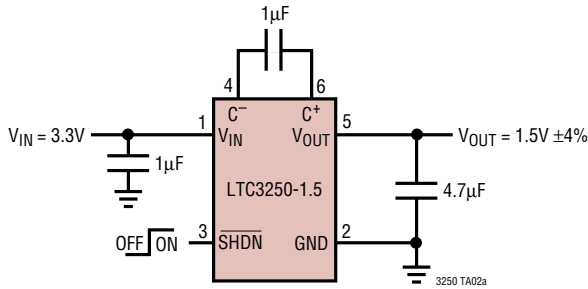

Efficiency vs Output Current

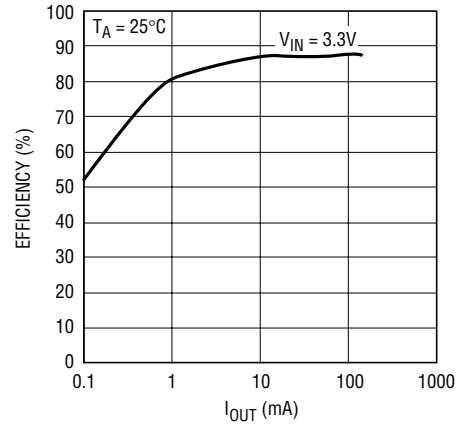

3250 TA02b

Li-Ion or 3-Cell NiMH to 1.5V Output with Shutdown

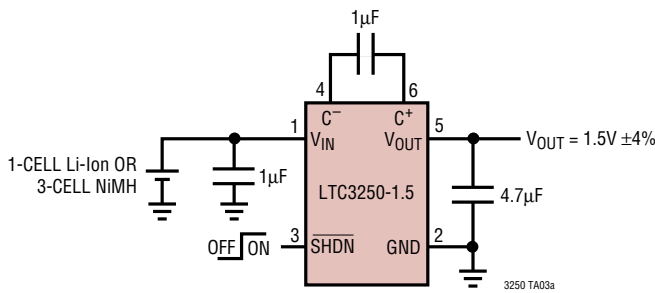

Efficiency vs Output Current

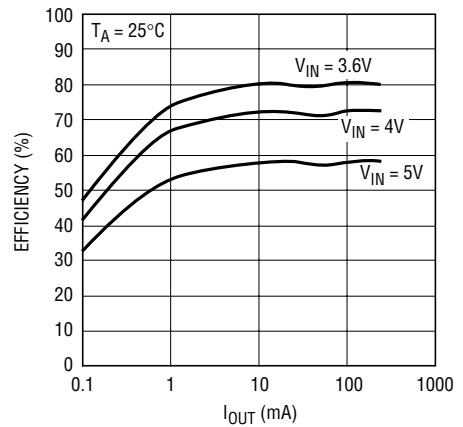

3250 TA03b

3-Cell NiMH to 1.2V Output with Shutdown

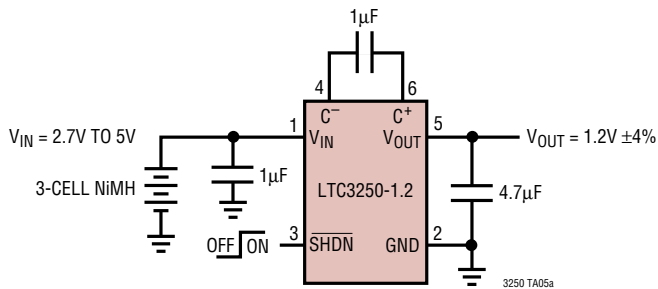

Efficiency vs Input Voltage
(I_{OUT} = 100mA)

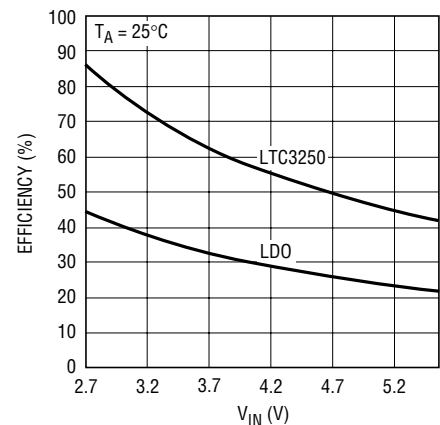

3250 TA05b

PACKAGE DESCRIPTION

S6 Package
6-Lead Plastic TSOT-23
 (Reference LTC DWG # 05-08-1636)

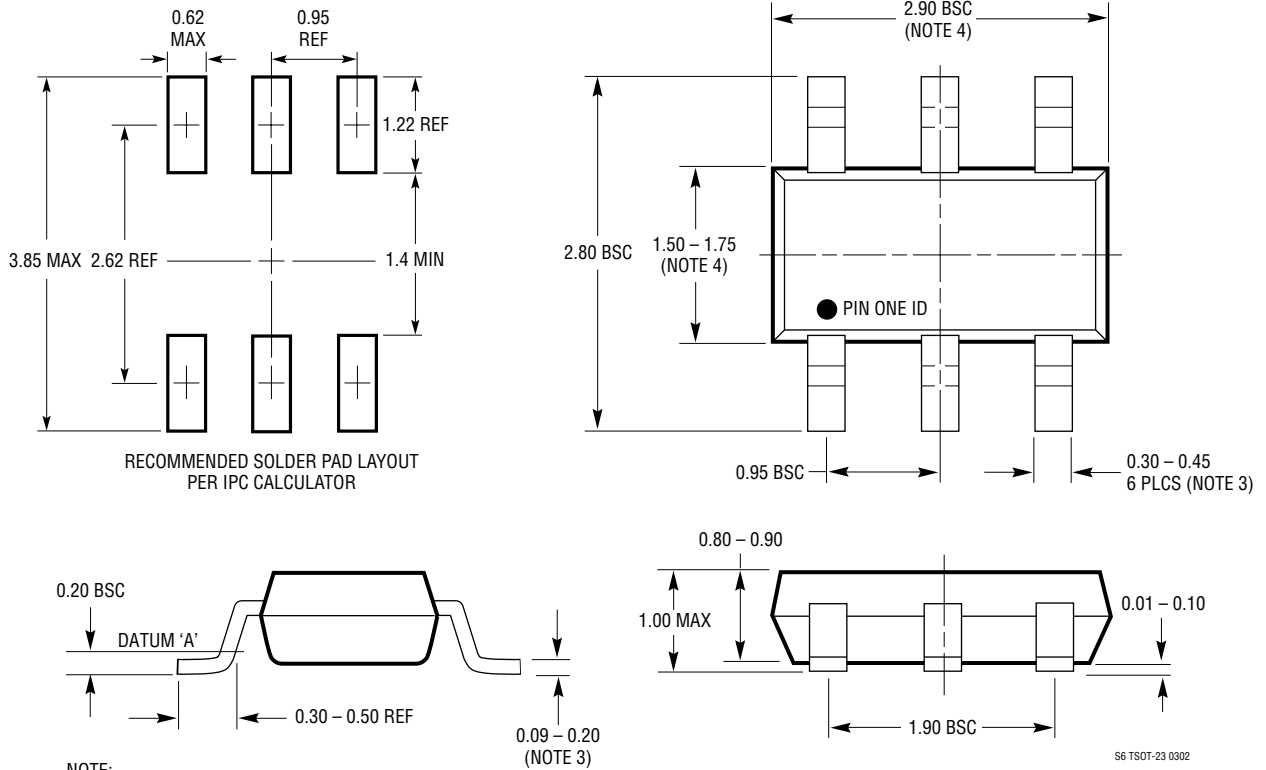

- NOTE:
1. DIMENSIONS ARE IN MILLIMETERS
 2. DRAWING NOT TO SCALE
 3. DIMENSIONS ARE INCLUSIVE OF PLATING
 4. DIMENSIONS ARE EXCLUSIVE OF MOLD FLASH AND METAL BURR
 5. MOLD FLASH SHALL NOT EXCEED 0.254mm
 6. JEDEC PACKAGE REFERENCE IS MO-193

S6 TSOT-23 0302

TYPICAL APPLICATION

Multiple High Efficiency Outputs from Single Li-Ion Battery

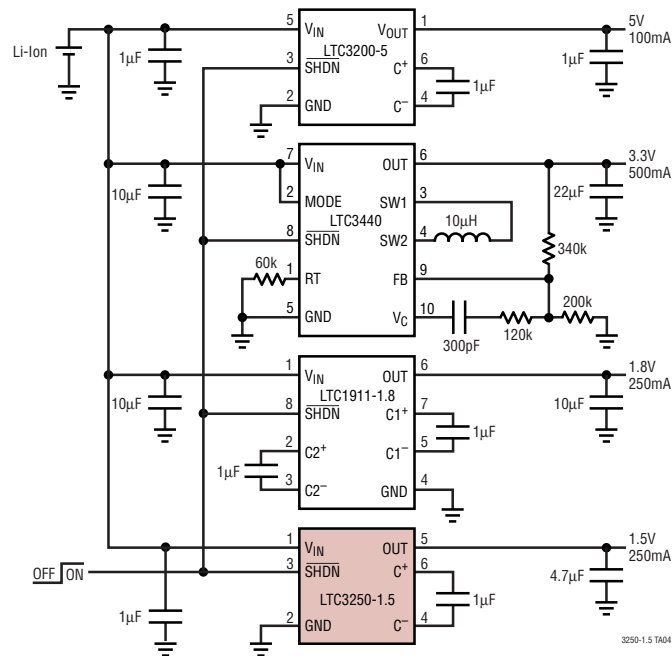



RELATED PARTS

PART NUMBER	DESCRIPTION	COMMENTS
LTC1514	50mA, 650kHz, Step Up/Down Charge Pump with Low Battery Comparator	V_{IN} : 2.7V to 10V, V_{OUT} : 3V/5V, Regulated Output, I_Q : 60 μ A, I_{SD} : 10 μ A, S8 Package
LTC1515	50mA, 650kHz, Step Up/Down Charge Pump with Power On Reset	V_{IN} : 2.7V to 10V, V_{OUT} : 3.3V or 5V, Regulated Output, I_Q : 60 μ A, I_{SD} : <1 μ A, S8 Package
LT1776	500mA (I_{OUT}), 200kHz, High Efficiency Step-Down DC/DC Converter	90% Efficiency, V_{IN} : 7.4V to 40V, $V_{OUT(MIN)}$: 1.24V, I_Q : 3.2mA, I_{SD} : 30 μ A, N8,S8 Packages
LTC1911-1.5/LTC1911-1.8	250mA, 1.5MHz, High Efficiency Step-Down Charge Pump	75% Efficiency, V_{IN} : 2.7V to 5.5V, V_{OUT} : 1.5V/1.8V, Regulated Output, I_Q : 180 μ A, I_{SD} : 10 μ A, MS8 Package
LTC3251	500mA, Spread Spectrum, High Efficiency Step-Down Charge Pump	Up to 90% Efficiency, V_{IN} : 2.7V to 5.5V, V_{OUT} : 0.9V to 1.6V, Regulated Output, I_Q : 9 μ A, I_{SD} : <1 μ A, MS Package
LTC3252	Dual 250mA (I_{OUT}), Spread Spectrum, Inductorless (CS), Step-Down DC/DC Converter	Up to 90% Efficiency, V_{IN} : 2.7V to 5.5V, V_{OUT} : 0.9V to 1.6V, I_Q : 60 μ A, I_{SD} : <1 μ A, DFN Package
LTC3405/LTC3405A	300mA (I_{OUT}), 1.5MHz, Synchronous Step-Down DC/DC Converter	95% Efficiency, V_{IN} : 2.7V to 6V, $V_{OUT(MIN)}$: 0.8V, I_Q : 20 μ A, I_{SD} : <1 μ A, ThinSOT Package
LTC3406/LTC3406B	600mA (I_{OUT}), 1.5MHz, Synchronous Step-Down DC/DC Converter	95% Efficiency, V_{IN} : 2.5 to 5.5V, $V_{OUT(MIN)}$: 0.6V, I_Q : 20 μ A, I_{SD} : <1 μ A, ThinSOT Package
LTC3411	1.25A (I_{OUT}), 4MHz, Synchronous Step-Down DC/DC Converter	95% Efficiency, V_{IN} : 2.5V to 5.5V, $V_{OUT(MIN)}$: 0.8V, I_Q : 60 μ A, I_{SD} : <1 μ A, MS Package
LTC3412	2.5A (I_{OUT}), 4MHz, Synchronous Step-Down DC/DC Converter	95% Efficiency, V_{IN} : 2.5V to 5.5V, $V_{OUT(MIN)}$: 0.8V, I_Q : 60 μ A, I_{SD} : <1 μ A, TSSOP16E Package
LTC3440	600mA (I_{OUT}), 2MHz, Synchronous Buck-Boost DC/DC Converter	95% Efficiency, V_{IN} : 2.5V to 5.5V, V_{OUT} : 2.5V to 5.5V, I_Q : 25 μ A, I_{SD} : <1 μ A, MS Package
LTC3441	1.2A (I_{OUT}), 1MHz, Synchronous Buck-Boost DC/DC Converter	95% Efficiency, V_{IN} : 2.4V to 5.5V, V_{OUT} : 2.4V to 5.25V, I_Q : 25 μ A, I_{SD} : <1 μ A, DFN Package

3250fa

Looking for pricing, stock, or lifecycle information?

Click below to explore more details on WIN SOURCE:

-  [View LTC3250ES6-1.5#TRPBF on WIN SOURCE](#)
-  [Linear Technology](#) Information

Optimize Your Supply Chain with WIN SOURCE Solutions

-  Global Sourcing Solution
-  Obsolete Management
-  Cost Control Management
-  Shortage Management
-  Alternative Solution
-  Excess Inventory Management