



**THE DATASHEET OF  
LTC3445EUF#PBF**



# I<sup>2</sup>C Controllable Buck Regulator with Two LDOs in a 4mm × 4mm QFN

## FEATURES

### Buck Regulator

- High Efficiency: Up to 93%
- 600mA Output Current ( $V_{CC1} = 3V$ ,  $V_{OUT} = 1.3V$ )
- Programmable Output Voltage: 0.85V to 1.55V
- 2.5V to 5.5V Input Voltage Range
- 1.5MHz Constant Frequency or Spread Spectrum Option
- Soft-Start

### LDOs

- Two LDO Regulators: 0.3V Dropout at 50mA

### PowerPath Controller

- Dynamically Regulates  $V_{CC}$  BATT

### I<sup>2</sup>C

- Standard (100kHz) or Fast Mode (400kHz)
- 24-Lead (4mm × 4mm) QFN Package

## APPLICATIONS

- Intel's Microprocessor Supply (PXA27X)
- Portable Instruments

LT, LTC and LT are registered trademarks of Linear Technology Corporation.  
 Burst Mode is a registered trademark of Linear Technology Corporation.  
 PowerPath is a trademark of Linear Technology Corporation.  
 I<sup>2</sup>C is a trademark of Philips Electronics N.V.  
 Protected by U.S. Patents, including 5481178, 6580258, 6304066, 6127815, 6498466,  
 6611131, Spread Spectrum patent pending.

## DESCRIPTION

The LTC<sup>®</sup>3445 contains a high efficiency monolithic synchronous current mode buck regulator, two LDO regulators, a PowerPath™ controller and an I<sup>2</sup>C™ interface.

The buck regulator has a 6-bit programmable output range of 0.85V to 1.55V. Also, the buck regulator uses either a constant (1.5MHz) or a spread spectrum switching frequency. Using the spread spectrum option allows for a lower noise regulated output as well as low noise at the input. In addition, the regulated output voltage slew rate is programmable via the I<sup>2</sup>C interface.

The LTC3445 contains two LDO voltage regulators. The regulator output voltages are externally resistor programmable. Each LDO is capable of delivering up to 50mA.

The LTC3445 contains control circuitry (PowerPath) for automatic back-up battery selection.  $V_{BACKUP}$  is typically a coin cell.

Typical supply current during operation is only 360μA and drops to 27μA in shutdown. The 2.5V to 5.5V input voltage range makes the LTC3445 ideal for single Li-Ion battery-powered applications. Automatic Burst Mode<sup>®</sup> operation increases efficiency at light loads, further extending battery life.

## TYPICAL APPLICATION

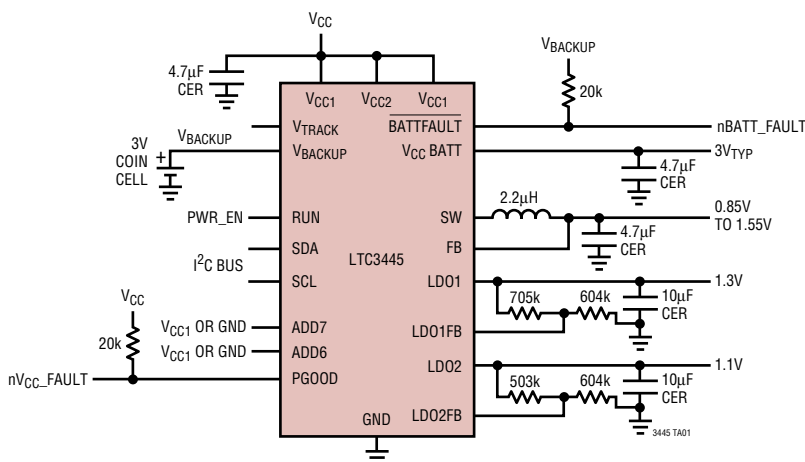

Efficiency and Power Loss  
vs Load Current,  $V_{CC1} = 3.6V$

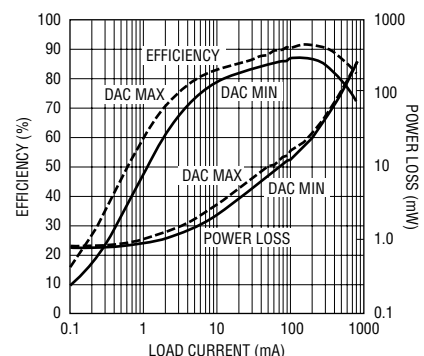

3445 TA01b

## ABSOLUTE MAXIMUM RATINGS

(Note 1)

$V_{CC1}$ , $V_{CC2}$ , SDA, SCL Voltages .....	-0.3V to 6V
RUN, $V_{TRACK}$ , $V_{BACKUP}$ , PGOOD, ADD7, ADD6, FB, $V_{CC}$ BATT, BATTFAULT Voltages .....	-0.3V to $V_{CC1}$
SW Voltage .....	-0.3V to ( $V_{CC1} + 0.3V$ )
LDO1FB, LDO2FB Voltages .....	-0.3V to $V_{CC2}$
LDO1, LDO2 Voltages .....	-0.3V to ( $V_{CC2} + 0.3V$ )
LDO1, LDO2 Source Current .....	50mA
$V_{CC}$ BATT Source Current .....	8mA
P-Channel Switch Source Current (DC) .....	800mA
N-Channel Switch Sink Current (DC) .....	800mA
Peak SW Sink and Source Current .....	1.3A
LDO1, LDO2, $V_{CC}$ BATT Output Short-Circuit Duration .....	Indefinite
Operating Temperature Range (Note 2) ...	-40°C to 85°C
Junction Temperature (Note 3) .....	125°C
Storage Temperature Range .....	-65°C to 125°C

## PACKAGE/ORDER INFORMATION

UF PACKAGE  
24-LEAD (4mm × 4mm) PLASTIC QFN  
 $T_{JMAX} = 125^{\circ}C$ ,  $\theta_{JA} = 37^{\circ}C/W$ ,  $\theta_{JC} = 2.6^{\circ}C/W$   
EXPOSED PAD (PIN 25) IS GND, MUST BE SOLDERED TO PCB

ORDER PART NUMBER	UF PART MARKING
LTC3445EUF	3445

**Order Options** Tape and Reel: Add #TR  
Lead Free: Add #PBF Lead Free Tape and Reel: Add #TRPBF  
Lead Free Part Marking: <http://www.linear.com/leadfree/>

Consult LTC Marketing for parts specified with wider operating temperature ranges.

## ELECTRICAL CHARACTERISTICS

The ● denotes the specifications which apply over the full operating temperature range, otherwise specifications are at  $T_A = 25^{\circ}C$ .  $V_{CC1} = V_{CC2} = 3.6V$ , unless otherwise noted.

SYMBOL	PARAMETER	CONDITIONS	MIN	TYP	MAX	UNITS
$V_{CC1}$ , $V_{CC2}$	Input Voltage Range		● 2.5		5.5	V
RUN	Run Threshold		● 0.3	1	1.5	V
PGOOD	Reports Undervoltage of any Regulator	PGOOD = 0.4V	● 3			mA
$I_S$	DC Bias Current (Shutdown)	RUN = 0		27	50	$\mu A$
	DC Bias Current (Buck, LDO1, LDO2 Disabled)	RUN = $V_{CC1}$		105	150	$\mu A$
<b>Buck Regulator</b>						
$R_{FB}$	Feedback Resistance			340		k $\Omega$
$V_{OUT(MIN)}$	Regulated Output Voltage	$I_{OUT} = 100mA$ , Burst Mode Operation Disabled	● 0.824	0.850	0.875	V
$V_{OUT(MAX)}$	Regulated Output Voltage	$I_{OUT} = 100mA$ , Burst Mode Operation Disabled	● 1.504	1.55	1.597	V
$V_{OUT(STEP)}$	Output Voltage Step Size (0 to 48)	$I_{OUT} = 100mA$	● 13.1	14.7	16.1	mV
	Output Voltage Slew Rate = 00	$I_{OUT} = 100mA$ , $V_{OUT} = 0.85V$ to 1.55V		11.3		mV/ $\mu s$
	Output Voltage Slew Rate = 01	$I_{OUT} = 100mA$ , $V_{OUT} = 0.85V$ to 1.55V		7.5		mV/ $\mu s$
	Output Voltage Slew Rate = 10	$I_{OUT} = 100mA$ , $V_{OUT} = 0.85V$ to 1.55V		3.8		mV/ $\mu s$
	Output Voltage Slew Rate = 11	$I_{OUT} = 100mA$ , $V_{OUT} = 0.85V$ to 1.55V		0.9		mV/ $\mu s$
$I_{PK}$	Peak Inductor Current	$V_{CC1} = 3V$ , $V_{FB} = 0.5V$ or $V_{OUT} = 90\%$ , Duty Cycle < 35%	0.75	1	1.25	A
$V_{LOADREG}$	Output Voltage Load Regulation			0.5		%

3445fa

## ELECTRICAL CHARACTERISTICS

The ● denotes the specifications which apply over the full operating temperature range, otherwise specifications are at  $T_A = 25^\circ\text{C}$ .  $V_{CC1} = V_{CC2} = 3.6\text{V}$ , unless otherwise noted.

SYMBOL	PARAMETER	CONDITIONS	MIN	TYP	MAX	UNITS
$I_S$	Additional Input DC Bias Current For Buck Active Mode Sleep Mode	(Note 4) $V_{OUT} = 90\%$ , $I_{LOAD} = 0\text{A}$		220		$\mu\text{A}$
		$V_{OUT} = 103\%$ , $I_{LOAD} = 0\text{A}$		6		$\mu\text{A}$
$f_{OSC}$	Nominal Oscillator Frequency	$V_{OUT} = 100\%$ $V_{OUT} = 0\text{V}$	● 1.2	1.5 300	1.8	MHz kHz
$R_{PFET}$	$R_{DS(ON)}$ of P-Channel FET	$I_{SW} = 100\text{mA}$		0.45		$\Omega$
$R_{NFET}$	$R_{DS(ON)}$ of N-Channel FET	$I_{SW} = -100\text{mA}$		0.325		$\Omega$
$I_{LSW}$	SW Leakage	$V_{RUN} = 0\text{V}$ , $V_{SW} = 0\text{V}$ or $5\text{V}$ , $V_{CC1} = 5\text{V}$		1		$\mu\text{A}$
<b>LDO1</b>						
$I_S$	Additional DC Bias for LDO1			23	30	$\mu\text{A}$
$V_{OUT}$	Regulated Output Voltage	$2.5\text{V} < V_{IN} < 5.5\text{V}$ , $1\text{mA} < I_{LOAD} < 50\text{mA}$	0.582		$V_{CC2} - 0.3$	V
	Line Regulation	$\Delta V_{CC2} = 2.5\text{V}$ to $5.5\text{V}$ , $I_{LOAD} = 1\text{mA}$ , $V_{OUT} = 1.2\text{V}$		1	5	mV
	Load Regulation	$V_{CC2} = 2.5\text{V}$ , $\Delta I_{LOAD} = 1\text{mA}$ to $50\text{mA}$ , $V_{OUT} = 1.2\text{V}$			15	mV
	Dropout Voltage	$I_{LOAD} = 50\text{mA}$		0.3		V
	$V_{FB}$	LDO Feedback Voltage	$I_{LOAD} = 0\text{mA}$	● 0.582	0.6	0.618
<b>LDO2</b>						
$I_S$	Additional DC Bias for LDO2			23	30	$\mu\text{A}$
$V_{OUT}$	Regulated Output Voltage	$2.5\text{V} < V_{IN} < 5.5\text{V}$ , $1\text{mA} < I_{LOAD} < 50\text{mA}$	0.582		$V_{CC2} - 0.3$	V
	Line Regulation	$\Delta V_{CC2} = 2.5\text{V}$ to $5.5\text{V}$ , $I_{LOAD} = 1\text{mA}$ , $V_{OUT} = 1.2\text{V}$		1	5	mV
	Load Regulation	$V_{CC2} = 2.5\text{V}$ , $\Delta I_{LOAD} = 1\text{mA}$ to $50\text{mA}$ , $V_{OUT} = 1.2\text{V}$			15	mV
	Dropout Voltage	$I_{LOAD} = 50\text{mA}$		0.3		V
	$V_{FB}$	LDO Feedback Voltage	$I_{LOAD} = 0\text{mA}$	● 0.582	0.6	0.618
<b>PowerPath Controller</b>						
$V_{TRACK}$	Tracked Input Voltage		3		$V_{CC1} - 0.2$	V
$V_{TRACK} - V_{CC\ BATT}$	Tracked Output Voltage at $V_{CC\ BATT}$	$3\text{V} < V_{TRACK} < V_{CC1} - 0.2\text{V}$	-0.2	0	0.2	V
$V_{BACKUP}$	Backup Battery Voltage		2		5.5	V
$I_{BACKUP}$	Backup Battery Bias Current	$V_{CC1} = V_{TRACK} = 0\text{V}$ , $V_{BACKUP} = 2.5\text{V}$		4	6.5	$\mu\text{A}$
$V_{CC\ BATT}$	$V_{CC\ BATT}$ Output	$V_{TRACK} = 0\text{V}$ , $V_{CC1} = 4\text{V}$ , $I_{VCCBATT} = 8\text{mA}$	2.85	3	3.1	V
$I_{VCCBATT}$	Max $V_{CC\ BATT}$ Output Current	$V_{CC1} = 2.5\text{V}$		8		mA
BATTFAULT	$V_{CC1}$ High Level (Good)	Where BATTFAULT Goes High	2.65	2.8	2.9	V
	$V_{CC1}$ Low Level (Bad)	Where BATTFAULT Goes Low	2.4	2.5	2.6	V
	Hysteresis	$V_{CC1} = 0\text{V}$ to $4.2\text{V}$ , $4.2$ to $0\text{V}$		0.3		V
<b>I<sup>2</sup>C Interface</b>						
$f_{I2C(MAX)}$	Maximum I <sup>2</sup> C Operating Frequency	(Note 5)			400	kHz
$t_{BUF}$	Bus Free Time Between Stop and Start Condition	(Note 5)			1.3	$\mu\text{s}$
$t_{HD(RSTA)}$	Hold Time After (Repeated) Start Condition	(Note 5)			600	ns

## ELECTRICAL CHARACTERISTICS

The ● denotes the specifications which apply over the full operating temperature range, otherwise specifications are at  $T_A = 25^\circ\text{C}$ .  $V_{CC1} = V_{CC2} = 3.6\text{V}$ , unless otherwise noted.

SYMBOL	PARAMETER	CONDITIONS	MIN	TYP	MAX	UNITS
$t_{SU(RSTA)}$	Repeated Start Condition Setup Time	(Note 5)			600	ns
$t_{SU(STOP)}$	Stop Condition Setup Time	(Note 5)			600	ns
$t_{HD(DIN)}$	Data Hold Time, Input	(Note 5)			0	ns
$t_{SU(DAT)}$	Data Setup Time	(Note 5)			100	ns
$V_{THR}$	SCL and SDA Logic Input Threshold			1.8		V
$V_{HYS}$	SCL and SDA Logic Input Hysteresis	(Note 5)		50		mV
$I_{LVTRACK}$	$V_{TRACK}$ Leakage	$V_{CC} = 3.6\text{V}$		1.44	2.2	$\mu\text{A}$
$I_{LVBACKUP}$	$V_{BACKUP}$ Leakage	$V_{CC} = 3.6\text{V}$	●		1	$\mu\text{A}$
$I_{LADD7}$	ADD7 Leakage	$V_{CC} = 3.6\text{V}$	●		1	$\mu\text{A}$
$I_{LADD6}$	ADD6 Leakage	$V_{CC} = 3.6\text{V}$	●		1	$\mu\text{A}$
$I_{LSCL}$	SCL Leakage	$V_{CC} = 3.6\text{V}$	●		1	$\mu\text{A}$
$I_{LSDA}$	SDA Leakage	$V_{CC} = 3.6\text{V}$	●		1	$\mu\text{A}$
$I_{LLD01}$	LDO1 Leakage	$V_{CC} = 3.6\text{V}$ , RUN = 0	●		1	$\mu\text{A}$
$I_{LLD02}$	LDO2 Leakage	$V_{CC} = 3.6\text{V}$ , RUN = 0	●		1	$\mu\text{A}$
$I_{LLD01FB}$	LDO1FB Leakage	$V_{CC} = 3.6\text{V}$ , RUN = 0	●		1	$\mu\text{A}$
$I_{LLD02FB}$	LDO2FB Leakage	$V_{CC} = 3.6\text{V}$ , RUN = 0	●		1	$\mu\text{A}$
$I_{LBATTFault}$	BATTFault Leakage	$V_{CC} = 3.6\text{V}$	●		1	$\mu\text{A}$
$I_{FB1,2}$	LDO Feedback Input Current	$V_{FB1} = 0.6\text{V}$	●		1	$\mu\text{A}$

**Note 1:** Absolute Maximum Ratings are those values beyond which the life of a device may be impaired.

**Note 2:** The LTC3445EUF is guaranteed to meet performance specifications from  $0^\circ\text{C}$  to  $70^\circ\text{C}$ . Specifications over the  $-40^\circ\text{C}$  to  $85^\circ\text{C}$  operating temperature range are assured by design, characterization and correlation with statistical process controls.

**Note 3:**  $T_J$  is calculated from the ambient temperature,  $T_A$ , and power dissipation,  $P_D$ , according to the following formula:

$$T_J = T_A + P_D \cdot 37^\circ\text{C/W}$$

**Note 4:** Dynamic supply current is higher due to the gate charge being delivered at the switching frequency.

**Note 5:** Determined by design, not production tested.

## TYPICAL PERFORMANCE CHARACTERISTICS

Supply Current vs Supply Voltage

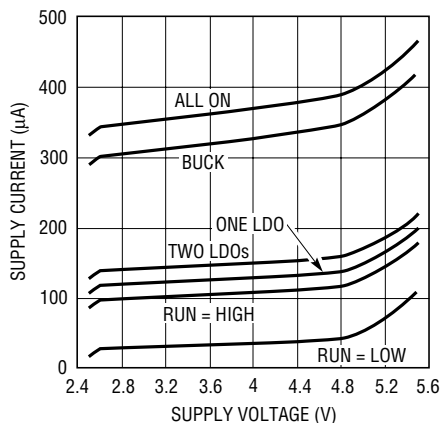

3445 G01

$V_{OUT}$  vs DAC

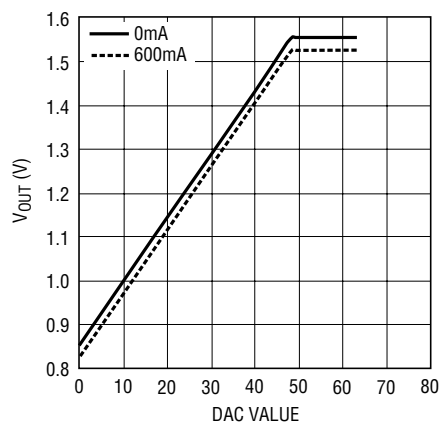

3445 G02

$V_{OUT}$  Step Size vs DAC

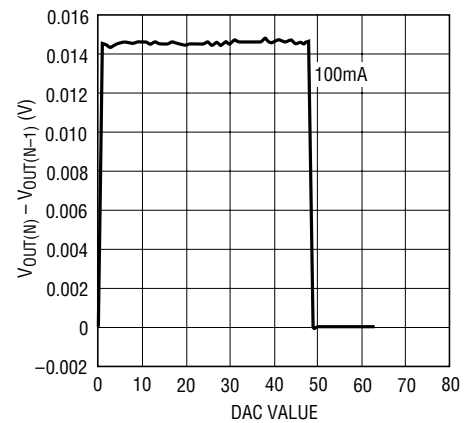

3445 G03

3445fa

# TYPICAL PERFORMANCE CHARACTERISTICS

**Buck Efficiency and Power Loss vs Load Current,  $V_{CC1} = 2.5V$**

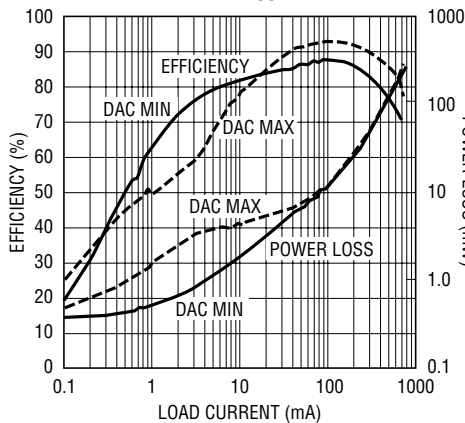

3445 G04

**Buck Efficiency and Power Loss vs Load Current,  $V_{CC1} = 4.2V$**

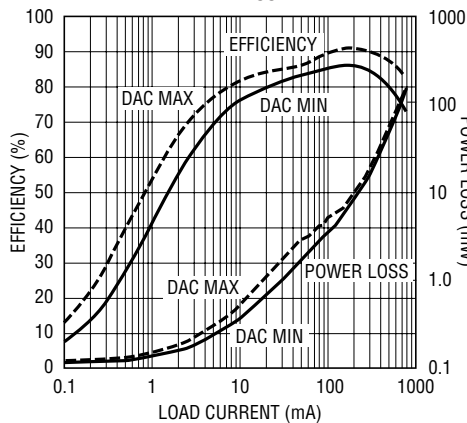

3445 G05

**Buck Output Voltage vs Load Current**

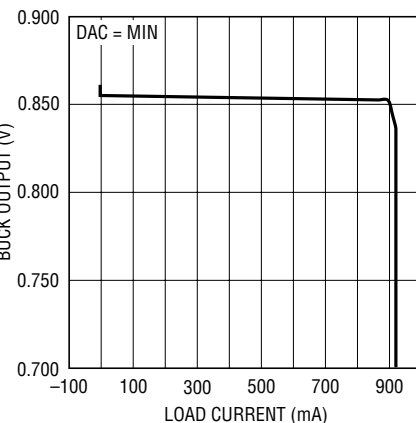

3445 G06

**Buck Output Voltage vs Load Current**

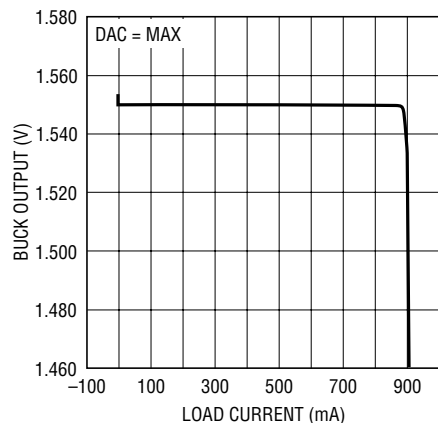

3445 G07

**$I_{CC2}$  vs Temperature (RUN =  $V_{CC1}$ )**

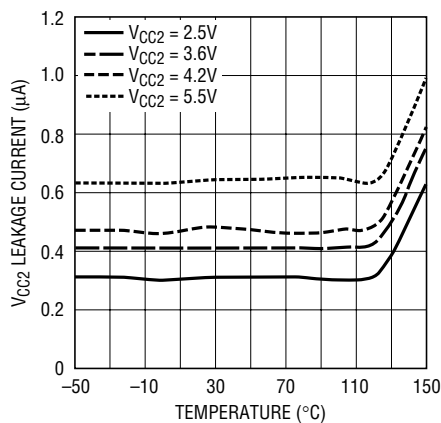

3445 G08

**$I_{CC2}$  vs Temperature (RUN = 0V)**

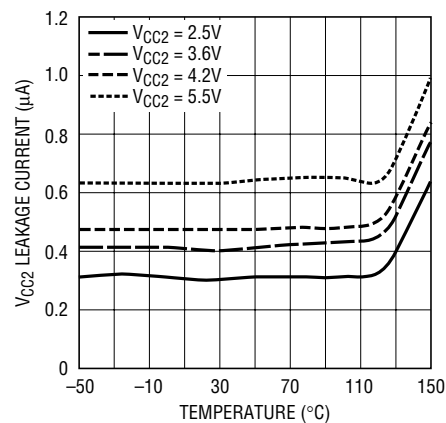

3445 G09

**$R_{DS(ON)}$  vs Input Voltage**

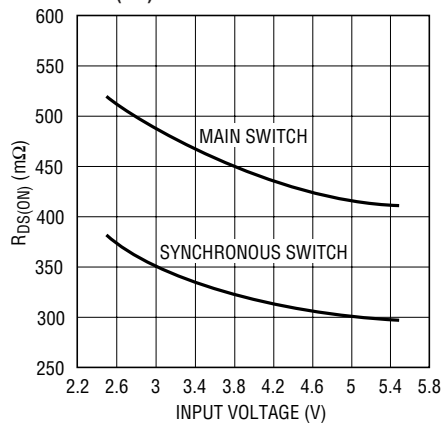

3445 G10

**Synchronous Switch  $R_{DS(ON)}$  vs Temperature**

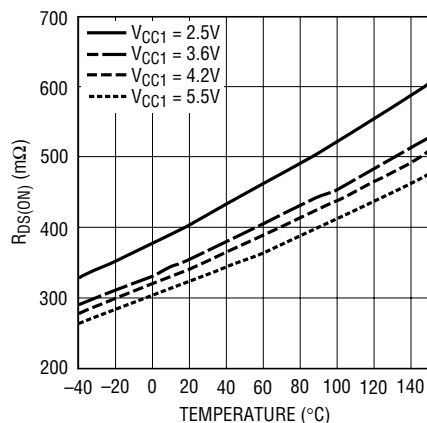

3445 G11

**Main Switch  $R_{DS(ON)}$  vs Temperature**

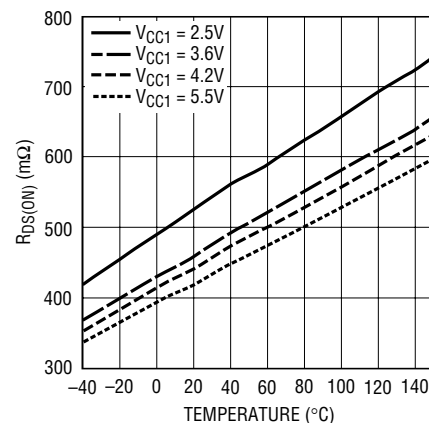

3445 G12

# TYPICAL PERFORMANCE CHARACTERISTICS

**Slew Rates DAC Min to DAC Max**

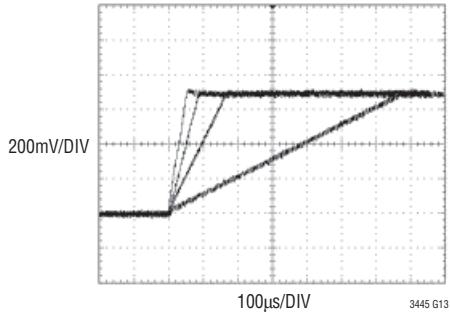

**Buck (DAC = Min)  
100mA to 300mA Load Step**

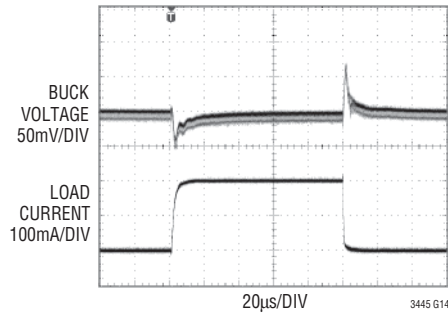

**Buck (DAC = Max)  
100mA to 400mA Load Step**

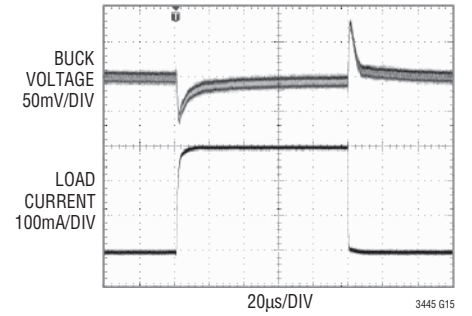

**Buck Switching Frequency  
vs V<sub>CC1</sub>**

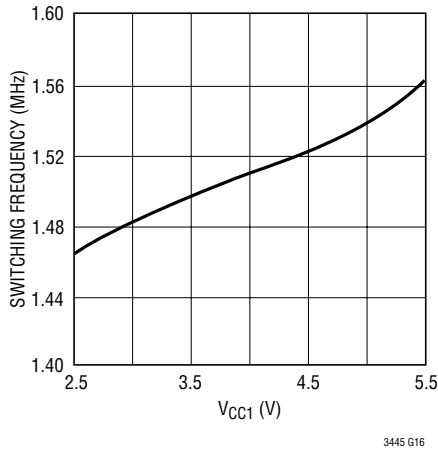

**Buck Switching Frequency  
vs Temperature**

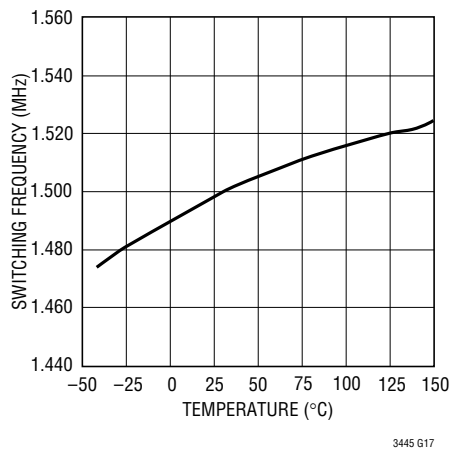

**Soft-Start (DAC = Min and Max)  
4.7Ω Load**

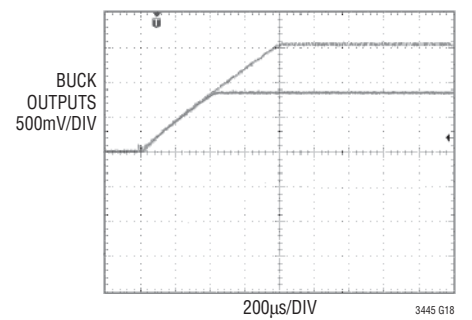

**V<sub>CC BATT</sub> vs V<sub>CC1</sub>**

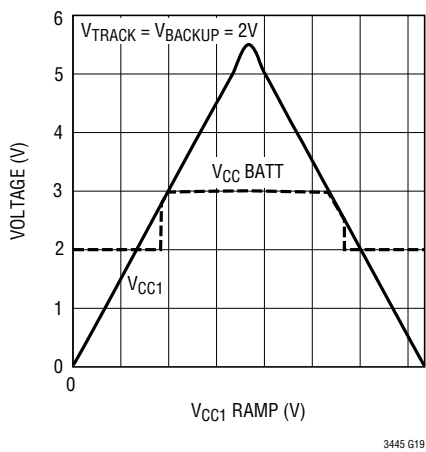

**V<sub>CC BATT</sub> vs V<sub>TRACK</sub>**

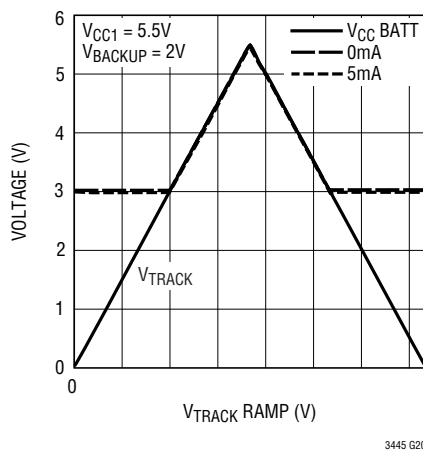

**PowerPath LDO Load Step  
1mA to 5.5mA**

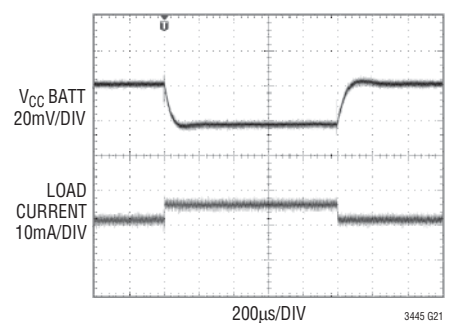

# TYPICAL PERFORMANCE CHARACTERISTICS

**LDO Reference Voltage vs Temperature**

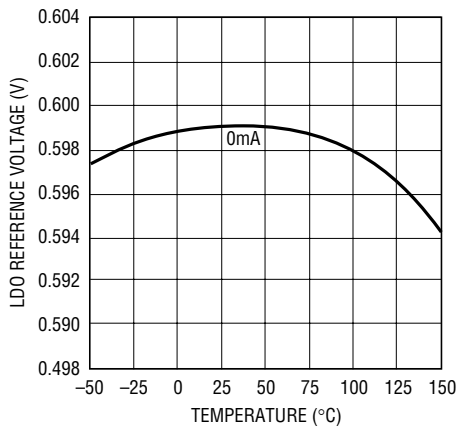

**LDO Reference Voltage vs Load Current**

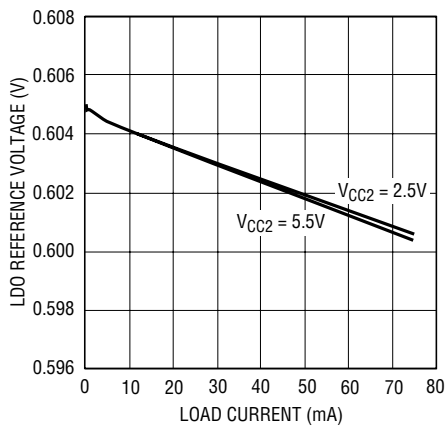

**LDO Output Voltage vs V<sub>CC2</sub>**

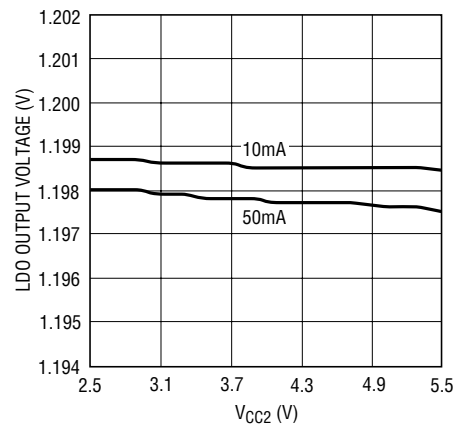

**LDO Output Voltage vs Load Current**

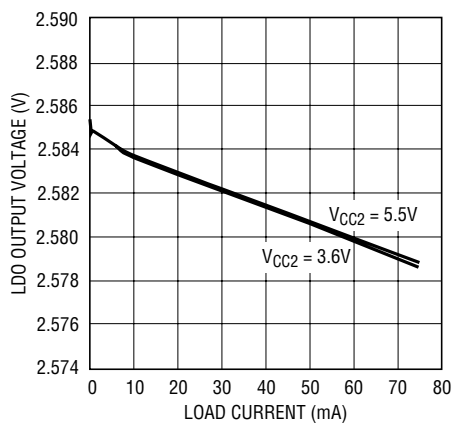

**LDO Output Voltage vs Load Current**

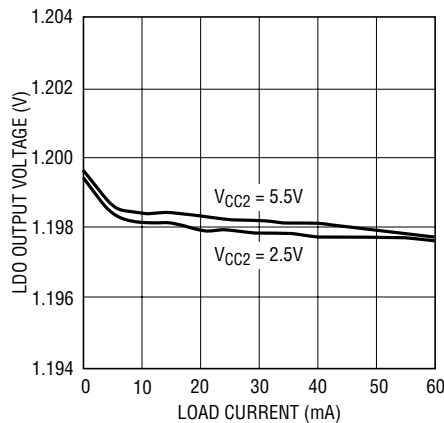

**LDO Dropout Voltage vs Load Current**

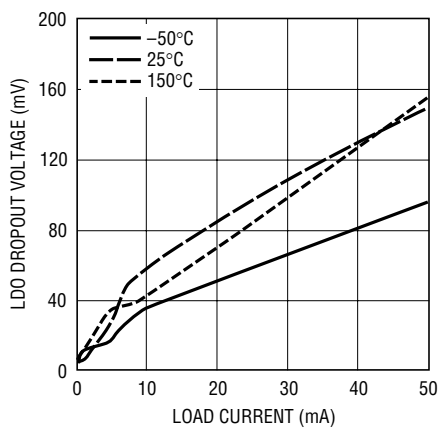

**LDO Load Step (10mA to 40mA)**

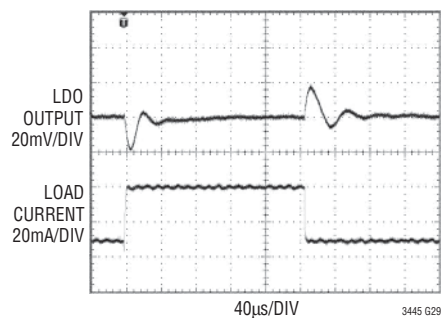

## PIN FUNCTIONS

**V<sub>TRACK</sub> (Pin 1):** Supply Sense that V<sub>CC</sub> BATT Tracks when above 3V. Must be  $\leq V_{CC1}$ .

**V<sub>BACKUP</sub> (Pin 2):** Back-Up Battery Input.

**V<sub>CC1</sub> (Pins 3, 10):** Power Supply (2.5V to 5.5V). Both V<sub>CC1</sub> pins must be connected externally to the 2.5V to 5.5V supply.

**PGOOD (Pin 4):** Fault Report (Undervoltage). Open-drain driver sinks current whenever LDO1, LDO2 or buck outputs are low.

**ADD7 (Pin 5):** I<sup>2</sup>C Strappable Address (Bit 7)—V<sub>CC1</sub> or ground.

**SDA (Pin 6):** I<sup>2</sup>C Data Input.

**NC (Pin 7):** Not Connected.

**SCL (Pin 8):** I<sup>2</sup>C Clock Input.

**ADD6 (Pin 9):** I<sup>2</sup>C Strappable Address (Bit 6)—V<sub>CC1</sub> or ground.

**GND (Pin 11):** Buck NFET Ground.

**NC (Pin 12):** Not Connected.

**NC (Pin 13):** Not Connected.

**SW (Pin 14):** Buck Regulator Switch.

**RUN (Pin 15):** Chip Enable. 1.5V enables the part. Forcing this pin below 0.3V shuts down the device. In shutdown, all functions are disabled, drawing <35 $\mu$ A supply current. Do not leave RUN floating. Must be  $\leq V_{CC1}$ .

**NC (Pin 16):** Not Connected.

**FB (Pin 17):** Buck Regulator Feedback.

**V<sub>CC</sub> BATT (Pin 18):** V<sub>CC</sub> BATT PowerPath Output.

**BATTFAULT (Pin 19):** Open-Drain Output. It is low when V<sub>CC1</sub> is low.

**LDO1FB (Pin 20):** LDO1 Regulator Sense.

**LDO1 (Pin 21):** LDO1 Regulator Output.

**V<sub>CC2</sub> (Pin 22):** LDO Regulator Supply Voltage.

**LDO2 (Pin 23):** LDO2 Regulator Output.

**LDO2FB (Pin 24):** LDO2 Regulator Sense.

**Exposed Pad (Pin 25):** Ground. Must be soldered to PCB ground for electrical contact and optimum thermal performance.

FUNCTIONAL DIAGRAMS

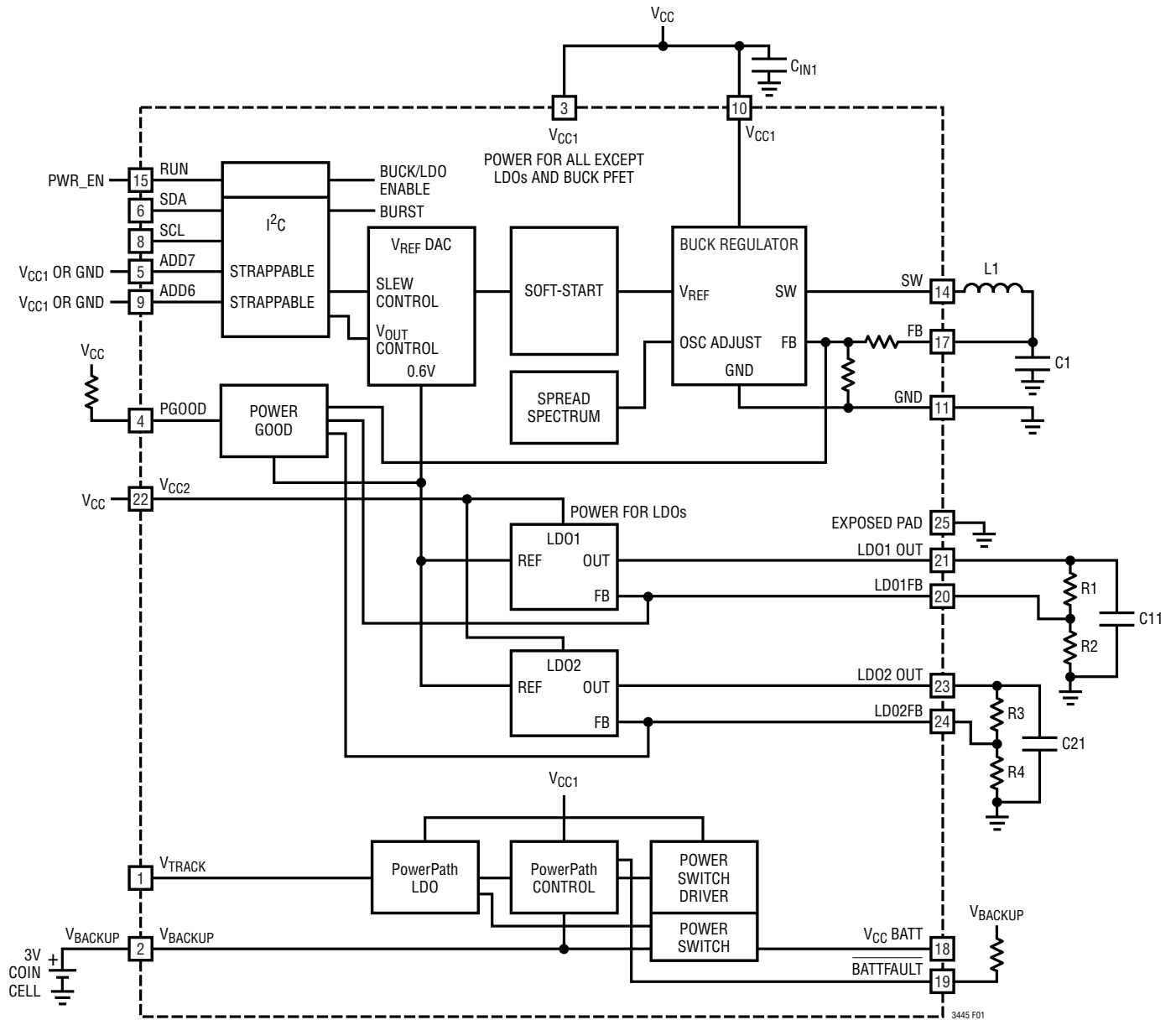

Figure 1

**FUNCTIONAL DIAGRAMS**

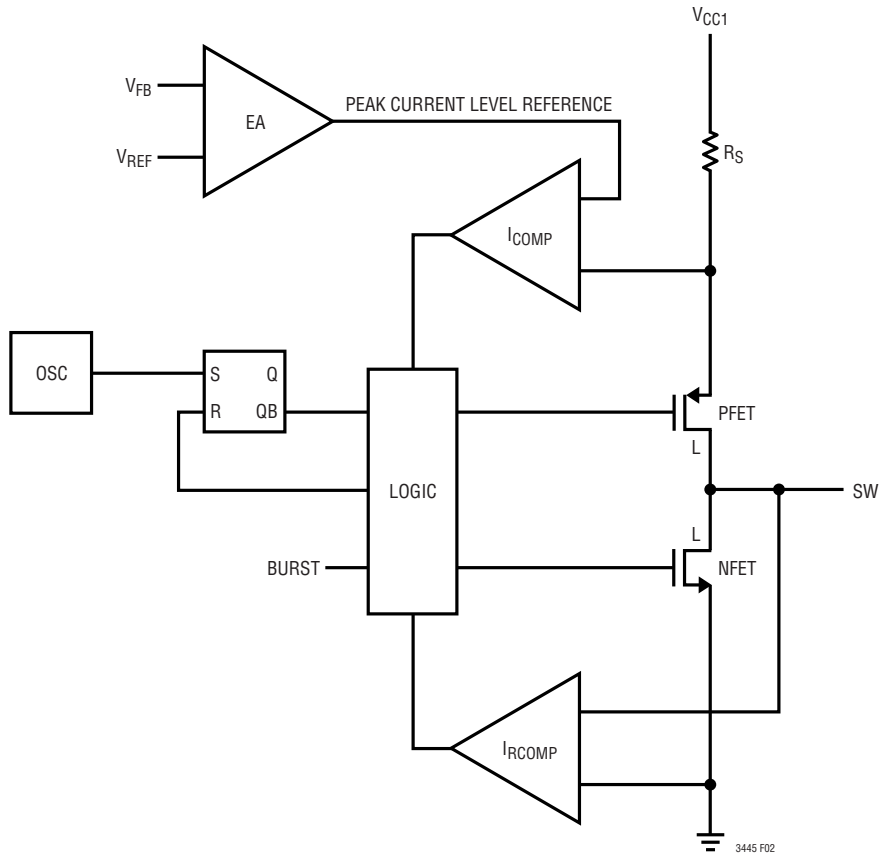
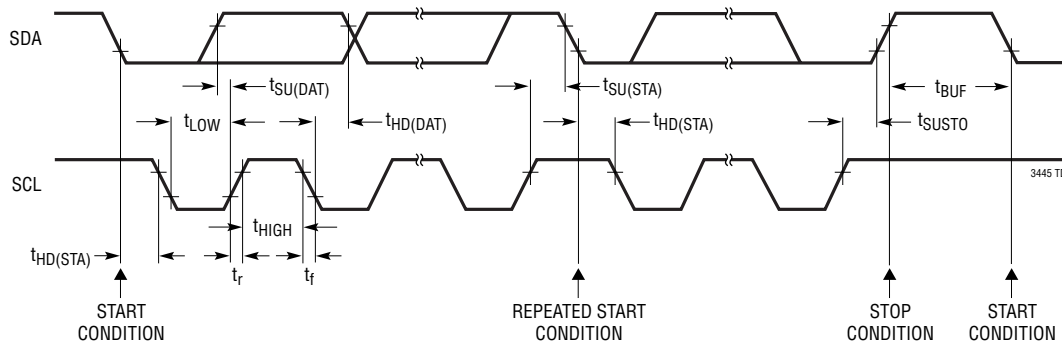

Figure 2. Buck Regulator Detail

## TIMING DIAGRAM



### I<sup>2</sup>C Fast Mode Timing Specifications (for Reference)

SYMBOL	PARAMETER	MIN	TYP	MAX	UNITS
$f_{I2C(MAX)}$	Maximum I <sup>2</sup> C Operating Frequency	0		400	kHz
$t_{BUF}$	Bus Free Time Between Stop and Start Condition	1.3			$\mu$ s
$t_{HD(RSTA)}$	Hold Time After (Repeated) Start Condition	0.6			$\mu$ s
$t_{SU(RSTA)}$	Repeated Start Condition Setup Time	0.6			$\mu$ s
$t_{SU(STOP)}$	Stop Condition Setup Time	0.6			$\mu$ s
$t_{HD(DAT)}$	Data Hold Time	0		0.9	ns
$t_{SU(DAT)}$	Data Setup Time	100			ns
$t_{LOW}$	Clock Low Period	1.3			$\mu$ s
$t_{HIGH}$	Clock High Period	0.6			$\mu$ s
$t_{SP}$	Pulse Width of Spikes Suppressed by Input Filter	0		50	ns
$t_f$	Clock, Data Fall Time (Note 1)	20 + 0.1 • $C_B$		300	ns
$t_r$	Clock, Data Rise Time (Note 1)	20 + 0.1 • $C_B$		300	ns

Note 1:  $C_B$  = Capacitance of one bus line.

## OPERATION (refer to Figure 1)

### BUCK REGULATOR

#### Main Control Loop

The LTC3445 uses a constant or spread spectrum frequency, current mode step-down architecture (Figure 2). Both the main (P-channel MOSFET) and synchronous (N-channel MOSFET) switches are internal. During normal operation, the internal top power MOSFET is turned on each cycle when the oscillator sets the RS latch, and turned off when the current comparator,  $I_{COMP}$ , resets the RS latch. The peak inductor current at which  $I_{COMP}$  resets

the RS latch is controlled by the output of error amplifier EA. When the load current increases, it causes a slight decrease in the feedback voltage, FB, relative to an internal reference voltage, which in turn, causes the EA's output voltage to increase until the average inductor current matches the new load current. While the top MOSFET is off, the bottom MOSFET is turned on until either the inductor current starts to reverse, as indicated by the current reversal comparator  $I_{RCMP}$ , or the beginning of the next clock cycle.

## OPERATION (refer to Figure 1)

### Burst Mode Operation

The LTC3445 is capable of Burst Mode operation, in which the internal power MOSFETs operate intermittently based on load demand.

In Burst Mode operation, the peak current of the inductor is set to approximately 200mA regardless of the output load. Each burst event can last from a few cycles at light loads to almost continuous cycling with short sleep intervals at moderate loads. In between these burst events, the power MOSFETs and any nonessential circuitry are turned off, reducing the buck regulator's quiescent current to 6 $\mu$ A. In this sleep state, the load current is being supplied solely from the output capacitor. As the output voltage droops, the EA's output rises above the sleep threshold, signaling the BURST comparator to trip and turn the top MOSFET on. This process repeats at a rate that is dependent on the load demand.

### Short-Circuit Protection

When the output is shorted to ground, the frequency of the oscillator is reduced to about 300kHz. This frequency foldback ensures that the inductor current has more time to decay, thereby preventing current runaway. The oscillator's frequency will progressively increase to 1.5MHz when  $V_{OUT}$  rises above 0V.

### Low Supply Operation

The LTC3445 will operate with input supply voltages as low as 2.5V, but the maximum allowable output current is reduced at this low voltage. Figure 3 shows the reduction in the typical maximum output current as a function of input voltage for various output voltages.

### Slope Compensation and Inductor Peak Current

Slope compensation provides stability in constant frequency architectures by preventing subharmonic oscillations at high duty cycles. It is accomplished internally by adding a compensating ramp to the inductor current signal at duty cycles in excess of 40%. Normally, this results in a reduction of maximum inductor peak current for duty cycles >40%. However, the LTC3445 uses a patent-pending scheme that counteracts this compensating ramp, which allows the maximum inductor peak current to remain unaffected throughout all duty cycles.

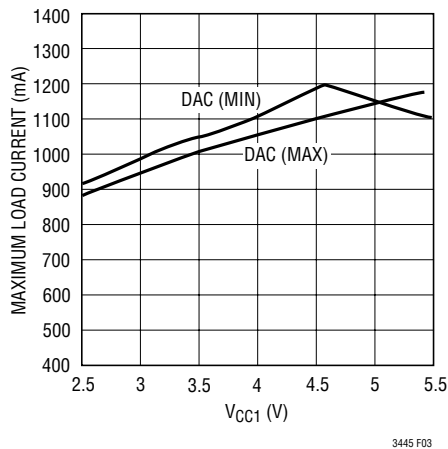

Figure 3. Buck Maximum Peak Current vs  $V_{CC1}$

### Spread Spectrum

The LTC3445 has a spread spectrum mode that can be enabled via two register bits. In the spread spectrum mode, the switching frequency is dithered about a center frequency of 1.5MHz. Spread spectrum lowers noise at the regulated output and at the input.

Figure 4 shows the noise reduction capabilities of the LTC3445 in spread spectrum mode. The percent spread of the frequency is controlled by two bits in register 5.

- 00 = 0% Spread
- 01 = 7.4% Spread
- 10 = 14.8% Spread
- 11 = 22.4% Spread

### DAC

The buck output voltage is controlled by programming a 6-bit DAC register (REG0[5:0]) and GO bit (REG2[0]). The output voltage range is 0.85V to 1.55V in ~15mV steps. The DAC setting range is from 0 to 48. Any settings above 48 will default to the 48 settings value. When the desired DAC setting is loaded, the GO bit needs to be changed from 0 to 1. Once the GO bit transition occurs,  $V_{OUT}$  will begin to change to the DAC setting loaded at that instant.

### Slew Rate

A 2-bit register is used to control the rate of change of  $V_{OUT}$  between DAC settings. The slew rate is controlled by stepping  $V_{OUT}$  to its new setting using a series of

3445fa

## OPERATION (refer to Figure 1)

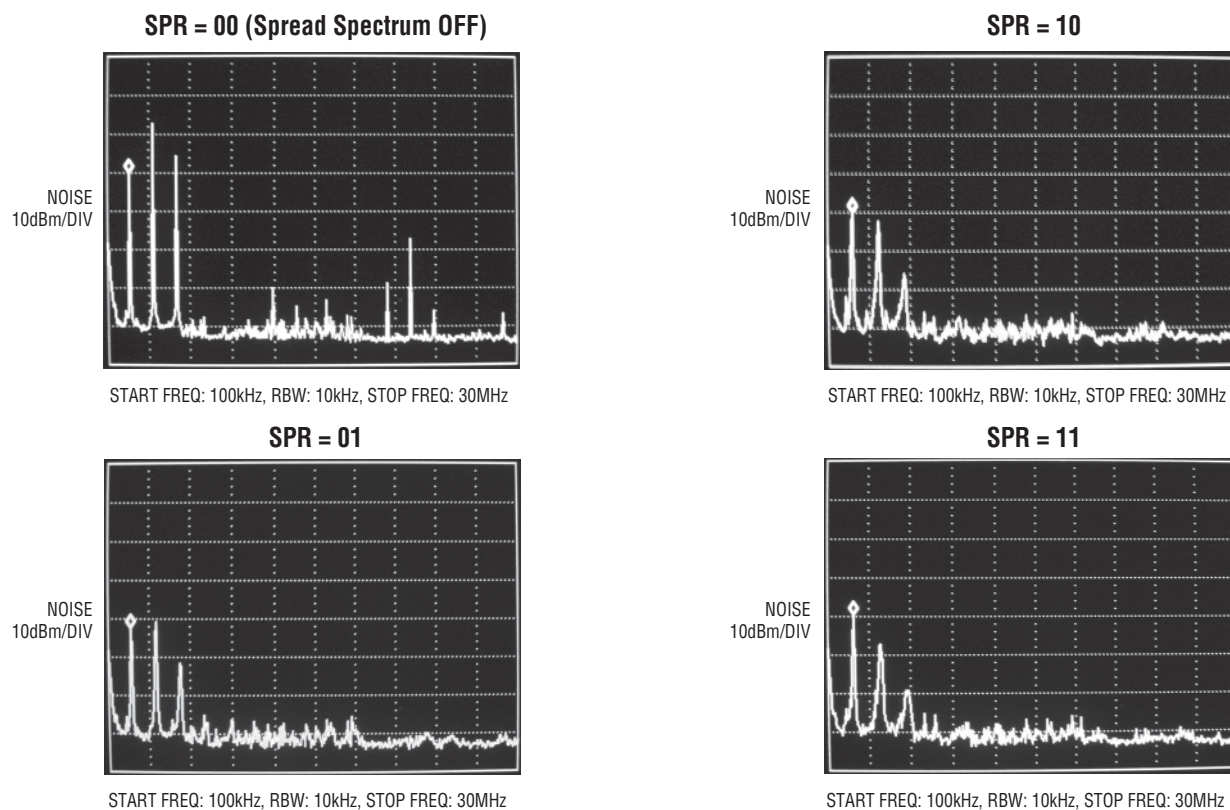

Figure 4. LTC3445 Output Noise Spectrum

micro-steps. The table below shows the register settings and corresponding slew rates.

REG1 [1:0]	SLEW RATE (mV/ $\mu$ s)
00	11.3
01	7.5
10	3.8
11	0.9

It should be noted that during DAC transistions, PGOOD fault reporting is disabled.

## LDO OPERATION

### Adjustable Operation

The LTC3445 contains two 50mA LDOs with an output voltage range of 0.6V to ( $V_{CC2} - 0.3V$ ). The output voltage is set by the ratio of two external resistors as shown in Figure 1. Each LDO serves the output voltage (Pin LDO<sub>x</sub>) in order to maintain a feedback voltage (Pin LDO<sub>x</sub>FB) of

0.6V. The current in R1 and R2 is then equal to  $0.6V/R2$ . The regulated voltage is equal to:

$$V_{OUT} = (0.6V/R2) \cdot (R1+R2)$$

### Frequency Compensation

The LTC3445 is frequency compensated by an internal dominant pole. An output capacitor of 2 $\mu$ F to 10 $\mu$ F is usually large enough to provide good stability. In order to insure stability, a feedforward capacitor may be needed between the output pin and the feedback pin. This cancels the pole formed by the stray capacitance in large value feedback resistors. Also, a feedback capacitor minimizes noise pickup and improves ripple rejection.

### PowerPath OPERATION

The output of the PowerPath ( $V_{CC}$  BATT) is controlled by a combination of three inputs: main battery ( $V_{CC1}$ ),  $V_{TRACK}$ , and  $V_{BACKUP}$ .

**OPERATION** (refer to Figure 1)

When  $V_{CC1}$  rises above 2.8V, the PowerPath’s LDO is enabled and set to the lesser of 3V or  $V_{CC1}$ . Once  $V_{TRACK}$  is 3V or higher, it controls the PowerPath’s LDO output ( $V_{CC BATT}$ ) voltage to within 200mV of  $V_{TRACK}$ . Note that  $V_{TRACK}$  needs to be less than or equal to  $V_{CC1}$ . When  $V_{TRACK}$  falls below 3V,  $V_{CC1}$  is used to regulate the PowerPath’s LDO ( $V_{CC BATT}$ ) to 3V. When  $V_{CC1}$  falls below 2.4V, the PowerPath LDO is disconnected and  $V_{BACKUP}$  is connected to  $V_{CC BATT}$ .

The PowerPath’s fault detection circuit uses an open-drain driver ( $BATTFault$ ) to report when the main battery is disconnected.

Figure 5 shows the different states of the PowerPath circuits. Typically,  $V_{BACKUP}$  is a coin cell; however, other types of back up power supplies may be used.

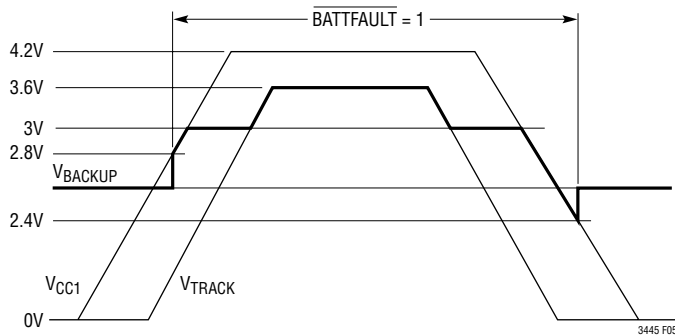

Figure 5

**I<sup>2</sup>C OPERATION**

- Simple 2-wire interface
- Multiple devices on same bus
- Idle bus must have SDA and SCL lines high
- LTC3445 is read/write
- Master controls bus
- Devices listen for unique address that precedes data

**General I<sup>2</sup>C Bus/SMBus Description**

I<sup>2</sup>C Bus and SMBus are reasonably similar examples of 2-wire, bidirectional, serial communications busses. Calling them 2-wire is not strictly accurate, as there is an implied third wire, which is the ground line. Large ground drops or spikes between the grounds of different parts on the bus can interrupt or disrupt communications, as the signals on the two wires are both inherently referenced to a ground which is expected to be common to all parts on the bus. Both bus types have one data line and one clock line which are externally pulled to a high voltage when they are not being controlled by a device on the bus. The devices on the bus can only pull the data and clock lines low, which makes it simple to detect if more than one device is trying to control the bus; eventually, a device will release a line and it will not pull high because another device is still holding it low. Pull-ups for the data and clock lines are usually provided by external discrete resistors, but external current sources can also be used. Since there are no dedicated lines to use to tell a given device if another device is trying to communicate with it, each device must have a unique address to which it will respond. The first part of any communication is to send out an address on the bus and wait to see if another device responds to it. After a response is detected, meaningful data can be exchanged between the parts.

Typically, one device will control the clock line at least most of the time and will normally be sending data to the other parts and polling them to send data back to it, and this device is called the master. There can certainly be more than one master, since there is an effective protocol to resolve bus contentions, and non-master (slave) devices can also control the clock to delay rising edges and give themselves more time to complete calculations or communications (clock stretching). Slave devices need to

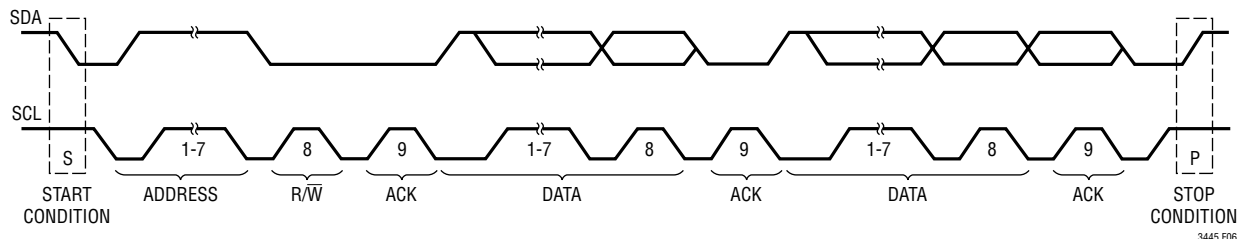

Figure 6. Typical 2-Wire Serial I<sup>2</sup>C Waveforms

## OPERATION (refer to Figure 1)

be able to control the data line to acknowledge communications from the master, and some devices will need to be able to send data back to the master; they will be in control of the data line while they are doing so. Many slave devices will have no need to stretch the clock signal and will have no ability to pull the clock line low, which is the case with the LTC3445.

Data is exchanged in the form of bytes, which are 8-bit packets. Any byte needs to be acknowledged by the slave (data line pulled low) or not acknowledged by the master (data line left high), so communications are broken up into 9-bit segments, one byte followed by one bit for acknowledging. For example, sending out an address consists of 7 bits of device address, 1 bit that signals whether a read or write operation will be performed, and then 1 more bit to allow the slave to acknowledge. There is no theoretical limit to how many total bytes can be exchanged in a given transmission.

I<sup>2</sup>C and SMBus are very similar specifications, SMBus having been derived from I<sup>2</sup>C. In general, SMBus is targeted to low power devices (particularly battery-powered ones) and emphasizes low power consumption, while I<sup>2</sup>C is targeted to higher speed systems where the power consumption of the bus is not so critical. I<sup>2</sup>C has three different specifications for three different maximum speeds, these being standard mode (100kHz max), fast mode (400kHz max) and HS mode (3.4MHz max). Standard and fast mode are not radically different, but HS mode is very different from a hardware and software perspective and requires an initiating command at standard or fast speed before data can start transferring at HS speed. SMBus simply specifies a 100kHz maximum speed.

### The START and STOP Conditions

When the bus is not in use, both SCL and SDA must be high. A bus master signals the beginning of a transmission with a START condition by transitioning SDA from high to low while SCL is high. When the master has finished communicating with the slave, it issues a STOP condition by transitioning SDA from low to high while SCL is high. The bus is then free for another transmission.

### Acknowledge

The acknowledge signal is used for handshaking between the master and the slave. An acknowledge signal (LOW active) as generated by the slave lets the master know that the latest byte of information was received. The acknowledge-related clock pulse is generated by the master. The transmitter master releases the SDA line (HIGH) during the acknowledge clock pulse. The slave receiver must pull down the SDA line during the acknowledge clock pulse so that it remains stable LOW during the HIGH period of this clock pulse.

When a slave receiver doesn't acknowledge the slave address (for example, it's unable to receive because it's performing some real-time function), the data line must be left HIGH by the slave. The master can then generate a STOP condition to abort the transfer.

If a slave receiver does acknowledge the slave address but, some time later in the transfer cannot receive any more data bytes, the master must again abort the transfer. This is indicated by the slave generating the not acknowledge on the first byte to follow. The slave leaves the data line HIGH and the master generates the STOP condition. The

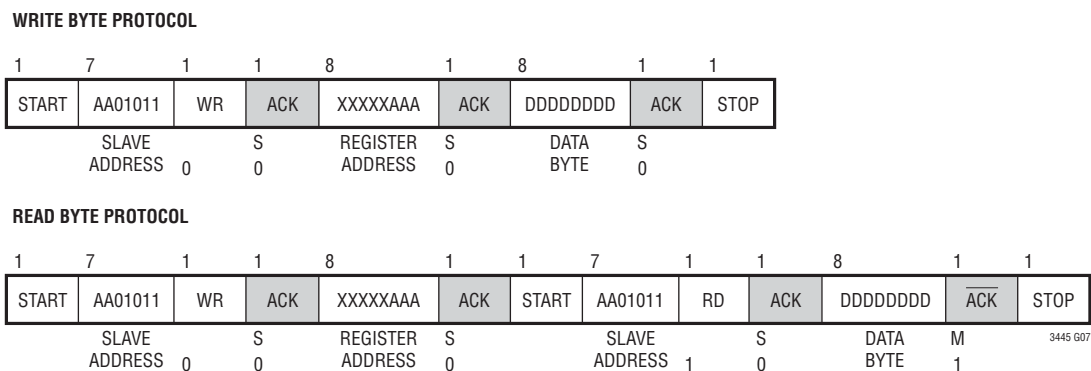

Figure 7

## OPERATION (refer to Figure 1)

data line is also left high by the slave and master after a slave has transmitted a byte of data to the master in a read operation, but this is a not-acknowledge that indicates that the data transfer is successful.

### 1<sup>2</sup>C Register Definitions (POR = 00 for all registers)

#### REG 0

7	0 (Logic Low)
6	0 (Logic Low)
5	Buck DAC5
4	Buck DAC4
3	Buck DAC3
2	Buck DAC2
1	Buck DAC1
0	Buck DAC0

#### REG 1

7	0 (Logic Low)
6	0 (Logic Low)
5	0 (Logic Low)
4	0 (Logic Low)
3	0 (Logic Low)
2	0 (Logic Low)
1	Slew Rate 1
0	Slew Rate 0

#### REG 2

7	0 (Logic Low)
6	0 (Logic Low)
5	0 (Logic Low)
4	STATUS—Buck Thermal Shutdown
3	STATUS—Buck PGOODb
2	STATUS—LDO2 PGOODb
1	STATUS—LDO1 PGOODb
0	Buck Update (GO Bit)

#### REG 3

7	PGOOD Blank Disable
6	0 (Logic Low)
5	0 (Logic Low)
4	0 (Logic Low)
3	BURST Mode
2	LDO2 Disable
1	LDO1 Disable
0	Buck Disable

### Commands Supported

The LTC3445 supports read byte and write byte commands. For the ACK bits, an S indicates that the slave is pulling the data line low and an M indicates that the master is effectively acknowledging by leaving the data line high.

### Data Transfer Timing for Write Commands

In order to help assure that bad data is not written into the part, data from a write command is only stored after a valid acknowledge has been performed. The part will detect that SDA is low on the rising edge of SCL that marks the end of the period in which the LTC3445 acknowledges the data write and then latch the data during the following SCL low period.

#### REG 5

7	0 (Logic Low)
6	% SPR1
5	% SPR0
4	(Logic Low)
3	(Logic Low)
2	(Logic Low)
1	(Logic Low)
0	(Logic Low)

## APPLICATIONS INFORMATION

### BUCK REGULATOR

The basic LTC3445 application circuit is shown on the first page of this data sheet. External component selection is driven by the load requirement and begins with the selection of L followed by  $C_{IN}$  and  $C_{OUT}$ .

#### Inductor Selection

For most applications, the value of the inductor will fall in the range of  $1\mu\text{H}$  to  $4.7\mu\text{H}$ . Its value is chosen based on the desired ripple current. Large value inductors lower ripple current and small value inductors result in higher ripple currents. Higher  $V_{CC1}$  or lower  $V_{OUT}$  also increases the ripple current as shown in Equation 1. A reasonable starting point for setting ripple current is  $\Delta I_L = 240\text{mA}$  (40% of 600mA).

$$\Delta I_L = \frac{1}{(f)(L)} V_{OUT} \left( 1 - \frac{V_{OUT}}{V_{CC1}} \right) \quad (1)$$

The DC current rating of the inductor should be at least equal to the maximum load current plus half the ripple current to prevent core saturation. Thus, a 720mA rated inductor should be enough for most applications (600mA + 120mA). For better efficiency, choose a low DC-resistance inductor.

The inductor value also has an effect on Burst Mode operation. The transition to low current operation begins when the inductor current peaks fall to approximately 200mA. Lower inductor values (higher  $\Delta I_L$ ) will cause this to occur at lower load currents, which can cause a dip in efficiency in the upper range of low current operation. In Burst Mode operation, lower inductance values will cause the burst frequency to increase.

#### Inductor Core Selection

Different core materials and shapes will change the size/current and price/current relationship of an inductor. Toroid or shielded pot cores in ferrite or permalloy materials are small and don't radiate much energy, but generally cost more than powdered iron core inductors with similar electrical characteristics. The choice of which style inductor to use often depends more on the price vs size

requirements and any radiated field/EMI requirements than on what the LTC3445 requires to operate. Table 1 shows some typical surface mount inductors that work well in LTC3445 applications.

Table 1

MANUFACTURER PART NUMBER	VALUE ( $\mu\text{H}$ )	DCR ( $\text{m}\Omega$ MAX)	MAX DC (A)	SIZE L $\times$ W $\times$ H ( $\text{mm}^3$ )
Sumida CDRH3D16/ HP2R2	2.2	72	1.2	$4.0 \times 4.0 \times 1.8$
Sumida CR434R7	4.7	109	1.15	$4.0 \times 4.5 \times 3.5$
TDK TDK7030T- 2R2M5R4	2.2	12	5.5	$7.3 \times 6.8 \times 3.2$
Coilcraft D03316P-222	2.2	12	7	$12.45 \times 9.4 \times 5.21$

#### $C_{IN}$ and $C_{OUT}$ Selection

In continuous mode, the source current of the top MOSFET is a square wave of duty cycle  $V_{OUT}/V_{CC1}$ . To prevent large voltage transients, a low ESR input capacitor sized for the maximum RMS current must be used. The maximum RMS capacitor current is given by:

$$C_{IN} \text{ required } I_{RMS} \cong I_{OMAX} \frac{[V_{OUT}(V_{CC1} - V_{OUT})]^{1/2}}{V_{CC1}} \quad (2)$$

This formula has a maximum at  $V_{CC1} = 2V_{OUT}$ , where  $I_{RMS} = I_{OUT}/2$ . This simple worst-case condition is commonly used for design because even significant deviations do not offer much relief. Note that the capacitor manufacturer's ripple current ratings are often based on 2000 hours of life. This makes it advisable to further derate the capacitor, or choose a capacitor rated at a higher temperature than required. Always consult the manufacturer if there is any question.

The selection of  $C_{OUT}$  is driven by the required effective series resistance (ESR). Typically, once the ESR requirement for  $C_{OUT}$  has been met, the RMS current rating generally far exceeds the  $I_{RIPPLE(P-P)}$  requirement. The output ripple  $\Delta V_{OUT}$  is determined by:

$$\Delta V_{OUT} \cong \Delta I_L \left( \text{ESR} + \frac{1}{8fC_{OUT}} \right) \quad (3)$$

## APPLICATIONS INFORMATION

where  $f$  = operating frequency,  $C_{OUT}$  = output capacitance and  $\Delta I_L$  = ripple current in the inductor. For a fixed output voltage, the output ripple is highest at maximum input voltage since  $\Delta I_L$  increases with input voltage.

Aluminum electrolytic and dry tantalum capacitors are both available in surface mount configurations. In the case of tantalum, it is critical that the capacitors are surge tested for use in switching power supplies. An excellent choice is the AVX TPS series of surface mount tantalum. These are specially constructed and tested for low ESR so they give the lowest ESR for a given volume. Other capacitor types include Sanyo POSCAP, Kemet T510 and T495 series, and Sprague 593D and 595D series. Consult the manufacturer for other specific recommendations.

### Using Ceramic Input and Output Capacitors

Higher values, lower cost ceramic capacitors are now becoming available in smaller case sizes. Their high ripple current, high voltage rating and low ESR make them ideal for switching regulator applications. Because the LTC3445's control loop does not depend on the output capacitor's ESR for stable operation, ceramic capacitors can be used freely to achieve very low output ripple and small circuit size.

However, care must be taken when ceramic capacitors are used at the input and the output. When a ceramic capacitor is used at the input and the power is supplied by a wall adapter through long wires, a load step at the output can induce ringing at the input,  $V_{CC1}$ . At best, this ringing can couple to the output and be mistaken as loop instability. At worst, a sudden inrush of current through the long wires can potentially cause a voltage spike at  $V_{CC1}$ , large enough to damage the part.

When choosing the input and output ceramic capacitors, choose the X5R or X7R dielectric formulations. These dielectrics have the best temperature and voltage characteristics of all the ceramics for a given value and size.

### Buck Output Voltage Programming

The LTC3445 has an internal resistor divider network tied to the FB pin. The output voltage is controlled by a DAC (6-bit register) whose setting is controlled by the I<sup>2</sup>C interface. The effective DAC bit range is from 0 to 48. Note

that any DAC settings above 48 defaults to the 48 setting. The DAC controls the  $V_{OUT}$  range of 0.85V to 1.55V in ~15mV steps. The default value for  $V_{OUT}$  is 1.35V and is reset to this value whenever  $V_{CC1}$  comes up.

When the DAC's value is changed, LTC3445 controls  $V_{OUT}$ 's slew rate via a 2-bit RATE register. The RATE register can be updated via the I<sup>2</sup>C interface. The slew rate can be set to approximately 0.9mV/ $\mu$ s, 3.8mV/ $\mu$ s, 7.5mV/ $\mu$ s or 11.3mV/ $\mu$ s. The default value for RATE is 10mV/ $\mu$ s and is reset to this value whenever  $V_{CC1}$  comes up.

The DAC and RATE values are not lost whenever the RUN pin is deasserted.

Once the DAC and RATE registers are programmed, a GO bit transition is required for the buck to update. This is accomplished by changing the GO bit (REG2[0]) from logic low to a logic high.

### Efficiency Considerations

The efficiency of a switching regulator is equal to the output power divided by the input power times 100%. It is often useful to analyze individual losses to determine what is limiting the efficiency and which change would produce the most improvement. Efficiency can be expressed as:

$$\text{Efficiency} = 100\% - (L1 + L2 + L3 + \dots)$$

where L1, L2, etc. are the individual losses as a percentage of input power.

Although all dissipative elements in the circuit produce losses, two main sources usually account for most of the losses in LTC3445 buck regulator circuits:  $V_{CC1}$  quiescent current and I<sup>2</sup>R losses. The  $V_{CC1}$  quiescent current loss dominates the efficiency loss at very low load currents whereas the I<sup>2</sup>R loss dominates the efficiency loss at medium to high load currents. In a typical efficiency plot, the efficiency curve at very low load currents can be misleading since the actual power lost is of no consequence as illustrated in Figure 8.

1. The  $V_{CC1}$  quiescent current is due to two components: the DC bias current as given in the Electrical Characteristics and the internal main switch and synchronous switch gate charge currents. The gate charge current results from switching the gate capacitance of the

## APPLICATIONS INFORMATION

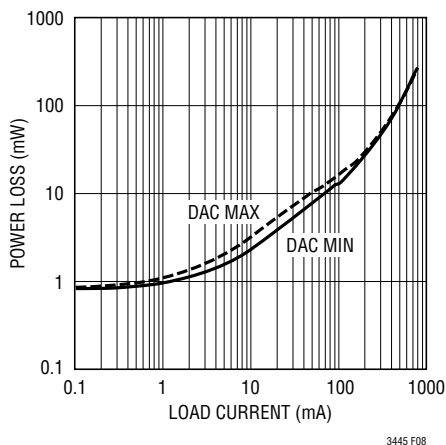

Figure 8. Power Loss vs Load Current,  $V_{CC1} = 3.6V$

internal power MOSFET switches. Each time the gate is switched from high to low to high again, a packet of charge,  $dQ$ , moves from  $V_{CC1}$  to ground. The resulting  $dQ/dt$  is the current out of  $V_{CC1}$  that is typically larger than the DC bias current. In continuous mode,  $I_{GATECHG} = f(Q_T + Q_B)$  where  $Q_T$  and  $Q_B$  are the gate charges of the internal top and bottom switches. Both the DC bias and gate charge losses are proportional to  $V_{CC1}$  and thus their effects will be more pronounced at higher supply voltages.

- $I^2R$  losses are calculated from the resistances of the internal switches,  $R_{SW}$ , and external inductor  $R_L$ . In continuous mode, the average output current flowing through inductor  $L$  is “chopped” between the main switch and the synchronous switch. Thus, the series resistance looking into the SW pin is a function of both top and bottom MOSFET  $R_{DS(ON)}$  and the duty cycle (DC) as follows:

$$R_{SW} = (R_{DS(ON)TOP})(DC) + (R_{DS(ON)BOT})(1 - DC)$$

The  $R_{DS(ON)}$  for both the top and bottom MOSFETs can be obtained from the Typical Performance Characteristics curves. Thus, to obtain  $I^2R$  losses, simply add  $R_{SW}$  to  $R_L$  and multiply the result by the square of the average output current.

Other losses including  $C_{IN}$  and  $C_{OUT}$  ESR dissipative losses and inductor core losses generally account for less than 2% total additional loss.

### Checking Transient Response

The regulator loop response can be checked by looking at the load transient response. Switching regulators take several cycles to respond to a step in load current. When a load step occurs,  $V_{OUT}$  immediately shifts by an amount equal to  $(\Delta I_{LOAD} \cdot ESR)$ , where ESR is the effective series resistance of  $C_{OUT}$ .  $\Delta I_{LOAD}$  also begins to charge or discharge  $C_{OUT}$ , which generates a feedback error signal.

The regulator loop then acts to return  $V_{OUT}$  to its steady-state value. During this recovery time  $V_{OUT}$  can be monitored for overshoot or ringing that would indicate a stability problem. For a detailed explanation of switching control loop theory, see Application Note 76.

A second, more severe transient is caused by switching in loads with large ( $>1\mu F$ ) supply bypass capacitors. The discharged bypass capacitors are effectively put in parallel with  $C_{OUT}$ , causing a rapid drop in  $V_{OUT}$ . No regulator can deliver enough current to prevent this problem if the load switch resistance is low and it is driven quickly. The only solution is to limit the rise time of the switch drive so that the load rise time is limited to approximately  $(25 \cdot C_{LOAD})$ . Thus, a  $10\mu F$  capacitor charging to 3.3V would require a  $250\mu s$  rise time, limiting the charging current to about 130mA.

### LDO REGULATORS

The LDOs in the LTC3445 are 50mA low dropout regulators with low quiescent and shutdown currents. Each device is capable of supplying 50mA at a dropout voltage of 300mV. The LDOs are current limited to greater than 50mA but less than 75mA. The output voltages of the LDOs are set with external resistive dividers according to the following formula:

$$V_{LDOOUT1} = 0.6(1 + R1/R2) \quad (4)$$

$$V_{LDOOUT2} = 0.6(1 + R3/R4) \quad (5)$$

### Output Capacitance and Transient Response

The LTC3445 LDOs are designed to be stable with a wide range of output capacitors. A minimum output capacitor of  $2.2\mu F$  with an ESR of  $3\Omega$  or less is recommended to

## APPLICATIONS INFORMATION

prevent oscillations. The LTC3445 LDOs are micropower devices and output transient response will be a function of output capacitance. Larger values of output capacitance decrease the peak deviations and provide improved transient response for larger load current changes.

### PowerPath CONTROLLER

The PowerPath circuitry in the LTC3445 is used to provide backup power from  $V_{\text{BACKUP}}$  to the  $V_{\text{CC}}$  BATT pin when  $V_{\text{CC1}}$  is low or disconnected. When  $V_{\text{CC1}}$  is below 2.8V, the PowerPath routes  $V_{\text{BACKUP}}$ , typically a coin cell, to the  $V_{\text{CC}}$  BATT pin. While  $V_{\text{BACKUP}}$  is selected there is no current limiting except for a small ( $<5\Omega$ ) resistance from the  $V_{\text{BACKUP}}$  input to the  $V_{\text{CC}}$  BATT output. The LTC3445 sinks less than 6.5 $\mu\text{A}$  from  $V_{\text{BACKUP}}$  when it is selected and sinks less than 0.1 $\mu\text{A}$  from  $V_{\text{BACKUP}}$  when it is not selected.

When  $V_{\text{CC1}}$  exceeds 2.8V,  $V_{\text{BACKUP}}$  is disconnected from  $V_{\text{CC}}$  BATT and an internal LDO regulates the  $V_{\text{CC}}$  BATT voltage to the minimum of  $V_{\text{CC1}}$  or typically 3V. The internal LDO is current limited to less than 50mA, but greater than 10mA. Capacitance on the  $V_{\text{CC}}$  BATT pin should be at least 2 $\mu\text{F}$  with an ESR less than 3 $\Omega$ .

$V_{\text{BACKUP}}$  will be routed to the  $V_{\text{CC}}$  BATT output when the main battery voltage falls below 2.4V. As the main battery,  $V_{\text{CC1}}$ , voltage drops from 3V to 2.4V, the LDO will be in dropout,  $V_{\text{CC}}$  BATT will follow  $V_{\text{CC1}}$  down, rebounding to  $V_{\text{BACKUP}}$  when  $V_{\text{CC1}}$  falls below 2.4V. If  $V_{\text{CC1}}$  is removed quickly, the capacitor on  $V_{\text{CC}}$  BATT will limit the  $V_{\text{CC}}$  BATT droop until  $V_{\text{BACKUP}}$  is switched in.

The  $V_{\text{TRACK}}$  input offers the capability of the  $V_{\text{CC}}$  BATT voltage to follow the voltage on  $V_{\text{TRACK}}$  up to  $V_{\text{CC1}}$ . In effect,  $V_{\text{TRACK}}$  overrides the internal reference of the LDO, resulting in the LDO output ( $V_{\text{CC}}$  BATT) having a gain of 1 relative to  $V_{\text{TRACK}}$  once  $V_{\text{TRACK}}$  exceeds a typical value of 3V.  $V_{\text{CC}}$  BATT will follow  $V_{\text{TRACK}}$  to within 200mV providing  $V_{\text{TRACK}}$  does not exceed the dropout voltage of the LDO, which is powered by  $V_{\text{CC1}}$ .

$V_{\text{BACKUP}}$  should be present prior to  $V_{\text{CC1}}$  being connected.  $V_{\text{BACKUP}}$  provides power to the  $\text{BATTFAULT}$  driver which

is used to detect an absent or low  $V_{\text{CC1}}$ . If  $V_{\text{BACKUP}}$  is not present, the LTC3445 will be unable to pull the  $\text{BATTFAULT}$  pin low to signal a  $V_{\text{CC1}}$  fault condition.

### Output Capacitance and Transient Response

The LDO used LTC3445 PowerPath is designed to be stable with a wide range of output capacitors. A minimum output capacitor of 2.2 $\mu\text{F}$  with an ESR of 3 $\Omega$  or less is recommended to prevent oscillations. The LTC3445 PowerPath LDO is a micropower device and output transient response will be a function of output capacitance. Larger values of output capacitance decrease the peak deviations and provide improved transient response for larger load current changes.

### THERMAL CONSIDERATIONS

In most applications the LTC3445 does not dissipate much heat due to its high efficiency. But, in applications where the LTC3445 is running at high ambient temperature with low supply voltage and high duty cycles, such as in dropout, the heat dissipated may exceed the maximum junction temperature of the part. If the junction temperature reaches approximately 150 $^{\circ}\text{C}$ , both power switches will be turned off and the SW node will become high impedance. The remaining regulators will also turn off.

To ensure the LTC3445 doesn't exceed the maximum junction temperature, the user will need to do some thermal analysis. The goal of the thermal analysis is to determine whether the power dissipated exceeds the maximum junction temperature of the part. The temperature rise is given by:

$$T_R = \theta_{JA} \cdot (PD_{\text{BUCK}} + PD_{\text{LD01}} + PD_{\text{LD02}} + PD_{\text{PowerPath}})$$

where  $P_D$  is the power dissipated by the regulator and  $\theta_{JA}$  is the thermal resistance from the junction of the die to the ambient temperature.

The junction temperature,  $T_J$ , is given by:

$$T_J = T_A + T_R$$

where  $T_A$  is the ambient temperature.





# PACKAGE DESCRIPTION

## UF Package 24-Lead Plastic QFN (4mm × 4mm) (Reference LTC DWG # 05-08-1697)

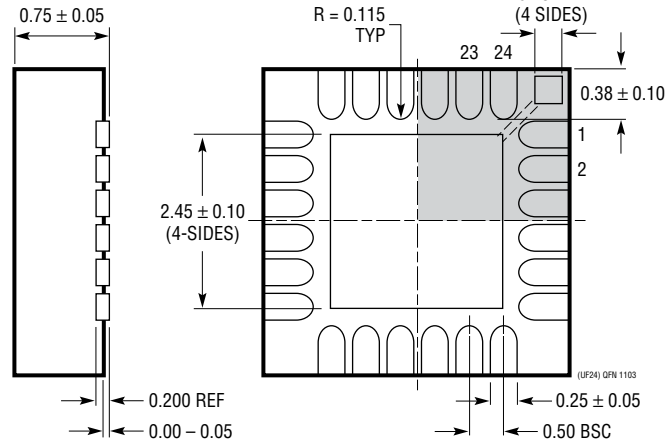
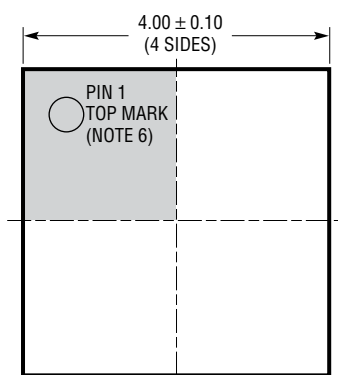
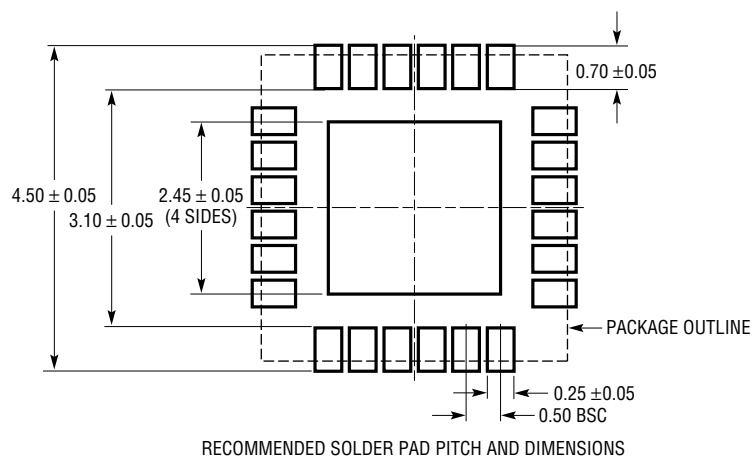

### NOTE:

1. DRAWING PROPOSED TO BE MADE A JEDEC PACKAGE OUTLINE MO-220 VARIATION (WGGD-X)—TO BE APPROVED
2. DRAWING NOT TO SCALE
3. ALL DIMENSIONS ARE IN MILLIMETERS
4. DIMENSIONS OF EXPOSED PAD ON BOTTOM OF PACKAGE DO NOT INCLUDE MOLD FLASH. MOLD FLASH, IF PRESENT, SHALL NOT EXCEED 0.15mm ON ANY SIDE, IF PRESENT
5. EXPOSED PAD SHALL BE SOLDER PLATED
6. SHADED AREA IS ONLY A REFERENCE FOR PIN 1 LOCATION ON THE TOP AND BOTTOM OF PACKAGE

## RELATED PARTS

PART NUMBER	DESCRIPTION	COMMENTS
LT1761	100mA, Low Noise Micropower, LDO	$V_{IN}$ : 1.8V to 20V, $V_{OUT(MIN)}$ = 1.22V, Dropout Voltage = 0.30V, $I_Q$ = 20 $\mu$ A, $I_{SD}$ < 1 $\mu$ A, $V_{OUT}$ = Adj, 1.5V, 1.8V, 2V, 2.5V, 2.8V, 3V, 3.3V, 5V, ThinSOT™ Package. Low Noise < 20 $\mu$ V <sub>RMS(P-P)</sub> , Stable with 1 $\mu$ F Ceramic Capacitors
LT1762	150mA, Low Noise Micropower, LDO	$V_{IN}$ : 1.8V to 20V, $V_{OUT(MIN)}$ = 1.22V, Dropout Voltage = 0.30V, $I_Q$ = 25 $\mu$ A, $I_{SD}$ < 1 $\mu$ A, $V_{OUT}$ = Adj, 2.5V, 3V, 3.3V, 5V, MS8 Package. Low Noise < 20 $\mu$ V <sub>RMS(P-P)</sub>
LT1763	500mA, Low Noise Micropower, LDO	$V_{IN}$ : 1.8V to 20V, $V_{OUT(MIN)}$ = 1.22V, Dropout Voltage = 0.30V, $I_Q$ = 30 $\mu$ A, $I_{SD}$ < 1 $\mu$ A, $V_{OUT}$ = 1.5V, 1.8V, 2.5V, 3V, 3.3V, 5V, S8 Package. Low Noise < 20 $\mu$ V <sub>RMS(P-P)</sub>
LTC1844	150mA, Very Low Dropout LDO	$V_{IN}$ : 6.5V to 1.6V, $V_{OUT(MIN)}$ = 1.25V, Dropout Voltage = 0.08V, $I_Q$ = 40 $\mu$ A, $I_{SD}$ < 1 $\mu$ A, $V_{OUT}$ = Adj, 1.5V, 1.8V, 2.5V, 2.8V, 3.3V, ThinSOT Package. Low Noise < 30 $\mu$ V <sub>RMS(P-P)</sub> , Stable with 1 $\mu$ F Ceramic Capacitors
LT1962	300mA, Low Noise Micropower, LDO	$V_{IN}$ : 1.8V to 20V, $V_{OUT(MIN)}$ = 1.22V, Dropout Voltage = 0.27V, $I_Q$ = 30 $\mu$ A, $I_{SD}$ < 1 $\mu$ A, $V_{OUT}$ = 1.5V, 1.8V, 2.5V, 3V, 3.3V, 5V, MS8 Package. Low Noise < 20 $\mu$ V <sub>RMS(P-P)</sub>
LT3020	Low $V_{IN}$ (0.9V) Low $V_{OUT}$ (0.2V) VLDO™	$V_{IN}$ : 0.9V to 10V, $V_{OUT(MIN)}$ = 0.20V, Dropout Voltage = 0.15V, $I_Q$ = 120 $\mu$ A, $I_{SD}$ < 1 $\mu$ A, $V_{OUT}$ = Adj, DFN Package
LTC3405/LTC3405A	300mA ( $I_{OUT}$ ), 1.5MHz Synchronous Step-Down DC/DC Converter	$V_{IN}$ : 2.5V to 5.5V, $V_{OUT(MIN)}$ = 0.8V, $I_Q$ = 20 $\mu$ A, $I_{SD}$ < 1 $\mu$ A, ThinSOT Package
LTC3406/LTC3406B	600mA ( $I_{OUT}$ ), 1.5MHz Synchronous Step-Down DC/DC Converter	$V_{IN}$ : 2.5V to 5.5V, $V_{OUT(MIN)}$ = 0.6V, $I_Q$ = 20 $\mu$ A, $I_{SD}$ < 1 $\mu$ A, ThinSOT Package
LTC3407	Dual 600mA, 1.5MHz Synchronous Step-Down DC/DC Converter	$V_{IN}$ : 2.5V to 5.5V, $V_{OUT(MIN)}$ = 0.6V, $I_Q$ = 40 $\mu$ A, $I_{SD}$ < 1 $\mu$ A, MS10E Package
LTC3411	1.25A ( $I_{OUT}$ ), 4MHz Synchronous Step-Down DC/DC Converter	$V_{IN}$ : 2.5V to 5.5V, $V_{OUT(MIN)}$ = 0.8V, $I_Q$ = 60 $\mu$ A, $I_{SD}$ < 1 $\mu$ A, MS10 Package
LTC3412	2.5A ( $I_{OUT}$ ), 4MHz Synchronous Step-Down DC/DC Converter	$V_{IN}$ : 2.5V to 5.5V, $V_{OUT(MIN)}$ = 0.8V, $I_Q$ = 60 $\mu$ A, $I_{SD}$ < 1 $\mu$ A, TSSOP16E Package
LTC3455	Dual DC/DC Converter with USB Power Manager and Li-Ion Battery Charger	$V_{IN}$ : 3V to 5.5V, Seamless Transition Between Input Sources and Li-Ion Battery, USB, 5V Wall Adapter, QFN24 Package
LTC4055	USB Power Manager and Li-Ion Battery Charger	Standalone Charger, Automatic Switchover when Input Supply is Removed
LTC4411/LTC4412	PowerPath Controllers in ThinSOT	More Efficient than Diode ORing

ThinSOT and VLDO are trademarks of Linear Technology Corporation.

## Looking for pricing, stock, or lifecycle information?

Click below to explore more details on WIN SOURCE:

 [View LTC3445EUF#PBF on WIN SOURCE](#)

 [Linear Technology](#) Information

## Optimize Your Supply Chain with WIN SOURCE Solutions

-  Global Sourcing Solution
-  Obsolete Management
-  Cost Control Management
-  Shortage Management
-  Alternative Solution
-  Excess Inventory Management