



**THE DATASHEET OF
LXES1TBAA2-013**



1. Application

- ESD Protection

2. Features

- IEC61000-4-2(ESD) $\pm 15\text{kV}$ (air), $\pm 12\text{kV}$ (contact)
- Low capacitance : 0.55pF typical
- Fast turn on and low clamping voltage
- For 2lines
- RoHS regulation conformity parts

3. Mechanical details (dimensions : mm)

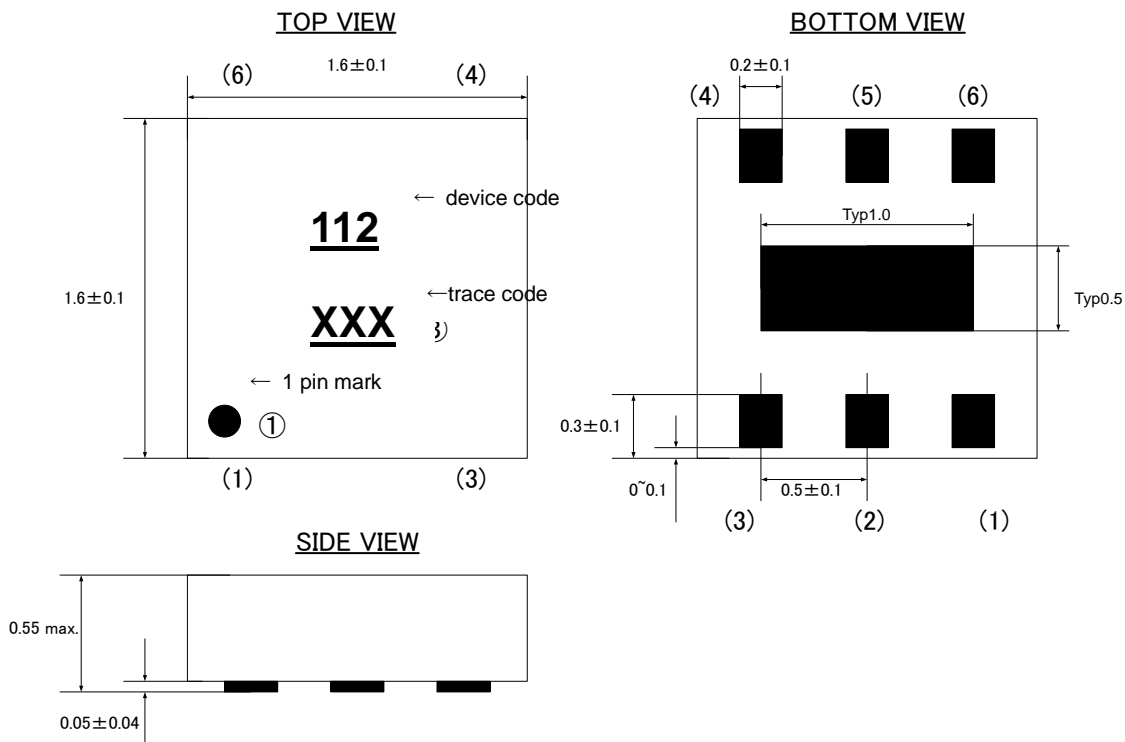

Pin configuration

No.	Terminal name
(1)	I/O 1
(2)	VDD
(3)	I/O 2
(4)	NC
(5)	GND
(6)	NC

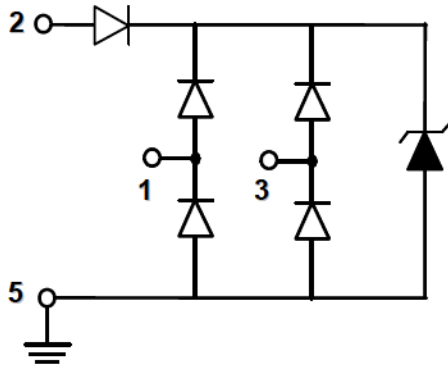
4. Schematic

5. Maximum Ratings

Rating	Symbol	Value	Units
Operating voltage(VDD-GND)	V_{DC}	5.5	V
ESD per IEC 61000-4-2 (air)	V_{ESD}	±15	kV
ESD per IEC 61000-4-2 (contact)		±12	
Lead Soldering Temperature	T_{SOL}	260(10sec.)	°C
Operating Temperature	T_{OP}	-40 to +85	°C
Storage Temperature	T_{STO}	-40 to +125	°C

6. Electrical characteristics (T=25 °C)

Parameter	Symbol	Conditions	Min	Typ	Max	Units
Leakage Current (I/O-GND)	I_{Leak}	$V_{pin5}=0V, V_{pin2}=5V, V_{CH}=0-5V$			1	μA
Breakdown Voltage	V_{BV}	$I_{BV} = 1mA$	6		9	V
Capacitance (I/O-GND)	C_{IN}	$V_{pin5} = 0V, V_{pin2} = 5V, V_{IN} = 2.5V, f = 1MHz$		0.55		pF

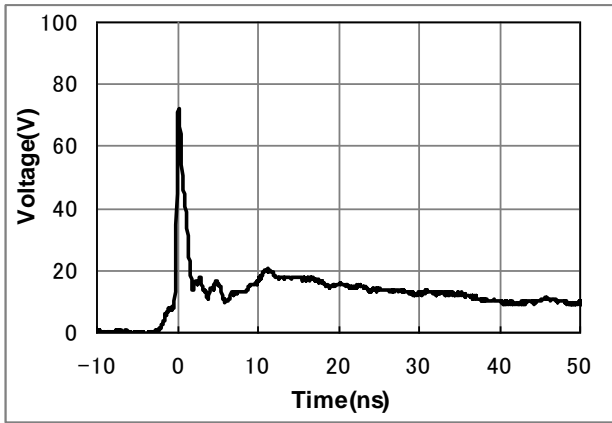
7. Typical Characteristic



ESD Waveform (IEC61000-4-2: 8kV Contact)

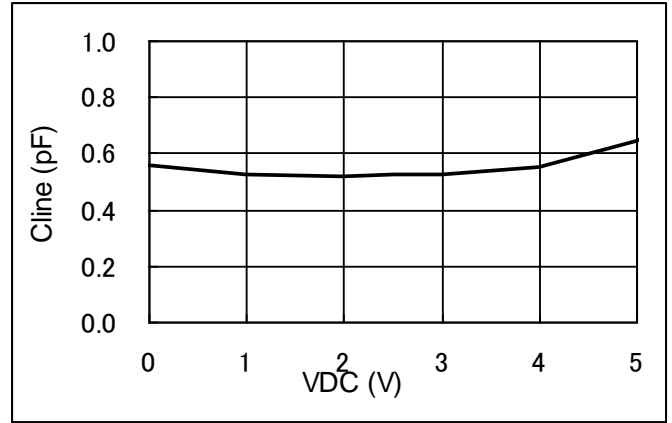

Voltage – Capacitance Characteristic

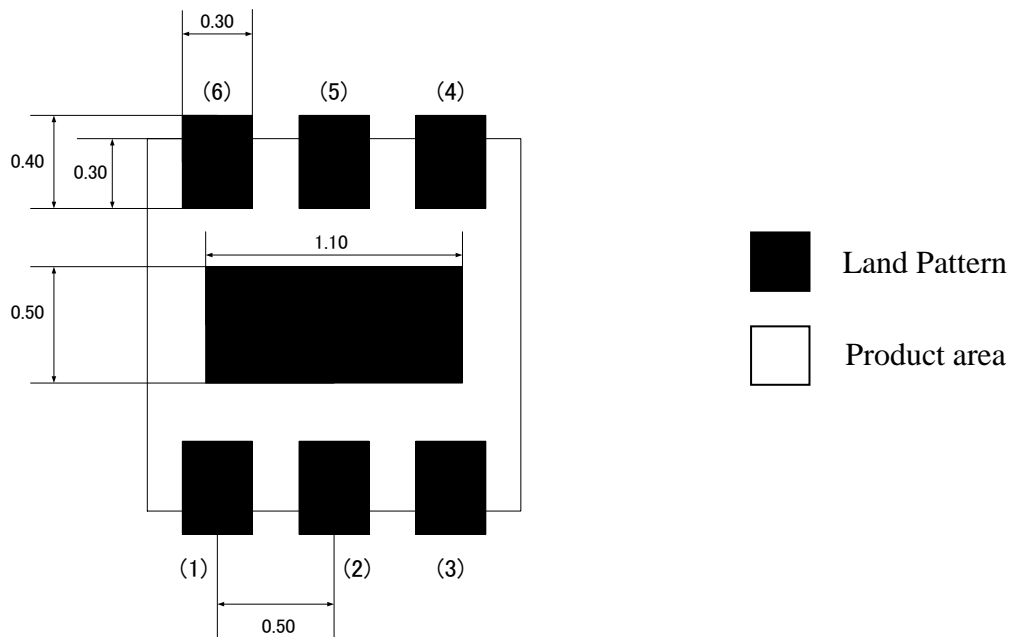

8. Soldering Footprint (dimensions : mm)



Notes : this land layout is for reference purpose only.

Looking for pricing, stock, or lifecycle information?

Click below to explore more details on WIN SOURCE:

-  [View LXES1TBAA2-013 on WIN SOURCE](#)
-  [Murata Electronics North America Information](#)

Optimize Your Supply Chain with WIN SOURCE Solutions

-  Global Sourcing Solution
-  Obsolete Management
-  Cost Control Management
-  Shortage Management
-  Alternative Solution
-  Excess Inventory Management