



**THE DATASHEET OF  
M24C64-FMB6TG**





# M24C64-DF M24C64-W M24C64-R M24C64-F

## 64 Kbit serial I<sup>2</sup>C bus EEPROM

### Features

- Compatible with all I<sup>2</sup>C bus modes:
  - 1 MHz Fast-mode Plus
  - 400 kHz Fast mode
  - 100 kHz Standard mode
- Memory array:
  - 64 Kb (8 Kbytes) of EEPROM
  - Page size: 32 bytes
  - Additional Write lockable Page (M24C64-DF)
- Write
  - Byte Write within 5 ms
  - Page Write within 5 ms
- Single supply voltage:
  - M24C64-W: 2.5 V to 5.5 V
  - M24C64-R: 1.8 V to 5.5 V
  - M24C64-xF: 1.7 V
- Random and Sequential Read modes
- Write protect of the whole memory array
- Enhanced ESD/Latch-Up protection
- More than 1 million Write cycles
- More than 40-year data retention
- Packages
  - RoHS-compliant and halogen-free (ECOPACK2®)
  - PDIP8 package: RoHS-compliant (ECOPACK1®)

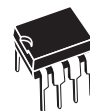

PDIP8 (BN)



SO8 (MN)  
150 mil width

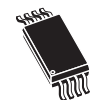

TSSOP8 (DW)  
169 mil width

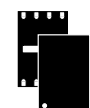

UFD8FN8 (MB)



WLCSP5 (CS)

# Contents

- 1 Description . . . . . 6**
- 2 Signal description . . . . . 8**
  - 2.1 Serial Clock (SCL) . . . . . 8
  - 2.2 Serial Data (SDA) . . . . . 8
  - 2.3 Chip Enable (E2, E1, E0) . . . . . 8
  - 2.4 Write Control ( $\overline{WC}$ ) . . . . . 8
  - 2.5  $V_{SS}$  ground . . . . . 9
  - 2.6 Supply voltage ( $V_{CC}$ ) . . . . . 9
    - 2.6.1 Operating supply voltage  $V_{CC}$  . . . . . 9
    - 2.6.2 Power-up conditions . . . . . 9
    - 2.6.3 Device reset . . . . . 9
    - 2.6.4 Power-down conditions . . . . . 9
- 3 Memory organization . . . . . 12**
- 4 Device operation . . . . . 13**
  - 4.1 Start condition . . . . . 13
  - 4.2 Stop condition . . . . . 13
  - 4.3 Acknowledge bit (ACK) . . . . . 13
  - 4.4 Data Input . . . . . 13
  - 4.5 Memory addressing . . . . . 14
  - 4.6 Write operations . . . . . 16
  - 4.7 Byte Write . . . . . 16
  - 4.8 Page Write . . . . . 16
  - 4.9 Write Identification Page (M24C64-D only) . . . . . 17
  - 4.10 Lock Identification Page (M24C64-D only) . . . . . 18
  - 4.11 ECC (Error Correction Code) and Write cycling . . . . . 18
  - 4.12 Minimizing system delays by polling on ACK . . . . . 19
  - 4.13 Read operations . . . . . 21
  - 4.14 Random Address Read . . . . . 21
  - 4.15 Current Address Read . . . . . 21



---

|           |   |           |
|-----------|---|-----------|
| 4.16      | Sequential Read . . . . .                     | 21        |
| 4.17      | Read Identification Page (M24C64-D) . . . . . | 21        |
| 4.18      | Read the lock status (M24C64-D) . . . . .     | 22        |
| 4.19      | Acknowledge in Read mode . . . . .            | 22        |
| <b>5</b>  | <b>Initial delivery state . . . . .</b>       | <b>23</b> |
| <b>6</b>  | <b>Maximum rating . . . . .</b>               | <b>23</b> |
| <b>7</b>  | <b>DC and AC parameters . . . . .</b>         | <b>24</b> |
| <b>8</b>  | <b>Package mechanical data . . . . .</b>      | <b>33</b> |
| <b>9</b>  | <b>Part numbering . . . . .</b>               | <b>38</b> |
| <b>10</b> | <b>Revision history . . . . .</b>             | <b>39</b> |

## List of tables

|           |  |    |
|-----------|--|----|
| Table 1.  | Signal names . . . . .   | 7  |
| Table 2.  | Device select code . . . . .   | 11 |
| Table 3.  | Address most significant byte . . . . .  | 11 |
| Table 4.  | Address least significant byte . . . . .   | 11 |
| Table 5.  | Operating modes . . . . .  | 14 |
| Table 6.  | Absolute maximum ratings . . . . .   | 23 |
| Table 7.  | Operating conditions (M24xxx-W) . . . . .  | 24 |
| Table 8.  | Operating conditions (M24xxx-R) . . . . .  | 24 |
| Table 9.  | Operating conditions (M24xxx-F) . . . . .  | 24 |
| Table 10. | AC test measurement conditions . . . . .   | 24 |
| Table 11. | Input parameters . . . . .   | 25 |
| Table 12. | Memory cell characteristics . . . . .  | 25 |
| Table 13. | DC characteristics (M24xxx-W, device grade 6) . . . . .  | 26 |
| Table 14. | DC characteristics (M24xxx-W - device grade 3) . . . . .   | 27 |
| Table 15. | DC characteristics (M24xxx-R - device grade 6) . . . . .   | 28 |
| Table 16. | DC characteristics (M24xxx-F) . . . . .  | 29 |
| Table 17. | 400 kHz AC characteristics . . . . .   | 30 |
| Table 18. | 1 MHz AC characteristics . . . . .   | 31 |
| Table 19. | PDIP8 – 8 pin plastic DIP, 0.25 mm lead frame, package mechanical data . . . . .                     | 33 |
| Table 20. | SO8 narrow – 8 lead plastic small outline, 150 mils body width,<br>package mechanical data . . . . . | 34 |
| Table 21. | TSSOP8 – 8 lead thin shrink small outline, package mechanical data . . . . .                         | 35 |
| Table 22. | UFDFPN8 (MLP8) 8-lead ultra thin fine pitch dual flat package no lead<br>2 x 3 mm, data . . . . .    | 36 |
| Table 23. | WLCSP-R 5-bump wafer-length chip-scale package mechanical data . . . . .                             | 37 |
| Table 24. | Ordering information scheme . . . . .  | 38 |
| Table 25. | Document revision history . . . . .  | 39 |

## List of figures

|            |  |    |
|------------|--|----|
| Figure 1.  | Logic diagram . . . . .  | 6  |
| Figure 2.  | 8-pin package connections . . . . .  | 7  |
| Figure 3.  | WLCSP connections (top view) . . . . .   | 7  |
| Figure 4.  | Device select code . . . . .   | 8  |
| Figure 5.  | I <sup>2</sup> C Fast mode ( $f_C = 400$ kHz): maximum $R_{BUS}$ value versus bus parasitic capacitance ( $C_{BUS}$ ) . . . . .    | 10 |
| Figure 6.  | I <sup>2</sup> C Fast mode Plus ( $f_C = 1$ MHz): maximum $R_{BUS}$ value versus bus parasitic capacitance ( $C_{BUS}$ ) . . . . . | 10 |
| Figure 7.  | I <sup>2</sup> C bus protocol . . . . .  | 11 |
| Figure 8.  | Block diagram . . . . .  | 12 |
| Figure 9.  | Write mode sequences with $\overline{WC} = 1$ (data write inhibited) . . . . .   | 15 |
| Figure 10. | Write mode sequences with $\overline{WC} = 0$ (data write enabled) . . . . .   | 17 |
| Figure 11. | Write cycle polling flowchart using ACK . . . . .  | 19 |
| Figure 12. | Read mode sequences . . . . .  | 20 |
| Figure 13. | AC test measurement I/O waveform . . . . .   | 24 |
| Figure 14. | AC waveforms . . . . .   | 32 |
| Figure 15. | PDIP8 – 8 pin plastic DIP, 0.25 mm lead frame, package outline . . . . .   | 33 |
| Figure 16. | SO8 narrow – 8 lead plastic small outline, 150 mils body width, package outline . . . . .  | 34 |
| Figure 17. | TSSOP8 – 8 lead thin shrink small outline, package outline . . . . .   | 35 |
| Figure 18. | UFDFPN8 (MLP8) – 8-lead ultra thin fine pitch dual flat package no lead 2 × 3mm, package outline . . . . .                         | 36 |
| Figure 19. | WLCSP-R 5-bump wafer-length chip-scale package outline . . . . .   | 37 |

# 1 Description

The M24C64-W operates with a supply voltage range of 2.5 V/5.5 V, the M24C64-R operates with a supply voltage range of 1.8 V/5.5 V and the M24C64-F, M24C64-DF devices operate with a supply voltage range of 1.7 V/5.5 V.

The M24C64-DF offers an additional page, named the Identification Page (32 bytes). The Identification Page can be used to store sensitive application parameters which can be (later) permanently locked in read only mode.

**Figure 1. Logic diagram**

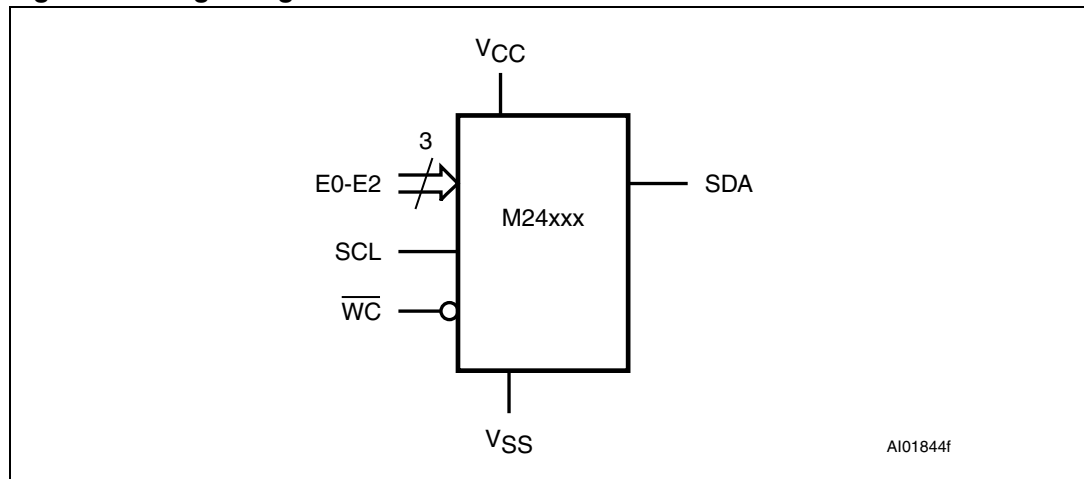

**Table 1. Signal names**

| Signal name     | Function       | Direction |
|-----------------|----------------|-----------|
| E2, E1, E0      | Chip Enable    | Input     |
| SDA             | Serial Data    | I/O       |
| SCL             | Serial Clock   | Input     |
| WC              | Write Control  | Input     |
| V <sub>CC</sub> | Supply voltage |           |
| V <sub>SS</sub> | Ground         |           |

**Figure 2. 8-pin package connections**

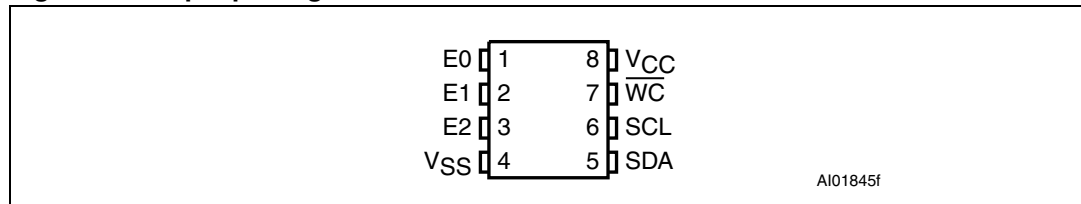

1. See [Package mechanical data](#) section for package dimensions, and how to identify pin-1.

**Figure 3. WLCSP connections (top view)**

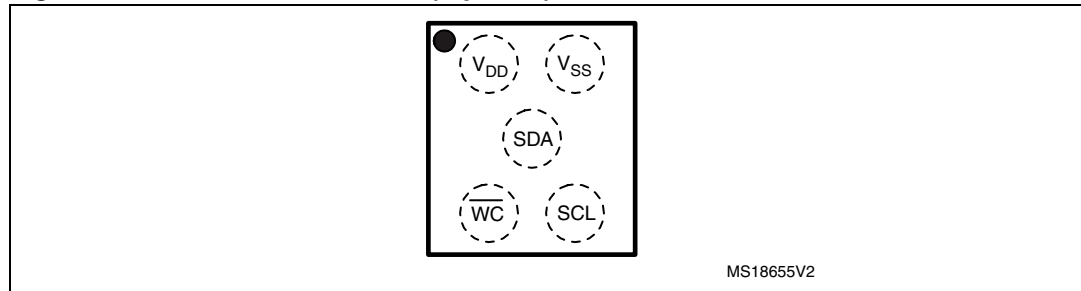

**Note:** Inputs E2, E1, E0 are internally connected to (001). Please refer to [Section 2.3](#) for further explanations.

**Caution:** As EEPROM cells lose their charge (and so their binary value) when exposed to ultra violet (UV) light, EEPROM dice delivered in wafer form or in WLCSP package by STMicroelectronics must never be exposed to UV light.

## 2 Signal description

### 2.1 Serial Clock (SCL)

This input signal is used to strobe all data in and out of the device. In applications where this signal is used by slave devices to synchronize the bus to a slower clock, the bus master must have an open drain output, and a pull-up resistor must be connected from Serial Clock (SCL) to  $V_{CC}$ . ([Figure 5](#) indicates how the value of the pull-up resistor can be calculated). In most applications, though, this method of synchronization is not employed, and so the pull-up resistor is not necessary, provided that the bus master has a push-pull (rather than open drain) output.

### 2.2 Serial Data (SDA)

This bidirectional signal is used to transfer data in or out of the device. It is an open drain output that may be wire-OR'ed with other open drain or open collector signals on the bus. A pull up resistor must be connected from Serial Data (SDA) to  $V_{CC}$ . ([Figure 5](#) indicates how the value of the pull-up resistor can be calculated).

### 2.3 Chip Enable (E2, E1, E0)

(E2,E1,E0) input signals are used to set the value that is to be looked for on the three least significant bits (b3, b2, b1) of the 7-bit device select code. These inputs must be tied to  $V_{CC}$  or  $V_{SS}$ , to establish the device select code as shown in [Figure 4](#). When not connected (left floating), these inputs are read as low (0). For the WLCSP package, the (E2,E1,E0) inputs are internally connected to (0,0,1).

**Figure 4. Device select code**

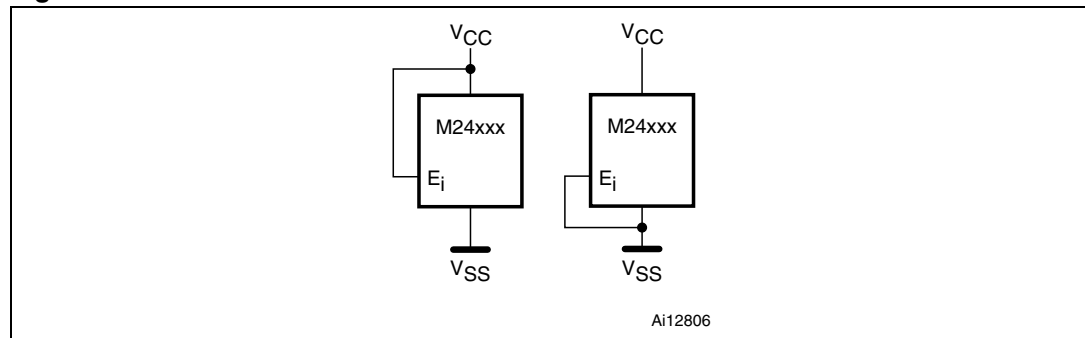

### 2.4 Write Control ( $\overline{WC}$ )

This input signal is useful for protecting the entire contents of the memory from inadvertent write operations. Write operations are disabled to the entire memory array when Write Control ( $\overline{WC}$ ) is driven high. When unconnected, the signal is internally read as  $V_{IL}$ , and Write operations are allowed.

When Write Control ( $\overline{WC}$ ) is driven high, device select and Address bytes are acknowledged, Data bytes are not acknowledged.

## 2.5 $V_{SS}$ ground

$V_{SS}$  is the reference for the  $V_{CC}$  supply voltage.

## 2.6 Supply voltage ( $V_{CC}$ )

### 2.6.1 Operating supply voltage $V_{CC}$

Prior to selecting the memory and issuing instructions to it, a valid and stable  $V_{CC}$  voltage within the specified [ $V_{CC}(\min)$ ,  $V_{CC}(\max)$ ] range must be applied (see [Table 7](#), [Table 8](#) and [Table 9](#)). In order to secure a stable DC supply voltage, it is recommended to decouple the  $V_{CC}$  line with a suitable capacitor (usually of the order of 10 nF to 100 nF) close to the  $V_{CC}/V_{SS}$  package pins.

This voltage must remain stable and valid until the end of the transmission of the instruction and, for a Write instruction, until the completion of the internal write cycle ( $t_W$ ).

### 2.6.2 Power-up conditions

The  $V_{CC}$  voltage has to rise continuously from 0 V up to the minimum  $V_{CC}$  operating voltage defined in [Table 7](#), [Table 8](#) and [Table 9](#). The rise time must not vary faster than 1 V/ $\mu$ s.

### 2.6.3 Device reset

In order to prevent inadvertent Write operations during power-up, a power on reset (POR) circuit is included. At power-up (continuous rise of  $V_{CC}$ ), the device does not respond to any instruction until  $V_{CC}$  has reached the power on reset threshold voltage (this threshold is lower than the minimum  $V_{CC}$  operating voltage defined in [Table 8](#) and [Table 9](#)). Until  $V_{CC}$  passes over the POR threshold, the device is reset and in Standby Power mode.

In a similar way, during power-down (continuous decay of  $V_{CC}$ ), as soon as  $V_{CC}$  drops below the POR threshold voltage, the device is reset and stops responding to any instruction sent to it.

### 2.6.4 Power-down conditions

During power-down (continuous decay of  $V_{CC}$ ), the device must be in Standby Power mode (mode reached after decoding a Stop condition, assuming that there is no internal Write cycle in progress).

**Figure 5. I<sup>2</sup>C Fast mode (f<sub>C</sub> = 400 kHz): maximum R<sub>bus</sub> value versus bus parasitic capacitance (C<sub>bus</sub>)**

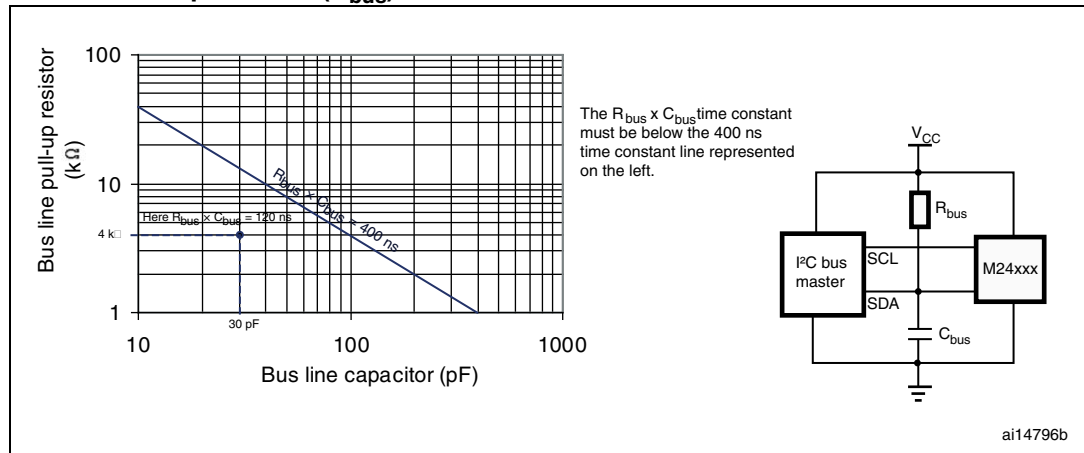

**Figure 6. I<sup>2</sup>C Fast mode Plus (f<sub>C</sub> = 1 MHz): maximum R<sub>bus</sub> value versus bus parasitic capacitance (C<sub>bus</sub>)**

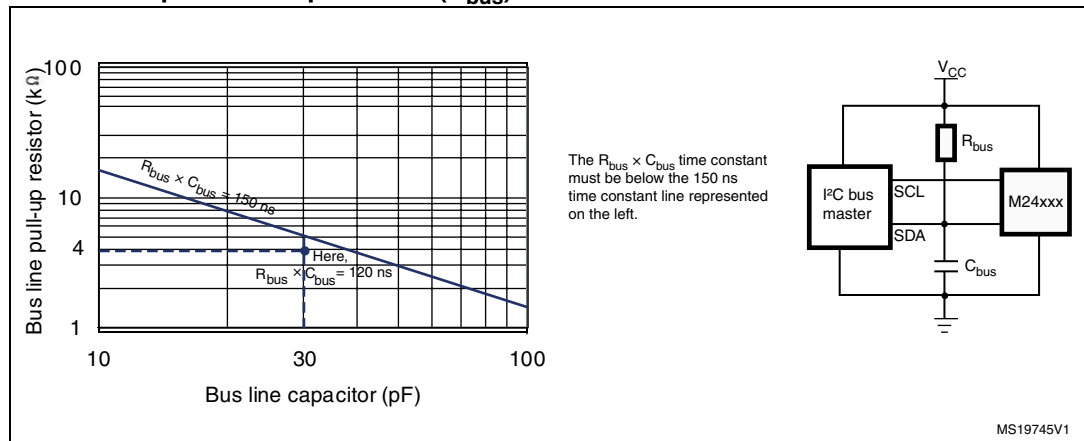

Figure 7. I<sup>2</sup>C bus protocol

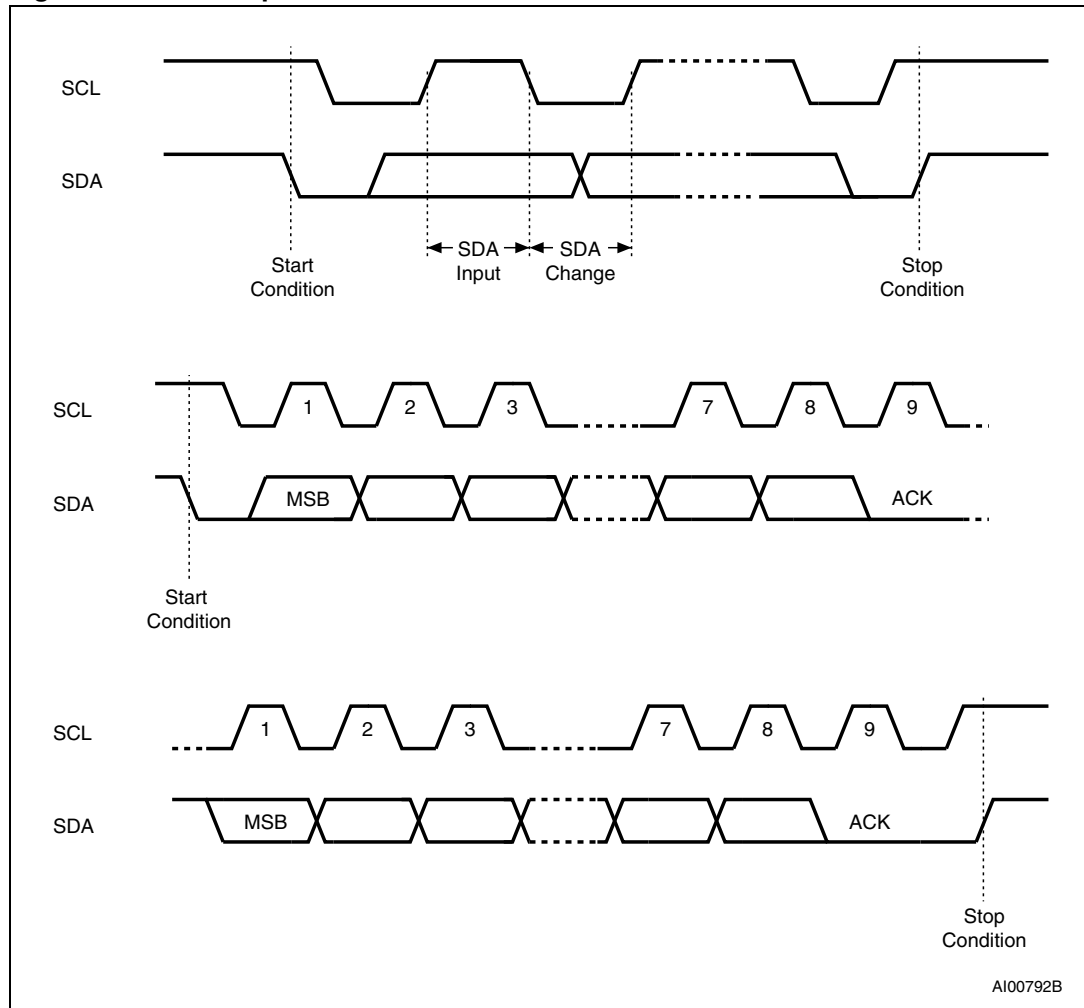

Table 2. Device select code

|                    | Device type identifier <sup>(1)</sup> |    |    |    | Chip Enable address <sup>(2)(3)</sup> |    |    | R $\bar{W}$ |
|--------------------|---------------------------------------|----|----|----|---------------------------------------|----|----|-------------|
|                    | b7                                    | b6 | b5 | b4 | b3                                    | b2 | b1 | b0          |
| Device select code | 1                                     | 0  | 1  | 0  | E2                                    | E1 | E0 | R $\bar{W}$ |

1. The most significant bit, b7, is sent first.
2. E2, E1 and E0 are compared against the respective external pins on the memory device.
3. For the WLCSP package, the (E2,E1,E0) inputs are internally connected to (0,0,1).

Table 3. Address most significant byte

|     |     |     |     |     |     |    |    |
|-----|-----|-----|-----|-----|-----|----|----|
| b15 | b14 | b13 | b12 | b11 | b10 | b9 | b8 |
|-----|-----|-----|-----|-----|-----|----|----|

Table 4. Address least significant byte

|    |    |    |    |    |    |    |    |
|----|----|----|----|----|----|----|----|
| b7 | b6 | b5 | b4 | b3 | b2 | b1 | b0 |
|----|----|----|----|----|----|----|----|

### 3 Memory organization

The memory is organized as shown in *Figure 8*.

**Figure 8. Block diagram**

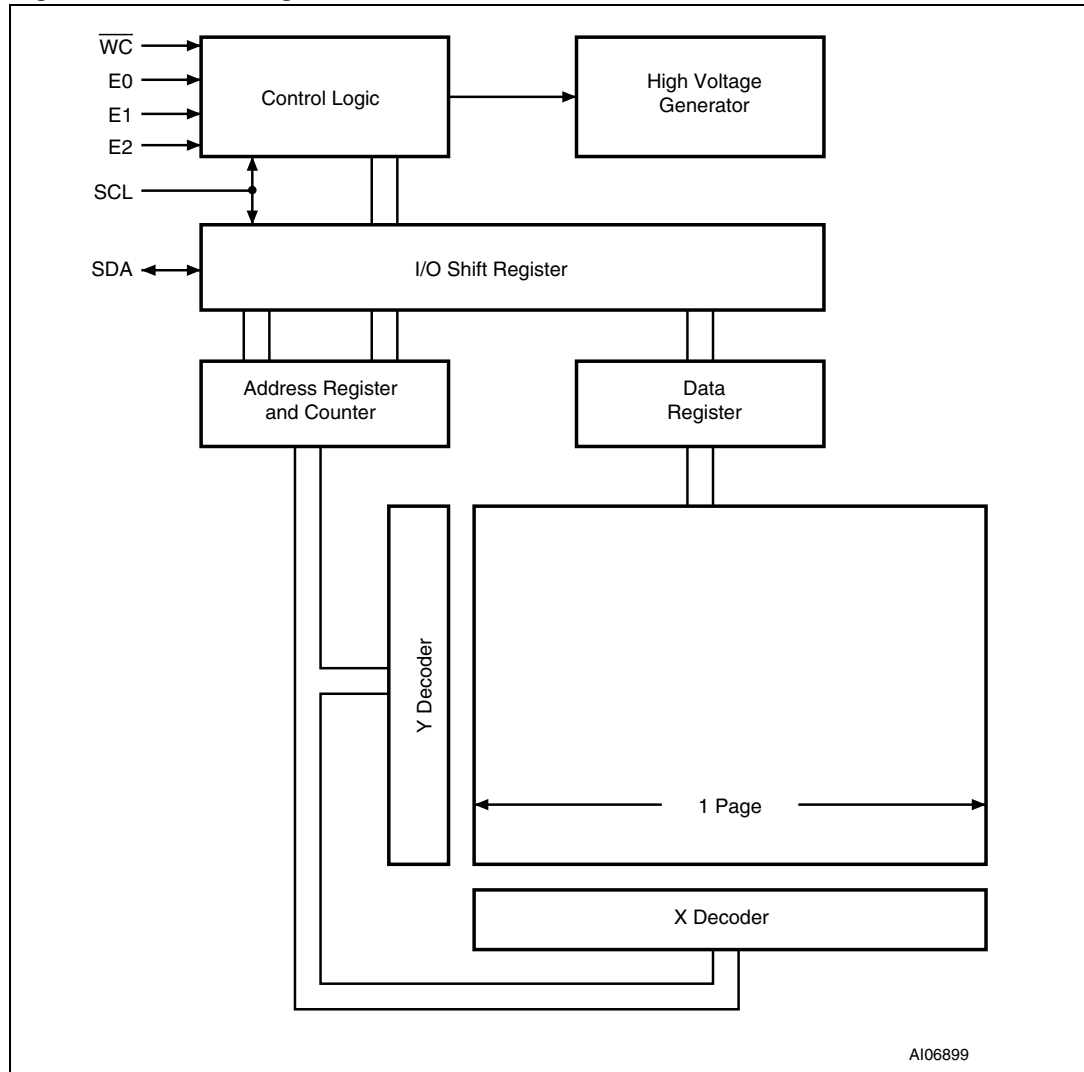

## 4 Device operation

The device supports the I<sup>2</sup>C protocol. This is summarized in [Figure 7](#). Any device that sends data on to the bus is defined to be a transmitter, and any device that reads the data to be a receiver. The device that controls the data transfer is known as the bus master, and the other as the slave device. A data transfer can only be initiated by the bus master, which will also provide the serial clock for synchronization. The device is always a slave in all communications.

### 4.1 Start condition

Start is identified by a falling edge of Serial Data (SDA) while Serial Clock (SCL) is stable in the high state. A Start condition must precede any data transfer command. The device continuously monitors (except during a Write cycle) Serial Data (SDA) and Serial Clock (SCL) for a Start condition.

### 4.2 Stop condition

Stop is identified by a rising edge of Serial Data (SDA) while Serial Clock (SCL) is stable and driven high. A Stop condition terminates communication between the device and the bus master. A Read command that is followed by NoAck can be followed by a Stop condition to force the device into the Standby mode. A Stop condition at the end of a Write command triggers the internal Write cycle.

### 4.3 Acknowledge bit (ACK)

The acknowledge bit is used to indicate a successful byte transfer. The bus transmitter, whether it be bus master or slave device, releases Serial Data (SDA) after sending eight bits of data. During the 9<sup>th</sup> clock pulse period, the receiver pulls Serial Data (SDA) low to acknowledge the receipt of the eight data bits.

### 4.4 Data Input

During data input, the device samples Serial Data (SDA) on the rising edge of Serial Clock (SCL). For correct device operation, Serial Data (SDA) must be stable during the rising edge of Serial Clock (SCL), and the Serial Data (SDA) signal must change *only* when Serial Clock (SCL) is driven low.

## 4.5 Memory addressing

To start communication between the bus master and the slave device, the bus master must initiate a Start condition. Following this, the bus master sends the device select code, shown in [Table 3](#) (on Serial Data (SDA), most significant bit first).

The device select code consists of a 4-bit device type identifier, and a 3-bit Chip Enable "Address" (E2, E1, E0). To address the memory array, the 4-bit device type identifier is 1010b. Up to eight memory devices can be connected on a single I<sup>2</sup>C bus<sup>(a)</sup>. Each one is given a unique 3-bit code on the Chip Enable (E2, E1, E0) inputs. When the device select code is received, the device only responds if the Chip Enable Address is the same as the value on the Chip Enable (E2, E1, E0) inputs.

The 8<sup>th</sup> bit is the Read/Write bit ( $\overline{RW}$ ). This bit is set to 1 for Read and 0 for Write operations.

If a match occurs on the device select code, the corresponding device gives an acknowledgment on Serial Data (SDA) during the 9<sup>th</sup> bit time. If the device does not match the device select code, it deselects itself from the bus, and goes into Standby mode.

**Table 5. Operating modes**

| Mode                 | $\overline{RW}$ bit | $\overline{WC}^{(1)}$ | Bytes     | Initial sequence                                    |
|----------------------|---------------------|-----------------------|-----------|---|
| Current Address Read | 1                   | X                     | 1         | Start, device select, $\overline{RW} = 1$           |
| Random Address Read  | 0                   | X                     | 1         | Start, device select, $\overline{RW} = 0$ , Address |
|                      | 1                   | X                     |           | reStart, device select, $\overline{RW} = 1$         |
| Sequential Read      | 1                   | X                     | $\geq 1$  | Similar to Current or Random Address Read           |
| Byte Write           | 0                   | $V_{IL}$              | 1         | Start, device select, $\overline{RW} = 0$           |
| Page Write           | 0                   | $V_{IL}$              | $\leq 32$ | Start, device select, $\overline{RW} = 0$           |

1. X =  $V_{IH}$  or  $V_{IL}$ .

a. Only one M24C64 in WLCSP package can be connected on the I<sup>2</sup>C bus (see [Figure 4](#)).

Figure 9. Write mode sequences with  $\overline{WC} = 1$  (data write inhibited)

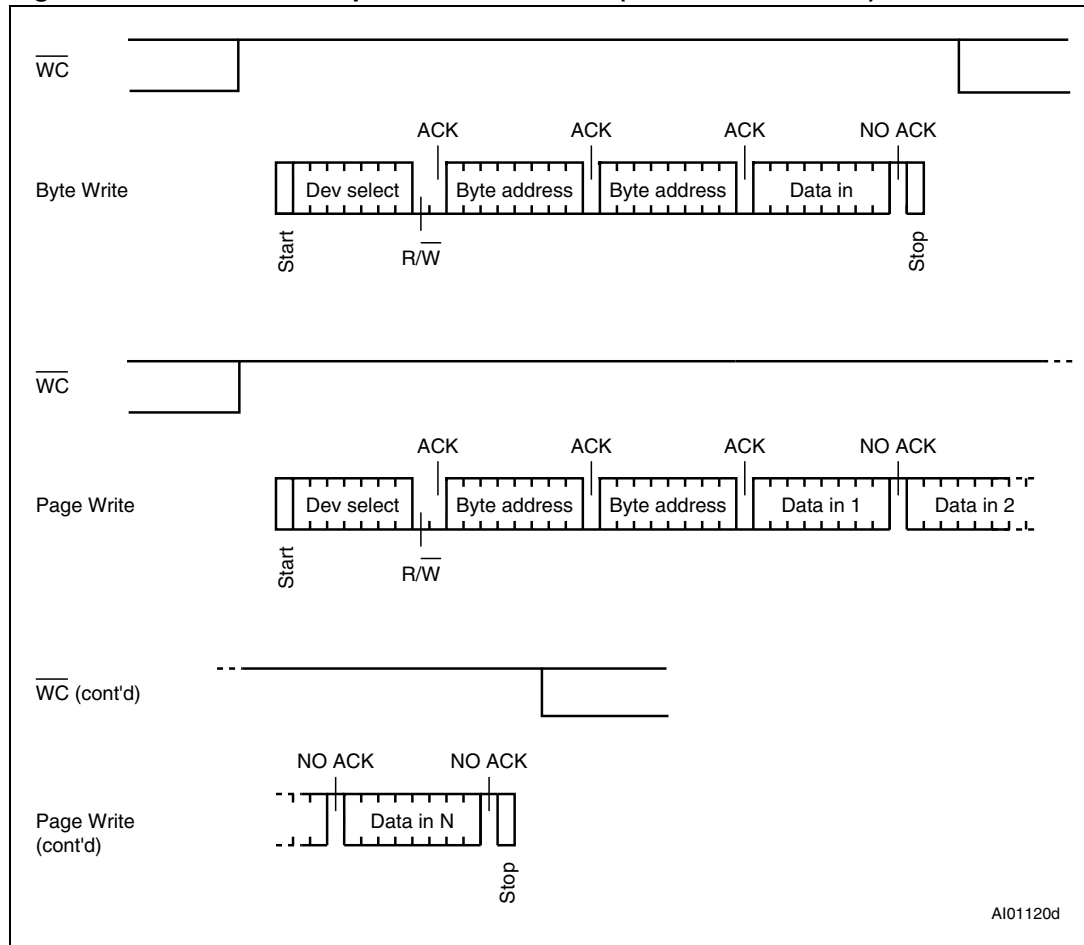

AI01120d

## 4.6 Write operations

Following a Start condition the bus master sends a device select code with the Read/Write bit ( $\overline{RW}$ ) reset to 0. The device acknowledges this, as shown in [Figure 10](#), and waits for two address bytes. The device responds to each address byte with an acknowledge bit, and then waits for the data Byte.

Each data byte in the memory has a 16-bit (two byte wide) address. The Most Significant Byte ([Table 3](#)) is sent first, followed by the Least Significant Byte ([Table 4](#)). Bits b15 to b0 form the address of the byte in memory.

When the bus master generates a Stop condition immediately after a data byte Ack bit (in the “10<sup>th</sup> bit” time slot), either at the end of a Byte Write or a Page Write, the internal Write cycle is triggered. A Stop condition at any other time slot does not trigger the internal Write cycle.

After the Stop condition, the delay  $t_w$ , and the successful completion of a Write operation, the device's internal address counter is incremented automatically, to point to the next byte address after the last one that was modified.

During the internal Write cycle, Serial Data (SDA) is disabled internally, and the device does not respond to any requests.

If the Write Control input (WC) is driven High, the Write instruction is not executed and the accompanying data bytes are not acknowledged, as shown in [Figure 9](#).

## 4.7 Byte Write

After the device select code and the address bytes, the bus master sends one data byte. If the addressed location is Write-protected, by Write Control ( $\overline{WC}$ ) being driven high, the device replies with NoAck, and the location is not modified. If, instead, the addressed location is not Write-protected, the device replies with Ack. The bus master terminates the transfer by generating a Stop condition, as shown in [Figure 10](#).

## 4.8 Page Write

The Page Write mode allows up to 32 bytes to be written in a single Write cycle, provided that they are all located in the same ‘row’ in the memory: that is, the most significant memory address bits (b12-b5) are the same. If more bytes are sent than will fit up to the end of the row, a condition known as ‘roll-over’ occurs. This should be avoided, as data starts to become overwritten in an implementation dependent way.

The bus master sends from 1 to 32 bytes of data, each of which is acknowledged by the device if Write Control ( $\overline{WC}$ ) is low. If Write Control ( $\overline{WC}$ ) is high, the contents of the addressed memory location are not modified, and each data byte is followed by a NoAck. After each byte is transferred, the internal byte address counter (inside the page) is incremented. The transfer is terminated by the bus master generating a Stop condition.

Figure 10. Write mode sequences with  $\overline{WC} = 0$  (data write enabled)

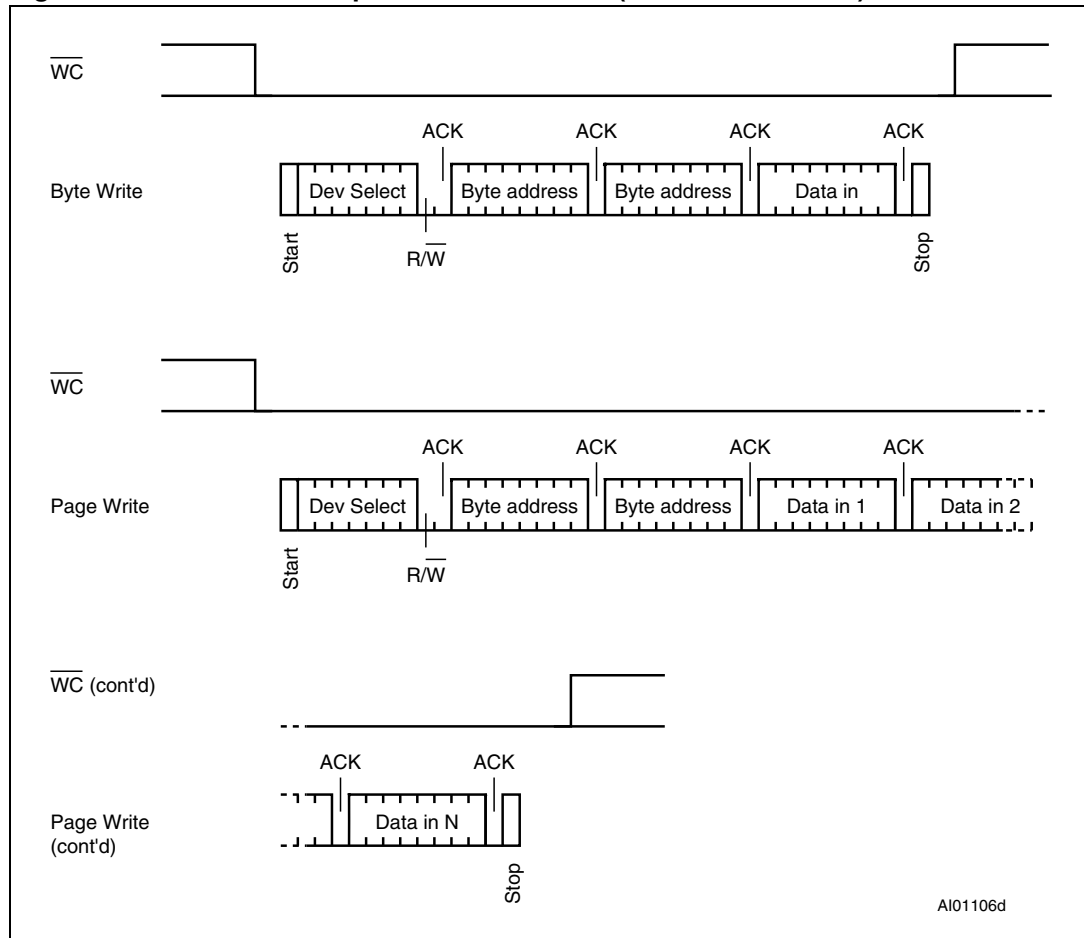

## 4.9 Write Identification Page (M24C64-D only)

The Identification Page (32 bytes) is an additional page which can be written and (later) permanently locked in Read-only mode. The Identification Page is written by issuing an Write Identification Page instruction. This instruction uses the same protocol and format as Page Write (into memory array), except for the following differences:

- Device type identifier = 1011b
- MSB address bits A15/A5 are don't care except for address bit A10 which must be '0'.

LSB address bits A4/A0 define the byte address inside the Identification Page.

If the Identification Page is locked, the data bytes transferred during the Write Identification Page instruction are not acknowledged (NoAck).

## 4.10 Lock Identification Page (M24C64-D only)

The Lock Identification Page instruction (Lock ID) permanently locks the Identification Page in Read-only mode. The Lock ID instruction is similar to Byte Write (into memory array) with the following specific conditions:

- Device type identifier = 1011b
- Address bit A10 must be '1'; all other address bits are don't care
- The data byte must be equal to the binary value xxxx xx1x, where x is don't care

If the Identification Page is locked, the data bytes transferred during the Lock Identification Page instruction are not acknowledged (NoAck).

## 4.11 ECC (Error Correction Code) and Write cycling

The M24C64 devices identified with the process letter A or K offer an ECC (Error Correction Code) logic which compares each 4-byte word with its associated 6 EEPROM bits of ECC. As a result, if a single bit out of 4 bytes of data happens to be erroneous during a Read operation, the ECC detects it and replaces it by the correct value. The read reliability is therefore much improved by the use of this feature.

Note however that even if a single byte has to be written, 4 bytes are internally modified (plus the ECC bits), that is, the addressed byte is cycled together with the three other bytes making up the word. It is therefore recommended to write by word (4 bytes) at address  $4*N$  (where N is an integer) in order to benefit from the larger amount of Write cycles.

The M24C64 devices are qualified as 1 million (1,000,000) Write cycles, using a cycling routine that writes to the device by multiples of 4-byte words.

Figure 11. Write cycle polling flowchart using ACK

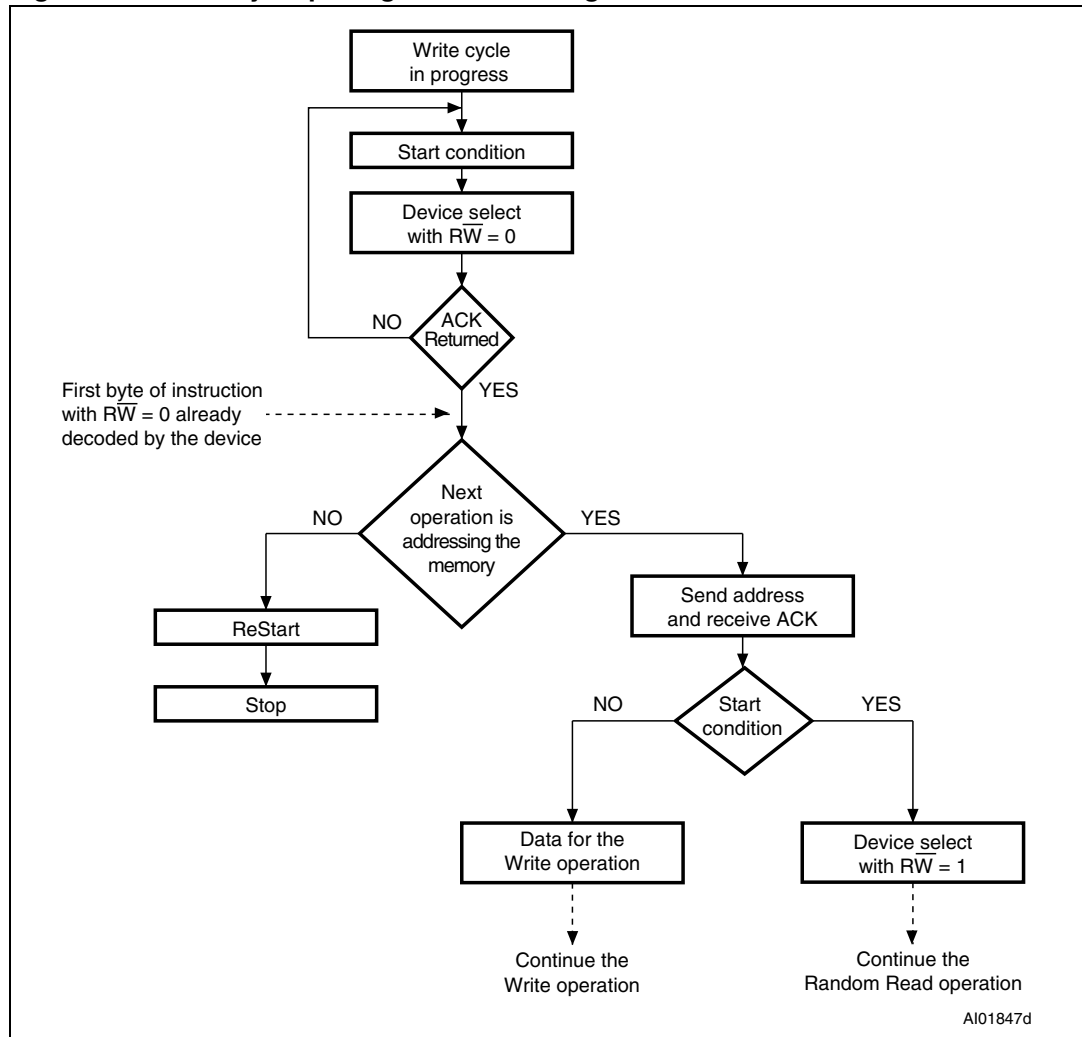

## 4.12 Minimizing system delays by polling on ACK

During the internal Write cycle, the device disconnects itself from the bus, and writes a copy of the data from its internal latches to the memory cells. The maximum Write time ( $t_w$ ) is shown in [Table 17](#), but the typical time is shorter. To make use of this, a polling sequence can be used by the bus master.

The sequence, as shown in [Figure 11](#), is:

1. Initial condition: a Write cycle is in progress.
2. Step 1: the bus master issues a Start condition followed by a device select code (the first byte of the new instruction).
3. Step 2: if the device is busy with the internal Write cycle, no Ack will be returned and the bus master goes back to Step 1. If the device has terminated the internal Write cycle, it responds with an Ack, indicating that the device is ready to receive the second part of the instruction (the first byte of this instruction having been sent during Step 1).

Figure 12. Read mode sequences

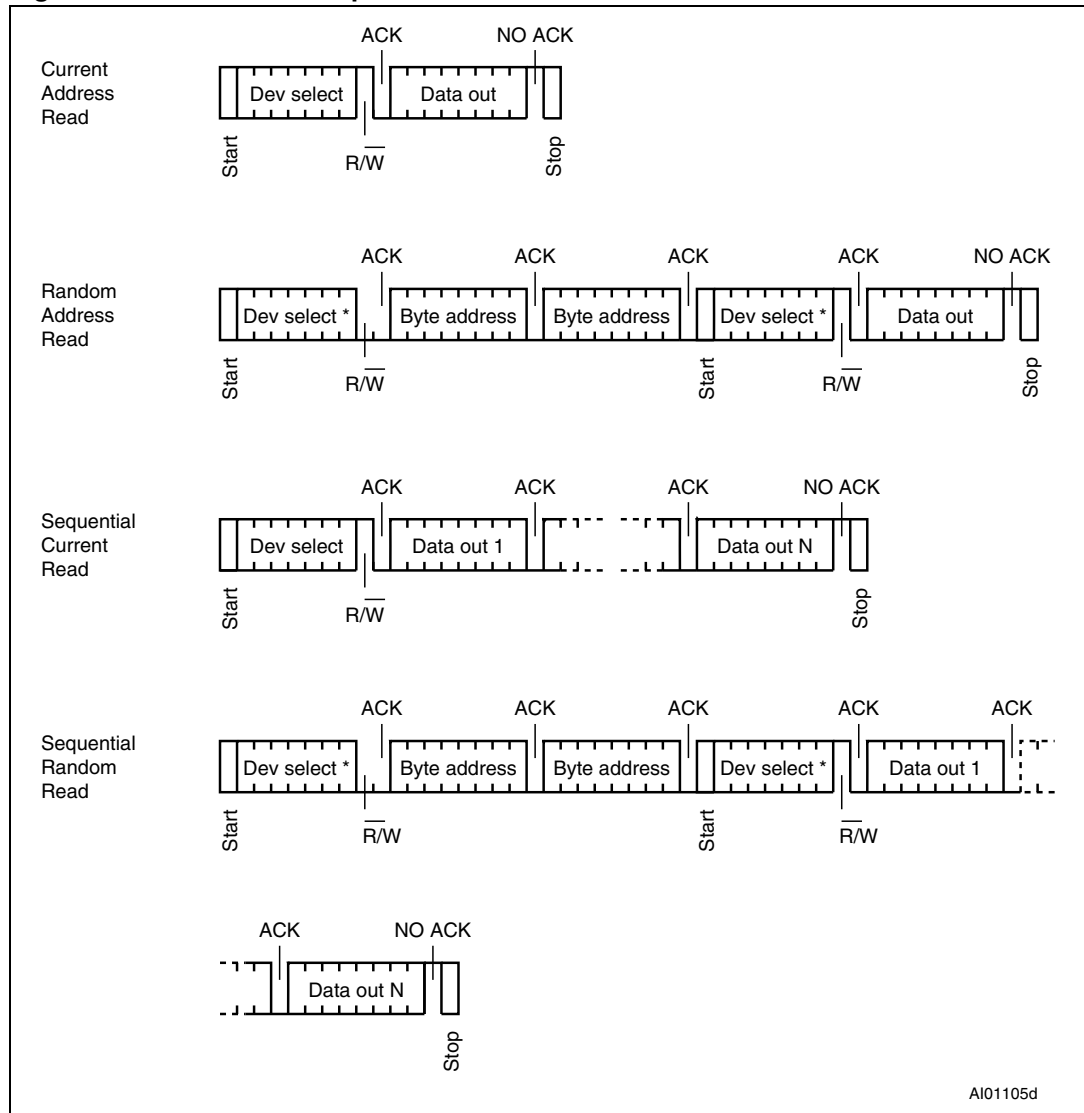

1. The seven most significant bits of the device select code of a Random Read (in the 1<sup>st</sup> and 4<sup>th</sup> bytes) must be identical.

## 4.13 Read operations

Read operations are performed independently of the state of the Write Control ( $\overline{WC}$ ) signal. After the successful completion of a Read operation, the device's internal address counter is incremented by one, to point to the next byte address.

## 4.14 Random Address Read

A dummy Write is first performed to load the address into this address counter (as shown in [Figure 12](#)) but *without* sending a Stop condition. Then, the bus master sends another Start condition, and repeats the device select code, with the Read/Write bit ( $\overline{RW}$ ) set to 1. The device acknowledges this, and outputs the contents of the addressed byte. The bus master must *not* acknowledge the byte, and terminates the transfer with a Stop condition.

## 4.15 Current Address Read

For the Current Address Read operation, following a Start condition, the bus master only sends a device select code with the Read/Write bit ( $\overline{RW}$ ) set to 1. The device acknowledges this, and outputs the byte addressed by the internal address counter. The counter is then incremented. The bus master terminates the transfer with a Stop condition, as shown in [Figure 12](#), *without* acknowledging the Byte.

## 4.16 Sequential Read

This operation can be used after a Current Address Read or a Random Address Read. The bus master *does* acknowledge the data byte output, and sends additional clock pulses so that the device continues to output the next byte in sequence. To terminate the stream of bytes, the bus master must *not* acknowledge the last byte, and *must* generate a Stop condition, as shown in [Figure 12](#).

The output data comes from consecutive addresses, with the internal address counter automatically incremented after each byte output. After the last memory address, the address counter 'rolls-over', and the device continues to output data from memory address 00h.

## 4.17 Read Identification Page (M24C64-D)

The Identification Page (32 bytes) is an additional page which can be written and (later) permanently locked in Read-only mode.

The Identification Page can be read by issuing an Read Identification Page instruction. This instruction uses the same protocol and format as the Random Address Read (from memory array) with device type identifier defined as 1011b. The MSB address bits A15/A5 are don't care, the LSB address bits A4/A0 define the byte address inside the Identification Page. The number of bytes to read in the ID page must not exceed the page boundary, otherwise unexpected data is read (e.g.: when reading the Identification Page from location 10d, the number of bytes should be less than or equal to 22, as the ID page boundary is 32 bytes).

## 4.18 Read the lock status (M24C64-D)

The locked/unlocked status of the Identification page can be checked by transmitting a specific truncated command [Identification Page Write instruction + one data byte] to the device. The device returns an acknowledge bit if the Identification page is unlocked, otherwise a NoAck bit if the Identification page is locked.

Right after this, it is recommended to transmit to the device a Start condition followed by a Stop condition, so that:

- Start: the truncated command is not executed because the Start condition resets the device internal logic,
- Stop: the device is then set back into Standby mode by the Stop condition.

## 4.19 Acknowledge in Read mode

For all Read commands, the device waits, after each byte read, for an acknowledgment during the 9<sup>th</sup> bit time. If the bus master does not drive Serial Data (SDA) low during this time, the device terminates the data transfer and switches to its Standby mode.

## 5 Initial delivery state

The device is delivered with all bits in the memory array set to 1 (each byte contains FFh).

## 6 Maximum rating

Stressing the device outside the ratings listed in [Table 6](#) may cause permanent damage to the device. These are stress ratings only, and operation of the device at these, or any other conditions outside those indicated in the Operating sections of this specification, is not implied. Exposure to absolute maximum rating conditions for extended periods may affect device reliability. Refer also to the STMicroelectronics SURE Program and other relevant quality documents.

**Table 6. Absolute maximum ratings**

| Symbol     | Parameter   | Min.                    | Max.               | Unit |
|------------|---|-------------------------|--------------------|------|
| $T_A$      | Ambient operating temperature                         | -40                     | 130                | °C   |
| $T_{STG}$  | Storage temperature                                   | -65                     | 150                | °C   |
| $T_{LEAD}$ | Lead temperature during soldering                     | see note <sup>(1)</sup> |                    | °C   |
|            | PDIP-specific lead temperature during soldering       |                         | 260 <sup>(2)</sup> | °C   |
| $V_{IO}$   | Input or output range                                 | -0.50                   | 6.5                | V    |
| $I_{OL}$   | DC output current (SDA = 0)                           | -                       | 5                  | mA   |
| $V_{CC}$   | Supply voltage  | -0.50                   | 6.5                | V    |
| $V_{ESD}$  | Electrostatic pulse (human body model) <sup>(3)</sup> | -                       | 4000               | V    |

1. Compliant with JEDEC Std J-STD-020D (for small body, Sn-Pb or Pb assembly), the ST ECOPACK® 7191395 specification, and the European directive on Restrictions on Hazardous Substances (RoHS) 2002/95/EU.
2.  $T_{LEAD}$  max must not be applied for more than 10 s.
3. Positive and negative pulses applied on pin pairs, according to the AEC-Q100-002 (compliant with JEDEC Std JESD22-A114, C1=100pF, R1=1500Ω, R2=500Ω)

# 7 DC and AC parameters

**Table 7. Operating conditions (M24xxx-W)**

| Symbol   | Parameter                                      | Min. | Max. | Unit |
|----------|--|------|------|------|
| $V_{CC}$ | Supply voltage                                 | 2.5  | 5.5  | V    |
| $T_A$    | Ambient operating temperature (device grade 6) | -40  | 85   | °C   |
|          | Ambient operating temperature (device grade 3) | -40  | 125  | °C   |
| $f_C$    | Operating clock frequency                      | -    | 1    | MHz  |

**Table 8. Operating conditions (M24xxx-R)**

| Symbol   | Parameter                     | Min. | Max. | Unit |
|----------|-------------------------------|------|------|------|
| $V_{CC}$ | Supply voltage                | 1.8  | 5.5  | V    |
| $T_A$    | Ambient operating temperature | -40  | 85   | °C   |
| $f_C$    | Operating clock frequency     | -    | 1    | MHz  |

**Table 9. Operating conditions (M24xxx-F)**

| Symbol   | Parameter                     | Min. | Max.               | Unit |
|----------|-------------------------------|------|--------------------|------|
| $V_{CC}$ | Supply voltage                | 1.7  | 5.5                | V    |
| $T_A$    | Ambient operating temperature | -40  | 85                 | °C   |
| $f_C$    | Operating clock frequency     | -    | 400 <sup>(1)</sup> | kHz  |

1.  $f_{Cmax}$  is 1 MHz under certain conditions, see [Table 16](#), note 1.

**Table 10. AC test measurement conditions**

| Symbol    | Parameter                                     | Min.                         | Max. | Unit |
|-----------|---|------------------------------|------|------|
| $C_{bus}$ | Load capacitance                              | 100                          |      | pF   |
|           | SCL input rise/fall time, SDA input fall time |                              | 50   | ns   |
|           | Input voltage levels                          | 0.2 $V_{CC}$ to 0.8 $V_{CC}$ |      | V    |
|           | Input and output timing reference levels      | 0.3 $V_{CC}$ to 0.7 $V_{CC}$ |      | V    |

**Figure 13. AC test measurement I/O waveform**

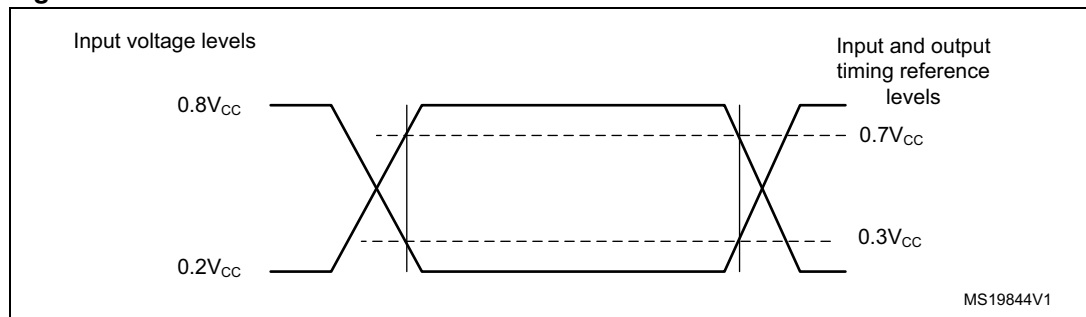

**Table 11. Input parameters**

| Symbol      | Parameter <sup>(1)</sup>         | Test condition       | Min. | Max. | Unit       |
|-------------|----------------------------------|----------------------|------|------|------------|
| $C_{IN}$    | Input capacitance (SDA)          |                      |      | 8    | pF         |
| $C_{IN}$    | Input capacitance (other pins)   |                      |      | 6    | pF         |
| $Z_L^{(2)}$ | Input impedance (E2, E1, E0, WC) | $V_{IN} < 0.3V_{CC}$ | 30   |      | k $\Omega$ |
| $Z_H^{(2)}$ | Input impedance (E2, E1, E0, WC) | $V_{IN} > 0.7V_{CC}$ | 500  |      | k $\Omega$ |

1. Characterized value, not tested in production.

2. E2,E1,E0: Input impedance when the memory is selected (after a Start condition).

**Table 12. Memory cell characteristics**

| Symbol      | Parameter | Test condition                             | Min.      | Max. | Unit        |
|-------------|-----------|--|-----------|------|-------------|
| $N_{cycle}$ | Endurance | $TA = 25^{\circ}C, 1.8 V < V_{CC} < 5.5 V$ | 1,000,000 | -    | Write cycle |

*Note: This parameter is not tested but established by characterization and qualification. For endurance estimates in a specific application, please refer to AN2014.*

Table 13. DC characteristics (M24xxx-W, device grade 6)

| Symbol    | Parameter                                    | Test conditions (see <a href="#">Table 7</a> and <a href="#">Table 10</a> )           | Min.        | Max.         | Unit    |
|-----------|--|---|-------------|--------------|---------|
| $I_{LI}$  | Input leakage current (SCL, SDA, E2, E1, E0) | $V_{IN} = V_{SS}$ or $V_{CC}$<br>device in Standby mode                               |             | $\pm 2$      | $\mu A$ |
| $I_{LO}$  | Output leakage current                       | SDA in Hi-Z, external voltage applied on SDA: $V_{SS}$ or $V_{CC}$                    |             | $\pm 2$      | $\mu A$ |
| $I_{CC}$  | Supply current (Read)                        | $2.5 V < V_{CC} < 5.5 V$ , $f_c = 400 kHz$<br>(rise/fall time $< 50 ns$ )             |             | 2            | mA      |
|           |  | $2.5 V < V_{CC} < 5.5 V$ , $f_c = 1 MHz^{(1)}$<br>(rise/fall time $< 50 ns$ )         |             | 2.5          | mA      |
| $I_{CC0}$ | Supply current (Write)                       | During $t_w$ , $2.5 V < V_{CC} < 5.5 V$   |             | $5^{(2)}$    | mA      |
| $I_{CC1}$ | Standby supply current                       | Device not selected <sup>(3)</sup> , $V_{IN} = V_{SS}$ or $V_{CC}$ , $V_{CC} = 2.5 V$ |             | 2            | $\mu A$ |
|           |  | Device not selected <sup>(3)</sup> , $V_{IN} = V_{SS}$ or $V_{CC}$ , $V_{CC} = 5.5 V$ |             | $5^{(4)}$    | $\mu A$ |
| $V_{IL}$  | Input low voltage (SCL, SDA, WC)             |   | -0.45       | $0.3V_{CC}$  | V       |
| $V_{IH}$  | Input high voltage (SCL, SDA)                |   | $0.7V_{CC}$ | 6.5          | V       |
|           | Input high voltage (WC, E2, E1, E0)          |   | $0.7V_{CC}$ | $V_{CC}+0.6$ |         |
| $V_{OL}$  | Output low voltage                           | $I_{OL} = 2.1 mA$ , $V_{CC} = 2.5 V$ or<br>$I_{OL} = 3 mA$ , $V_{CC} = 5.5 V$         |             | 0.4          | V       |

1. Only for devices operating at  $f_c$  max = 1 MHz (see [Table 18](#))
2. Characterized value, not tested in production.
3. The device is not selected after power-up, after a Read instruction (after the Stop condition), or after the completion of the internal write cycle  $t_w$  ( $t_w$  is triggered by the correct decoding of a Write instruction).
4. The new M24C64-W devices (identified by the process letter K) offer  $I_{CC1} = 3\mu A$  (max)

Table 14. DC characteristics (M24xxx-W - device grade 3)

| Symbol    | Parameter                                    | Test conditions (in addition to those in Table 7 and Table 10)              | Min.        | Max.             | Unit    |
|-----------|--|---|-------------|------------------|---------|
| $I_{LI}$  | Input leakage current (SCL, SDA, E2, E1, E0) | $V_{IN} = V_{SS}$ or $V_{CC}$<br>device in Standby mode                     |             | $\pm 2$          | $\mu A$ |
| $I_{LO}$  | Output leakage current                       | SDA in Hi-Z, external voltage applied on SDA: $V_{SS}$ or $V_{CC}$          |             | $\pm 2$          | $\mu A$ |
| $I_{CC}$  | Supply current (Read)                        | $f_c = 400$ kHz   |             | 2                | mA      |
| $I_{CC0}$ | Supply current (Write)                       | During $t_W$  |             | 5 <sup>(1)</sup> | mA      |
| $I_{CC1}$ | Standby supply current                       | Device not selected <sup>(2)</sup> , $V_{IN} = V_{SS}$ or $V_{CC}$          |             | 10               | $\mu A$ |
| $V_{IL}$  | Input low voltage (SCL, SDA, WC)             |   | -0.45       | $0.3V_{CC}$      | V       |
| $V_{IH}$  | Input high voltage (SCL, SDA)                |   | $0.7V_{CC}$ | 6.5              | V       |
|           | Input high voltage (WC, E2, E1, E0)          |   | $0.7V_{CC}$ | $V_{CC}+0.6$     | V       |
| $V_{OL}$  | Output low voltage                           | $I_{OL} = 2.1$ mA, $V_{CC} = 2.5$ V or<br>$I_{OL} = 3$ mA, $V_{CC} = 5.5$ V |             | 0.4              | V       |

1. Characterized value, not tested in production.
2. The device is not selected after power-up, after a Read instruction (after the Stop condition), or after the completion of the internal write cycle  $t_W$  ( $t_W$  is triggered by the correct decoding of a Write instruction).

Table 15. DC characteristics (M24xxx-R - device grade 6)

| Symbol    | Parameter                                | Test conditions <sup>(1)</sup> (in addition to those in <a href="#">Table 8</a> and <a href="#">Table 10</a> ) | Min.         | Max.             | Unit    |
|-----------|--|--|--------------|------------------|---------|
| $I_{LI}$  | Input leakage current (E1, E2, SCL, SDA) | $V_{IN} = V_{SS}$ or $V_{CC}$<br>device in Standby mode  |              | $\pm 2$          | $\mu A$ |
| $I_{LO}$  | Output leakage current                   | SDA in Hi-Z, external voltage applied on SDA: $V_{SS}$ or $V_{CC}$   |              | $\pm 2$          | $\mu A$ |
| $I_{CC}$  | Supply current (Read)                    | $V_{CC} = 1.8 V$ , $f_c = 400 kHz$   |              | 0.8              | mA      |
|           |  | $f_c = 1 MHz$ <sup>(2)</sup>   |              | 2.5              | mA      |
| $I_{CC0}$ | Supply current (Write)                   | During $t_W$ , $1.8 V < V_{CC} < 2.5 V$  |              | 3 <sup>(3)</sup> | mA      |
| $I_{CC1}$ | Standby supply current                   | Device not selected <sup>(4)</sup> ,<br>$V_{IN} = V_{SS}$ or $V_{CC}$ , $V_{CC} = 1.8 V$                       |              | 1                | $\mu A$ |
| $V_{IL}$  | Input low voltage (SCL, SDA, WC)         | $1.8 V \leq V_{CC} < 2.5 V$  | -0.45        | $0.25 V_{CC}$    | V       |
| $V_{IH}$  | Input high voltage (SCL, SDA)            | $1.8 V \leq V_{CC} < 2.5 V$  | $0.75V_{CC}$ | 6.5              | V       |
|           | Input high voltage (WC, E2, E1, E0)      | $1.8 V \leq V_{CC} < 2.5 V$  | $0.75V_{CC}$ | $V_{CC}+0.6$     | V       |
| $V_{OL}$  | Output low voltage                       | $I_{OL} = 1 mA$ , $V_{CC} = 1.8 V$   |              | 0.2              | V       |

1. If the application uses the voltage range R device with  $2.5 V < V_{CC} < 5.5 V$  and  $-40^\circ C < T_A < +85^\circ C$ , please refer to [Table 13](#) instead of this table.
2. Only for devices operating at  $f_c \text{ max} = 1 MHz$  (see [Table 18](#)).
3. Characterized value, not tested in production.
4. The device is not selected after power-up, after a Read instruction (after the Stop condition), or after the completion of the internal write cycle  $t_W$  ( $t_W$  is triggered by the correct decoding of a Write instruction).

Table 16. DC characteristics (M24xxx-F)

| Symbol    | Parameter                                | Test conditions <sup>(1)</sup> (in addition to those in <a href="#">Table 9</a> and <a href="#">Table 10</a> ) | Min.         | Max.             | Unit    |
|-----------|--|--|--------------|------------------|---------|
| $I_{LI}$  | Input leakage current (E1, E2, SCL, SDA) | $V_{IN} = V_{SS}$ or $V_{CC}$<br>device in Standby mode  |              | $\pm 2$          | $\mu A$ |
| $I_{LO}$  | Output leakage current                   | SDA in Hi-Z, external voltage applied on SDA: $V_{SS}$ or $V_{CC}$   |              | $\pm 2$          | $\mu A$ |
| $I_{CC}$  | Supply current (Read)                    | $V_{CC} = 1.7 V$ , $f_c = 400 kHz$   |              | 0.8              | mA      |
|           |  | $f_c = 1 MHz$ <sup>(2)</sup>   |              | 2.5              | mA      |
| $I_{CC0}$ | Supply current (Write)                   | During $t_W$ , $1.7 V < V_{CC} < 2.5 V$  |              | 3 <sup>(3)</sup> | mA      |
| $I_{CC1}$ | Standby supply current                   | Device not selected <sup>(4)</sup> ,<br>$V_{IN} = V_{SS}$ or $V_{CC}$ , $V_{CC} = 1.7 V$                       |              | 1                | $\mu A$ |
| $V_{IL}$  | Input low voltage (SCL, SDA, WC)         | $1.7 V \leq V_{CC} < 2.5 V$  | -0.45        | $0.25 V_{CC}$    | V       |
| $V_{IH}$  | Input high voltage (SCL, SDA)            | $1.7 V \leq V_{CC} < 2.5 V$  | $0.75V_{CC}$ | 6.5              | V       |
|           | Input high voltage (WC, E2, E1, E0)      | $1.7 V \leq V_{CC} < 2.5 V$  | $0.75V_{CC}$ | $V_{CC}+0.6$     | V       |
| $V_{OL}$  | Output low voltage                       | $I_{OL} = 1 mA$ , $V_{CC} = 1.7 V$   |              | 0.2              | V       |

1. If the application uses the voltage range F device with  $2.5 V < V_{CC} < 5.5 V$  and  $-40^\circ C < T_A < +85^\circ C$ , please refer to [Table 13](#) instead of this table.
2. Only for devices operating at  $f_c \text{ max} = 1 MHz$  (see [Table 18](#)).
3. Characterized value, not tested in production.
4. The device is not selected after power-up, after a Read instruction (after the Stop condition), or after the completion of the internal write cycle  $t_W$  ( $t_W$  is triggered by the correct decoding of a Write instruction).

Table 17. 400 kHz AC characteristics

| Symbol              | Alt.         | Parameter <sup>(1)</sup>  | Min.               | Max.               | Unit    |
|---------------------|--------------|---|--------------------|--------------------|---------|
| $f_C$               | $f_{SCL}$    | Clock frequency   | -                  | 400                | kHz     |
| $t_{CHCL}$          | $t_{HIGH}$   | Clock pulse width high  | 600                | -                  | ns      |
| $t_{CLCH}$          | $t_{LOW}$    | Clock pulse width low   | 1300               | -                  | ns      |
| $t_{QL1QL2}^{(2)}$  | $t_F$        | SDA (out) fall time   | 20 <sup>(3)</sup>  | 120                | ns      |
| $t_{XH1XH2}$        | $t_R$        | Input signal rise time  | (4)                | (4)                | ns      |
| $t_{XL1XL2}$        | $t_F$        | Input signal fall time  | (4)                | (4)                | ns      |
| $t_{DXCX}$          | $t_{SU:DAT}$ | Data in set up time   | 100                | -                  | ns      |
| $t_{CLDX}$          | $t_{HD:DAT}$ | Data in hold time   | 0                  | -                  | ns      |
| $t_{CLQX}$          | $t_{DH}$     | Data out hold time  | 100 <sup>(5)</sup> | -                  | ns      |
| $t_{CLQV}^{(6)(7)}$ | $t_{AA}$     | Clock low to next data valid (access time)                        | 100 <sup>(5)</sup> | 900                | ns      |
| $t_{CHDL}$          | $t_{SU:STA}$ | Start condition setup time  | 600                | -                  | ns      |
| $t_{DLCL}$          | $t_{HD:STA}$ | Start condition hold time   | 600                | -                  | ns      |
| $t_{CHDH}$          | $t_{SU:STO}$ | Stop condition set up time  | 600                | -                  | ns      |
| $t_{DHDL}$          | $t_{BUF}$    | Time between Stop condition and next Start condition              | 1300               | -                  | ns      |
| $t_{WLDL}^{(8)(2)}$ | $t_{SU:WC}$  | $\overline{WC}$ set up time (before the Start condition)          | 0                  | -                  | $\mu$ s |
| $t_{DHWL}^{(9)(2)}$ | $t_{HD:WC}$  | $\overline{WC}$ hold time (after the Stop condition)              | 1                  | -                  | $\mu$ s |
| $t_W$               | $t_{WR}$     | Write time  | -                  | 5                  | ms      |
| $t_{NS}^{(2)}$      |              | Pulse width ignored (input filter on SCL and SDA) - single glitch | -                  | 80 <sup>(10)</sup> | ns      |

1. Test conditions (in addition to those in [Table 7](#), [Table 8](#), [Table 9](#) and [Table 10](#)).
2. Characterized value, not tested in production.
3. With  $C_L = 10$  pF.
4. There is no min. or max. values for the input signal rise and fall times. It is however recommended by the I<sup>2</sup>C specification that the input signal rise and fall times be more than 20 ns and less than 300 ns when  $f_C < 400$  kHz.
5. The new M24C64 device (identified by the process letter K) offers  $t_{CLQX} = 100$  ns (min) and  $t_{CLQV} = 100$  ns (min), while the current device offers  $t_{CLQX} = 200$  ns (min) and  $t_{CLQV} = 200$  ns (min). Both series offer a safe margin compared to the I<sup>2</sup>C specification which recommends  $t_{CLQV} = 0$  ns (min).
6. To avoid spurious Start and Stop conditions, a minimum delay is placed between SCL=1 and the falling or rising edge of SDA.
7.  $t_{CLQV}$  is the time (from the falling edge of SCL) required by the SDA bus line to reach either 0.3  $V_{CC}$  or 0.7  $V_{CC}$ , assuming that  $R_{bus} \times C_{bus}$  time constant is within the values specified in [Figure 5](#).
8.  $\overline{WC}=0$  set up time condition to enable the execution of a WRITE command.
9.  $\overline{WC}=0$  hold time condition to enable the execution of a WRITE command.
10. The current M24C64 device offers  $t_{NS}=100$  ns (max), the new M24C64 device (identified by the process letter K) offers  $t_{NS}=80$  ns (max). Both products offer a safe margin compared to the 50 ns minimum value recommended by the I<sup>2</sup>C specification.

Table 18. 1 MHz AC characteristics<sup>(1)</sup>

| Symbol              | Alt.         | Parameter <sup>(2)</sup>                                 | Min. | Max. | Unit    |
|---------------------|--------------|--|------|------|---------|
| $f_C$               | $f_{SCL}$    | Clock frequency  | 0    | 1    | MHz     |
| $t_{CHCL}$          | $t_{HIGH}$   | Clock pulse width high                                   | 260  | -    | ns      |
| $t_{CLCH}$          | $t_{LOW}$    | Clock pulse width low                                    | 400  | -    | ns      |
| $t_{XH1XH2}$        | $t_R$        | Input signal rise time                                   | (3)  | (3)  | ns      |
| $t_{XL1XL2}$        | $t_F$        | Input signal fall time                                   | (3)  | (3)  | ns      |
| $t_{QL1QL2}^{(8)}$  | $t_F$        | SDA (out) fall time                                      | -    | 120  | ns      |
| $t_{DXCX}$          | $t_{SU:DAT}$ | Data in setup time                                       | 50   | -    | ns      |
| $t_{CLDX}$          | $t_{HD:DAT}$ | Data in hold time  | 0    | -    | ns      |
| $t_{CLQX}$          | $t_{DH}$     | Data out hold time                                       | 100  | -    | ns      |
| $t_{CLQV}^{(4)(5)}$ | $t_{AA}$     | Clock low to next data valid (access time)               |      | 450  | ns      |
| $t_{CHDL}$          | $t_{SU:STA}$ | Start condition setup time                               | 250  | -    | ns      |
| $t_{DLCL}$          | $t_{HD:STA}$ | Start condition hold time                                | 250  | -    | ns      |
| $t_{CHDH}$          | $t_{SU:STO}$ | Stop condition setup time                                | 250  | -    | ns      |
| $t_{DHDL}$          | $t_{BUF}$    | Time between Stop condition and next Start condition     | 500  | -    | ns      |
| $t_{WLDL}^{(6)(8)}$ | $t_{SU:WC}$  | $\overline{WC}$ set up time (before the Start condition) | 0    | -    | $\mu$ s |
| $t_{DHWH}^{(7)(8)}$ | $t_{HD:WC}$  | $\overline{WC}$ hold time (after the Stop condition)     | 1    | -    | $\mu$ s |
| $t_W$               | $t_{WR}$     | Write time   | -    | 5    | ms      |
| $t_{NS}^{(8)}$      |              | Pulse width ignored (input filter on SCL and SDA)        | -    | 80   | ns      |

1. Only M24C64 and M24C64-D devices identified by the process letter K are qualified at 1 MHz.
2. Test conditions (in addition to those in [Table 7](#), [Table 8](#), [Table 9](#) and [Table 10](#)).
3. There is no min. or max. values for the input signal rise and fall times. It is however recommended by the I<sup>2</sup>C specification that the input signal rise and fall times be more than 20 ns and less than 300 ns when  $f_C < 400$  kHz, or less than 120 ns when  $f_C < 1$  MHz.
4. To avoid spurious Start and Stop conditions, a minimum delay is placed between SCL=1 and the falling or rising edge of SDA.
5.  $t_{CLQV}$  is the time (from the falling edge of SCL) required by the SDA bus line to reach either 0.3  $V_{CC}$  or 0.7  $V_{CC}$ , assuming that the  $R_{bus} \times C_{bus}$  time constant is within the values specified in [Figure 6](#).
6.  $\overline{WC}=0$  set up time condition to enable the execution of a WRITE command.
7.  $\overline{WC}=0$  hold time condition to enable the execution of a WRITE command.
8. Characterized only, not tested in production.

Figure 14. AC waveforms

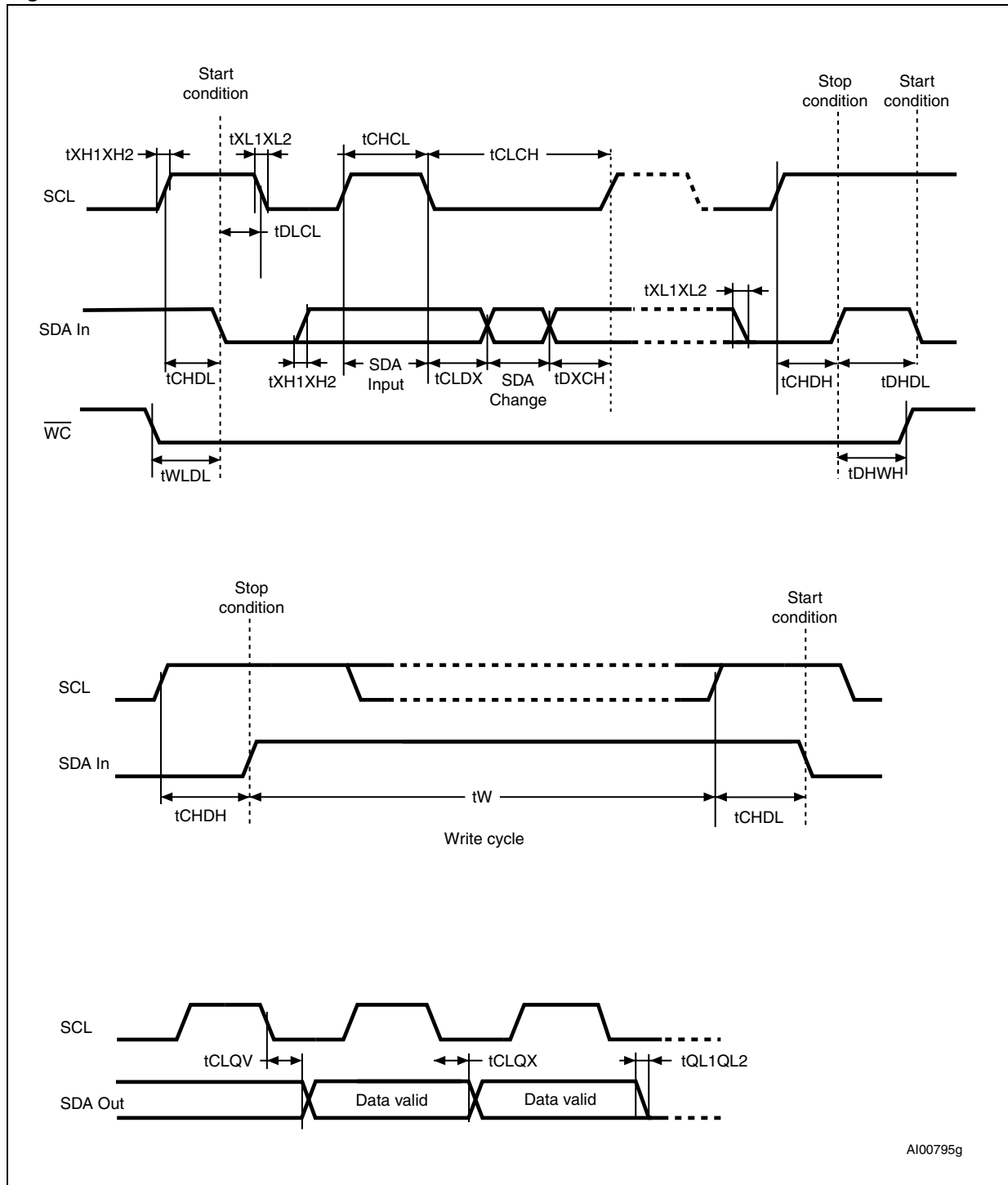

A100795g

## 8 Package mechanical data

In order to meet environmental requirements, ST offers these devices in different grades of ECOPACK<sup>®</sup> packages, depending on their level of environmental compliance. ECOPACK<sup>®</sup> specifications, grade definitions and product status are available at: [www.st.com](http://www.st.com). ECOPACK<sup>®</sup> is an ST trademark.

**Figure 15. PDIP8 – 8 pin plastic DIP, 0.25 mm lead frame, package outline**

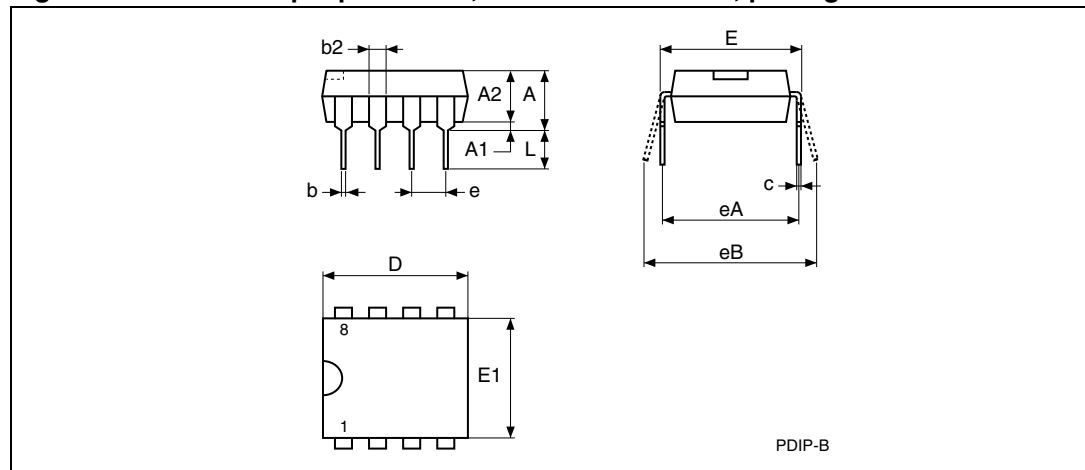

1. Drawing is not to scale.

**Table 19. PDIP8 – 8 pin plastic DIP, 0.25 mm lead frame, package mechanical data**

| Symbol | millimeters |      |       | inches <sup>(1)</sup> |        |        |
|--------|-------------|------|-------|-----------------------|--------|--------|
|        | Typ.        | Min. | Max.  | Typ.                  | Min.   | Max.   |
| A      |             |      | 5.33  |                       |        | 0.2098 |
| A1     |             | 0.38 |       |                       | 0.0150 |        |
| A2     | 3.30        | 2.92 | 4.95  | 0.1299                | 0.1150 | 0.1949 |
| b      | 0.46        | 0.36 | 0.56  | 0.0181                | 0.0142 | 0.0220 |
| b2     | 1.52        | 1.14 | 1.78  | 0.0598                | 0.0449 | 0.0701 |
| c      | 0.25        | 0.20 | 0.36  | 0.0098                | 0.0079 | 0.0142 |
| D      | 9.27        | 9.02 | 10.16 | 0.3650                | 0.3551 | 0.4000 |
| E      | 7.87        | 7.62 | 8.26  | 0.3098                | 0.3000 | 0.3252 |
| E1     | 6.35        | 6.10 | 7.11  | 0.2500                | 0.2402 | 0.2799 |
| e      | 2.54        | –    | –     | 0.1000                | –      | –      |
| eA     | 7.62        | –    | –     | 0.3000                | –      | –      |
| eB     |             |      | 10.92 |                       |        | 0.4299 |
| L      | 3.30        | 2.92 | 3.81  | 0.1299                | 0.1150 | 0.1500 |

1. Values in inches are converted from mm and rounded to four decimal digits.

Figure 16. SO8 narrow – 8 lead plastic small outline, 150 mils body width, package outline

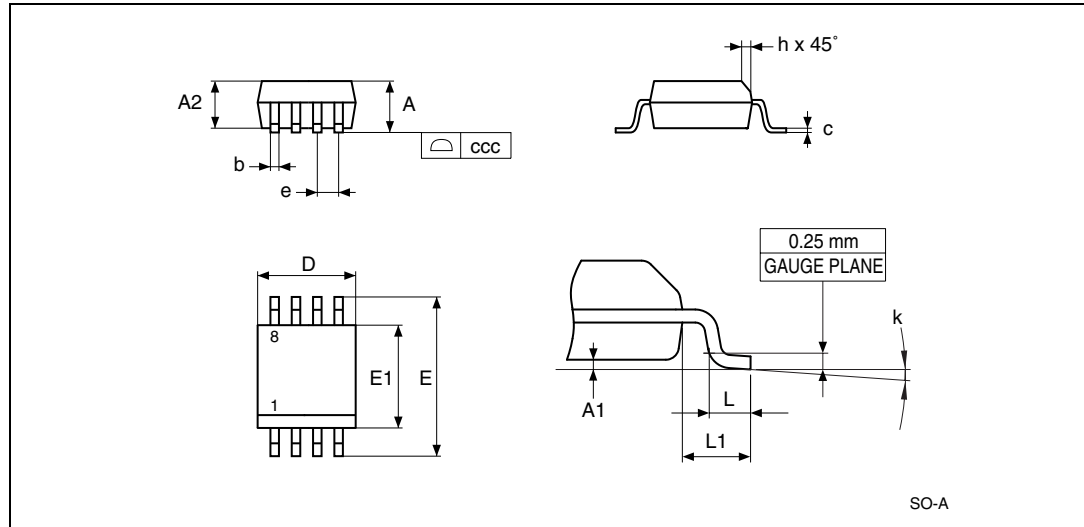

1. Drawing is not to scale.

Table 20. SO8 narrow – 8 lead plastic small outline, 150 mils body width, package mechanical data

| Symbol | millimeters |      |      | inches <sup>(1)</sup> |        |        |
|--------|-------------|------|------|-----------------------|--------|--------|
|        | Typ         | Min  | Max  | Typ                   | Min    | Max    |
| A      |             |      | 1.75 |                       |        | 0.0689 |
| A1     |             | 0.10 | 0.25 |                       | 0.0039 | 0.0098 |
| A2     |             | 1.25 |      |                       | 0.0492 |        |
| b      |             | 0.28 | 0.48 |                       | 0.0110 | 0.0189 |
| c      |             | 0.17 | 0.23 |                       | 0.0067 | 0.0091 |
| ccc    |             |      | 0.10 |                       |        | 0.0039 |
| D      | 4.90        | 4.80 | 5.00 | 0.1929                | 0.1890 | 0.1969 |
| E      | 6.00        | 5.80 | 6.20 | 0.2362                | 0.2283 | 0.2441 |
| E1     | 3.90        | 3.80 | 4.00 | 0.1535                | 0.1496 | 0.1575 |
| e      | 1.27        | –    | –    | 0.0500                | –      | –      |
| h      |             | 0.25 | 0.50 |                       |        |        |
| k      |             | 0°   | 8°   |                       | 0°     | 8°     |
| L      |             | 0.40 | 1.27 |                       | 0.0157 | 0.0500 |
| L1     | 1.04        |      |      | 0.0410                |        |        |

1. Values in inches are converted from mm and rounded to four decimal digits.

Figure 17. TSSOP8 – 8 lead thin shrink small outline, package outline

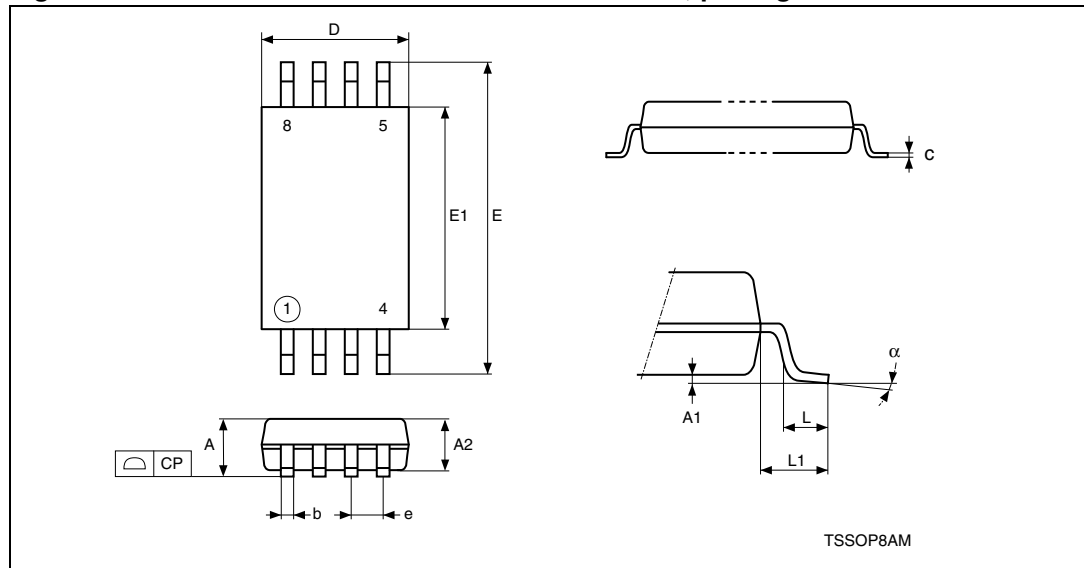

1. Drawing is not to scale.

Table 21. TSSOP8 – 8 lead thin shrink small outline, package mechanical data

| Symbol | millimeters |       |       | inches <sup>(1)</sup> |        |        |
|--------|-------------|-------|-------|-----------------------|--------|--------|
|        | Typ.        | Min.  | Max.  | Typ.                  | Min.   | Max.   |
| A      |             |       | 1.200 |                       |        | 0.0472 |
| A1     |             | 0.050 | 0.150 |                       | 0.0020 | 0.0059 |
| A2     | 1.000       | 0.800 | 1.050 | 0.0394                | 0.0315 | 0.0413 |
| b      |             | 0.190 | 0.300 |                       | 0.0075 | 0.0118 |
| c      |             | 0.090 | 0.200 |                       | 0.0035 | 0.0079 |
| CP     |             |       | 0.100 |                       |        | 0.0039 |
| D      | 3.000       | 2.900 | 3.100 | 0.1181                | 0.1142 | 0.1220 |
| e      | 0.650       | –     | –     | 0.0256                | –      | –      |
| E      | 6.400       | 6.200 | 6.600 | 0.2520                | 0.2441 | 0.2598 |
| E1     | 4.400       | 4.300 | 4.500 | 0.1732                | 0.1693 | 0.1772 |
| L      | 0.600       | 0.450 | 0.750 | 0.0236                | 0.0177 | 0.0295 |
| L1     | 1.000       |       |       | 0.0394                |        |        |
| α      |             | 0°    | 8°    |                       | 0°     | 8°     |

1. Values in inches are converted from mm and rounded to four decimal digits.

**Figure 18. UFDFPN8 (MLP8) – 8-lead ultra thin fine pitch dual flat package no lead 2 × 3mm, package outline**

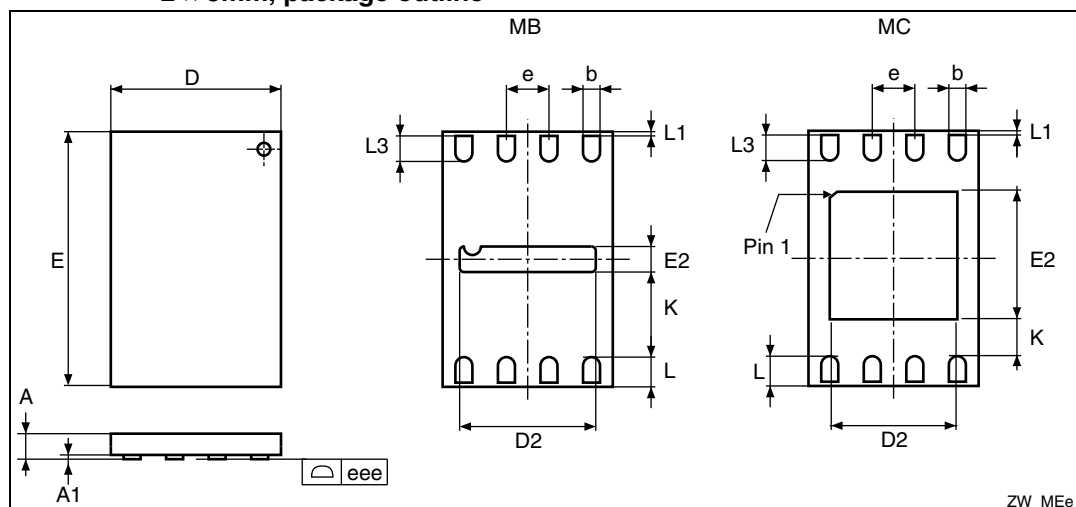

1. Drawing is not to scale.
2. The central pad (E2 × D2 area in the above illustration) is internally pulled to V<sub>SS</sub>. It must not be allowed to be connected to any other voltage or signal line on the PCB, for example during the soldering process.
3. The circle in the top view of the package indicates the position of pin 1.

**Table 22. UFDFPN8 (MLP8) 8-lead ultra thin fine pitch dual flat package no lead 2 × 3 mm, data**

| Symbol             | millimeters |       |       | inches <sup>(1)</sup> |        |        |
|--------------------|-------------|-------|-------|-----------------------|--------|--------|
|                    | Typ         | Min   | Max   | Typ                   | Min    | Max    |
| A                  | 0.550       | 0.450 | 0.600 | 0.0217                | 0.0177 | 0.0236 |
| A1                 | 0.020       | 0.000 | 0.050 | 0.0008                | 0.0000 | 0.0020 |
| b                  | 0.250       | 0.200 | 0.300 | 0.0098                | 0.0079 | 0.0118 |
| D                  | 2.000       | 1.900 | 2.100 | 0.0787                | 0.0748 | 0.0827 |
| D2 (rev MB)        | 1.600       | 1.500 | 1.700 | 0.0630                | 0.0591 | 0.0669 |
| D2 (rev MC)        |             | 1.200 | 1.600 |                       | 0.0472 | 0.0630 |
| E                  | 3.000       | 2.900 | 3.100 | 0.1181                | 0.1142 | 0.1220 |
| E2 (rev MB)        | 0.200       | 0.100 | 0.300 | 0.0079                | 0.0039 | 0.0118 |
| E2 (rev MC)        |             | 1.200 | 1.600 |                       | 0.0472 | 0.0630 |
| e                  | 0.500       |       |       | 0.0197                |        |        |
| K                  |             | 0.300 |       |                       | 0.0118 |        |
| L                  |             | 0.300 | 0.500 |                       | 0.0118 | 0.0197 |
| L1                 |             |       | 0.150 |                       |        | 0.0059 |
| L3                 |             | 0.300 |       |                       | 0.0118 |        |
| eee <sup>(2)</sup> |             | 0.080 |       |                       | 0.0031 |        |

1. Values in inches are converted from mm and rounded to four decimal digits.
2. Applied for exposed die paddle and terminals. Exclude embedding part of exposed die paddle from measuring.

Figure 19. WLCSP-R 5-bump wafer-length chip-scale package outline

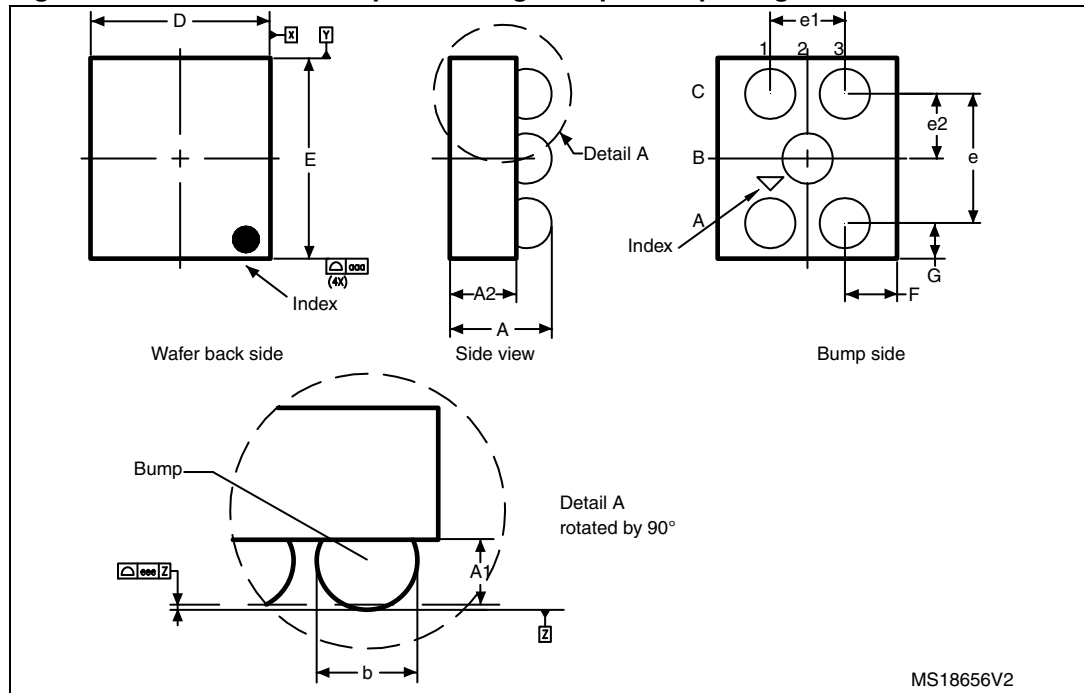

MS18656V2

1. Drawing is not to scale.
2. The index on the wafer back side (circle) is above the index of the bump side (triangle/arrow).

Table 23. WLCSP-R 5-bump wafer-length chip-scale package mechanical data

| Symbol                  | millimeters |       |       | inches <sup>(1)</sup> |        |        |
|-------------------------|-------------|-------|-------|-----------------------|--------|--------|
|                         | Typ         | Min   | Max   | Typ                   | Min    | Max    |
| A                       | 0.545       | 0.490 | 0.600 | 0.0215                | 0.0193 | 0.0236 |
| A1                      | 0.190       |       |       | 0.0075                |        |        |
| A2                      | 0.355       |       |       | 0.0140                |        |        |
| b <sup>(2)</sup>        | 0.270       |       |       | 0.0106                |        |        |
| D                       | 0.959       |       | 1.074 | 0.0378                |        | 0.0423 |
| E                       | 1.073       |       | 1.168 | 0.0422                |        | 0.0460 |
| e                       | 0.693       |       |       | 0.0273                |        |        |
| e1                      | 0.400       |       |       | 0.0157                |        |        |
| e2                      | 0.3465      |       |       | 0.0136                |        |        |
| F                       | 0.280       |       |       | 0.0110                |        |        |
| G                       | 0.190       |       |       | 0.0075                |        |        |
| N (number of terminals) | 5           |       |       | 5                     |        |        |
| aaa                     | 0.110       |       |       |                       |        | 0.0043 |
| eee                     | 0.060       |       |       |                       |        | 0.0024 |

1. Values in inches are converted from mm and rounded to four decimal digits.
2. Dimension measured at the maximum bump diameter parallel to primary datum Z.

## 9 Part numbering

**Table 24. Ordering information scheme**

| Example:   | M24C64-D | W | MN | 6 | T | P | /P |
|--|----------|---|----|---|---|---|----|
| <b>Device type</b><br>M24 = I <sup>2</sup> C serial access EEPROM  |          |   |    |   |   |   |    |
| <b>Device function</b><br>C64 = 64 Kbit (8192 x 8)   |          |   |    |   |   |   |    |
| <b>Device family</b><br>Blank: Without Identification page<br>-D: With additional Identification page  |          |   |    |   |   |   |    |
| <b>Operating voltage</b><br>W = V <sub>CC</sub> = 2.5 V to 5.5 V<br>R = V <sub>CC</sub> = 1.8 V to 5.5 V<br>F = V <sub>CC</sub> = 1.7 V to 5.5 V   |          |   |    |   |   |   |    |
| <b>Package</b><br>BN = PDIP8 <sup>(1)</sup><br>MN = SO8 (150 mil width) <sup>(2)</sup><br>DW = TSSOP8 (169 mil width) <sup>(2)</sup><br>MB or MC = UDFPN8 (MLP8)<br>CS = WLCSP-R   |          |   |    |   |   |   |    |
| <b>Device grade</b><br>6 = Industrial: device tested with standard test flow over -40 to 85 °C<br>5 = Consumer: device tested with standard test flow over -20 to 85°C<br>3 = Device tested with high reliability certified flow <sup>(3)</sup> automotive temperature range (-40 to 125 °C) |          |   |    |   |   |   |    |
| <b>Option</b><br>blank = standard packing<br>T = Tape and reel packing   |          |   |    |   |   |   |    |
| <b>Plating technology</b><br>P or G = ECOPACK <sup>®</sup> (RoHS compliant)  |          |   |    |   |   |   |    |
| <b>Process<sup>(4)</sup></b><br>P = F6DP26% Chartered<br>K = F8H process   |          |   |    |   |   |   |    |

1. ECOPACK1<sup>®</sup> (RoHS-compliant).
2. ECOPACK2<sup>®</sup> (RoHS-compliant and halogen-free).
3. ST strongly recommends the use of Automotive Grade devices for use in an automotive environment. The high reliability certified flow (HRCF) is described in the quality note QNEE9801. Please ask your nearest ST sales office for a copy.
4. Process letter is used only for device grade 3 and WLCSP packages.

For a list of available options (speed, package, etc.) or for further information on any aspect of this device, please contact your nearest ST sales office.

## 10 Revision history

**Table 25. Document revision history**

| Date        | Revision | Changes   |
|-------------|----------|---|
| 22-Dec-1999 | 2.3      | TSSOP8 package in place of TSSOP14 (pp 1, 2, OrderingInfo, PackageMechData).  |
| 28-Jun-2000 | 2.4      | TSSOP8 package data corrected   |
| 31-Oct-2000 | 2.5      | References to Temperature Range 3 removed from Ordering Information<br>Voltage range -S added, and range -R removed from text and tables throughout.  |
| 20-Apr-2001 | 2.6      | Lead Soldering Temperature in the Absolute Maximum Ratings table amended<br>Write Cycle Polling Flow Chart using ACK illustration updated<br>References to PSDIP changed to PDIP and Package Mechanical data updated                                      |
| 16-Jan-2002 | 2.7      | Test condition for $I_{L1}$ made more precise, and value of $I_{L1}$ for E2-E0 and $\overline{WC}$ added<br>-R voltage range added  |
| 02-Aug-2002 | 2.8      | Document reformatted using new template.<br>TSSOP8 (3x3mm <sup>2</sup> body size) package (MSOP8) added.<br>5ms write time offered for 5V and 2.5V devices  |
| 04-Feb-2003 | 2.9      | SO8W package removed. -S voltage range removed  |
| 27-May-2003 | 2.10     | TSSOP8 (3x3mm <sup>2</sup> body size) package (MSOP8) removed   |
| 22-Oct-2003 | 3.0      | Table of contents, and Pb-free options added. Minor wording changes in Summary Description, Power-On Reset, Memory Addressing, Write Operations, Read Operations. $V_{IL}(\min)$ improved to -0.45V.  |
| 01-Jun-2004 | 4.0      | Absolute Maximum Ratings for $V_{IO}(\min)$ and $V_{CC}(\min)$ improved.<br>Soldering temperature information clarified for RoHS compliant devices.<br>Device Grade clarified   |
| 04-Nov-2004 | 5.0      | Product List summary table added. Device Grade 3 added. 4.5-5.5V range is Not for New Design. Some minor wording changes. AEC-Q100-002 compliance. $t_{NS}(\max)$ changed. $V_{IL}(\min)$ is the same on all input pins of the device. $Z_{WCL}$ changed. |
| 05-Jan-2005 | 6.0      | UFDFPN8 package added. Small text changes.  |

Table 25. Document revision history (continued)

| Date        | Revision | Changes   |
|-------------|----------|---|
| 29-Jun-2006 | 7        | <p>Document converted to new ST template.</p> <p>M24C32 and M24C64 products (4.5 to 5.5V supply voltage) removed. M24C64 and M24C32 products (1.7 to 5.5V supply voltage) added.</p> <p><a href="#">Section 2.3: Chip Enable (E2, E1, E0)</a> and <a href="#">Section 2.4: Write Control (WC)</a> modified, <a href="#">Section 2.6: Supply voltage (VCC)</a> added and replaces <a href="#">Power On Reset: VCC Lock-Out Write Protect</a> section.</p> <p><math>T_A</math> added, <a href="#">Note 1</a> updated and <math>T_{LEAD}</math> specified for PDIP packages in <a href="#">Table 6: Absolute maximum ratings</a>.</p> <p><math>I_{CC0}</math> added, <math>I_{CC}</math> voltage conditions changed and <math>I_{CC1}</math> specified over the whole voltage range in <a href="#">Table 24: DC characteristics (M24xxx-W, device grade 6)</a>.</p> <p><math>I_{CC0}</math> added, <math>I_{CC}</math> frequency conditions changed and <math>I_{CC1}</math> specified over the whole voltage range in <a href="#">Table 26: DC characteristics (M24xxx-R - device grade 6)</a>.</p> <p><math>t_W</math> modified in <a href="#">Table 28: AC characteristics</a>.</p> <p>SO8N package specifications updated (see <a href="#">Figure 16</a> and <a href="#">Table 20</a>).</p> <p>Device grade 5 added, B and P Process letters added to <a href="#">Table 24: Ordering information scheme</a>. Small text changes.</p> |
| 03-Jul-2006 | 8        | <p><math>I_{CC1}</math> modified in <a href="#">Table 24: DC characteristics (M24xxx-W, device grade 6)</a>.</p> <p><a href="#">Note 1</a> added to <a href="#">Table 27: DC characteristics (M24xxx-F)</a> and table title modified.</p>   |
| 17-Oct-2006 | 9        | <p>UFDFPN8 package specifications updated (see <a href="#">Table 21</a>). M24128-BW- and M24128-BR part numbers added.</p> <p>Generic part number corrected in <a href="#">Features on page 1</a>.</p> <p><math>I_{CC0}</math> corrected in <a href="#">Table 25</a> and <a href="#">Table 24</a>.</p> <p>Packages are ECOPACK® compliant.</p>  |
| 27-Apr-2007 | 10       | <p>Available packages and temperature ranges by product specified in <a href="#">Table 22</a>, <a href="#">Table 24</a> and <a href="#">Table 25</a>.</p> <p>Notes modified below <a href="#">Table 23: Input parameters</a>.</p> <p><math>V_{IH}</math> max modified in DC characteristics tables (see <a href="#">Table 24</a>, <a href="#">Table 25</a>, <a href="#">Table 26</a> and <a href="#">Table 27</a>).</p> <p>C process code added to <a href="#">Table 24: Ordering information scheme</a>.</p> <p>For M24xxx-R (1.8 V to 5.5 V range) products assembled from July 2007 on, <math>t_W</math> will be 5 ms (see <a href="#">Table 28: AC characteristics</a>).</p>  |
| 27-Nov-2007 | 11       | <p>Small text changes. <a href="#">Section 2.5: VSS ground</a> and <a href="#">Section 4.9: ECC (error correction code) and write cycling</a> added.</p> <p><math>V_{IL}</math> and <math>V_{IH}</math> modified in <a href="#">Table 26: DC characteristics (M24xxx-R - device grade 6)</a>.</p> <p>JEDEC standard reference updated below <a href="#">Table 6: Absolute maximum ratings</a>.</p> <p>Package mechanical data inch values calculated from mm and rounded to 4 decimal digits (see <a href="#">Section 8: Package mechanical data</a>).</p>  |

Table 25. Document revision history (continued)

| Date        | Revision | Changes  |
|-------------|----------|--|
| 18-Dec-2007 | 12       | <p>Added <a href="#">Section 2.6.2: Power-up conditions</a>, updated <a href="#">Section 2.6.3: Device reset</a>, and <a href="#">Section 2.6.4: Power-down conditions</a> in <a href="#">Section 2.6: Supply voltage (VCC)</a>.</p> <p>Updated <a href="#">Figure 5: I2C Fast mode (fC = 400 kHz): maximum Rbus value versus bus parasitic capacitance (Cbus)</a>.</p> <p>Replace M24128 and M24C64 by M24128-BFMB6 and M24C64-FMB6, respectively, in <a href="#">Section 4.9: ECC (error correction code) and write cycling</a>.</p> <p>Added temperature grade 6 in <a href="#">Table 21: Operating conditions (M24xxx-F)</a>.</p> <p>Updated test conditions for <math>I_{LO}</math> and <math>V_{LO}</math> in <a href="#">Table 24: DC characteristics (M24xxx-W, device grade 6)</a>, <a href="#">Table 25: DC characteristics (M24xxx-W, device grade 3)</a>, and <a href="#">Table 26: DC characteristics (M24xxx-R - device grade 6)</a>.</p> <p>Test condition updated for <math>I_{LO}</math>, and <math>V_{IH}</math> and <math>V_{IL}</math> differentiate for <math>1.8\text{ V} \leq V_{CC} &lt; 2.5\text{ V}</math> and <math>2.5\text{ V} \leq V_{CC} &lt; 5.5\text{ V}</math> in <a href="#">Table 27: DC characteristics (M24xxx-F)</a>.</p> <p>Updated <a href="#">Table 28: AC characteristics</a>, and <a href="#">Table 17: AC characteristics (M24xxx-F)</a>.</p> <p>Updated <a href="#">Figure 14: AC waveforms</a>.</p> <p>Added M24128-BF in <a href="#">Table 25: Available M24C32 products (package, voltage range, temperature grade)</a>.</p> <p>Process B removed from <a href="#">Table 24: Ordering information scheme</a>.</p> |
| 30-May-2008 | 13       | <p>Small text changes.</p> <p>C <a href="#">Process</a> option and Blank <a href="#">Plating technology</a> option removed from <a href="#">Table 24: Ordering information scheme</a>.</p>   |
| 15-Jul-2008 | 14       | <p>WLCSP package added (see <a href="#">Figure 3: WLCSP connections (top view, marking side, with balls on the underside)</a> and <a href="#">Section 8: Package mechanical data</a>). <a href="#">Section 4.9: ECC (error correction code) and write cycling</a> updated.</p>   |
| 16-Sep-2008 | 15       | <p><math>I_{OL}</math> added to <a href="#">Table 6: Absolute maximum ratings</a>.</p> <p><a href="#">Table 24: Available M24C32 products (package, voltage range, temperature grade)</a> and <a href="#">Table 25: Available M24C32 products (package, voltage range, temperature grade)</a> updated.</p>   |
| 05-Jan-2009 | 16       | <p>I2C modes supported specified in <a href="#">Features on page 1</a>.</p> <p>Note removed from <a href="#">Table 27: DC characteristics (M24xxx-F)</a>. Small text changes.</p>  |

Table 25. Document revision history (continued)

| Date        | Revision | Changes  |
|-------------|----------|--|
| 10-Dec-2009 | 17       | <p>32 and 128 Kbit densities removed.</p> <p>ECOPACK status of packages specified <i>on page 1</i> and in <i>Table 24: Ordering information scheme</i>.</p> <p><i>Section 2.6.2: Power-up conditions</i> updated.</p> <p><i>Figure 5: I2C Fast mode (fC = 400 kHz): maximum Rbus value versus bus parasitic capacitance (Cbus)</i> updated. ECC section removed.</p> <p><math>t_{NS}</math> modified in <i>Table 23: Input parameters</i>.</p> <p><math>I_{CC1}</math> and <math>V_{IH}</math> updated in <i>Table 24: DC characteristics (M24xxx-W, device grade 6)</i>, <i>Table 25: DC characteristics (M24xxx-W, device grade 3)</i>, <i>Table 26: DC characteristics (M24xxx-R - device grade 6)</i> and <i>Table 27: DC characteristics (M24xxx-F)</i>. Note added to <i>Table 26: DC characteristics (M24xxx-R - device grade 6)</i>.</p> <p><i>Table 28: AC characteristics</i> modified.</p> <p><i>Figure 14: AC waveforms</i> modified.</p> <p>Note added below <i>Figure 18: UFDFPN8 (MLP8) – 8-lead ultra thin fine pitch dual flat package no lead 2 × 3mm, package outline</i>.</p> <p>Small text changes.</p> |
| 05-Feb-2010 | 18       | Number of bytes changed for Page Write in <i>Table 5: Operating modes</i> .  |
| 15-Sep-2010 | 19       | <p>Updated tables (process letter K) under <i>Section 6</i>:</p> <ul style="list-style-type: none"> <li>– <i>Table 6: ESD HBM passes 3000 V</i></li> </ul> <p>Updated tables (process letter K) under <i>Section 7</i>:</p> <ul style="list-style-type: none"> <li>– <i>Table 18 (1MHz AC)</i> inserted,</li> <li>– <i>Table 17, Table 18: Tclkv(min) = 100 ns</i></li> <li>– <i>Table 17, Table 18: tNS = 80 ns</i></li> </ul>  |
| 16-Nov-2010 | 20       | <p>Added M24C64-DF device.</p> <p>Updated <i>Features, Section 1: Description, Section 4: Device operation</i>.</p> <p>Changed title of <i>Figure 2: 8-pin package connections</i>.</p> <p>Updated <i>Table 10: AC test measurement conditions</i>.</p> <p>Replaced <i>Figure 18: UFDFPN8 (MLP8) – 8-lead ultra thin fine pitch dual flat package no lead 2 × 3mm, package outline</i> and <i>Table 21: UFDFPN8 (MLP8) – 8-lead ultra thin fine pitch dual flat package no lead 2 × 3mm, data</i>.</p> <p>Added <i>Table 29: M24C32-D product (package, voltage range, temperature grade)</i>.</p>   |
| 08-Dec-2010 | 21       | <p>Added WLCSP in <i>Features</i> and <i>Figure 4: WLCSP connections (top view)</i>.</p> <p>Updated <i>Table 22: UFDFPN8 (MLP8) 8-lead ultra thin fine pitch dual flat package no lead 2 × 3 mm, data</i>.</p> <p>Updated <i>Table 26: Available M24C32 products (package, voltage range, temperature grade)</i> and <i>Table 29: M24C32-D product (package, voltage range, temperature grade)</i>.</p>  |
| 14-Mar-2011 | 22       | <p>Updated information concerning E2, E1, E0 for the WLCSP package:</p> <ul style="list-style-type: none"> <li>– note under <i>Figure 3: WLCSP connections (top view)</i></li> <li>– comment under <i>Figure 4: Device select code</i></li> <li>– note <sup>(3)</sup> under <i>Table 2: Device select code</i></li> </ul>  |

Table 25. Document revision history (continued)

| Date        | Revision | Changes  |
|-------------|----------|--|
| 07-Apr-2011 | 23       | Updated MLP8 package data and <a href="#">Section 9: Part numbering</a> .<br>Added footnote <sup>(a)</sup> in <a href="#">Section 4.5: Memory addressing</a> .   |
| 18-May-2011 | 24       | Updated:<br>– <a href="#">Figure 3: WLCSP connections (top view)</a><br>– <a href="#">Table 6: Absolute maximum ratings</a><br>– <a href="#">Small text changes</a><br>Added:<br>– <a href="#">Figure 12: Memory cell characteristics</a>  |
| 08-Sep-2011 | 25       | Updated:<br>– <a href="#">Table 22: UFDFPN8 (MLP8) 8-lead ultra thin fine pitch dual flat package no lead 2 x 3 mm, data</a><br>– <a href="#">Figure 5: I2C Fast mode (fC = 400 kHz): maximum Rbus value versus bus parasitic capacitance (Cbus)</a><br>– <a href="#">Figure 6: I2C Fast mode Plus (fC = 1 MHz): maximum Rbus value versus bus parasitic capacitance (Cbus)</a> .<br>Added t <sub>WLDL</sub> and t <sub>DHWH</sub> in:<br>– <a href="#">Table 17: 400 kHz AC characteristics</a><br>– <a href="#">Table 18: 1 MHz AC characteristics</a><br>– <a href="#">Figure 14: AC waveforms</a><br>Minor text changes. |
| 16-Dec-2011 | 26       | Updated A dimension in <a href="#">Table 23: WLCSP-R 5-bump wafer-length chip-scale package mechanical data</a> .  |

**Please Read Carefully:**

Information in this document is provided solely in connection with ST products. STMicroelectronics NV and its subsidiaries ("ST") reserve the right to make changes, corrections, modifications or improvements, to this document, and the products and services described herein at any time, without notice.

All ST products are sold pursuant to ST's terms and conditions of sale.

Purchasers are solely responsible for the choice, selection and use of the ST products and services described herein, and ST assumes no liability whatsoever relating to the choice, selection or use of the ST products and services described herein.

No license, express or implied, by estoppel or otherwise, to any intellectual property rights is granted under this document. If any part of this document refers to any third party products or services it shall not be deemed a license grant by ST for the use of such third party products or services, or any intellectual property contained therein or considered as a warranty covering the use in any manner whatsoever of such third party products or services or any intellectual property contained therein.

**UNLESS OTHERWISE SET FORTH IN ST'S TERMS AND CONDITIONS OF SALE ST DISCLAIMS ANY EXPRESS OR IMPLIED WARRANTY WITH RESPECT TO THE USE AND/OR SALE OF ST PRODUCTS INCLUDING WITHOUT LIMITATION IMPLIED WARRANTIES OF MERCHANTABILITY, FITNESS FOR A PARTICULAR PURPOSE (AND THEIR EQUIVALENTS UNDER THE LAWS OF ANY JURISDICTION), OR INFRINGEMENT OF ANY PATENT, COPYRIGHT OR OTHER INTELLECTUAL PROPERTY RIGHT.**

**UNLESS EXPRESSLY APPROVED IN WRITING BY TWO AUTHORIZED ST REPRESENTATIVES, ST PRODUCTS ARE NOT RECOMMENDED, AUTHORIZED OR WARRANTED FOR USE IN MILITARY, AIR CRAFT, SPACE, LIFE SAVING, OR LIFE SUSTAINING APPLICATIONS, NOR IN PRODUCTS OR SYSTEMS WHERE FAILURE OR MALFUNCTION MAY RESULT IN PERSONAL INJURY, DEATH, OR SEVERE PROPERTY OR ENVIRONMENTAL DAMAGE. ST PRODUCTS WHICH ARE NOT SPECIFIED AS "AUTOMOTIVE GRADE" MAY ONLY BE USED IN AUTOMOTIVE APPLICATIONS AT USER'S OWN RISK.**

Resale of ST products with provisions different from the statements and/or technical features set forth in this document shall immediately void any warranty granted by ST for the ST product or service described herein and shall not create or extend in any manner whatsoever, any liability of ST.

ST and the ST logo are trademarks or registered trademarks of ST in various countries.

Information in this document supersedes and replaces all information previously supplied.

The ST logo is a registered trademark of STMicroelectronics. All other names are the property of their respective owners.

© 2011 STMicroelectronics - All rights reserved



STMicroelectronics group of companies

Australia - Belgium - Brazil - Canada - China - Czech Republic - Finland - France - Germany - Hong Kong - India - Israel - Italy - Japan - Malaysia - Malta - Morocco - Philippines - Singapore - Spain - Sweden - Switzerland - United Kingdom - United States of America





[www.st.com](http://www.st.com)

## Looking for pricing, stock, or lifecycle information?

Click below to explore more details on WIN SOURCE:

-  [View M24C64-FMB6TG on WIN SOURCE](#)
-  [STMicroelectronics](#) Information

## Optimize Your Supply Chain with WIN SOURCE Solutions

-  Global Sourcing Solution
-  Obsolete Management
-  Cost Control Management
-  Shortage Management
-  Alternative Solution
-  Excess Inventory Management