



**THE DATASHEET OF  
MADP-008120-12790T**



## Surface Mount Plastic PIN Diodes

Rev. V5

### Features

- Industry Standard Surface Mount Package (SC-79)
- Lead-Free (RoHS Compliant)  
Available with 260 °C Reflow Compatibility
- Low Loss, High Isolation Switching Diodes
- Tape and Reel Packaging

### Description and Applications

M/A-COM offers a silicon PIN diode in low cost, surface mount plastic package for use as a switch where low loss and high isolation is required. These diodes are offered as an RoHS compliant device with 100% matte Sn plating. This particular PIN diode was designed to accommodate circuits requiring the benefits of low resistance and requiring low capacitance for various microwave control circuit applications.

This PIN diode is available in the SC-79 (case style 1279) package. This package is supplied on tape and reel for automatic pick and place assembly. The tape and reel suffix designation is a "T" at the end of the part number.

### Absolute Maximum Ratings

@ 25 °C<sup>1</sup> (Unless Otherwise Noted)

Parameter	Absolute Maximum
Operating Temperature	-65°C to +125 °C
Storage Temperature	-65°C to +150 °C
Junction Temperature	+ 175 °C
Reverse Voltage	Voltage Rating
Forward Current	150 mA DC

### Electrical Specifications @ 25°C

Standard Part Number	Reverse Voltage <sup>1</sup> (V)	Junction Capacitance <sup>2</sup> Max. (pF)	Total Capacitance <sup>2</sup> Max. (pF)	R <sub>s</sub> @ 10 mA <sup>3</sup> Max. (Ohms)	Nominal Characteristics	
					Carrier Lifetime <sup>4</sup> (ns)	I-Region Thickness (um)
MADP-008120-12790T	100	0.060@ 10V	0.150@ 10V	2.5	200	19

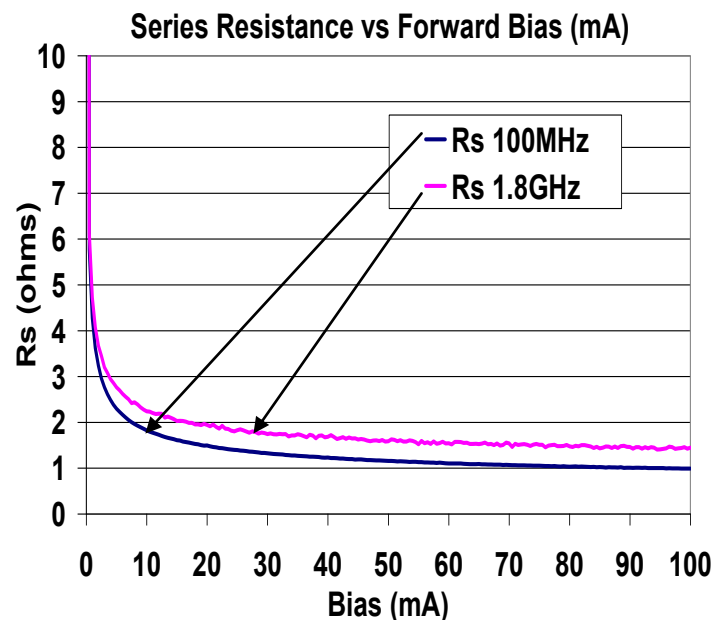
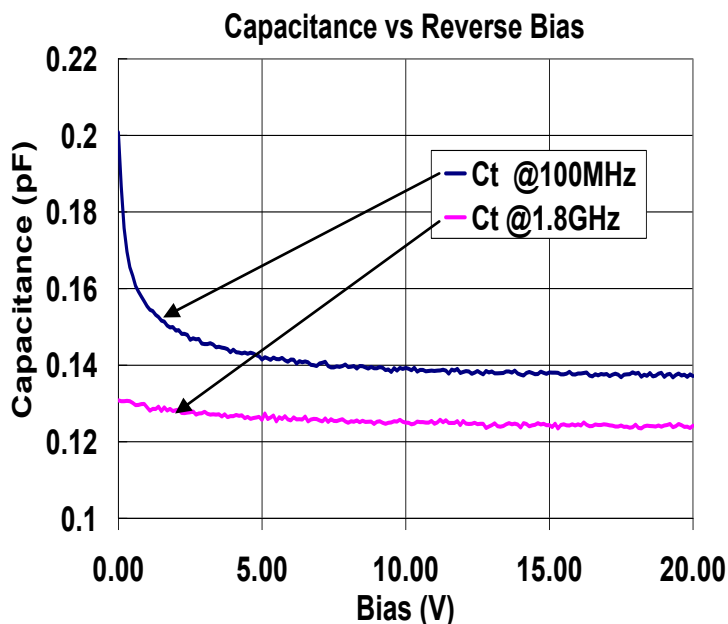

## Typical RF Performance

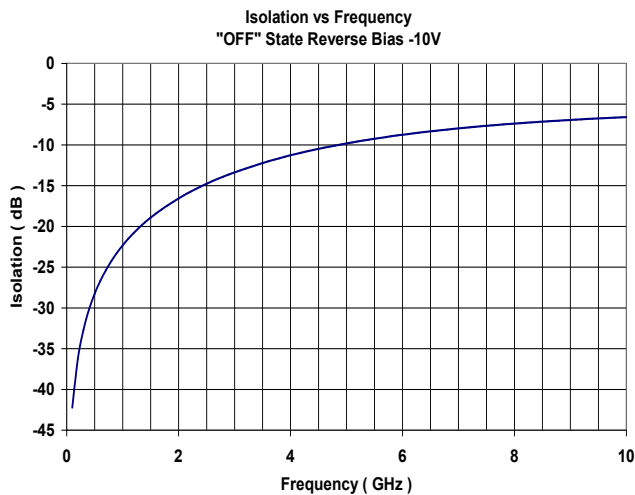
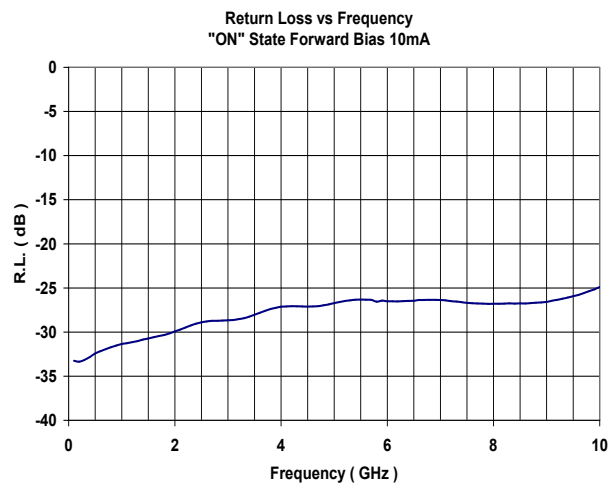
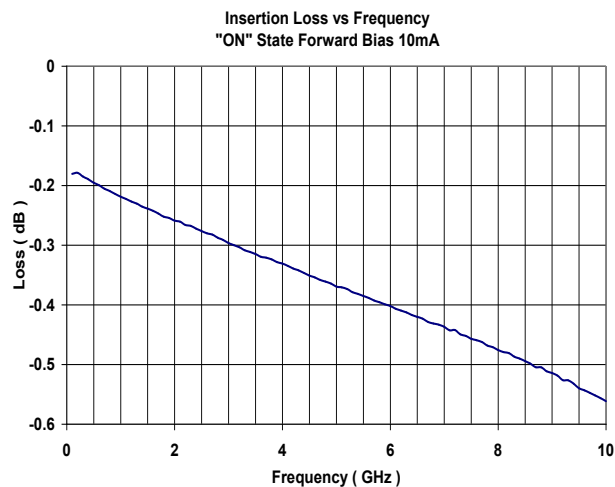

Devices mounted in series configuration and fixture losses removed from data.

# MADP-008120-12790T



## Surface Mount Plastic PIN Diodes

Rev. V5

### S-Parameter Data

MADP-008120-12790T

Insertion Loss @ 10 mA, 1V in Single Series Diode Configuration, Z0 = 50 Ohms

F (GHz)	S11 Mag	S11 Ang	S21 Mag	S21 Ang	S12 Mag	S12 Ang	S22 Mag	S22 Ang
0.100	0.022	-15.170	0.979	-0.570	0.979	-0.570	0.021	-11.230
0.200	0.021	-9.400	0.980	-1.560	0.980	-1.560	0.021	-4.320
0.300	0.022	-8.740	0.979	-2.470	0.979	-2.470	0.022	-1.650
0.400	0.023	-9.470	0.978	-3.320	0.978	-3.320	0.023	-1.510
0.500	0.024	-9.420	0.978	-4.140	0.978	-4.140	0.024	-4.040
0.600	0.025	-9.370	0.977	-4.960	0.977	-4.960	0.025	-7.280
0.700	0.025	-9.560	0.977	-5.790	0.977	-5.790	0.025	-11.080
0.800	0.026	-9.630	0.976	-6.600	0.976	-6.600	0.026	-14.950
0.900	0.027	-10.130	0.976	-7.410	0.976	-7.410	0.027	-18.340
1.000	0.027	-11.180	0.975	-8.210	0.975	-8.200	0.027	-21.010
1.100	0.027	-13.470	0.975	-9.020	0.975	-9.020	0.028	-22.930
1.200	0.028	-16.910	0.974	-9.820	0.974	-9.820	0.028	-23.660
1.300	0.028	-20.680	0.974	-10.620	0.974	-10.620	0.029	-24.110
1.400	0.029	-24.730	0.973	-11.410	0.973	-11.410	0.029	-24.180
1.500	0.029	-28.640	0.973	-12.220	0.973	-12.220	0.030	-24.360
1.600	0.030	-31.880	0.972	-13.020	0.972	-13.020	0.030	-25.130
1.700	0.030	-34.670	0.972	-13.830	0.972	-13.830	0.031	-26.720
1.800	0.030	-36.090	0.971	-14.600	0.971	-14.600	0.031	-28.760
1.900	0.031	-36.820	0.971	-15.400	0.971	-15.400	0.032	-31.590
2.000	0.032	-37.230	0.971	-16.200	0.971	-16.200	0.033	-34.700
2.100	0.033	-37.670	0.970	-16.990	0.970	-16.990	0.034	-37.980
2.200	0.034	-38.210	0.970	-17.780	0.970	-17.780	0.035	-40.890
2.300	0.034	-39.030	0.970	-18.580	0.970	-18.580	0.036	-43.210
2.400	0.035	-40.590	0.969	-19.380	0.969	-19.380	0.037	-45.310
2.500	0.036	-42.350	0.969	-20.180	0.969	-20.180	0.038	-46.570
2.600	0.036	-44.820	0.968	-20.970	0.968	-20.970	0.038	-47.510
2.700	0.037	-47.340	0.968	-21.760	0.968	-21.760	0.039	-48.060
2.800	0.037	-49.970	0.967	-22.550	0.967	-22.550	0.040	-48.590
2.900	0.037	-52.490	0.967	-23.350	0.967	-23.350	0.040	-49.080
3.000	0.037	-54.590	0.966	-24.130	0.966	-24.130	0.041	-49.680
3.100	0.037	-56.300	0.966	-24.920	0.966	-24.920	0.041	-50.610
3.200	0.037	-57.680	0.966	-25.730	0.966	-25.730	0.042	-51.850
3.300	0.038	-58.500	0.965	-26.500	0.965	-26.500	0.043	-53.420
3.400	0.039	-59.150	0.965	-27.290	0.965	-27.290	0.043	-55.100
3.500	0.040	-59.900	0.964	-28.090	0.964	-28.090	0.044	-56.800
3.600	0.041	-60.440	0.964	-28.870	0.964	-28.870	0.045	-58.680
3.700	0.042	-61.400	0.964	-29.670	0.964	-29.670	0.046	-60.340
3.800	0.043	-62.360	0.963	-30.470	0.963	-30.470	0.047	-61.840
3.900	0.043	-63.520	0.963	-31.250	0.963	-31.250	0.048	-62.860
4.000	0.044	-64.980	0.963	-32.050	0.963	-32.050	0.049	-63.740
4.100	0.044	-66.650	0.962	-32.850	0.962	-32.850	0.049	-64.400
4.200	0.044	-68.080	0.962	-33.630	0.962	-33.630	0.050	-65.020
4.300	0.044	-69.560	0.961	-34.430	0.961	-34.430	0.050	-65.500
4.400	0.044	-70.860	0.961	-35.220	0.961	-35.220	0.051	-65.810
4.500	0.044	-72.070	0.960	-36.010	0.960	-36.010	0.051	-66.470
4.600	0.044	-72.940	0.960	-36.810	0.960	-36.810	0.051	-67.090
4.700	0.044	-73.710	0.960	-37.590	0.960	-37.590	0.052	-67.830
4.800	0.045	-74.390	0.959	-38.390	0.959	-38.390	0.053	-68.770
4.900	0.045	-74.990	0.959	-39.190	0.959	-39.190	0.053	-69.830
5.000	0.046	-75.460	0.958	-39.980	0.958	-39.980	0.054	-70.850
5.100	0.047	-76.260	0.958	-40.780	0.958	-40.780	0.054	-71.980
5.200	0.047	-77.020	0.958	-41.590	0.958	-41.590	0.055	-72.950
5.300	0.048	-77.800	0.957	-42.380	0.957	-42.380	0.056	-73.660
5.400	0.048	-78.490	0.957	-43.180	0.957	-43.180	0.056	-74.540
5.500	0.048	-79.410	0.957	-43.980	0.957	-43.980	0.057	-74.980
5.600	0.048	-80.330	0.956	-44.770	0.956	-44.770	0.057	-75.490
5.700	0.048	-81.070	0.956	-45.570	0.956	-45.570	0.058	-75.750
5.800	0.047	-82.150	0.955	-46.370	0.955	-46.370	0.057	-76.580
5.900	0.048	-82.340	0.955	-47.170	0.955	-47.170	0.058	-76.030
6.000	0.047	-82.800	0.955	-47.970	0.955	-47.970	0.058	-76.240
6.100	0.047	-83.130	0.954	-48.770	0.954	-48.770	0.058	-76.300
6.200	0.047	-83.430	0.954	-49.590	0.954	-49.590	0.059	-76.650
6.300	0.047	-83.650	0.954	-50.380	0.954	-50.380	0.059	-76.890
6.400	0.048	-84.070	0.953	-51.180	0.953	-51.180	0.059	-77.260
6.500	0.048	-84.640	0.953	-51.990	0.953	-51.990	0.059	-78.150
6.600	0.048	-84.660	0.952	-52.800	0.952	-52.800	0.059	-78.220
6.700	0.048	-84.970	0.952	-53.610	0.952	-53.610	0.059	-78.730
6.800	0.048	-85.190	0.952	-54.420	0.952	-54.420	0.059	-79.130
6.900	0.048	-85.460	0.951	-55.230	0.951	-55.230	0.059	-79.460
7.000	0.048	-85.580	0.951	-56.050	0.951	-56.050	0.060	-79.700
7.100	0.048	-85.550	0.950	-56.850	0.950	-56.850	0.060	-79.860
7.200	0.047	-85.290	0.950	-57.680	0.950	-57.680	0.060	-79.560
7.300	0.047	-85.250	0.950	-58.490	0.950	-58.490	0.060	-79.430
7.400	0.047	-84.700	0.949	-59.310	0.949	-59.310	0.060	-79.170
7.500	0.046	-84.300	0.949	-60.120	0.949	-60.120	0.060	-78.790
7.600	0.046	-84.020	0.948	-60.940	0.948	-60.940	0.060	-78.360
7.700	0.046	-83.400	0.948	-61.770	0.948	-61.770	0.060	-77.920
7.800	0.046	-82.890	0.948	-62.580	0.948	-62.580	0.060	-77.490
7.900	0.046	-82.280	0.947	-63.400	0.947	-63.400	0.060	-77.120
8.000	0.046	-81.610	0.947	-64.220	0.947	-64.220	0.060	-76.540
8.100	0.046	-80.960	0.946	-65.050	0.946	-65.050	0.060	-76.370
8.200	0.046	-80.450	0.946	-65.870	0.946	-65.870	0.060	-76.880
8.300	0.046	-79.740	0.945	-66.710	0.945	-66.710	0.060	-75.310
8.400	0.046	-78.800	0.945	-67.550	0.945	-67.550	0.060	-74.840
8.500	0.046	-77.850	0.945	-68.380	0.945	-68.380	0.060	-74.380
8.600	0.046	-76.690	0.944	-69.200	0.944	-69.200	0.060	-73.720
8.700	0.046	-75.220	0.944	-70.030	0.944	-70.030	0.060	-72.950
8.800	0.046	-73.840	0.944	-70.880	0.944	-70.880	0.061	-72.390
8.900	0.047	-72.270	0.943	-71.710	0.943	-71.710	0.061	-71.000
9.000	0.047	-70.680	0.943	-72.560	0.943	-72.560	0.062	-70.000
9.100	0.048	-69.190	0.942	-73.400	0.942	-73.400	0.062	-68.900
9.200	0.048	-67.550	0.941	-74.250	0.941	-74.250	0.062	-67.920
9.300	0.049	-66.230	0.941	-75.090	0.941	-75.090	0.063	-66.540
9.400	0.050	-64.590	0.941	-75.930	0.941	-75.930	0.063	-65.420
9.500	0.050	-63.310	0.940	-76.770	0.940	-76.770	0.064	-64.240
9.600	0.051	-62.050	0.939	-77.630	0.939	-77.630	0.064	-63.200
9.700	0.053	-60.350	0.939	-78.490	0.939	-78.490	0.065	-62.010
9.800	0.054	-59.300	0.938	-79.350	0.938	-79.350	0.066	-60.960
9.900	0.055	-57.990	0.938	-80.200	0.938	-80.200	0.067	-60.070
10.000	0.057	-56.400	0.937	-81.060	0.937	-81.060	0.068	-58.840

MADP-008120-12790T

Isolation @ -10V, 0mA in Single Series Diode Configuration, Z0 = 50 Ohms

F (GHz)	S11 Mag	S11 Ang	S21 Mag	S21 Ang	S12 Mag	S12 Ang	S22 Mag	S22 Ang
0.100	1.004	-1.290	0.008	86.770	0.008	86.770	0.995	-1.240
0.200	1.004	-2.610	0.015	86.680	0.015	86.680	0.997	-2.500
0.300	1.005	-3.970	0.023	85.550	0.023	85.550	0.996	-3.760
0.400	1.006	-5.310	0.031	84.170	0.031	84.170	0.995	-4.970
0.500	1.006	-6.600	0.039	82.860	0.039	82.860	0.995	-6.210
0.600	1.007	-7.970	0.046	81.610	0.046	81.610	0.994	-7.410
0.700	1.006	-9.290	0.054	80.220	0.054	80.220	0.993	-8.660
0.800	1.006	-10.630	0.061	79.000	0.061	79.000	0.993	-9.880
0.900	1.005	-11.980	0.069	77.790	0.069	77.790	0.992	-11.090
1.000	1.005	-13.270	0.076	76.530	0.076	76.530	0.993	-12.300
1.100	1.003	-14.610	0.084	75.230	0.084	75.230	0.993	-13.520
1.200	1.000	-15.920	0.091	73.910	0.091	73.910	0.992	-14.740
1.300	1.000	-17.180	0.099	72.610	0.099	72.610	0.992	-15.990
1.400	1.002	-18.470	0.106	71.270	0.106	71.270	0.994	-17.220
1.500	0.998	-19.780	0.113	70.000	0.113	70.000	0.988	-18.440
1.600	0.997	-21.070	0.120	68.650	0.120	68.650	0.987	-19.660
1.700	0.999	-22.520	0.127	67.400	0.127	67.400	0.987	-21.040
1.800	0.996	-23.660	0.134	66.170	0.134	66.170	0.983	-22.020
1.900	0.996	-24.990	0.141	64.940	0.141	64.940	0.982	

## Mounting Information

The illustration indicates the recommended mounting pad configuration for the SC-79 package. Solder paste containing flux should be screened onto the pads to a thickness of 0.005-0.007 inches. The plastic package is placed in position, firmly adhering to the solder paste.

Permanent attachment is performed by a reflow soldering procedure during which the tab temperature does not exceed +275 °C and the body temperature does not exceed +260 °C.

**Please refer to Application Note M538 for surface mounting instructions.**

## SC-79

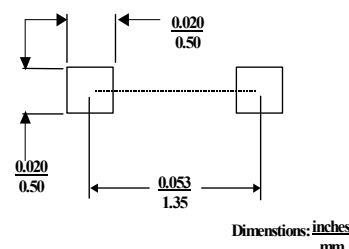

## Case Styles (Cont'd)

### SC-79

#### Case Style 1279

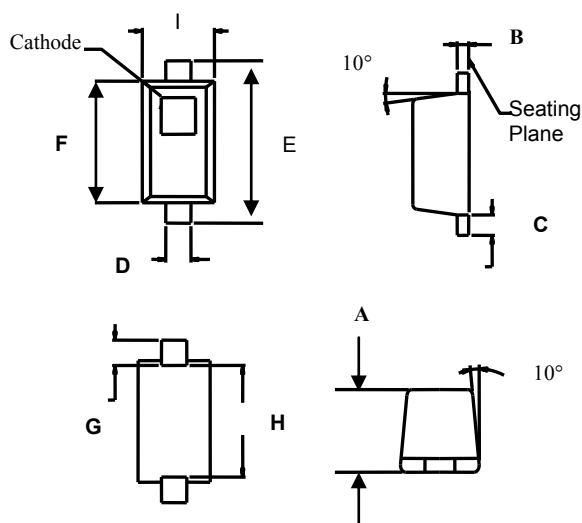

## SC-79 (Case Style 1279)

DIM.	INCHES		MILLIMETERS	
	MIN.	MAX.	MIN.	MAX.
A	0.020	0.028	0.51	0.71
B	0.003	0.008	0.08	0.20
C	0.006	0.010	0.15	0.25
D	0.010	0.014	0.25	0.36
E	0.059	0.067	1.50	1.70
F	0.043	0.051	1.09	1.30
G	0.011	0.012	0.28	0.30
H	0.037	0.043	0.94	1.09
I	0.027	0.035	0.69	0.89

M/A-COM Technology Solutions Inc. All rights reserved.

Information in this document is provided in connection with M/A-COM Technology Solutions Inc ("MACOM") products. These materials are provided by MACOM as a service to its customers and may be used for informational purposes only. Except as provided in MACOM's Terms and Conditions of Sale for such products or in any separate agreement related to this document, MACOM assumes no liability whatsoever. MACOM assumes no responsibility for errors or omissions in these materials. MACOM may make changes to specifications and product descriptions at any time, without notice. MACOM makes no commitment to update the information and shall have no responsibility whatsoever for conflicts or incompatibilities arising from future changes to its specifications and product descriptions. No license, express or implied, by estoppel or otherwise, to any intellectual property rights is granted by this document.

THESE MATERIALS ARE PROVIDED "AS IS" WITHOUT WARRANTY OF ANY KIND, EITHER EXPRESS OR IMPLIED, RELATING TO SALE AND/OR USE OF MACOM PRODUCTS INCLUDING LIABILITY OR WARRANTIES RELATING TO FITNESS FOR A PARTICULAR PURPOSE, CONSEQUENTIAL OR INCIDENTAL DAMAGES, MERCHANTABILITY, OR INFRINGEMENT OF ANY PATENT, COPYRIGHT OR OTHER INTELLECTUAL PROPERTY RIGHT. MACOM FURTHER DOES NOT WARRANT THE ACCURACY OR COMPLETENESS OF THE INFORMATION, TEXT, GRAPHICS OR OTHER ITEMS CONTAINED WITHIN THESE MATERIALS. MACOM SHALL NOT BE LIABLE FOR ANY SPECIAL, INDIRECT, INCIDENTAL, OR CONSEQUENTIAL DAMAGES, INCLUDING WITHOUT LIMITATION, LOST REVENUES OR LOST PROFITS, WHICH MAY RESULT FROM THE USE OF THESE MATERIALS.

MACOM products are not intended for use in medical, lifesaving or life sustaining applications. MACOM customers using or selling MACOM products for use in such applications do so at their own risk and agree to fully indemnify MACOM for any damages resulting from such improper use or sale.

## Looking for pricing, stock, or lifecycle information?

Click below to explore more details on WIN SOURCE:

- ⊖ [View MADP-008120-12790T on WIN SOURCE](#)
- ⊖ [M/A-Com Technology Solutions Information](#)

## Optimize Your Supply Chain with WIN SOURCE Solutions

- ✓ Global Sourcing Solution
- ✓ Obsolete Management
- ✓ Cost Control Management
- ✓ Shortage Management
- ✓ Alternative Solution
- ✓ Excess Inventory Management