



**THE DATASHEET OF
MAX1595EUA50+T**





Regulated 3.3V/5.0V Step-Up/Step-Down Charge Pump

MAX1595

General Description

The MAX1595 charge-pump regulator generates either 3.3V or 5V from a 1.8V to 5.5V input. The unique control architecture allows the regulator to step up or step down the input voltage to maintain output regulation. The 1MHz switching frequency, combined with a unique control scheme, allows the use of a ceramic capacitor as small as 1 μ F for 125mA of output current. The complete regulator requires three external capacitors—no inductor is needed. The MAX1595 is specifically designed to serve as a high-power, high-efficiency auxiliary supply in applications that demand a compact design. The MAX1595 is offered in space-saving 8-pin μ MAX[®] and high-power 12-pin TQFN packages.

Applications

White LED Power
Flash Memory Supplies
Battery-Powered Applications
Miniature Equipment
PCMCIA Cards
3.3V to 5V Local Conversion Applications
Backup-Battery Boost Converters
3V to 5V GSM SIMM Cards

μ MAX is a registered trademark of Maxim Integrated Products, Inc.

Typical Operating Circuit

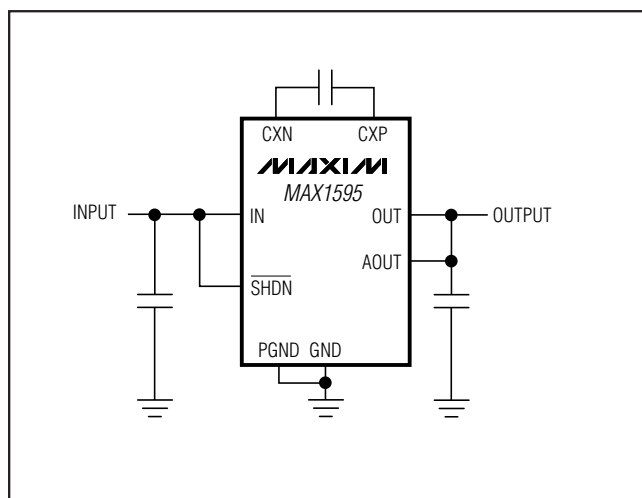

Features

- ◆ Ultra-Small: Requires Only Three Ceramic Capacitors
- ◆ No Inductors Required
- ◆ Up to 125mA Output Current
- ◆ Regulated $\pm 3\%$ Output Voltage
- ◆ 1MHz Switching Frequency
- ◆ 1.8V to 5.5V Input Voltage
- ◆ 220 μ A Quiescent Current
- ◆ 0.1 μ A Shutdown Current
- ◆ Load Disconnect in Shutdown

Ordering Information

PART	TEMP RANGE	PIN-PACKAGE
MAX1595EUA33+	-40°C to +85°C	8 μ MAX
MAX1595ETC33+	-40°C to +85°C	12 TQFN-EP*
MAX1595EUA50+	-40°C to +85°C	8 μ MAX
MAX1595ETC50+	-40°C to +85°C	12 TQFN-EP*

+Denotes a lead(Pb)-free/RoHS-compliant package.

*EP = Exposed pad.

Selector Guide

PART	V _{OUT} (V)**	TOP MARK
MAX1595EUA33+	3.3	—
MAX1595ETC33+	3.3	AAEH
MAX1595EUA50+	5.0	—
MAX1595ETC50+	5.0	AAEI

**Contact factory for other fixed-output voltages from 2.7V to 5.0V.

Pin Configurations

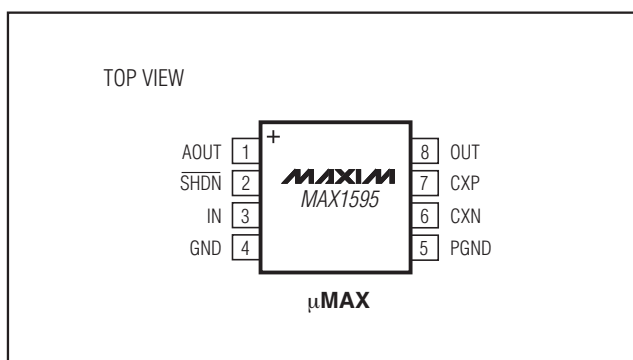

Pin Configurations continued at end of data sheet.



Maxim Integrated Products

For pricing, delivery, and ordering information, please contact Maxim Direct at 1-888-629-4642, or visit Maxim's website at www.maxim-ic.com.

Regulated 3.3V/5.0V Step-Up/ Step-Down Charge Pump

ABSOLUTE MAXIMUM RATINGS

IN, OUT, AOUT to GND	-0.3V to +6V	Continuous Power Dissipation ($T_A = +70^\circ\text{C}$)	
SHDN to PGND	-0.3V to +6V	μMAX (derate 4.8mW/ $^\circ\text{C}$ above $+70^\circ\text{C}$)	387.8mW
PGND to GND	-0.3V to +0.3V	TQFN-EP (derate 24.4mW/ $^\circ\text{C}$ above $+70^\circ\text{C}$)	1951.2mW
CXN to PGND	-0.3V to (Lower of IN + 0.8V or 6.3V)	Operating Temperature Range	-40°C to $+85^\circ\text{C}$
CXP to GND	-0.8V to (Higher of OUT + 0.8V or IN + 0.8V but not greater than 6V)	Junction Temperature	$+150^\circ\text{C}$
Continuous Output Current	150mA	Storage Temperature Range	-65°C to $+150^\circ\text{C}$
		Lead Temperature (soldering, 10s)	$+300^\circ\text{C}$
		Soldering Temperature (reflow)	$+260^\circ\text{C}$

Stresses beyond those listed under "Absolute Maximum Ratings" may cause permanent damage to the device. These are stress ratings only, and functional operation of the device at these or any other conditions beyond those indicated in the operational sections of the specifications is not implied. Exposure to absolute maximum rating conditions for extended periods may affect device reliability.

PACKAGE THERMAL CHARACTERISTICS (Note 1)

TQFN	Junction-to-Ambient Thermal Resistance (θ_{JA})	$41^\circ\text{C}/\text{W}$	μMAX	Junction-to-Ambient Thermal Resistance (θ_{JA})	$206.3^\circ\text{C}/\text{W}$
	Junction-to-Case Thermal Resistance (θ_{JC})	$6^\circ\text{C}/\text{W}$		Junction-to-Case Thermal Resistance (θ_{JC})	$42^\circ\text{C}/\text{W}$

Note 1: Package thermal resistances were obtained using the method described in JEDEC specification JESD51-7, using a four-layer board. For detailed information on package thermal considerations, refer to www.maxim-ic.com/thermal-tutorial.

ELECTRICAL CHARACTERISTICS

($V_{IN} = 2\text{V}$ for MAX1595_ _33, $V_{IN} = 3\text{V}$ for MAX1595_ _50, $C_{IN} = 1\mu\text{F}$, $C_X = 0.22\mu\text{F}$, $C_{OUT} = 1\mu\text{F}$, $T_A = -40^\circ$ to $+85^\circ\text{C}$, unless otherwise noted. Typical values are at $T_A = +25^\circ\text{C}$.) (Note 2)

PARAMETER	SYMBOL	CONDITIONS	MIN	TYP	MAX	UNITS	
Input Voltage Range	V_{IN}		1.8		5.5	V	
Input Undervoltage Lockout Threshold			1.40	1.60	1.72	V	
Input Undervoltage Lockout Hysteresis				40		mV	
Output Voltage	V_{OUT}	$0 < I_{LOAD} < 125\text{mA}$, $V_{IN} = +3.0\text{V}$	$T_A = 0^\circ\text{C}$ to $+85^\circ\text{C}$	4.85	5.05	5.15	V
			$T_A = -40^\circ\text{C}$ to $+85^\circ\text{C}$	4.80		5.20	
		$0 < I_{LOAD} < 75\text{mA}$, $V_{IN} = +2.0\text{V}$	$T_A = 0^\circ\text{C}$ to $+85^\circ\text{C}$	3.20	3.33	3.40	
			$T_A = -40^\circ\text{C}$ to $+85^\circ\text{C}$	3.16		3.44	
No-Load Input Current	I_Q	$V_{IN} = +2.0\text{V}$, MAX1595_ _33		220	320	μA	
		$V_{IN} = +3.0\text{V}$, MAX1595_ _50		240	350		
Switching Frequency	f_{OSC}	$I_{LOAD} > 20\text{mA}$, $V_{OUT} > V_{IN}$	0.85	1.0	1.15	MHz	
Shutdown Supply Current	I_{SHDN}	$V_{SHDN} = 0\text{V}$, $V_{IN} = +5.5\text{V}$, $V_{OUT} = 0\text{V}$			5	μA	
SHDN Input Voltage Low	V_{INL}	$V_{IN} = 2.0\text{V}$ to 5.5V			0.6	V	
SHDN Input Voltage High	V_{INH}	$V_{IN} = 2.0\text{V}$ to 5.5V	1.6			V	
SHDN Input Leakage Current					0.1	μA	

Note 2: Specifications to -40°C are guaranteed by design, not production tested.

Regulated 3.3V/5.0V Step-Up/Step-Down Charge Pump

MAX1595

Typical Operating Characteristics

(Circuit of Figure 4, $V_{IN} = 2V$ for MAX1595__33, $V_{IN} = 3V$ for MAX1595__50, $T_A = +25^\circ C$, unless otherwise noted.)

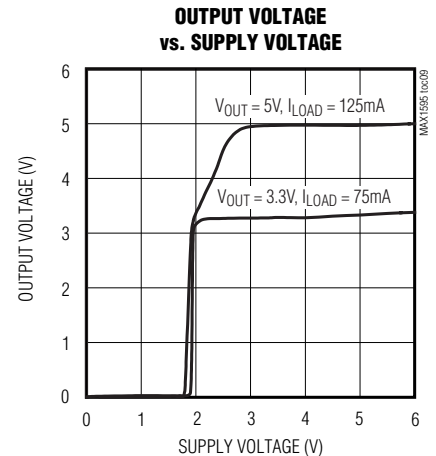
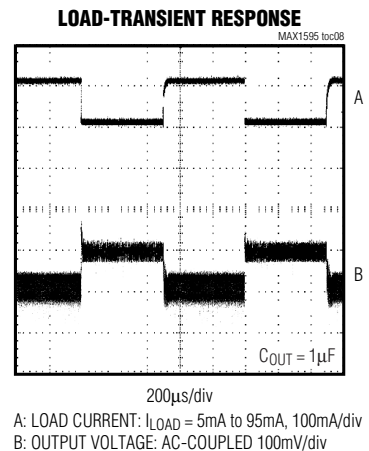
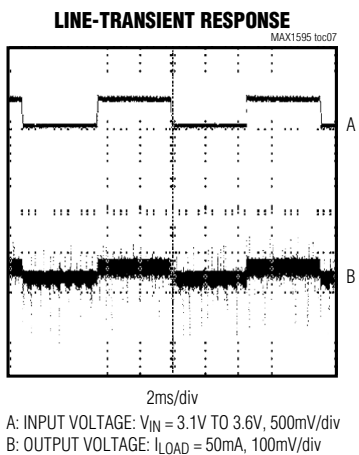
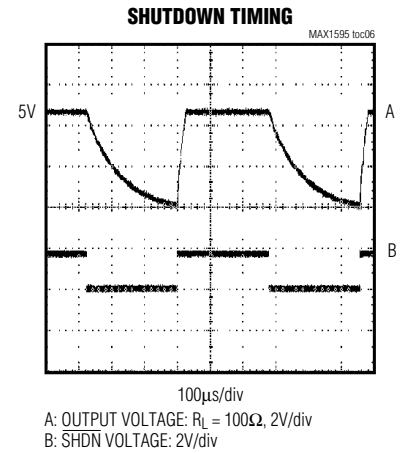
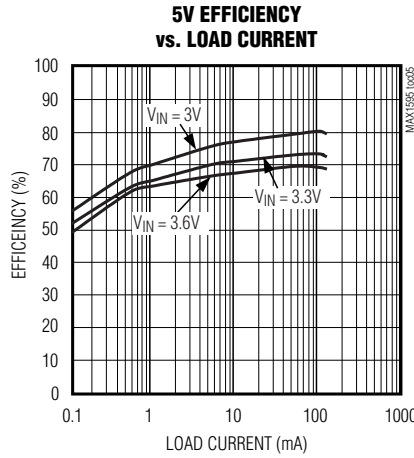
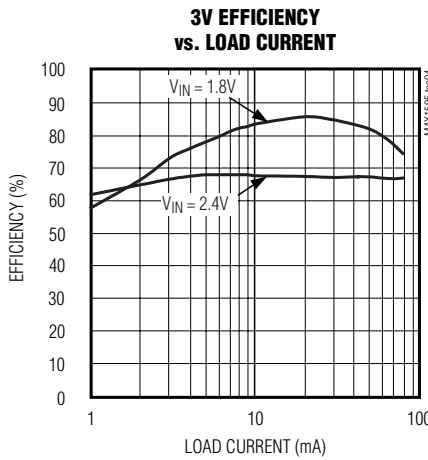
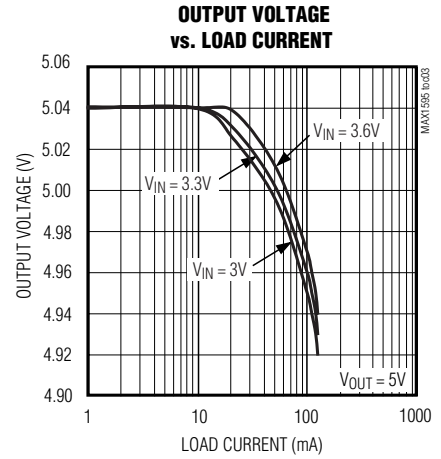
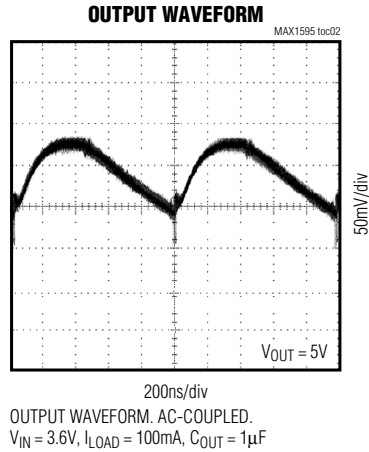
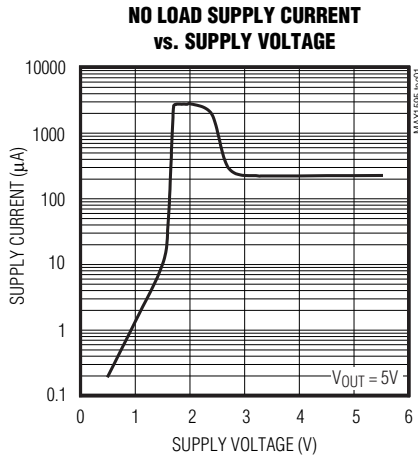

Regulated 3.3V/5.0V Step-Up/ Step-Down Charge Pump

Pin Description

PIN		NAME	FUNCTION
μ MAX	TQFN-EP		
1	12	AOUT	Analog Power and Sense Input for Error Amplifier/Comparator. Connect to OUT at output filter capacitor.
2	1	$\overline{\text{SHDN}}$	Shutdown Input. When $\overline{\text{SHDN}}$ = low, the device turns off; when $\overline{\text{SHDN}}$ = high, the device activates. In shutdown, OUT is disconnected from IN.
3	2, 3	IN	Input Supply. Can range from 1.8V to 5.5V. Bypass to GND with a 1 μ F capacitor.
4	4	GND	Ground
5	5, 6	PGND	Power Ground
6	7, 8	CXN	Negative Terminal of the Charge-Pump Transfer Capacitor
7	9	CXP	Positive Terminal of the Charge-Pump Transfer Capacitor
8	10, 11	OUT	Output. Bypass to GND with output capacitor filter.
—	—	EP	Exposed Pad. Internally connected to GND. Connect to a large ground plane to maximize thermal performance. Not intended as an electrical connection point (TQFN package only).

Detailed Description

The MAX1595 charge pump provides either a 3.3V or 5V regulated output. It delivers a maximum 125mA load current. In addition to boost regulating from a lower supply, it is also capable of buck regulating from supplies that exceed the regulated output by a diode drop or more. Designed specifically for compact applications, a complete regulator circuit requires only three small external capacitors. An innovative control scheme provides constant frequency operation from medium to heavy loads, while smoothly transitioning to low-power mode at light loads to maintain optimum efficiency. In buck mode, switch S1 (Figure 1) is switched continuously to IN, while switch S2 alternates between IN and OUT. An amount of charge proportional to the difference between the output voltage and the supply voltage is stored on C_X , which gets transferred to the output when the regulation point is reached. Maximum output ripple is proportional to the difference between the supply voltage and the output voltage, as well as to the ratio of the transfer capacitor (C_X) to the output capacitor (C_{OUT}).

The MAX1595 consists of an error amplifier, a 1.23V bandgap reference, internal resistive feedback network, oscillator, high-current MOSFET switches, and shutdown and control logic. Figure 1 shows an idealized unregulated charge-pump voltage doubler. The oscillator runs at a 50% duty cycle. During one half of the period, the transfer capacitor (C_X) charges to the input voltage. During the other half, the doubler transfers the sum of C_X and input voltage to the output filter capacitor (C_{OUT}). Rather

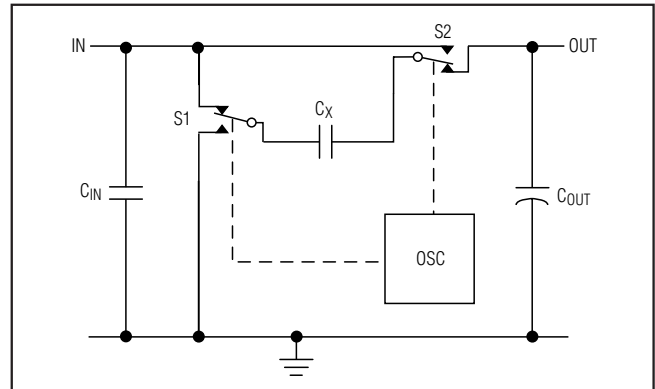

Figure 1. Unregulated Voltage Doubler

than doubling the input voltage, the MAX1595 provides a regulated output voltage of either 3.3V or 5.0V.

Shutdown

Driving $\overline{\text{SHDN}}$ low places the device in shutdown mode. The device draws 0.1 μ A of supply current in this mode. When driven high, the MAX1595 enters a soft-start mode. Soft-start mode terminates when the output voltage regulates, or after 2ms, whichever comes first. In shutdown, the output disconnects from the input.

Undervoltage Lockout

The MAX1595 has an undervoltage-lockout that deactivates the devices when the input voltage falls below 1.6V. Below UVLO, hysteresis holds the device in shutdown until the input voltage rises 40mV above the lockout threshold.

Regulated 3.3V/5.0V Step-Up/Step-Down Charge Pump

MAX1595

Applications Information

Using white LEDs to backlight LCDs is an increasingly popular approach for portable information devices (Figure 2). Because the forward voltage of white LEDs exceeds the available battery voltage, the use of a charge pump such as the MAX1595 provides high efficiency, small size, and constant light output with changing battery voltages. If the output is used only to light LEDs, the output capacitor can be greatly reduced. The frequency modulation of the LED intensity is not discernible to the human eye, and the smaller capacitor saves both size and cost.

Adding two Schottky diodes and two capacitors implements a tripler and allows the MAX1595_50 to regulate a current of 75mA with a supply voltage as low as 2.3V (Figure 3).

Capacitor Selection

The MAX1595 requires only three external capacitors (Figure 4). Their values are closely linked to the output current capacity, oscillator frequency, output noise content, and mode of operation.

Generally, the transfer capacitor (C_X) will be the smallest, and the input capacitor (C_{IN}) is twice as large as C_X . Higher switching frequencies allow the use of the smaller C_X and C_{IN} . The output capacitor (C_{OUT}) can be anywhere from 5-times to 50-times larger than C_X . Table 1 shows recommended capacitor values.

In addition, the following equation approximates output ripple:

$$V_{RIPPLE} \approx I_{OUT} / (2 \times f_{OSC} \times C_{OUT})$$

Table 2 lists the manufacturers of recommended capacitors. Ceramic capacitors will provide the lowest ripple due to their typically lower ESR.

Power Dissipation

The power dissipated in the MAX1595 depends on output current and is accurately described by:

$$P_{DISS} = I_{OUT} (2V_{IN} - V_{OUT})$$

P_{DISS} must be less than that allowed by the package rating.

Layout Considerations

All capacitors should be soldered in close proximity to the IC. Connect ground and power ground through a short, low-impedance trace. The input supply trace should be as short as possible. Otherwise, an additional input supply filter capacitor (tantalum or electrolytic) may be required.

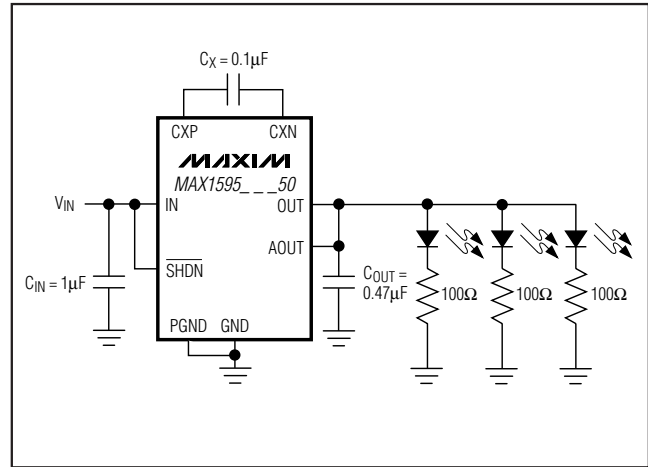

Figure 2. White LED Bias Supply

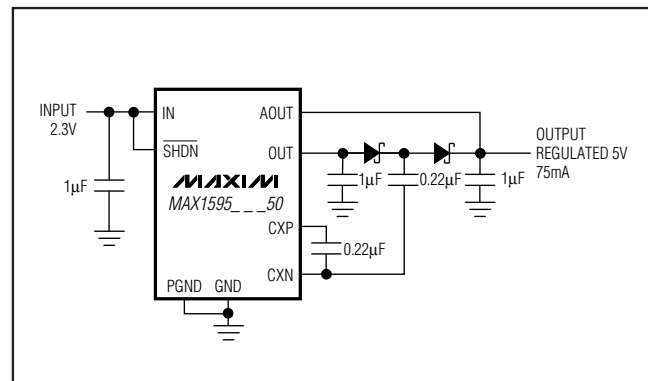

Figure 3. Regulated Voltage Tripler

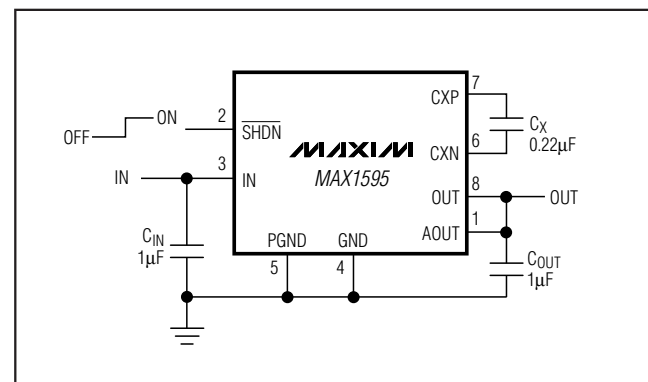

Figure 4. Standard Operating Circuit

Regulated 3.3V/5.0V Step-Up/ Step-Down Charge Pump

Table 1. Recommended Capacitor Values

OUTPUT RIPPLE (mV)	C _{IN} (μF)	C _X (μF)	C _{OUT} (μF)
70	1	0.22	1
35	2.2	0.47	2.2

Table 2. Recommended Capacitor Manufacturers

VALUE (μF)	VOLTAGE (V)	TYPE	SIZE	MANUFACTURER	PART
1	10	X7R	0805	Taiyo Yuden	LMK212BJ105MG
0.22	10	X7R	0603	Taiyo Yuden	LMK107BJ224MA
0.47	10	X7R	0603	Taiyo Yuden	LMK107BJ474MA
0.1	10	X7R	0603	Taiyo Yuden	LMK107BJ104MA

Pin Configurations (continued)

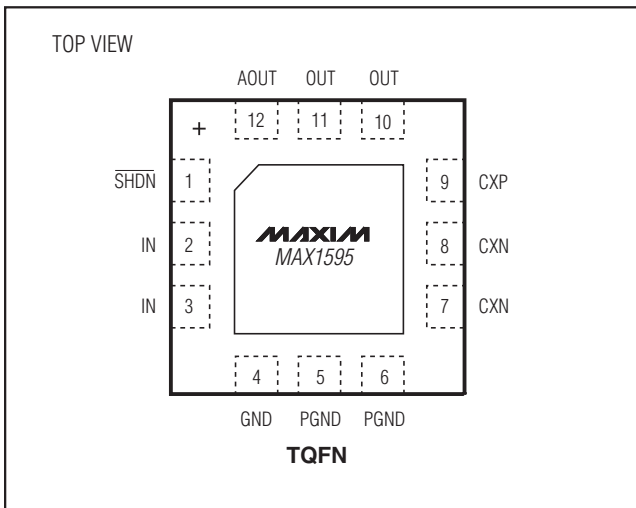

Chip Information

PROCESS: CMOS

Package Information

For the latest package outline information and land patterns (footprints), go to www.maxim-ic.com/packages. Note that a "+", "#", or "-" in the package code indicates RoHS status only. Package drawings may show a different suffix character, but the drawing pertains to the package regardless of RoHS status.

PACKAGE TYPE	PACKAGE CODE	OUTLINE NO.	LAND PATTERN NO.
8 μMAX	U8+1	21-0036	90-0092
12 TQFN	1244+4	21-0139	90-0068

Regulated 3.3V/5.0V Step-Up/Down Charge Pump

Revision History

REVISION NUMBER	REVISION DATE	DESCRIPTION	PAGES CHANGED
2	6/09	Added EP (exposed pad) and top mark information	1, 2, 4, 6
3	10/11	Updated <i>Absolute Maximum Ratings</i> section and added <i>Package Thermal Characteristics</i> section	2

MAX1595

Maxim cannot assume responsibility for use of any circuitry other than circuitry entirely embodied in a Maxim product. No circuit patent licenses are implied. Maxim reserves the right to change the circuitry and specifications without notice at any time. The parametric values (min and max limits) shown in the Electrical Characteristics table are guaranteed. Other parametric values quoted in this data sheet are provided for guidance.

Maxim Integrated Products, 120 San Gabriel Drive, Sunnyvale, CA 94086 408-737-7600 _____ 7

Looking for pricing, stock, or lifecycle information?

Click below to explore more details on WIN SOURCE:

- ⊖ [View MAX1595EUA50+T on WIN SOURCE](#)
- ⊖ [Maxim Integrated Information](#)

Optimize Your Supply Chain with WIN SOURCE Solutions

- ✓ Global Sourcing Solution
- ✓ Obsolete Management
- ✓ Cost Control Management
- ✓ Shortage Management
- ✓ Alternative Solution
- ✓ Excess Inventory Management