



**THE DATASHEET OF
MAX1838EEE+T**





Dual USB Switch with Fault Blanking and Autoreset

MAX1838

General Description

The MAX1838 is a dual, current-limited USB switch with auxiliary input supply. Each switch meets all IEC specifications for USB ports and is guaranteed to supply 500mA from either of two input supplies. A control pin selects the power source from either the main or auxiliary supply.

The MAX1838 has multiple protection features, including independent thermal-shutdown on each channel to limit junction temperature in case of a prolonged short or overload condition. The device has accurate internal current-limit and reverse-current protection to safeguard the input supply against overload. When powered from the auxiliary supply, the current limit on each channel is set independently with an external resistor.

An autoreset feature latches the switch off if the output is shorted, thereby saving system power. When the short is removed, the switch automatically turns back on. Independent fault signals (FAULTA and FAULTB) notify the microprocessor (μ P) that the internal current limit has been reached. A 20ms fault-blanking feature prevents the MAX1838 from issuing false alarms to the host during power-up or when hot-swapping into a capacitive load.

The MAX1838 is available in a space-saving 16-pin QSOP. For other USB current-limited switches, refer to the MAX1693, MAX1694, MAX1812, and MAX1823.

Applications

Desktops
Notebook Computers
USB Ports
Docking Stations

Pin Configuration

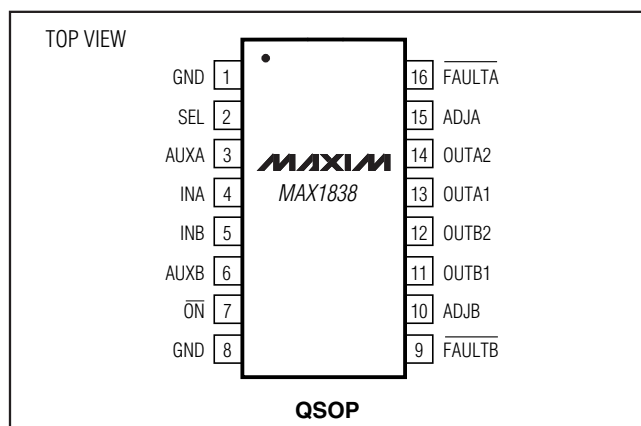

Features

- ◆ Dual USB Switch with Auxiliary Input
- ◆ Autoreset from Fault Condition
- ◆ Guaranteed 500mA Load per Channel
- ◆ Programmable Current Limits on Auxiliary Inputs
- ◆ Reverse Current Protection
- ◆ Thermal Overload Protection
- ◆ Built-In 20ms Fault-Blanking
- ◆ 4V to 5.5V Range
- ◆ Independent FAULT Indicator Outputs

Ordering Information

PART	TEMP RANGE	PIN-PACKAGE
MAX1838EEE	-40°C to +85°C	16 QSOP

Typical Operating Circuit

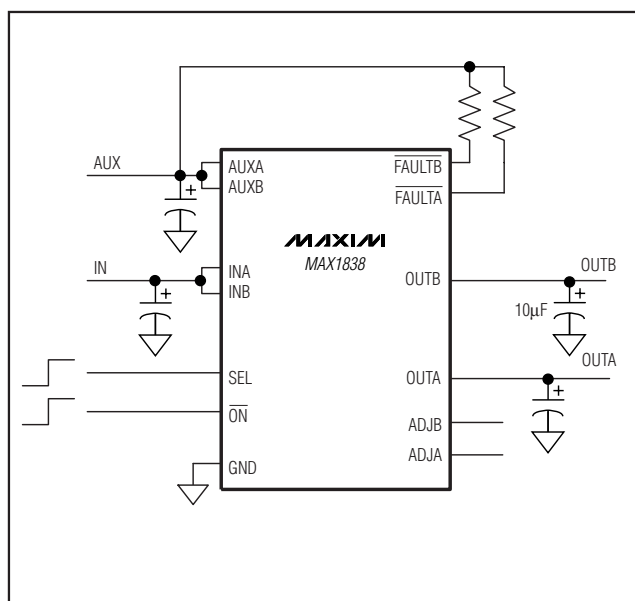

Dual USB Switch with Fault Blanking and Autoreset

ABSOLUTE MAXIMUM RATINGS

IN ₋ , AUX ₋ , $\overline{\text{ON}}$, OUT ₋ , SEL, FAULT ₋ , ADJ ₋ to GND.....	-0.3V to +6V	Operating Temperature Range	-40°C to +85°C
IN ₋ , AUX ₋ to OUTA ₋ ; IN ₋ , AUX ₋ to OUTB ₋	-6V to +6V	Junction Temperature	+150°C
AUX ₋ to IN ₋	-6V to +6V	Storage Temperature Range	-65°C to +150°C
Maximum Continuous Switch Current (per channel, internally limited).....	1.2A	Lead Temperature (soldering, 10s)	+300°C
FAULT ₋ Current	20mA		
Continuous Power Dissipation (T _A = +70°C) 16-Pin QSOB (derate 8.3mW/°C above +70°C).....	667mW		

Stresses beyond those listed under "Absolute Maximum Ratings" may cause permanent damage to the device. These are stress ratings only, and functional operation of the device at these or any other conditions beyond those indicated in the operational sections of the specifications is not implied. Exposure to absolute maximum rating conditions for extended periods may affect device reliability.

ELECTRICAL CHARACTERISTICS

(V_{IN-} = V_{AUX-} = 5V, $\overline{\text{ON}}$ = SEL = GND, ADJ₋ = open, T_A = 0°C to +85°C, unless otherwise noted. Typical values are at T_A = +25°C.)

PARAMETER	SYMBOL	CONDITIONS	MIN	TYP	MAX	UNITS	
Supply Voltage Range	V _{IN-}		4.0		5.5	V	
	V _{AUX-}		4.0		5.5		
Switch On-Resistance	R _{ON}	V _{IN-} = 5V, each switch		95	170	mΩ	
		V _{IN-} = 4V, each switch		100			
AUX ₋ Standby Supply Current		V $\overline{\text{ON}}$ = V _{AUX-}		7	16	μA	
IN ₋ Standby Supply Current		V $\overline{\text{ON}}$ = V _{IN-}		1	3	μA	
AUX ₋ Quiescent Supply Current		V $\overline{\text{ON}}$ = 0V, I _{OUT-} = 0A		66	350	μA	
IN ₋ Quiescent Supply Current		V $\overline{\text{ON}}$ = 0V, I _{OUT-} = 0A, SEL = AUX ₋		23	300	μA	
OUT ₋ Off-Leakage Current		V $\overline{\text{ON}}$ = V _{IN-} , V _{OUTA-} = V _{OUTB-} = 0V		0.02	10	μA	
Reverse Leakage Current		V _{OUT-} = 5.5V, V _{IN-} = V _{AUX-} = 0V		0.02	10	μA	
Undervoltage Lockout Threshold	V _{UVLO}	V _{IN-} or V _{AUX-} rising edge, 3% hysteresis	3.0	3.5	3.8	V	
Continuous Load Current			500			mA	
Current-Limit Threshold	I _{LIM}	V _{IN-} - V _{OUT-} = 0.5V, SEL = AUX ₋	0.6	0.9	1.2	A	
		V _{AUX-} - V _{OUT-} = 0.5V, SEL = GND	0.6	0.9	1.2		
		R _{ADJ-} = 67kΩ	0.09	0.225	0.36		
Short-Circuit Current Limit	I _{SHORT}	SEL = GND, V _{OUT-} = 0V (I _{OUT-} pulsing)	R _{ADJ-} = 67kΩ		0.3	0.48	A _{PEAK}
					0.09		A _{RMS}
		SEL = AUX ₋ , V _{OUT-} = 0V		0.6	1.2	1.8	A _{PEAK}
						0.35	
Continuous Current-Limit Blanking Timeout Period		From continuous current-limit condition to $\overline{\text{FAULT}}$ assertion	10	20	35	ms	
Short-Circuit Blanking Timeout Period		From short-circuit current-limit condition to $\overline{\text{FAULT}}$ assertion	7.5	18	35	ms	

Dual USB Switch with Fault Blanking and Autoreset

MAX1838

ELECTRICAL CHARACTERISTICS (continued)

($V_{IN_} = V_{AUX_} = 5V$, $\overline{ON} = SEL = GND$, $ADJ_ = open$, $T_A = 0^{\circ}C$ to $+85^{\circ}C$, unless otherwise noted. Typical values are at $T_A = +25^{\circ}C$.)

PARAMETER	SYMBOL	CONDITIONS	MIN	TYP	MAX	UNITS
Turn-On Delay		$R_{OUT_} = 10\Omega$, does not include rise time (from \overline{ON} asserted to $V_{OUT_} = 10\%$ of $V_{IN_}$), $C_{OUT_} = 1\mu F$	0.5	2	4.0	ms
Output Rise Time		$R_{OUT_} = 10\Omega$, from 10% to 90% of $V_{OUT_}$, $C_{OUT_} = 1\mu F$		4.5		ms
Turn-Off Delay from ON		$R_{OUT_} = 10\Omega$, does not include fall time (from \overline{ON} asserted to $V_{OUT_} = 90\%$ of $V_{IN_}$), $C_{OUT_} = 1\mu F$		0.8	3	ms
Output Fall Time		$R_{OUT_} = 10\Omega$, from 90% to 10% of $V_{OUT_}$, $C_{OUT_} = 1\mu F$		3		ms
Thermal Shutdown Threshold		$10^{\circ}C$ hysteresis		160		$^{\circ}C$
Logic Input High Voltage		$V_{IN_} = 4V$ to $5.5V$	2			V
Logic Input Low Voltage		$V_{IN_} = 4V$ to $5.5V$			0.8	V
Logic Input Current		$V_{\overline{ON}} = 0V$ or $5.5V$	-1		1	μA
$\overline{FAULT_}$ Output Low Voltage		$V_{IN_} = 4V$, sinking 1mA			0.4	V
$\overline{FAULT_}$ Output High Leakage Current		$V_{IN_} = V_{\overline{FAULT_}} = 5.5V$			1	μA
Autoreset Current		In latched-off state, $V_{OUT_} = 0V$	10	25	50	mA
Autoreset Threshold		In latched-off state, $V_{OUT_}$ rising	0.4	0.5	0.6	V
Autoreset Blanking Time		In latched-off state, $V_{OUT_} > 1V$	10	20	35	ms
AUX_ to IN_ or IN_ to AUX_ Select Delay		Make-before-break (Note 1)	4.5	9	18	ms

ELECTRICAL CHARACTERISTICS

($V_{IN_} = V_{AUX_} = V_{\overline{ON}} = 5V$, $SEL = GND$, $ADJ_ = open$, $T_A = -40^{\circ}C$ to $+85^{\circ}C$, unless otherwise noted. Circuit of Figure 1.) (Note 2)

PARAMETER	SYMBOL	CONDITIONS	MIN	MAX	UNITS
Supply Voltage Range	$V_{IN_}$		4.0	5.5	V
	$V_{AUX_}$		4.0	5.5	V
Switch On-Resistance	R_{ON}	$V_{IN_} = 5V$, each switch		170	$m\Omega$
AUX_ Standby Supply Current		$V_{\overline{ON}} = V_{AUX_}$		16	μA
IN_ Standby Supply Current		$V_{\overline{ON}} = V_{IN_}$		3	μA
AUX_ Quiescent Supply Current		$V_{\overline{ON}} = 0V$, $I_{OUT_} = 0A$		350	μA
IN_ Quiescent Supply Current		$V_{\overline{ON}} = 0V$, $I_{OUT_} = 0A$, $SEL = AUX_$		300	μA
OUT_ Off-Leakage Current		$V_{\overline{ON}} = V_{IN_}$, $V_{OUTA_} = V_{OUTB_} = 0V$		10	μA
Reverse Leakage Current		$V_{OUT_} = 5.5V$, $V_{IN_} = V_{AUX_} = 0V$		10	μA
Undervoltage Lockout Threshold	V_{UVLO}	$V_{IN_}$ or $V_{AUX_}$ rising edge, 3% hysteresis	3.0	3.8	V
Continuous Load Current			500		mA

Dual USB Switch with Fault Blanking and Autoreset

ELECTRICAL CHARACTERISTICS (continued)

($V_{IN_} = V_{AUX_} = V_{\overline{ON}} = 5V$, $SEL = GND$, $ADJ_ = open$, $T_A = -40^{\circ}C$ to $+85^{\circ}C$, unless otherwise noted. Circuit of Figure 1.) (Note 2)

PARAMETER	SYMBOL	CONDITIONS	MIN	MAX	UNITS
Current-Limit Threshold	I_{LIM}	$V_{IN_} - V_{OUT_} = 0.5V$, $SEL = AUX_$	0.6	1.2	A
		$V_{AUX_} - V_{OUT_} = 0.5V$, $SEL = GND$	0.6	1.2	
Short-Circuit Current Limit	I_{SHORT}	$SEL = GND$, $V_{OUT_} = 0V$ ($I_{OUT_}$ pulsing)	0.6	1.8	A_{PEAK}
		$SEL = AUX_$, $V_{OUT_} = 0V$	0.6	1.8	
Continuous Current-Limit Blanking Timeout Period		From continuous current-limit condition to $\overline{FAULT_}$ assertion	9	40	ms
Short-Circuit Blanking Timeout Period		From short-circuit current-limit condition to $\overline{FAULT_}$ assertion	7	40	ms
Turn-On Delay		$R_{OUT_} = 10\Omega$, does not include rise time (from \overline{ON} asserted to $V_{OUT_} = 10\%$ of $V_{IN_}$), $C_{OUT_} = 1\mu F$	0.5	4	ms
Turn-Off Delay from ON		$R_{OUT_} = 10\Omega$, does not include fall time (from \overline{ON} asserted to $V_{OUT_} = 90\%$ of $V_{IN_}$), $C_{OUT_} = 1\mu F$		3	ms
Logic Input High Voltage		$V_{IN_} = 4V$ to $5.5V$	2		V
Logic Input Low Voltage		$V_{IN_} = 4V$ to $5.5V$		0.8	V
Logic Input Current		$V_{\overline{ON}} = 0V$ or $5.5V$	-1	1	μA
$\overline{FAULT_}$ Output Low Voltage		$V_{IN_} = 4V$, sinking $1mA$		0.4	V
$\overline{FAULT_}$ Output High Leakage Current		$V_{IN_} = V_{\overline{FAULT_}} = 5.5V$		1	μA
Autoreset Current		In latched-off state, $V_{OUT_} = 0V$	10	55	mA
Autoreset Threshold		In latched-off state, $V_{OUT_}$ rising	0.4	0.6	V
Autoreset Blanking Time		In latched-off state, $V_{OUT_} > 1V$	9	40	ms
AUX_ to IN_ or IN_ to AUX_ Select Delay		Make-before-break (Note 1)	4.5	18	ms

Note 1: SEL delay includes both make and break delay. The host system should wait for at least this interval before turning off the appropriate input supply.

Note 2: Specifications from $0^{\circ}C$ to $-40^{\circ}C$ are guaranteed by design, not production tested.

Dual USB Switch with Fault Blanking and Autoreset

Typical Operating Characteristics

(Circuit of Figure 2, $V_{IN_} = 5V$, $T_A = +25^\circ C$, unless otherwise noted.)

MAX1838

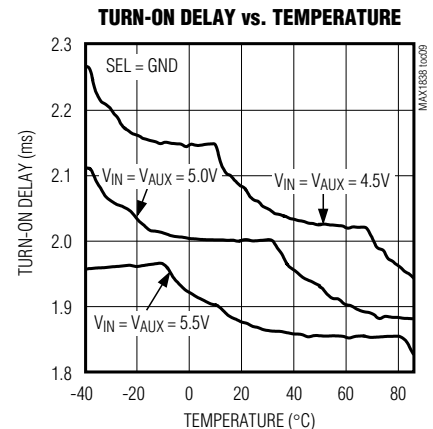
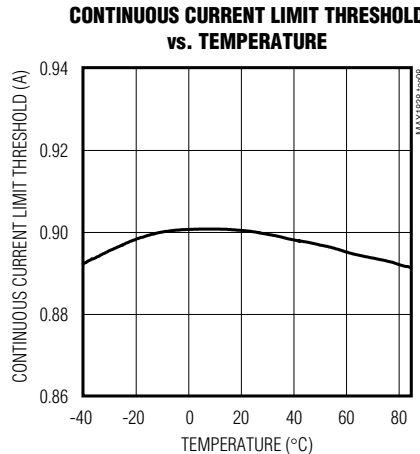
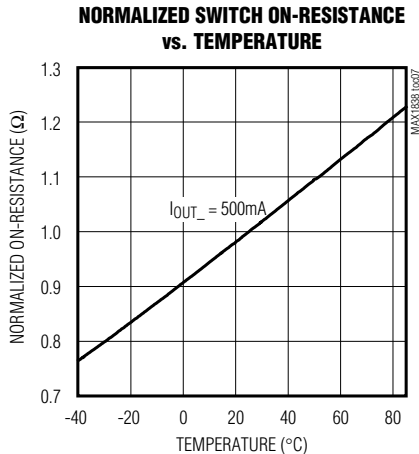
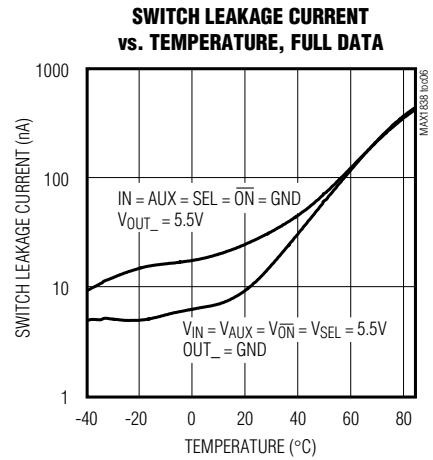
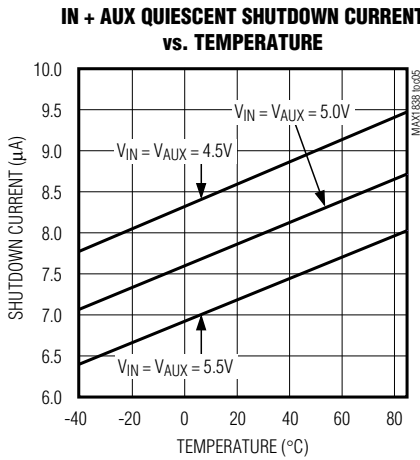
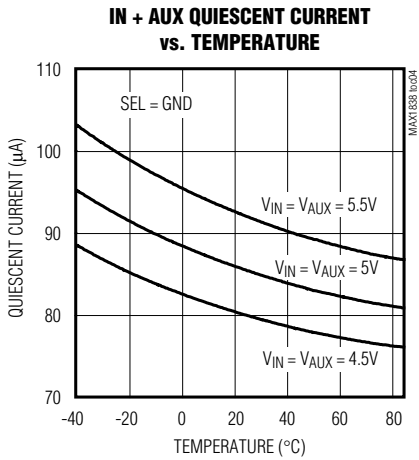
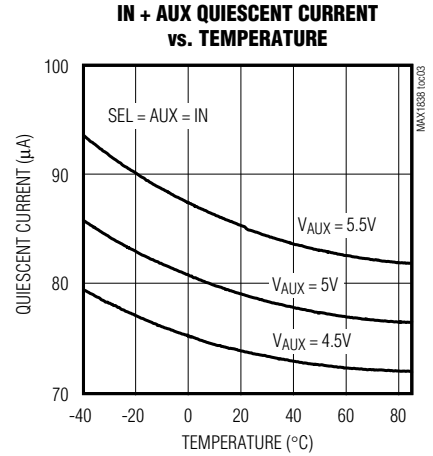
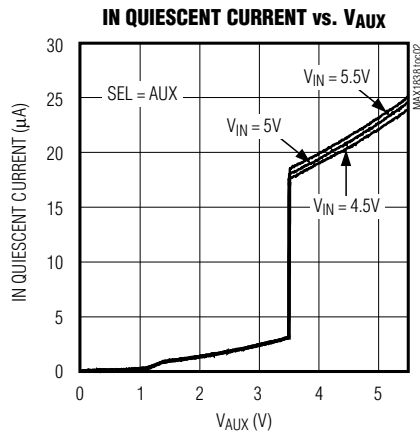
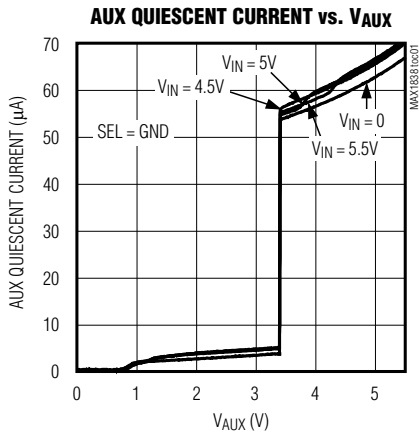

Dual USB Switch with Fault Blanking and Autoreset

Typical Operating Characteristics (continued)

(Circuit of Figure 2, $V_{IN_} = 5V$, $T_A = +25^\circ C$, unless otherwise noted.)

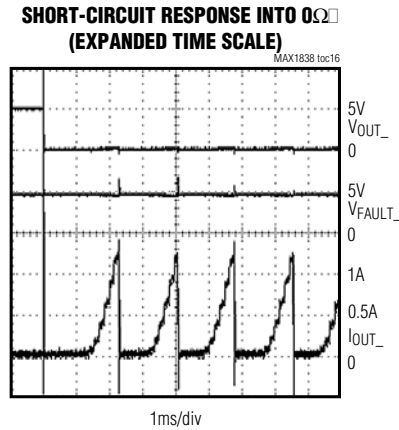
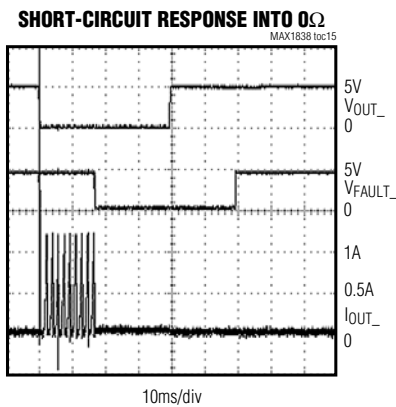
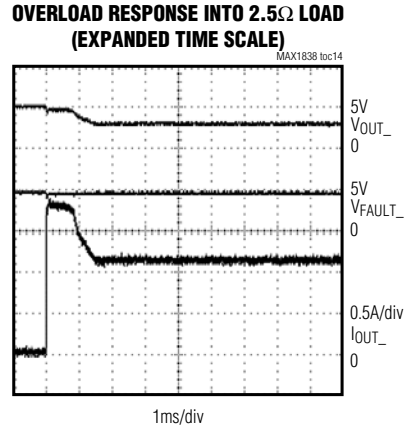
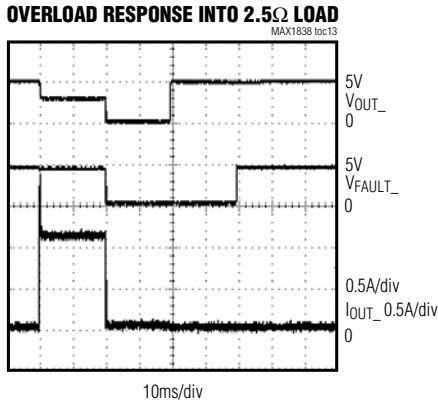
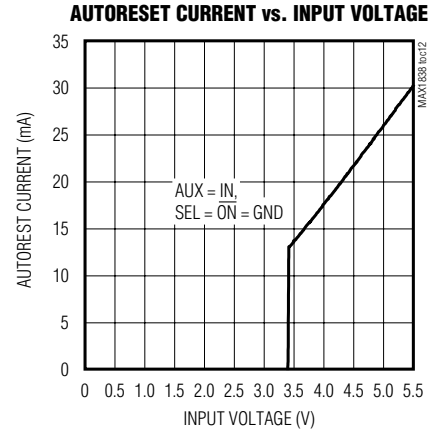
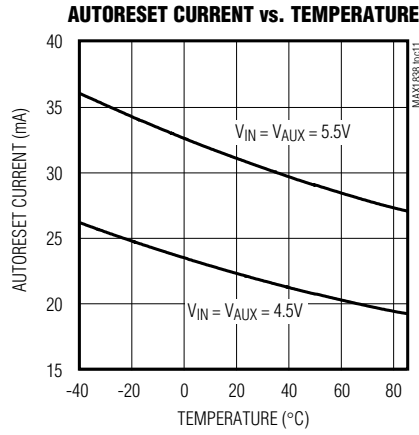
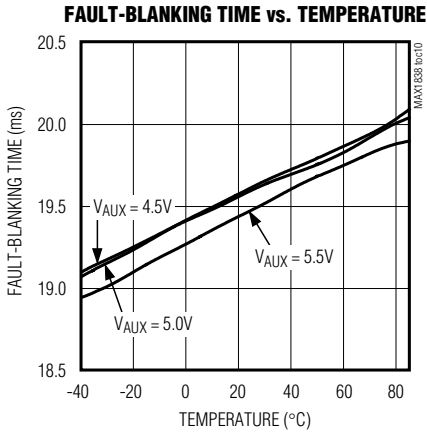

Dual USB Switch with Fault Blanking and Autoreset

MAX1838

Typical Operating Characteristics (continued)

(Circuit of Figure 2, $V_{IN_} = 5V$, $T_A = +25^\circ C$, unless otherwise noted.)

SWITCH TURN-ON TIME, $C_{OUT} = 1\mu F$

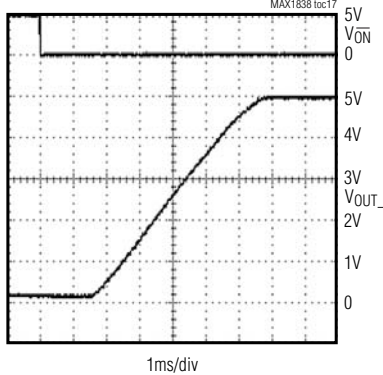

SWITCH TURN-OFF TIME, $C_{OUT} = 1\mu F$ $R_{OUT} = 10\Omega$

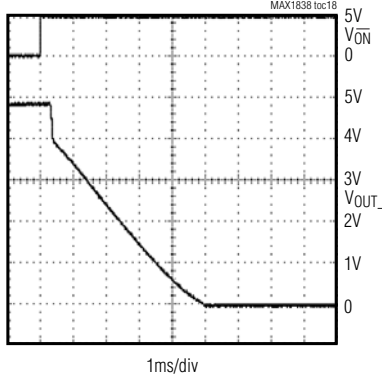

START-UP TIME INTO 10Ω LOAD

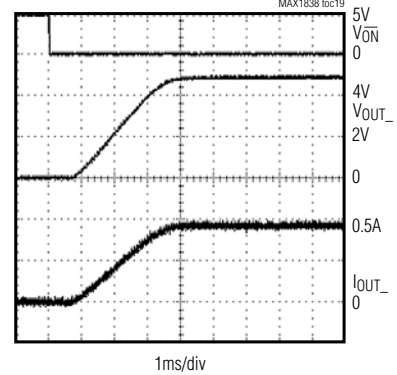

Pin Description

PIN	NAME	FUNCTION
1, 8	GND	Ground. Connect both GND pins together.
2	SEL	Select Input. Control input to select from either $V_{IN_}$ or $V_{AUX_}$ for both outputs. Pull SEL high for power from IN source, low for power from AUX source.
3, 6	AUXA, AUXB	Auxiliary Input. Connect both AUX pins together and bypass with a $0.1\mu F$ capacitor to ground. Load conditions may require additional bulk capacitance to maintain AUX voltage regulation.
4, 5	INA, INB	Power Input. Connect both IN pins together and bypass with a $0.1\mu F$ capacitor to GND. Load conditions may require additional bulk capacitance to maintain the IN voltage regulation.
7	\overline{ON}	Control Input. A logic low at \overline{ON} turns on the device. A logic high shuts off both outputs and all power to internal circuits. Driving \overline{ON} higher than IN does not cause damage.
9	\overline{FAULTB}	Fault Indicator Output for Channel B. This open-drain output goes low when channel B is in thermal shutdown or in undervoltage lockout or in a sustained ($>20ms$) current-limit or short-circuit condition.
10	ADJB	Current-Limit Adjust for Channel B. When operating from auxiliary input, adjust the current limit by connecting a resistor from ADJB to GND as shown in <i>Programmable Current Limit</i> .
11, 12	OUTB1, OUTB2	Power Output B. Connect both OUTB_ pins together. Connect a $1\mu F$ or greater capacitor from OUTB_ to ground. Load condition may require additional bulk capacitance.
13, 14	OUTA1, OUTA2	Power Output A. Connect both OUTA_ pins together. Connect a $1\mu F$ or greater capacitor from OUTA_ to ground. Load condition may require additional bulk capacitance.

Dual USB Switch with Fault Blanking and Autoreset

Pin Description (continued)

PIN	NAME	FUNCTION
15	ADJA	Current-Limit Adjust for Channel A. When operating from auxiliary input, adjust the current limit by connecting a resistor from ADJA to GND as shown in <i>Programmable Current Limit</i> .
16	$\overline{\text{FAULTA}}$	Fault Indicator Output for Channel A. This open-drain output goes low when channel A is in thermal shutdown or undervoltage lockout or in a sustained (>20ms) current-limit or short-circuit condition.

Detailed Description

The MAX1838 is a dual, current-limited switch with auxiliary inputs designed for USB applications. It has two independent channels, each with its own fault-blanking and autoreset function. Each channel has an error flag output to notify the USB controller when the current limit, short circuit, undervoltage lockout, or thermal shutdown threshold is reached. A single input enables both channels. The MAX1838 supplies the outputs from one of two inputs, IN or AUX, selected by SEL (Table 1).

The MAX1838 operates from 4V to 5.5V input voltage range and guarantees a 500mA (min) output current. A 0.9A built-in current limit limits the current in the event of a heavy overload condition. When powering the switches from the auxiliary input, each channel has an adjustable current limit. The MAX1838 has independent thermal shutdown for each channel in the event of a prolonged overload or short-circuit condition. The autoreset function monitors the overload and automatically turns the switch on when the overload is removed.

Use of internal, low- R_{ON} NMOS switches enables the MAX1838 to provide four switches in the small 16-pin QSOP package. Internal micropower charge pumps generate the gate drive of these high-side switches. Separate current limiting and thermal shutdown circuits permit each switch to operate independently, improving system robustness.

Input Voltage Requirements and Undervoltage Lockout

The MAX1838 operates in one of three modes (Table 1). The device receives its supply current from the AUX input. When $V_{AUX_}$ falls below the 3.8V undervoltage lockout voltage, the MAX1838 shuts down to prevent erroneous switch operation.

Table 1. MAX1838 Operation Modes

Power from IN (SEL high)	Both A and B outputs receive current from IN. The IC is powered from AUX.
Power from AUX (SEL low)	Both A and B outputs receive current from AUX. The IC is powered from AUX. $V_{IN_}$ may drop to zero in this mode.
Full Shutdown ($\overline{\text{ON}}$ high)	Both A and B outputs are open and no power is available. Either $V_{IN_}$ or $V_{AUX_}$ may drop to zero.

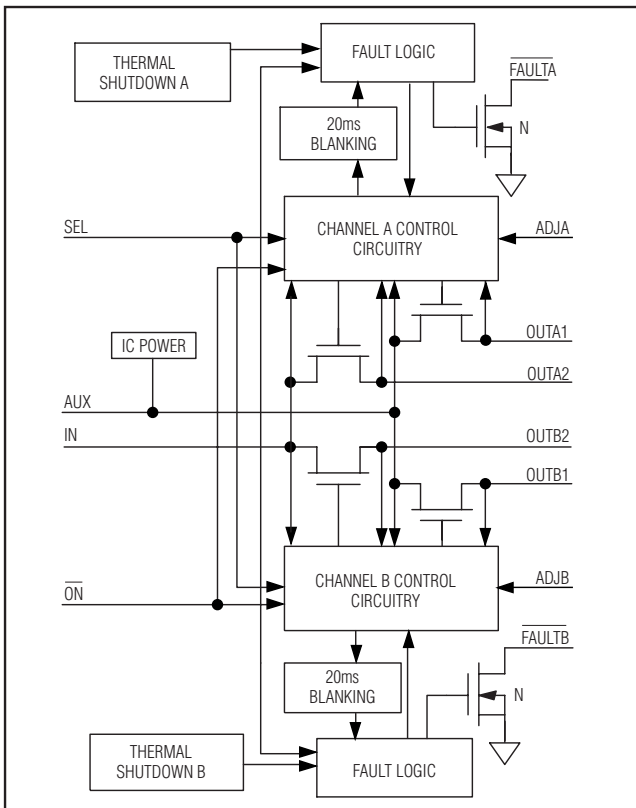

Figure 1. Simplified Functional Diagram

Dual USB Switch with Fault Blanking and Autoreset

Output Fault Protection

The MAX1838 senses the switch output voltage and selects 0.9A continuous current limiting when V_{OUT} is greater than 1V or short-circuit current limiting when V_{OUT} is less than 1V (see *Behavior During Current Limit and Fault Blanking*).

Autoreset Mode

The MAX1838 monitors the output to detect an overload condition. If an output fault is detected for more than the 20ms blanking time, OUT_+ latches, \overline{FAULT} goes low, and OUT sources 25mA to the load. If the voltage at OUT exceeds 0.5V for 20ms, the fault resets, the 25mA current source shuts down, and the channel turns back on. For proper autoreset function, the output load current must remain below 25mA when the output voltage is lower than 0.5V. Toggle \overline{ON} to manually reset the output.

Thermal Shutdown

The MAX1838 features independent thermal shutdown for each channel, allowing one channel to deliver power even if the other channel has a fault condition. When the junction temperature exceeds +160°C, the switch turns off and \overline{FAULT}_+ goes low immediately. Fault blanking does not occur during thermal limit. When the junction cools by 15°C, the channel turns on again. If the fault overload condition continues, the channel cycles on and off, resulting in a pulsed output.

Fault Indicators

The MAX1838 provides an open-drain fault output (\overline{FAULT}) for each channel. For most applications, connect \overline{FAULT} to AUX through a 100k Ω pullup resistor. \overline{FAULT} goes low when any one of the following conditions occurs:

- V_{AUX_+} is below the undervoltage-lockout (UVLO) threshold.
- V_{IN_+} is below the undervoltage-lockout threshold and $SEL = AUX$.
- The switch junction temperature exceeds the thermal shutdown temperature limit of +160°C.
- The switch is in current-limit or short-circuit limit mode after the fault-blanking period is exceeded (autoreset).

After the fault condition is removed, the \overline{FAULT} output deasserts after a 20ms delay. Ensure that the MAX1838 has adequate input bypass capacitance to prevent glitches from triggering \overline{FAULT} outputs. Input glitches greater than 0.2V/ μ s may cause erroneous \overline{FAULT} indications.

Programmable Current Limit

When using the auxiliary input (AUX), each channel has an adjustable current limit. For maximum current limit (0.9A), open ADJ. For current limits below 0.9A, connect a resistor from ADJ to GND according to the following equation:

$$I_{OUT_+} = 0.9A \times R_{ADJ} / (200k\Omega + R_{ADJ})$$

Behavior During Current Limit and Fault Blanking

The MAX1838 limits switch current in the following ways. When \overline{ON} is high, both channels are off. When \overline{ON} is low, both channels can supply a continuous output current of at least 500mA. When the output current exceeds the 0.9A threshold, the MAX1838 will limit the current depending on the output voltage. If V_{OUT} is greater than 1V (current-limit mode), the MAX1838 regulates the output current to 0.9A. If V_{OUT} is less than 1V (short-circuit mode), the MAX1838 pulses the output, decreasing the current to 0.35A_{RMS} (Table 2). Note that a thermal overload may result from either of these high-current conditions.

The MAX1838 switches may enter current limit in normal operation when powering up or driving heavy capacitive loads. To differentiate these conditions from short circuits or sustained overloads that may damage the device, the MAX1838 has an independent fault-blanking circuit in each channel. When a load transient causes the device to enter current limit, an internal counter starts to monitor the duration of the fault. If the load fault persists beyond the 20ms fault-blanking time, the channel turns off, \overline{FAULT} asserts low, and the channel enters autoreset mode (see *Autoreset Mode*). Only current-limit and short-circuit faults are blanked. Thermal overload faults and input undervoltage immediately cause the channel to turn off and \overline{FAULT} to assert low.

Fault blanking allows the MAX1838 to accommodate USB loads that may not be fully compliant with the USB specifications. USB loads with additional bypass capacitance and/or large startup currents can be successfully powered while protecting the upstream power source. If the switch is able to bring up the load within the 20ms blanking period, no fault is indicated.

Switching Supplies

To select IN as the source for both channels, drive SEL to a logic high. To select AUX, drive SEL low. To minimize switching transients, the MAX1838 switches between input supplies (IN and AUX) with a make-before-break sequence. Both switches are on simultaneously for up to 9ms before the initial supply is disconnected. When switching from IN to AUX, a significant current may flow

Dual USB Switch with Fault Blanking and Autoreset

between IN and AUX. However, a fault does not trigger since the fault blanking-time is longer than the supply switchover time.

Applications Information

Input Power Source

AUX provides the power for the MAX1838 internal control circuitry. Limit the input-voltage slew rate to less than $0.2\text{V}/\mu\text{s}$ to prevent erroneous FAULT indications.

Input Capacitor

To limit the input voltage drop during momentary output short-circuit conditions, connect a capacitor from both AUX and IN to ground. A $0.1\mu\text{F}$ ceramic capacitor is required for local decoupling; however, higher capacitor values will further reduce the voltage drop at the input (Figure 2). When driving inductive loads, a larger capacitance prevents voltage spikes from exceeding the MAX1838's absolute maximum ratings.

Output Capacitor

An output capacitor helps prevent parasitic inductance from pulling OUT negative during turn-off. When starting up into very large capacitive loads, the switch pulses the output current at $0.35\text{A}_{\text{RMS}}$ until the output voltage rises above 1V , then the capacitor continues to charge at the full 0.9A current limit. There is no limit to the size of output capacitor, but to prevent a startup fault assertion, the capacitor must charge up within the fault-blanking delay period. Typically starting up into a $330\mu\text{F}$ or smaller capacitor does not trigger a fault output. In addition to bulk capacitance, small value ($0.1\mu\text{F}$ or greater) ceramic capacitors improve the output's resilience to electrostatic discharge (ESD).

Driving Inductive Loads

A wide variety of devices (mice, keyboards, cameras, and printers) can load the USB port. These devices commonly connect to the port with cables, which can add an inductive component to the load. This inductance causes the output voltage at the USB port to ring

Table 2. MAX1838 Current Limiting and Fault Behavior

CONDITION	MAX1838 BEHAVIOR
If a short circuit is present ($V_{\text{OUT}} < 1\text{V}$)	<ul style="list-style-type: none"> If a short circuit is detected at the output, the channel turns off, the blanking timer begins, and FAULT stays high. If the short circuit persists during the fault-blanking period, the output pulses at $0.35\text{A}_{\text{RMS}}$. When the short is removed before the 15ms short-circuit blanking timeout period, the next ramped current pulse soft-starts the output. The FAULT flag stays high. If the short circuit persists after the fault-blanking period, FAULT goes low, autoreset mode is enabled, and the output sources 25mA. If the voltage on that output is above 0.5V for 20ms, the channel resets, the output turns on, and FAULT goes high (see Short-Circuit Response in the <i>Typical Operating Characteristics</i>.)
If an overload current is present ($V_{\text{OUT}} > 1\text{V}$)	<ul style="list-style-type: none"> Output current regulates at I_{LIM}, the blanking timer turns on, and FAULT stays high. Continuous current at I_{LIM} persists until the overload is removed, a thermal fault occurs, or the 20ms continuous current-limit timeout period is reached. If overcurrent is still present at 20ms, FAULT goes low, autoreset mode is enabled, and the output sources 25mA. If the voltage on that output is above 0.5V for 20ms, the channel resets, the output turns on, and FAULT goes high.
If thermal fault condition is present	<ul style="list-style-type: none"> FAULT immediately goes low (the blanking timer does not apply to thermal faults), and the channel turns off. When the junction cools by 15°C, the thermal fault condition is removed, autoreset mode is enabled, the output sources 25mA, and FAULT remains low. If the voltage on that output is above 0.5V for 20ms, the channel resets, the output turns on, and FAULT goes high.

Dual USB Switch with Fault Blanking and Autoreset

during a load step. The MAX1838 is capable of driving inductive loads, but avoid exceeding the device's absolute maximum ratings. Usually the load inductance is relatively small, and the MAX1838's input includes a substantial bulk capacitance from an upstream regulator as well as local bypass capacitors, limiting overshoot. If severe ringing occurs due to large load inductance, clamp the MAX1838's output below 6V and above -0.3V.

Turn-On and Turn-Off Behavior

In absence of faults, the MAX1838's internal switches turn on and off slowly under the control of the $\overline{\text{ON}}$ input. The slow charge-pump switch-drive minimizes load transients on the upstream power source. Under thermal fault and undervoltage lockout, the power device turns off rapidly to protect the switch and the power source.

Layout and Thermal Dissipation

To optimize the switch response to output short-circuit conditions, keep all traces as short as possible to reduce the effect of undesirable parasitic inductance. Place input and output capacitors no more than 5mm from device leads. IN, AUX, and OUT pins must be connected with short traces to the power bus. Wide power bus planes provide superior switch heat dissipation. While the switches are on, power dissipation is small and the package temperature rise is minimal. Calculate the power dissipation for this condition as follows:

$$P = (I_{\text{OUT}})^2 R_{\text{ON}}$$

For the normal operating current ($I_{\text{OUT}} = 0.5\text{A}$), the maximum on-resistance of the switch is $170\text{m}\Omega$, and the power dissipation is:

$$P = (0.5\text{A})^2 \times 0.170\Omega = 43\text{mW per switch}$$

The worst-case power dissipation occurs when the switch is in current limit and the output is greater than 1V. In this case, the power dissipated in each switch is the voltage drop across the switch multiplied by the current limit:

$$P = (I_{\text{LIM}}) (V_{\text{IN}} - V_{\text{OUT}})$$

For a 5V input and 1V output, the maximum power dissipation per switch is:

$$P = (1.2\text{A}) (5.5\text{V} - 1\text{V}) = 5.4\text{W}$$

Since the package power dissipation is only 667mW, the MAX1838 die temperature will exceed the thermal shutdown threshold and the switch output shuts down until the junction temperature cools by 10°C . The duty cycle and period are strong functions of the ambient temperature and the PC board layout.

A short circuit at the output causes the power dissipated across the switch and the junction temperature to increase. If the fault condition persists, the thermal-overload-protection circuitry activates, and the output shuts down until the junction temperature decreases by 10°C (see *Thermal Shutdown*).

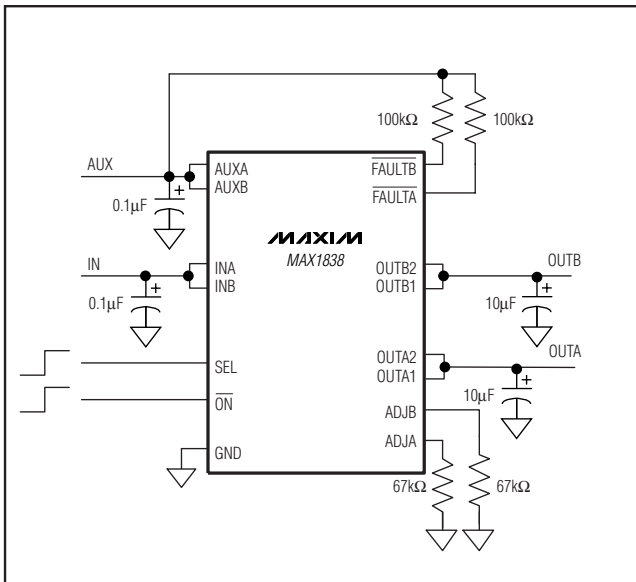

Figure 2. Typical Application Circuit

Dual USB Switch with Fault Blanking and Autoreset

Chip Information

PROCESS: BiCMOS

Package Information

For the latest package outline information and land patterns, go to www.maxim-ic.com/packages. Note that a "+", "#", or "-" in the package code indicates RoHS status only. Package drawings may show a different suffix character, but the drawing pertains to the package regardless of RoHS status.

PACKAGE TYPE	PACKAGE CODE	DOCUMENT NO.
16 QSOP	E16-5	21-0055

Dual USB Switch with Fault Blanking and Autoreset

Revision History

REVISION NUMBER	REVISION DATE	DESCRIPTION	PAGES CHANGED
0	4/01	Initial release	—
1	2/10	Removed UL Certification Pending bullet from <i>Features</i> section	1

MAX1838

Maxim cannot assume responsibility for use of any circuitry other than circuitry entirely embodied in a Maxim product. No circuit patent licenses are implied. Maxim reserves the right to change the circuitry and specifications without notice at any time.

Maxim Integrated Products, 120 San Gabriel Drive, Sunnyvale, CA 94086 408-737-7600 _____ 13

Looking for pricing, stock, or lifecycle information?

Click below to explore more details on WIN SOURCE:

 [View MAX1838EEE+T on WIN SOURCE](#)

 [Maxim Integrated](#) Information

Optimize Your Supply Chain with WIN SOURCE Solutions

-  Global Sourcing Solution
-  Obsolete Management
-  Cost Control Management
-  Shortage Management
-  Alternative Solution
-  Excess Inventory Management