



Low Input/Output Voltage Step-Up DC-DC Converter with **RESET**

MAX1947

General Description

The MAX1947 is a compact, high-efficiency, step-up DC-DC converter that regulates output voltages from 1.8V to 3.3V to power μ P/DSP cores, memory, and I/O rails in 1- and 2-cell alkaline/NiMH/NiCd battery-powered systems. It features an internal 800mA switch and synchronous rectifier to achieve up to 94% efficiency and to eliminate the need for an external Schottky diode.

High-frequency switching (up to 2MHz) results in low ripple and small external components, while automatic pulse skipping at light loads reduces supply current to just 70 μ A for extended battery life. Maxim's proprietary True Shutdown™ reduces supply current to just 2 μ A and fully discharges the output to ground. The converter is offered in fixed-output voltages of 1.8V, 2.5V, 3.0V, and 3.3V, requiring no feedback or compensation network. A 75ms RESET output flag provides for power-on reset (POR) and undervoltage detection. The MAX1947 is available in a space-saving 8-pin TDFN package.

Applications

MP3 Players, Pagers, and CD Players
PDAs and Organizers
Digital Still Cameras
Cordless Phones
Wireless Mice/Keyboards
Portable Medical Equipment
Other Battery-Powered Systems

Typical Application Circuit

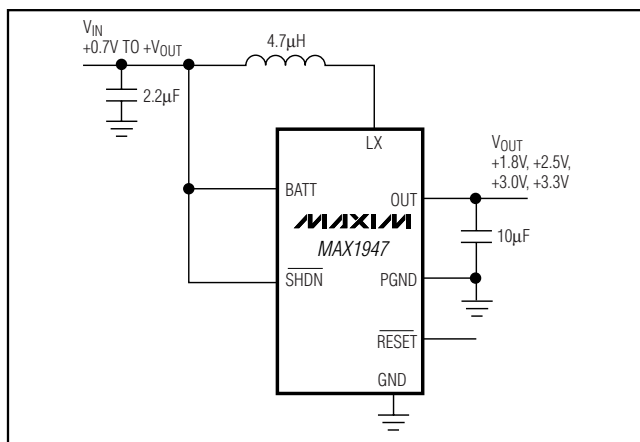

True Shutdown is a trademark of Maxim Integrated Products, Inc.

Features

- ◆ Low Input (0.7V) and Output (1.8V) Voltage Capability
- ◆ Internal Synchronous Rectifier
- ◆ High 94% Efficiency
- ◆ Fixed Output Voltages: 1.8V, 2.5V, 3V, and 3.3V
- ◆ Up to 2MHz Switching Allows Small External Components and Low Output Ripple
- ◆ Automatic Pulse Skipping at Light Loads for Extended Battery Life
- ◆ Low 70 μ A (typ) Operating Supply Current (Measured at OUT)
- ◆ Low 2 μ A Logic-Controlled Shutdown
- ◆ True Shutdown Fully Discharges Output to Ground
- ◆ Uses Only Small Ceramic Capacitors
- ◆ 75ms RESET Output Flag

Ordering Information

PART	TEMP RANGE	PIN-PACKAGE	PKG CODE
MAX1947ETAx ^y *-T	-40°C to +85°C	8 TDFN 3mm x 3mm	T833-1
MAX1947ETAx ^y *+T	-40°C to +85°C	8 TDFN 3mm x 3mm	T833-1

*xy represents the output voltage code (e.g., 18 = 1.8V). Standard output voltages include 3.3V (33), 3.0V (30), 2.5V (25), and 1.8V (18). Contact the factory for other output voltages in 100mV increments between 1.8V and 3.3V; the minimum order quantity is 25,000 units.
+Denotes lead-free package.

Pin Configuration

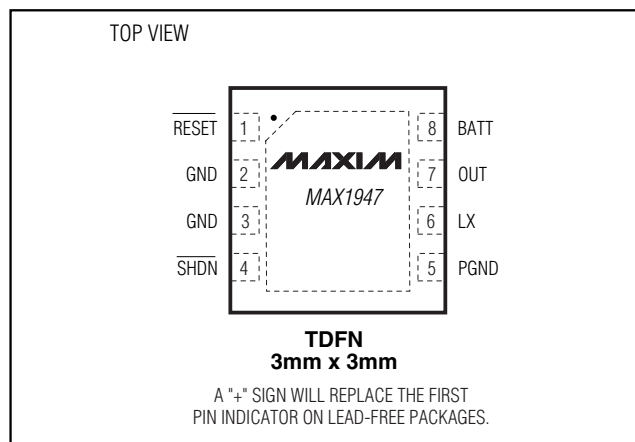

Low Input/Output Voltage Step-Up DC-DC Converter with **RESET**

ABSOLUTE MAXIMUM RATINGS

BATT, OUT, SHDN to GND	-0.3V to +4.0V
RESET to GND	-0.3V to (V _{OUT} + 0.3V)
PGND to GND	-0.3V to +0.3V
Switch Current (I _{LX} , I _{OUT} , I _{PGND}) (Note 1)	-1A to +1A
Continuous Power Dissipation (T _A = +70°C)	
8-Pin TDFN (derate 24.4mW/°C	
above +70°C)	1951.2mW

Operating Temperature Range	-40°C to +85°C
Junction Temperature	+150°C
Storage Temperature Range	-65°C to +150°C
Lead Temperature (soldering, 10s)	+300°C

Note 1: LX has internal clamp diodes to PGND and OUT. Applications that forward bias these diodes should take care not to exceed the IC's package power-dissipation limits.

Stresses beyond those listed under "Absolute Maximum Ratings" may cause permanent damage to the device. These are stress ratings only, and functional operation of the device at these or any other conditions beyond those indicated in the operational sections of the specifications is not implied. Exposure to absolute maximum rating conditions for extended periods may affect device reliability.

ELECTRICAL CHARACTERISTICS

(V_{BATT} = 1.5V, T_A = -40°C to +85°C, unless otherwise noted. Typical values are at T_A = +25°C.) (Note 2)

PARAMETER	CONDITIONS	MIN	TYP	MAX	UNITS
Minimum Startup Voltage	R _{LOAD} = 1kΩ, T _A = +25°C		0.8	0.95	V
Startup-Voltage Temperature Coefficient			-2.1		mV/°C
Maximum Input Operating Voltage	(Note 3)			3.6	V
Minimum Input Operating Voltage			0.7		V
Output Voltage	MAX1947ETA18, I _{LOAD} = 40mA	1.74	1.8	1.86	V
	MAX1947ETA25, I _{LOAD} = 32mA	2.42	2.5	2.58	
	MAX1947ETA30, I _{LOAD} = 25mA	2.9	3.0	3.1	
	MAX1947ETA33, I _{LOAD} = 25mA	3.2	3.3	3.4	
Load Regulation	No load to full load		1.2		%
Full-Load Output Current	V _{BATT} = 1V	MAX1947ETA18	160	273	mA
		MAX1947ETA25	130	214	
		MAX1947ETA30	100	185	
		MAX1947ETA33	100	169	
	V _{BATT} = 1.8V	MAX1947ETA25	240	380	
		MAX1947ETA30	200	361	
MAX1947ETA33	200	329			
Supply Current into BATT	No switching		2	4	μA
Supply Current into OUT	No switching		70	110	μA
LX Switch Maximum On-Time		0.7	1	1.3	μs
LX Switch Minimum Off-Time		0.2	0.25	0.3	μs
Maximum On-Time to Minimum Off-Time Ratio	V _{OUT} = 2.5V, 3.0V, 3.3V	3.6	4	4.6	s/s
	V _{OUT} = 1.8V	3.0	4	4.6	
Frequency in Startup			650		kHz

Low Input/Output Voltage Step-Up DC-DC Converter with **RESET**

MAX1947

ELECTRICAL CHARACTERISTICS (continued)

(V_{BATT} = 1.5V, T_A = -40°C to +85°C, unless otherwise noted. Typical values are at T_A = +25°C.) (Note 2)

PARAMETER	CONDITIONS		MIN	TYP	MAX	UNITS
Startup to Normal-Mode Output Transition Voltage	50mV hysteresis, rising edge		1.40	1.62	1.73	V
NFET Current Limit	T _A = 0°C to +85°C		600	800	1000	mA
	T _A = -40°C to +85°C		580	800	1000	
PFET Turn-Off Current	T _A = 0°C to +85°C		15	75	150	mA
	T _A = -40°C to +85°C		10	75	150	
Internal NFET On-Resistance	I _{LX} = 100mA	MAX1947ETA18		0.3	0.6	Ω
		MAX1947ETA25		0.22	0.44	
		MAX1947ETA30		0.17	0.34	
		MAX1947ETA33		0.15	0.3	
Internal PFET On-Resistance	I _{LX} = 100mA	MAX1947ETA18		0.5	1.0	Ω
		MAX1947ETA25		0.35	0.7	
		MAX1947ETA30		0.28	0.56	
		MAX1947ETA33		0.25	0.5	
LX Leakage Current	SHDN = GND, V _{OUT} = 0V, V _{LX} = 3.6V	T _A = +25°C		0.1	1	μA
		T _A = +85°C		1		
SHUTDOWN MODE						
Shutdown Supply Current	SHDN = GND			2	4	μA
SHDN Input Voltage	V _{IH}		0.8 x V _{BATT}			V
	V _{IL}				0.18 x V _{BATT}	
SHDN Input Bias Current	SHDN = OUT or GND, T _A = +25°C			1	100	nA
	SHDN = OUT or GND, T _A = +85°C			5		
OUT Discharge Resistance in Shutdown	SHDN = GND			500	1000	Ω
RESET OUTPUT						
Reset OUT Voltage Trip Level	V _{OUT} falling, 1% hysteresis		87	90	93	%
Minimum V _{OUT} for Valid Reset			0.9			V
Reset Timeout			65	140	235	ms
RESET Output Voltage	I _{SINK} = 200μA				0.3	V
	I _{SOURCE} = 200μA		0.8 x V _{OUT}			

Note 2: Limits are 100% production tested at T_A = +25°C. Limits over the operating temperature range are guaranteed by design.

Note 3: When BATT is greater than the output-voltage set point, the part is in track mode (see the *Track Mode* section).

Low Input/Output Voltage Step-Up DC-DC Converter with RESET

Typical Operating Characteristics

($V_{IN} = 1.5V$, Circuit of Typical Application Circuit, $T_A = +25^\circ C$, unless otherwise noted.)

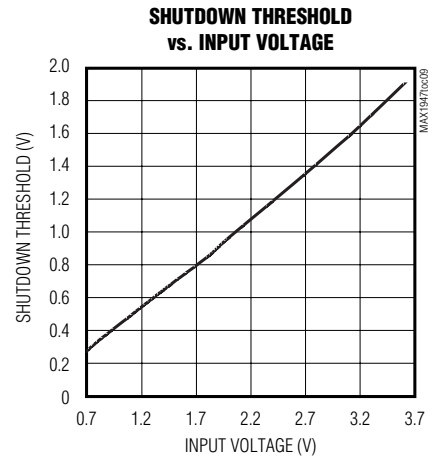
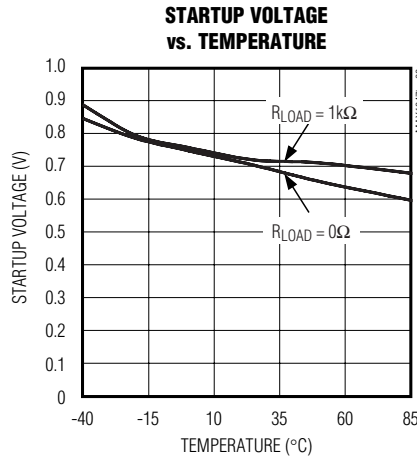
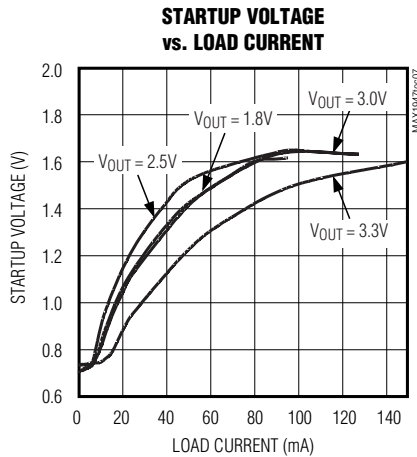
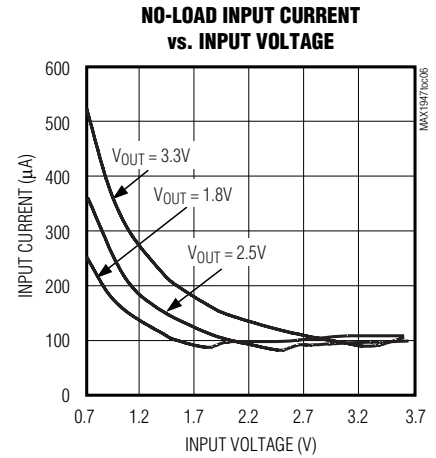
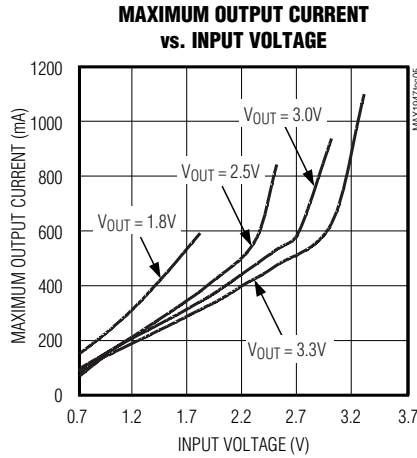
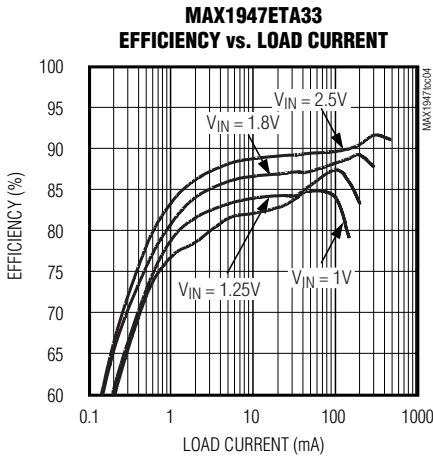
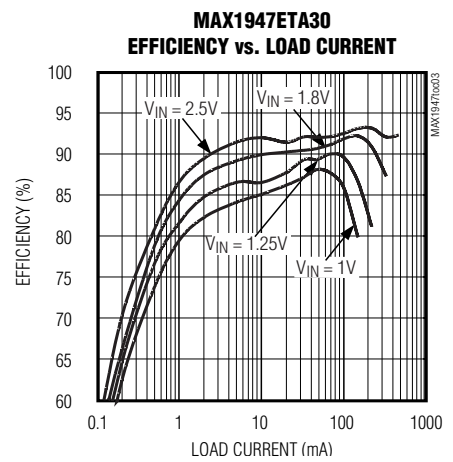
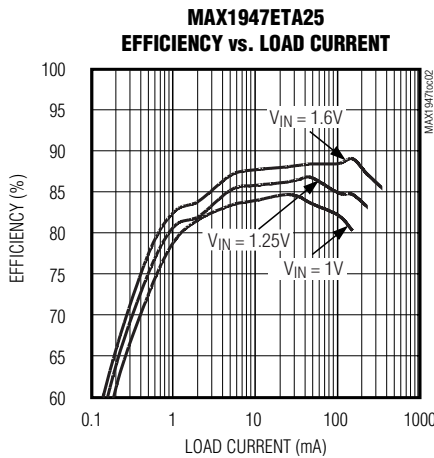
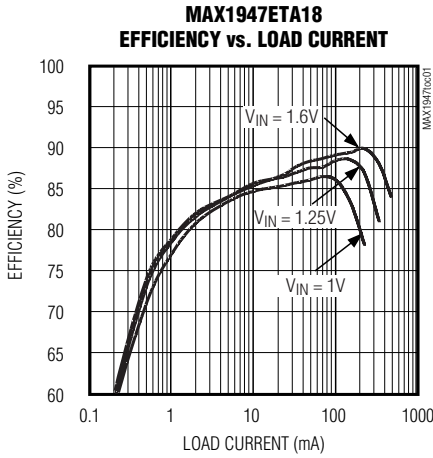

Low Input/Output Voltage Step-Up DC-DC Converter with RESET

MAX1947

Typical Operating Characteristics (continued)

($V_{IN} = 1.5V$, Circuit of Typical Application Circuit, $T_A = +25^\circ C$, unless otherwise noted.)

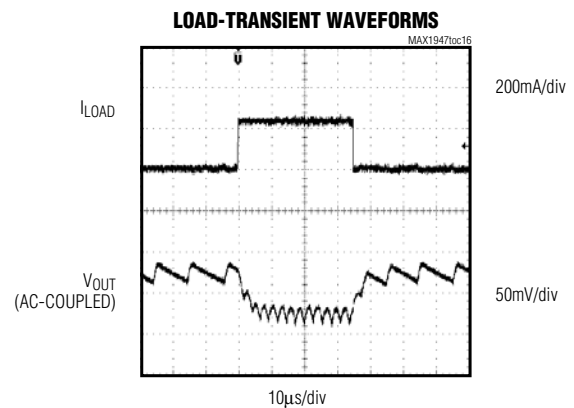
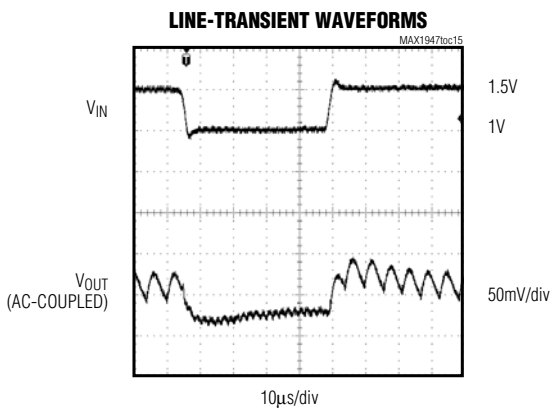
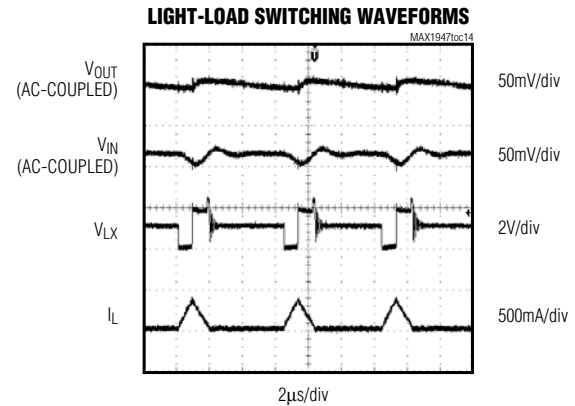
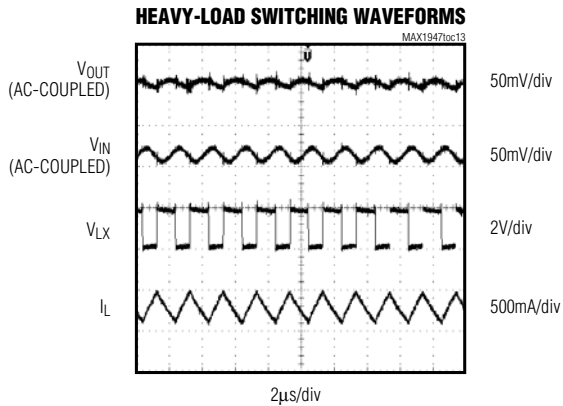
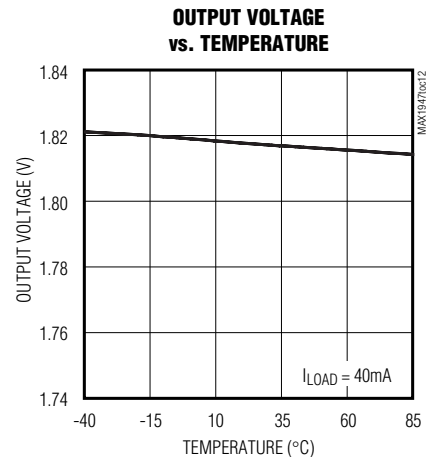
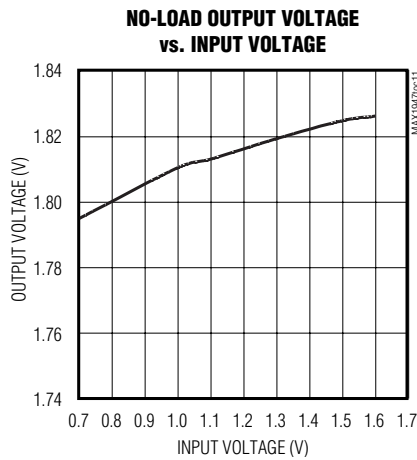
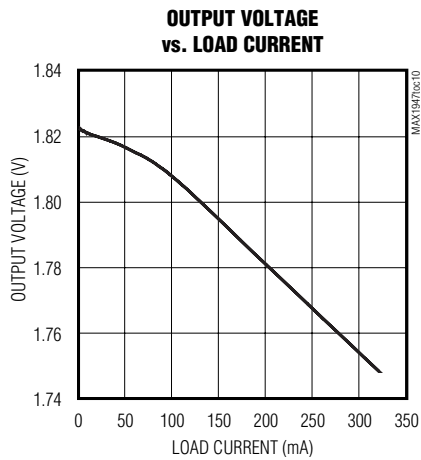

Low Input/Output Voltage Step-Up DC-DC Converter with **RESET**

Typical Operating Characteristics (continued)

($V_{IN} = 1.5V$, Circuit of Typical Application Circuit, $T_A = +25^\circ C$, unless otherwise noted.)

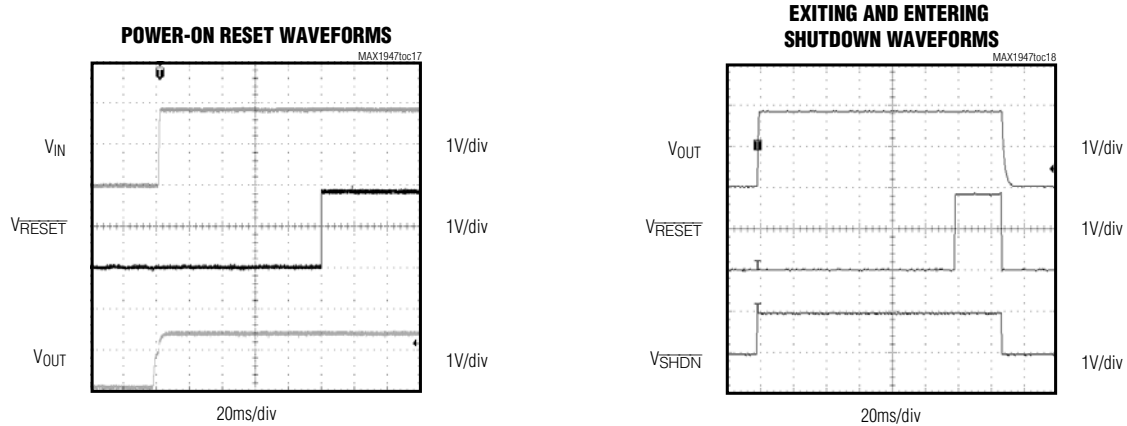

Pin Description

PIN	NAME	FUNCTION
1	\overline{RESET}	Active-Low Push-Pull Reset Output. \overline{RESET} goes high 75ms (min) after the output voltage has exceeded 90% of its final value. The \overline{RESET} output is valid for output voltages as low as 0.9V. \overline{RESET} is driven low in shutdown.
2	GND	Ground. Connect to exposed paddle.
3	GND	Ground. Connect to exposed paddle.
4	\overline{SHDN}	Shutdown Input. Connect to BATT or logic 1 for normal operation. Connect to GND or logic 0 for a low quiescent-current shutdown mode.
5	PGND	Power Ground. Connect to exposed paddle.
6	LX	Inductor Connection to the Drains of the Internal n-Channel Switch and p-Channel Synchronous Rectifier
7	OUT	Regulator Output. Bypass with 10 μ F ceramic capacitor to GND for full-load capability. For less than 50% of full load, a 4.7 μ F capacitor can be used.
8	BATT	Battery Connection. V_{BATT} is used for the startup oscillator and to power the chip when $V_{OUT} < V_{BATT}$.
—	EP	Exposed Paddle. Connect to GND and PGND.

Detailed Description

The MAX1947 compact step-up DC-DC converter starts up with voltages as low as 0.8V and operates with input voltages down to 0.7V. An internal synchronous rectifier reduces cost by eliminating the need for an external Schottky diode and improves overall efficiency by reducing losses in the circuit. The efficiency is further

increased with the low 70 μ A quiescent current and low on-resistance of the internal n-channel MOSFET power switch. The MAX1947 uses Maxim's proprietary True Shutdown circuitry, which disconnects the output from the input in shutdown and actively discharges the output to ground.

Low Input/Output Voltage Step-Up DC-DC Converter with **RESET**

Table 1. Suggested Component Values

APPLICATION	LOAD	INPUT CAPACITOR (μF)	OUTPUT CAPACITOR (μF)	INDUCTOR (μH)
1-Cell Input, Output < 2.7V	$\leq 50\%$ full load	2.2	4.7	3.3
	$> 50\%$ full load	2.2	10	3.3
1-Cell Input, Output > 2.7V	$\leq 50\%$ full load	2.2	4.7	4.7
	$> 50\%$ full load	2.2	10	4.7
2-Cell Input	$\leq 50\%$ full load	2.2	4.7	6.8
	$> 50\%$ full load	2.2	10	6.8

Table 2. Suggested Component Manufacturers

MANUFACTURER	PART	PART NUMBER	PHONE	WEBSITE
Sumida	Inductor	CDRH3D16 series	81-3-3667-3381	www.sumida.com
Taiyo Yuden	Output capacitors	4.7 μF JMK212BJ475MG, 10 μF JMK212BJ106MG	408-573-4150	www.t-yuden.com
	Input capacitors	2.2 μF LMK107BJ225MA		
TDK	Output capacitors	4.7 μF C2012X5R0J475K, 10 μF C2012X5R0J106K	888-835-6646	www.TDK.com
	Input capacitors	2.2 μF C1608X5R03225M		

Shutdown

The MAX1947 enters shutdown mode when $\overline{\text{SHDN}}$ is driven low. During shutdown, the synchronous rectifier disconnects the output from the input, eliminating the DC conduction path that normally exists with traditional boost converters in shutdown mode. The output is actively discharged to ground through an internal 500 Ω resistor. The quiescent current is reduced to 2 μA while in shutdown mode. Drive $\overline{\text{SHDN}}$ high for normal operation. The output reaches regulation approximately 650 μs after $\overline{\text{SHDN}}$ goes high.

Applications Information

Inductor Selection

An inductor value of 4.7 μH performs well in most applications. The MAX1947 also works with inductors in the 2.2 μH to 6.8 μH range. Smaller inductance values typi-

cally offer a smaller physical size for a given series resistance, allowing the smallest overall circuit dimensions but with lower output-current capability. Circuits using larger inductance values exhibit higher output-current capability, but are larger for the same series resistance and current rating.

The inductor's incremental saturation current rating should be greater than the peak switch-current limit. However, it is generally acceptable to bias the inductor into saturation by as much as 20%, although this slightly reduces efficiency (see the *Electrical Characteristics* for the MAX1947 NFET current limit). Table 1 lists the suggested components for several typical applications. Also, the inductor's DC resistance significantly affects efficiency. Table 2 lists suggested component manufacturers.

Low Input/Output Voltage Step-Up DC-DC Converter with RESET

Calculate the maximum output current (I_{OUTMAX}) using inductor ripple current (I_{RIPPLE}) and duty cycle (D) as follows:

$$I_{RIPPLE} = \frac{V_{OUT} + I_{LIM} \times (R_{DS(ON)PFET} + R_L) - V_{BATT}}{L/t_{OFF} + \frac{(R_{DS(ON)PFET} + R_L)}{2}}$$

$$D = \frac{\left[\frac{V_{OUT} + (I_{LIM} - \frac{I_{RIPPLE}}{2}) \times (R_{DS(ON)PFET} + R_L)}{(R_{DS(ON)PFET} + R_L) - V_{BATT}} \right]}{\left[\frac{V_{OUT} + (I_{LIM} - \frac{I_{RIPPLE}}{2}) \times (R_{DS(ON)PFET} - R_{DS(ON)NFET} + R_L)}{(R_{DS(ON)PFET} - R_{DS(ON)NFET} + R_L)} \right]}$$

$$I_{OUTMAX} = (I_{LIM} - \frac{I_{RIPPLE}}{2}) \times (1 - D)$$

Here, I_{LIM} is the NFET current limit (800mA typ), t_{OFF} is the LX switch's off-time (0.25 μ s typ), and R_L is the series resistance of the inductor.

Capacitor Selection

The MAX1947 is specifically designed for using small, inexpensive, low-ESR ceramic capacitors. X5R and X7R dielectrics are recommended when operating over wide temperature ranges. Bypass the output of the MAX1947 with 10 μ F when using maximum load currents. When using less than half the maximum load current capability, the output capacitor can be reduced to 4.7 μ F. Bypass the input with a 2.2 μ F or larger ceramic capacitor. Table 1 lists the suggested values for the input and output capacitors for typical applications.

PCB Layout and Grounding

Careful PCB layout is important for minimizing ground bounce and noise. Keep the IC's GND pins and the ground leads of the input and output filter capacitors very close together. Connect GND and PGND directly to the exposed paddle. In addition, keep all connections to the OUT and LX pins as short as possible. To maximize output power and efficiency and minimize output ripple voltage, use short, wide traces from the input and output. A sample layout is available in the MAX1947 evaluation kit.

Chip Information

TRANSISTOR COUNT: 5156

PROCESS: BiCMOS

Low Input/Output Voltage Step-Up DC-DC Converter with **RESET**

Package Information

(The package drawing(s) in this data sheet may not reflect the most current specifications. For the latest package outline information, go to www.maxim-ic.com/packages.)

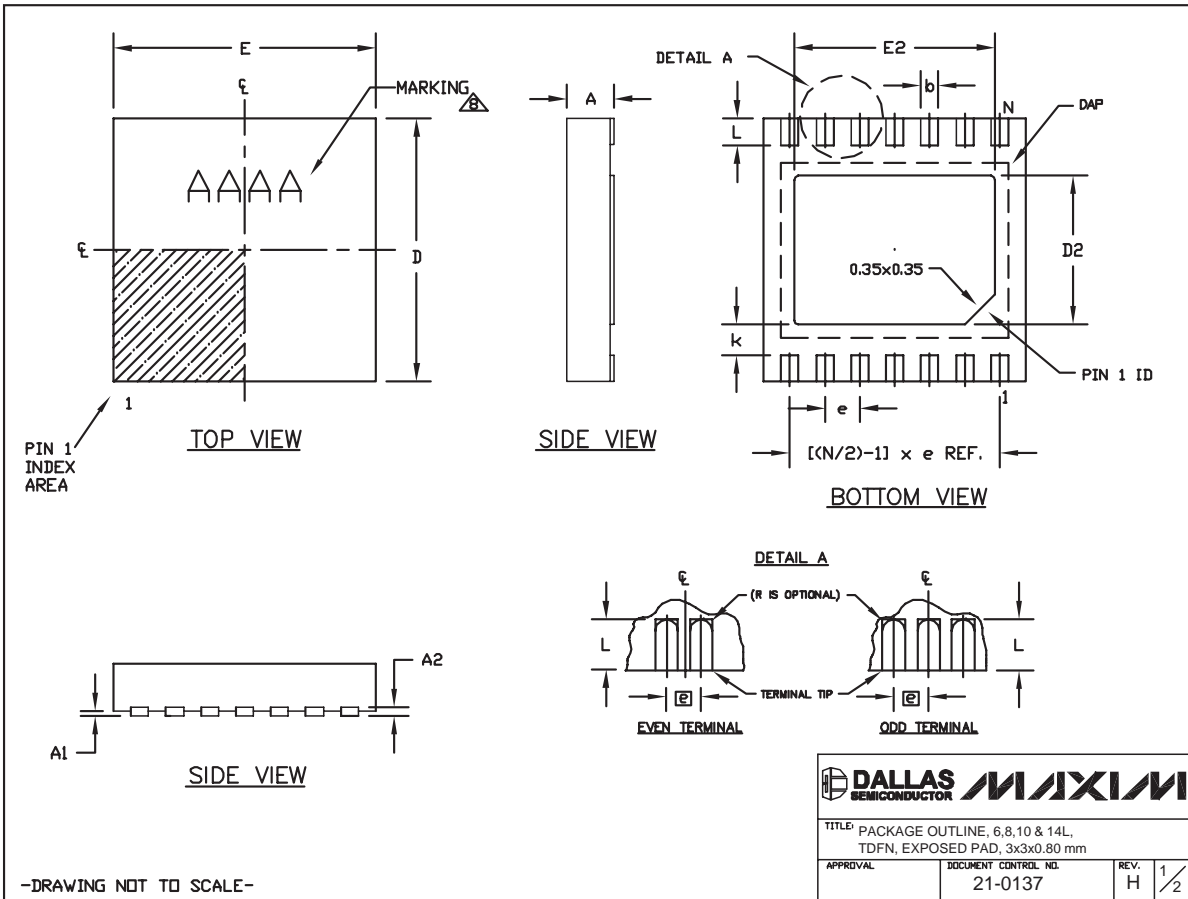

6, 8, & 10L, DFN THINLEPS

Low Input/Output Voltage Step-Up DC-DC Converter with **RESET**

MAX1947

Package Information

(The package drawing(s) in this data sheet may not reflect the most current specifications. For the latest package outline information, go to www.maxim-ic.com/packages.)

COMMON DIMENSIONS		
SYMBOL	MIN.	MAX.
A	0.70	0.80
D	2.90	3.10
E	2.90	3.10
A1	0.00	0.05
L	0.20	0.40
k	0.25 MIN.	
A2	0.20 REF.	

PACKAGE VARIATIONS								
PKG. CODE	N	D2	E2	e	JEDEC SPEC	b	[(N/2)-1] x e	
T633-1	6	1.50±0.10	2.30±0.10	0.95 BSC	MO229 / WEEA	0.40±0.05	1.90 REF	
T633-2	6	1.50±0.10	2.30±0.10	0.95 BSC	MO229 / WEEA	0.40±0.05	1.90 REF	
T833-1	8	1.50±0.10	2.30±0.10	0.65 BSC	MO229 / WEEC	0.30±0.05	1.95 REF	
T833-2	8	1.50±0.10	2.30±0.10	0.65 BSC	MO229 / WEEC	0.30±0.05	1.95 REF	
T833-3	8	1.50±0.10	2.30±0.10	0.65 BSC	MO229 / WEEC	0.30±0.05	1.95 REF	
T1033-1	10	1.50±0.10	2.30±0.10	0.50 BSC	MO229 / WEED-3	0.25±0.05	2.00 REF	
T1033-2	10	1.50±0.10	2.30±0.10	0.50 BSC	MO229 / WEED-3	0.25±0.05	2.00 REF	
T1433-1	14	1.70±0.10	2.30±0.10	0.40 BSC	----	0.20±0.05	2.40 REF	
T1433-2	14	1.70±0.10	2.30±0.10	0.40 BSC	----	0.20±0.05	2.40 REF	

NOTES:

1. ALL DIMENSIONS ARE IN mm. ANGLES IN DEGREES.
2. COPLANARITY SHALL NOT EXCEED 0.08 mm.
3. WARPAGE SHALL NOT EXCEED 0.10 mm.
4. PACKAGE LENGTH/PACKAGE WIDTH ARE CONSIDERED AS SPECIAL CHARACTERISTIC(S).
5. DRAWING CONFORMS TO JEDEC MO229, EXCEPT DIMENSIONS "D2" AND "E2", AND T1433-1 & T1433-2.
6. "N" IS THE TOTAL NUMBER OF LEADS.
7. NUMBER OF LEADS SHOWN ARE FOR REFERENCE ONLY.
8. MARKING IS FOR PACKAGE ORIENTATION REFERENCE ONLY.

	
TITLE: PACKAGE OUTLINE, 6,8,10 & 14L, TDFN, EXPOSED PAD, 3x3x0.80 mm	
APPROVAL	DOCUMENT CONTROL NO. 21-0137
REV. H	REV. 2/2

-DRAWING NOT TO SCALE-

Revision History



Pages changed at Revision 5: 1, 2, 8, 10

Maxim cannot assume responsibility for use of any circuitry other than circuitry entirely embodied in a Maxim product. No circuit patent licenses are implied. Maxim reserves the right to change the circuitry and specifications without notice at any time.

11 **Maxim Integrated Products, 120 San Gabriel Drive, Sunnyvale, CA 94086 408-737-7600**

Looking for pricing, stock, or lifecycle information?

Click below to explore more details on WIN SOURCE:

-  [View MAX1947ETA25+T on WIN SOURCE](#)
-  [Maxim Integrated Information](#)

Optimize Your Supply Chain with WIN SOURCE Solutions

-  Global Sourcing Solution
-  Obsolete Management
-  Cost Control Management
-  Shortage Management
-  Alternative Solution
-  Excess Inventory Management