



**THE DATASHEET OF  
MAX3787ABL+T**



# 1Gbps to 12.5Gbps Passive Equalizer for Backplanes and Cables

## General Description

The MAX3787 is a 1Gbps to 12.5Gbps equalization network that compensates for transmission medium losses encountered with FR4 and cables. The equalization network is composed entirely of passive components and functions equally well for 8b/10b or scrambled signals. It is packaged in a small 1.5mm x 1.5mm chip-scale package (UCSP™) that can be placed anywhere along the transmission medium to increase jitter margin for high-speed interconnects. Roughly the size of two 0603 components, the MAX3787 easily provides placement and routing flexibility.

At 8.5Gbps, the MAX3787 compensates for spans up to 18in of FR4 and 7m of cable. At 12.5Gbps, the MAX3787 compensates for spans up to 12in of FR4 and 3m of cable. Input and output impedance is 100Ω differential. The MAX3787 requires no power and operates over a -40°C to +125°C temperature range.

## Applications

- Backplane Interconnect Compensation
- Cable Interconnect Compensation
- Chip-to-Chip Link Extensions
- Ethernet and Fibre-Channel Serial Modules
- Chassis Life Extension

UCSP is a trademark of Maxim Integrated Products, Inc.

## Features

- ◆ No Power Supply Required
- ◆ Small 1.5mm x 1.5mm Chip-Scale Package
- ◆ Passive Equalization Reduces ISI
- ◆ Operates from 1Gbps to 12.5Gbps
- ◆ Extends Board Link
- ◆ Extends Cable Link
- ◆ Coding Independent, 8b/10b or Scrambled

## Ordering Information

| PART        | TEMP RANGE      | PIN-PACKAGE | PKG CODE |
|-------------|-----------------|-------------|----------|
| MAX3787ABL  | -40°C to +125°C | 4 UCSP      | B9-7     |
| MAX3787AWL+ | -40°C to +125°C | 4 WLP       | W91B1+3  |

+Denotes a lead-free package.

## Pin Configuration

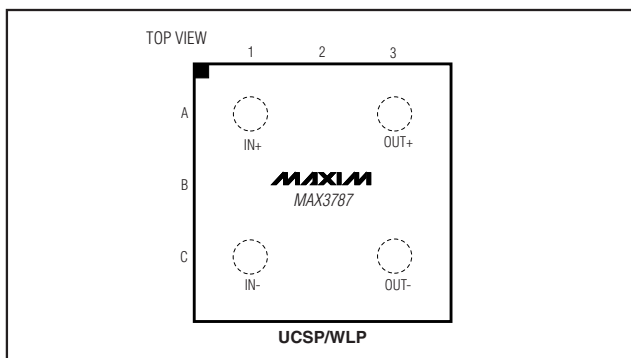

## Typical Application Circuits

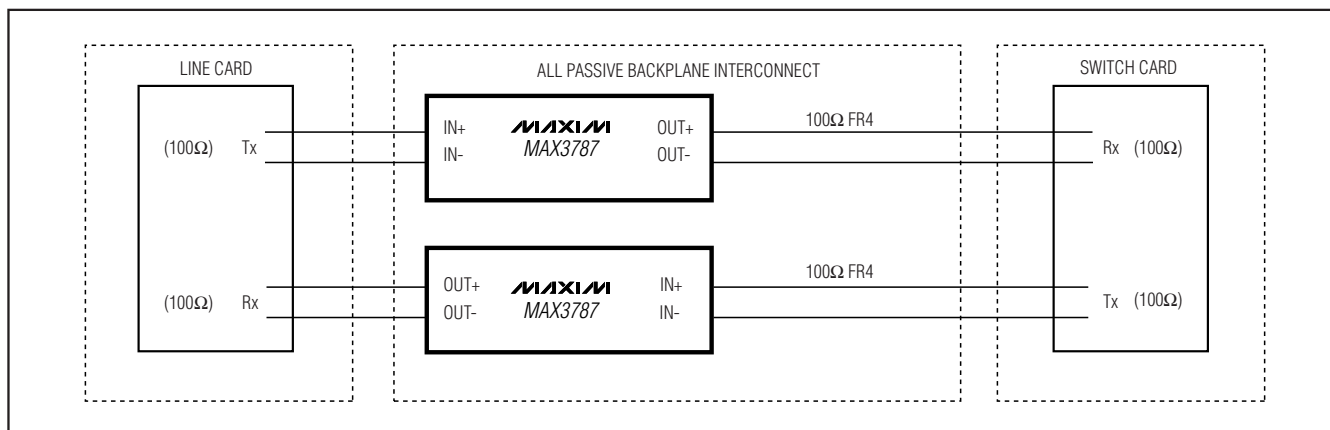

Typical Application Circuits continued at end of data sheet.

# 1Gbps to 12.5Gbps Passive Equalizer for Backplanes and Cables

## ABSOLUTE MAXIMUM RATINGS

Voltage between (IN+ and OUT+) or (IN- and OUT-) .....+2V  
 Voltage between (IN+ and IN-) or (OUT+ and OUT-) .....+4V  
 Voltage between (IN+ and OUT-) or (IN- and OUT+) .....+4V

Continuous Power Dissipation ( $T_A = +70^\circ\text{C}$ )  
 4-Bump UCSP (derate 3.0mW/ $^\circ\text{C}$  above  $+70^\circ\text{C}$ ) .....238mW  
 Operating Junction Temperature ..... $+150^\circ\text{C}$   
 Storage Ambient Temperature Range ..... $-55^\circ\text{C}$  to  $+150^\circ\text{C}$

*Stresses beyond those listed under "Absolute Maximum Ratings" may cause permanent damage to the device. These are stress ratings only, and functional operation of the device at these or any other conditions beyond those indicated in the operational sections of the specifications is not implied. Exposure to absolute maximum rating conditions for extended periods may affect device reliability.*

## OPERATING CONDITIONS

| PARAMETER                     | SYMBOL | CONDITIONS                   | MIN | TYP | MAX  | UNITS            |
|-------------------------------|--------|------------------------------|-----|-----|------|------------------|
| Operating Ambient Temperature | $T_A$  |                              | -40 | +25 | +125 | $^\circ\text{C}$ |
| Bit Rate                      |        | NRZ data                     | 1   |     | 12.5 | Gbps             |
| CID Tolerance                 |        | Consecutive identical digits |     |     | 100  | Bits             |

## ELECTRICAL CHARACTERISTICS

(Specifications guaranteed over specified operating conditions. Typical values measured at  $T_A = +25^\circ\text{C}$ .)

| PARAMETER   | SYMBOL | CONDITIONS   | MIN                     | TYP  | MAX  | UNITS             |
|---|--------|--|-------------------------|------|------|-------------------|
| Supply Current                                      |        |  |                         | 0.0  |      | mA                |
| Input Swing   |        | Measured differentially at point A in Figure 1               |                         |      | 3600 | mV <sub>p-p</sub> |
| Compensation  |        | 5GHz relative to 100MHz                                      |                         | 6    |      | dB                |
| Input Impedance                                     |        | Differential, $Z_{\text{LOAD}} = 100\Omega$                  |                         | 100  |      | $\Omega$          |
| Output Impedance                                    |        | Differential, $Z_{\text{SOURCE}} = 100\Omega$                |                         | 100  |      | $\Omega$          |
| Through Response                                    |        | Relative to ideal load, see Figure 2 for setup               | See Figure 3 for limits |      |      |                   |
| Input Return Loss                                   |        | 100MHz to 6GHz   |                         | 15   |      | dB                |
| Output Return Loss                                  |        | 100MHz to 6GHz   |                         | 15   |      | dB                |
| Resistance IN+ to IN- and OUT+ to OUT-              |        | No load, high impedance on all ports                         | 112                     |      | 152  | $\Omega$          |
| Resistance IN+ to OUT+ and IN- to OUT-              |        | No load, high impedance on all ports                         | 32                      |      | 44   | $\Omega$          |
| Resistance IN+ to OUT- and IN- to OUT+              |        | No load, high impedance on all ports                         | 112                     |      | 152  | $\Omega$          |
| DC Gain (OUT/IN)                                    |        | $Z_{\text{LOAD}} = 100\Omega$                                |                         | 0.5  |      |                   |
| Residual Deterministic Jitter (Table 1, Notes 1, 2) |        | 3.125Gbps and 6.25Gbps, 18in of 6mil microstrip FR4          |                         | 0.05 |      | UI                |
|   |        | 8.5Gbps, 10.0Gbps, and 12.5Gbps, 18in of 6mil microstrip FR4 |                         | 0.10 |      |                   |

**Note 1:** Signal applied differentially at point A as shown in Figure 1. The deterministic jitter at point B is from media-induced loss, not from clock-source modulation. Deterministic jitter is measured at the 50% vertical level of the signal at point C.

**Note 2:** Difference in deterministic jitter between reference points A and C in Figure 1. Stress pattern:  $2^7$  PRBS, 100 zeros, 1, 0, 1, 0, 27 PRBS, 100 ones, 0, 1, 0, 1.

# 1Gbps to 12.5Gbps Passive Equalizer for Backplanes and Cables

MAX3787

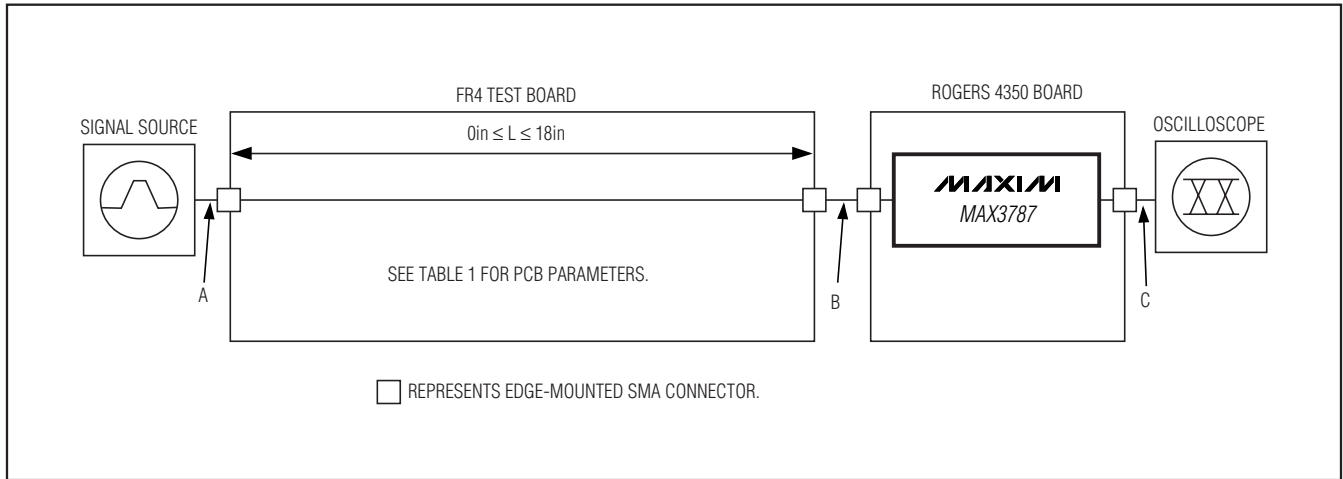

Figure 1. Residual Deterministic Jitter Test Circuit

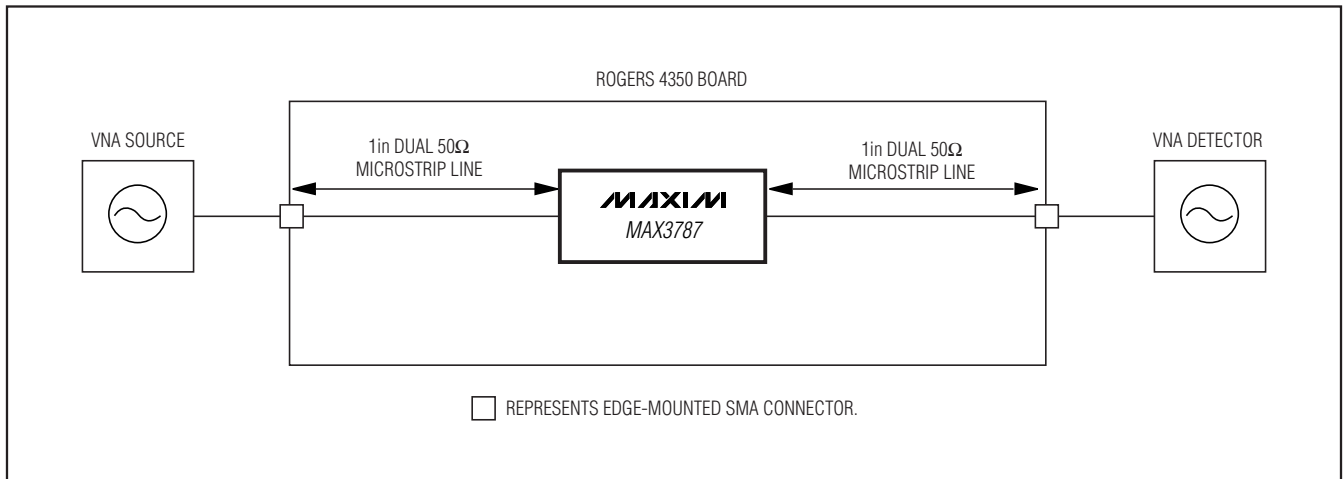

Figure 2. Frequency Response Test Circuit Using Vector Network Analyzer (VNA)

# 1Gbps to 12.5Gbps Passive Equalizer for Backplanes and Cables

| FREQUENCY | MIN (dB) | TYP (dB) | MAX (dB) |
|-----------|----------|----------|----------|
| 100MHz    | -8.2     | -7.4     | -6.8     |
| 200MHz    | -7.9     | -7.0     | -6.4     |
| 300MHz    | -7.5     | -6.6     | -6.0     |
| 500MHz    | -6.8     | -6.0     | -5.3     |
| 1.0GHz    | -5.5     | -4.8     | -4.2     |
| 2.0GHz    | -4.2     | -3.2     | -2.5     |
| 3.0GHz    | -3.1     | -2.2     | -1.5     |
| 4.0GHz    | -2.3     | -1.5     | -0.8     |
| 5.0GHz    | -2.1     | -1.3     | -0.5     |
| 5.5GHz    | -2.4     | -1.6     | -0.6     |
| 6.0GHz    | -2.9     | -2.1     | -1.1     |
| 6.5GHz    | —        | -2.6     | —        |
| 7.0GHz    | —        | -3.1     | —        |
| 7.5GHz    | —        | -3.6     | —        |
| 8.0GHz    | —        | -4.1     | —        |
| 8.5GHz    | —        | -4.7     | —        |
| 9.0GHz    | —        | -5.5     | —        |
| 9.5GHz    | —        | -7.0     | —        |
| 10.0GHz   | —        | -9.0     | —        |

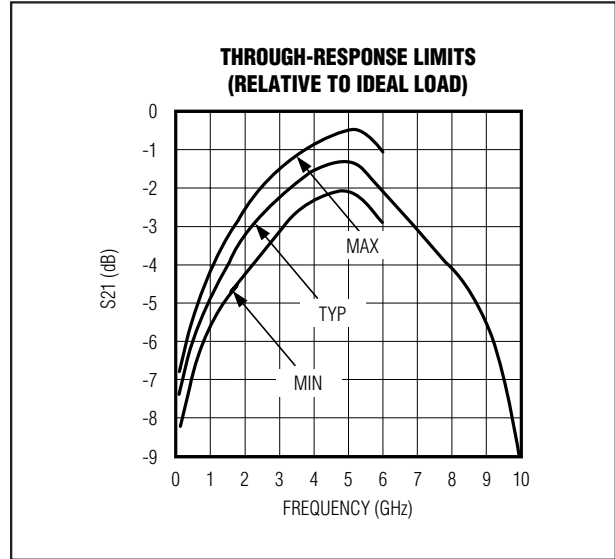

Figure 3. Through Response Limits

Table 1. PCB Assumptions (Board Material is FR4)

| PARAMETER                     | CONDITIONS                   | MIN | TYP  | MAX | UNITS    |
|-------------------------------|------------------------------|-----|------|-----|----------|
| Transmission Line             | Edge-coupled microstrip line |     | 6    |     | mil      |
| Relative Permittivity at 1GHz | FR4 or similar               |     | 4.0  |     | —        |
| Loss Tangent                  | FR4 or similar               |     | 0.02 |     | —        |
| Metal Thickness               | 1oz copper                   |     | 1.4  |     | mil      |
| Impedance                     | Differential                 | 90  | 100  | 110 | $\Omega$ |

# 1Gbps to 12.5Gbps Passive Equalizer for Backplanes and Cables

MAX3787

## Typical Operating Characteristics

( $T_A = +25^\circ\text{C}$ , unless otherwise noted. All measurements were done with  $1V_{P-P}$  at the source. Stress pattern:  $2^7$  PRBS, 100 zeros, 1, 0, 1, 0, 27 PRBS, 100 ones, 0, 1, 0, 1. Residual deterministic jitter graphs were measured using Tektronix's FrameScan®. Deterministic jitter of the system was subtracted from the measured value. Eye diagrams acquired by FrameScan include deterministic jitter of the system (approximately 9ps) but not random jitter. Twin-ax cable: Amphenol Spectra-Strip® Skewclear® 100Ω 24AWG.)

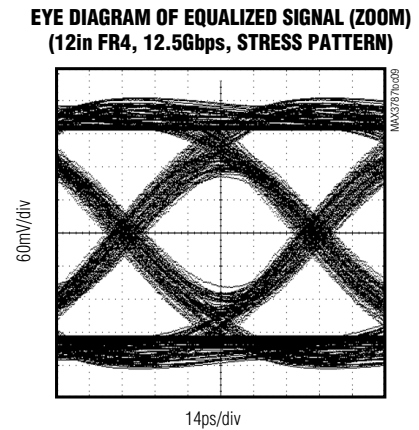
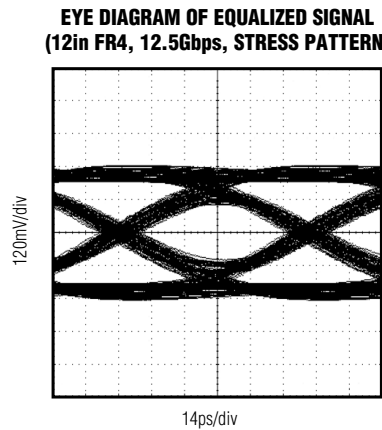
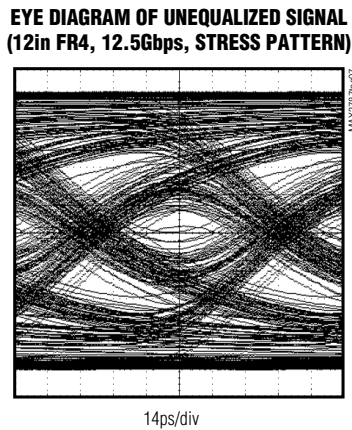
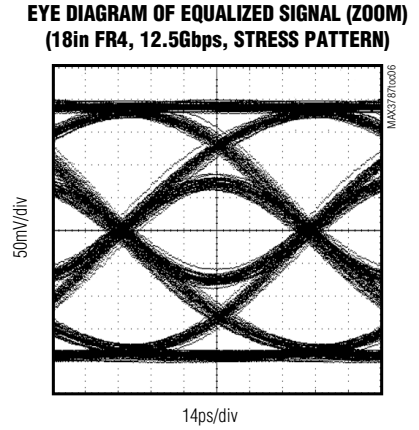
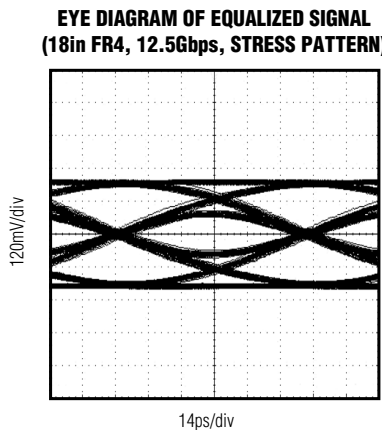
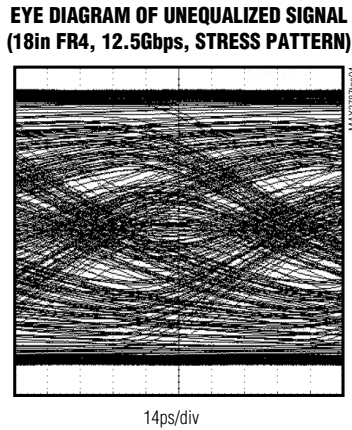
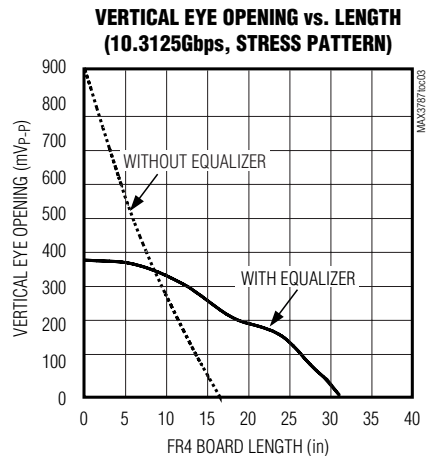
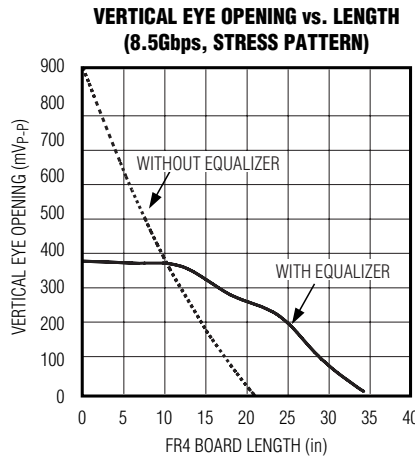
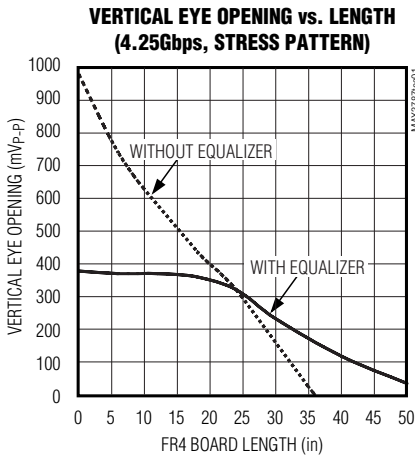

FrameScan is a registered trademark of Tektronix.  
Spectra-Strip and Skewclear are registered trademarks of Amphenol.

# 1Gbps to 12.5Gbps Passive Equalizer for Backplanes and Cables

## Typical Operating Characteristics (continued)

( $T_A = +25^\circ\text{C}$ , unless otherwise noted. All measurements were done with  $1V_{P-P}$  at the source. Stress pattern:  $2^7$  PRBS, 100 zeros, 1, 0, 1, 0, 27 PRBS, 100 ones, 0, 1, 0, 1. Residual deterministic jitter graphs were measured using Tektronix's FrameScan. Deterministic jitter of the system was subtracted from the measured value. Eye diagrams acquired by FrameScan include deterministic jitter of the system (approximately 9ps) but not random jitter. Twin-ax cable: Amphenol Spectra-Strip Skewclear  $100\Omega$  24AWG.)

**EYE DIAGRAM OF UNEQUALIZED SIGNAL  
(18in FR4, 10.3125Gbps, STRESS PATTERN)**

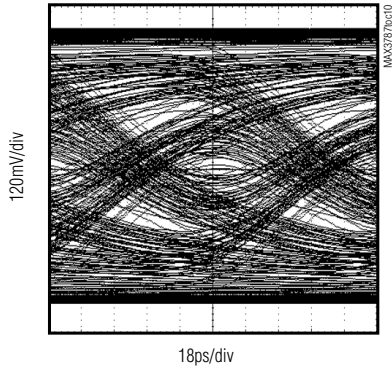

**EYE DIAGRAM OF EQUALIZED SIGNAL  
(18in FR4, 10.3125Gbps, STRESS PATTERN)**

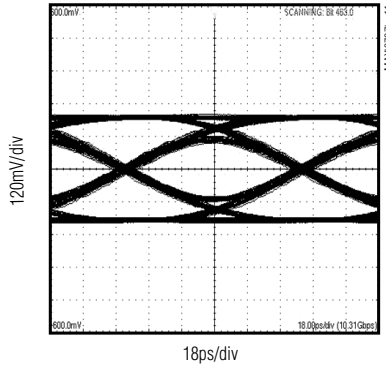

**EYE DIAGRAM OF EQUALIZED SIGNAL (ZOOM)  
(18in FR4, 10.3125Gbps, STRESS PATTERN)**

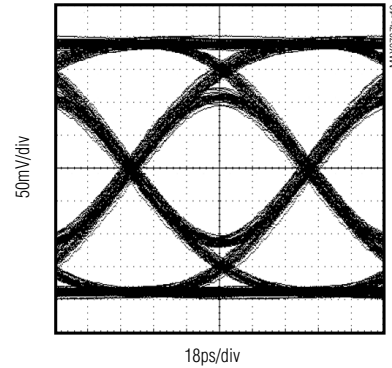

**EYE DIAGRAM OF UNEQUALIZED SIGNAL  
(12in FR4, 10.3125Gbps, STRESS PATTERN)**

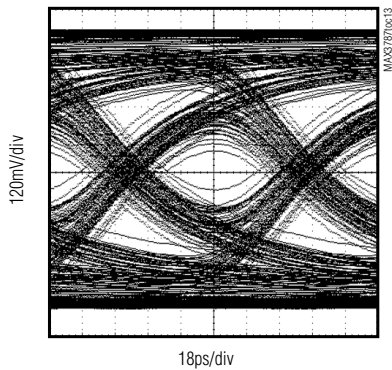

**EYE DIAGRAM OF EQUALIZED SIGNAL  
(12in FR4, 10.3125Gbps, STRESS PATTERN)**

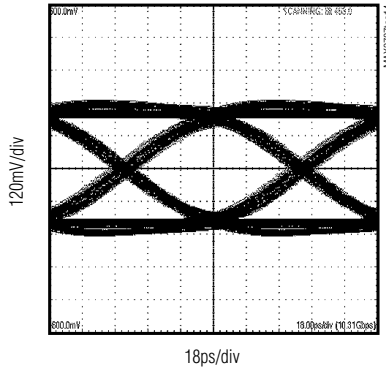

**EYE DIAGRAM OF EQUALIZED SIGNAL (ZOOM)  
(12in FR4, 10.3125Gbps, STRESS PATTERN)**

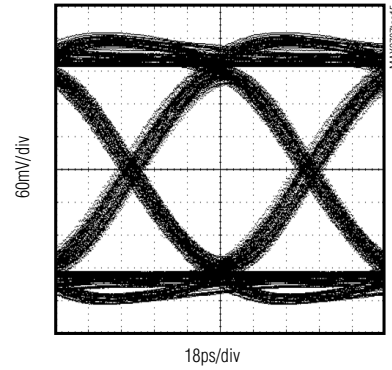

**EYE DIAGRAM OF UNEQUALIZED SIGNAL  
(18in FR4, 8.5Gbps, STRESS PATTERN)**

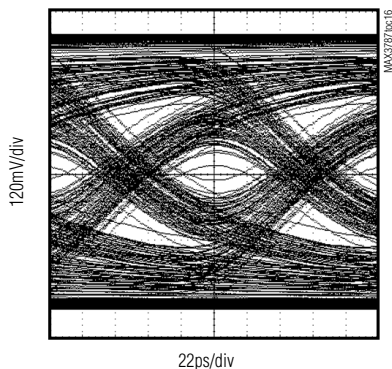

**EYE DIAGRAM OF EQUALIZED SIGNAL  
(18in FR4, 8.5Gbps, STRESS PATTERN)**

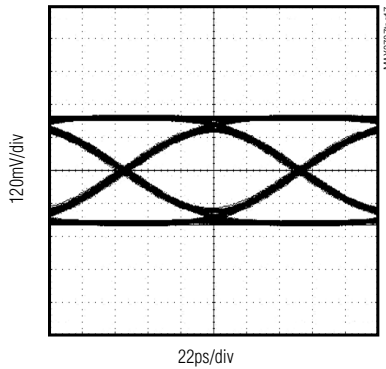

**EYE DIAGRAM OF EQUALIZED SIGNAL (ZOOM)  
(18in FR4, 8.5Gbps, STRESS PATTERN)**

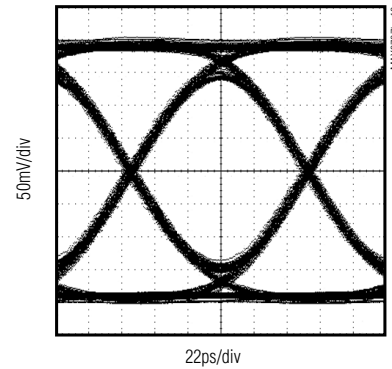

# 1Gbps to 12.5Gbps Passive Equalizer for Backplanes and Cables

## Typical Operating Characteristics (continued)

MAX3787

( $T_A = +25^\circ\text{C}$ , unless otherwise noted. All measurements were done with  $1V_{P-P}$  at the source. Stress pattern:  $2^7$  PRBS, 100 zeros, 1, 0, 1, 0,  $2^7$  PRBS, 100 ones, 0, 1, 0, 1. Residual deterministic jitter graphs were measured using Tektronix's FrameScan. Deterministic jitter of the system was subtracted from the measured value. Eye diagrams acquired by FrameScan include deterministic jitter of the system (approximately 9ps) but not random jitter. Twin-ax cable: Amphenol Spectra-Strip Skewclear  $100\Omega$  24AWG.)

**EYE DIAGRAM OF UNEQUALIZED SIGNAL  
(12in FR4, 8.5Gbps, STRESS PATTERN)**

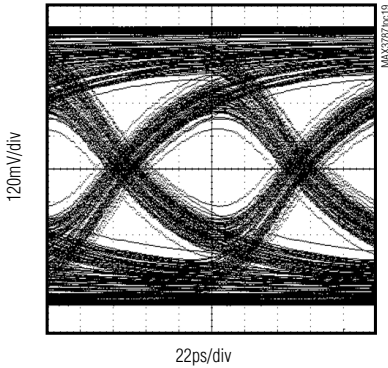

**EYE DIAGRAM OF EQUALIZED SIGNAL  
(12in FR4, 8.5Gbps, STRESS PATTERN)**

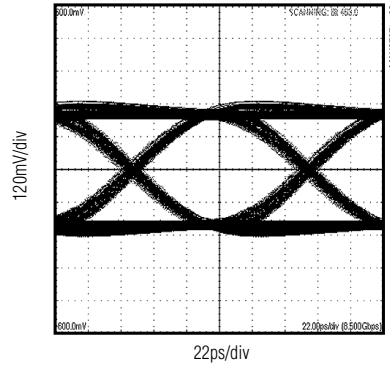

**EYE DIAGRAM OF EQUALIZED SIGNAL (ZOOM)  
(12in FR4, 8.5Gbps, STRESS PATTERN)**

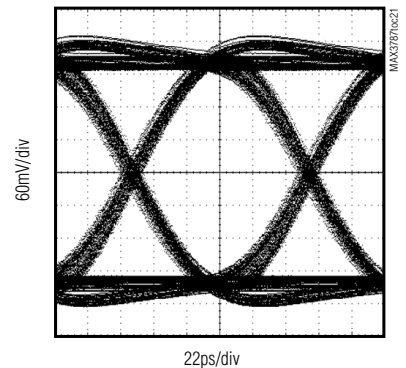

**EYE DIAGRAM OF UNEQUALIZED SIGNAL  
(18in FR4, 6.25Gbps, STRESS PATTERN)**

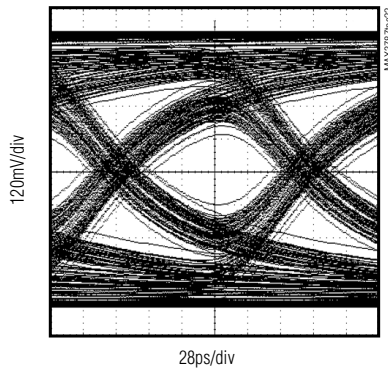

**EYE DIAGRAM OF EQUALIZED SIGNAL  
(18in FR4, 6.25Gbps, STRESS PATTERN)**

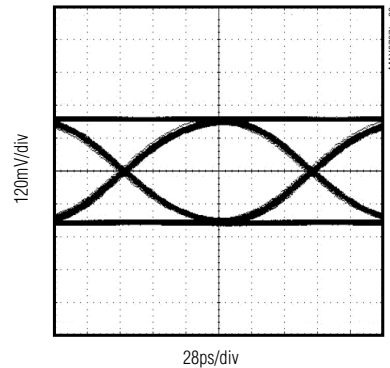

**EYE DIAGRAM OF EQUALIZED SIGNAL (ZOOM)  
(18in FR4, 6.25Gbps, STRESS PATTERN)**

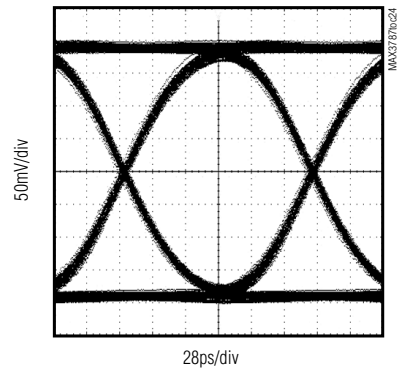

**EYE DIAGRAM OF UNEQUALIZED SIGNAL  
(12in FR4, 6.25Gbps, STRESS PATTERN)**

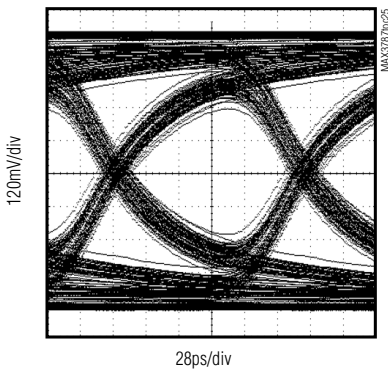

**EYE DIAGRAM OF EQUALIZED SIGNAL  
(12in FR4, 6.25Gbps, STRESS PATTERN)**

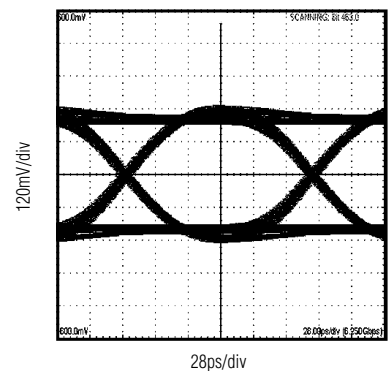

**EYE DIAGRAM OF EQUALIZED SIGNAL (ZOOM)  
(12in FR4, 6.25Gbps, STRESS PATTERN)**

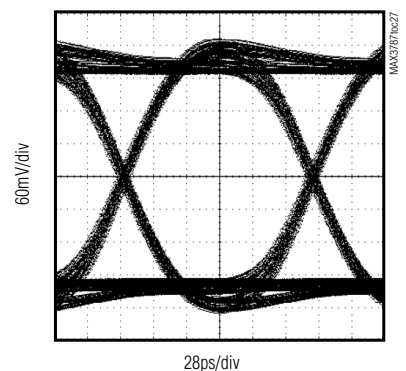

# 1Gbps to 12.5Gbps Passive Equalizer for Backplanes and Cables

## Typical Operating Characteristics (continued)

( $T_A = +25^\circ\text{C}$ , unless otherwise noted. All measurements were done with  $1V_{P-P}$  at the source. Stress pattern:  $2^7$  PRBS, 100 zeros, 1, 0, 1, 0,  $2^7$  PRBS, 100 ones, 0, 1, 0, 1. Residual deterministic jitter graphs were measured using Tektronix's FrameScan. Deterministic jitter of the system was subtracted from the measured value. Eye diagrams acquired by FrameScan include deterministic jitter of the system (approximately 9ps) but not random jitter. Twin-ax cable: Amphenol Spectra-Strip Skewclear 100 $\Omega$  24AWG.)

**EYE DIAGRAM OF UNEQUALIZED SIGNAL  
(18in FR4, 4.25Gbps, STRESS PATTERN)**

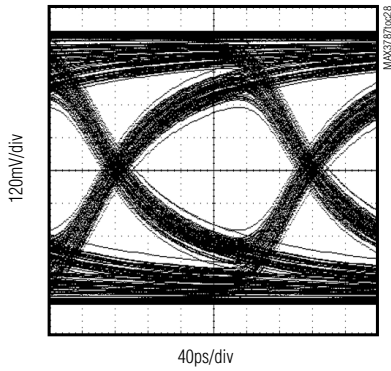

**EYE DIAGRAM OF EQUALIZED SIGNAL  
(18in FR4, 4.25Gbps, STRESS PATTERN)**

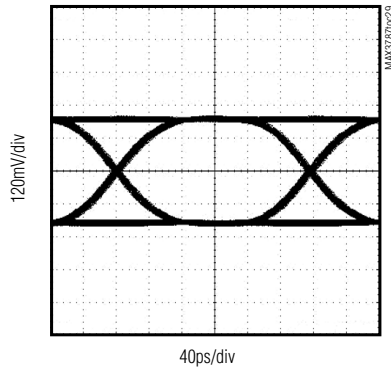

**EYE DIAGRAM OF EQUALIZED SIGNAL (ZOOM)  
(18in FR4, 4.25Gbps, STRESS PATTERN)**

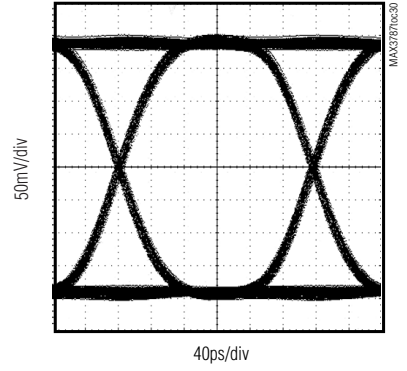

**EYE DIAGRAM OF UNEQUALIZED SIGNAL  
(12in FR4, 4.25Gbps, STRESS PATTERN)**

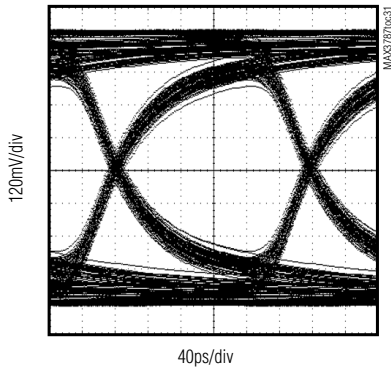

**EYE DIAGRAM OF EQUALIZED SIGNAL  
(12in FR4, 4.25Gbps, STRESS PATTERN)**

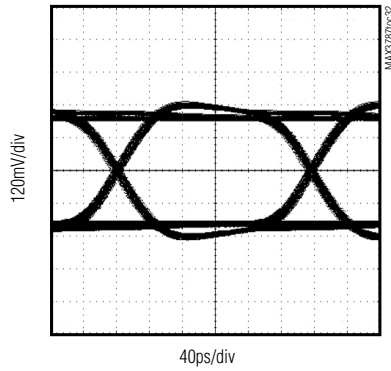

**EYE DIAGRAM OF EQUALIZED SIGNAL (ZOOM)  
(12in FR4, 4.25Gbps, STRESS PATTERN)**

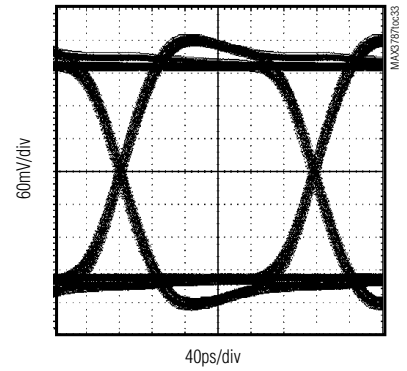

**EYE DIAGRAM OF UNEQUALIZED SIGNAL  
(5m TWIN-AX CABLE, 10.3125Gbps, STRESS PATTERN)**

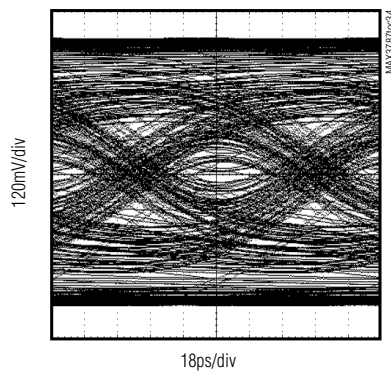

**EYE DIAGRAM OF EQUALIZED SIGNAL  
(5m TWIN-AX CABLE, 10.3125Gbps, STRESS PATTERN)**

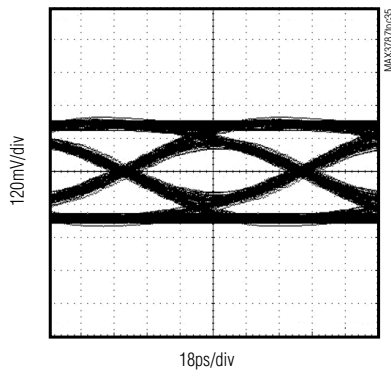

**EYE DIAGRAM OF EQUALIZED SIGNAL (ZOOM)  
(5m TWIN-AX CABLE, 10.3125Gbps, STRESS PATTERN)**

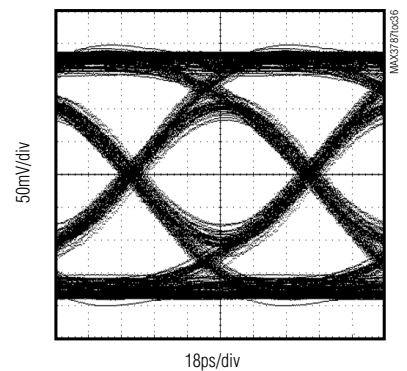

# 1Gbps to 12.5Gbps Passive Equalizer for Backplanes and Cables

## Typical Operating Characteristics (continued)

( $T_A = +25^\circ\text{C}$ , unless otherwise noted. All measurements were done with  $1V_{P-P}$  at the source. Stress pattern:  $2^7$  PRBS, 100 zeros, 1, 0, 1, 0, 27 PRBS, 100 ones, 0, 1, 0, 1. Residual deterministic jitter graphs were measured using Tektronix's FrameScan. Deterministic jitter of the system was subtracted from the measured value. Eye diagrams acquired by FrameScan which include deterministic jitter of the system (approximately 9ps) but not random jitter. Twin-ax cable: Amphenol Spectra-Strip Skewclear  $100\Omega$  24AWG.)

MAX3787

**EYE DIAGRAM OF UNEQUALIZED SIGNAL**  
(3m TWIN-AX CABLE, 10.3125Gbps,  
STRESS PATTERN)

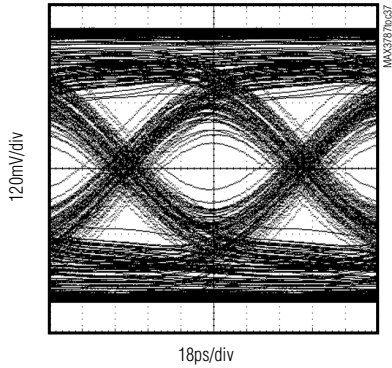

**EYE DIAGRAM OF EQUALIZED SIGNAL**  
(3m TWIN-AX CABLE, 10.3125Gbps,  
STRESS PATTERN)

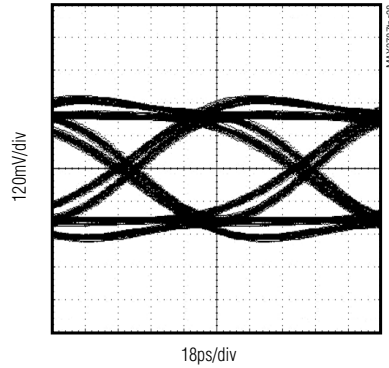

**EYE DIAGRAM OF EQUALIZED SIGNAL (ZOOM)**  
(3m TWIN-AX CABLE, 10.3125Gbps,  
STRESS PATTERN)

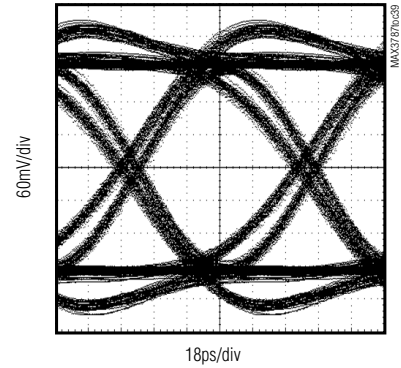

**EYE DIAGRAM OF UNEQUALIZED SIGNAL**  
(7m TWIN-AX CABLE, 8.5Gbps,  
STRESS PATTERN)

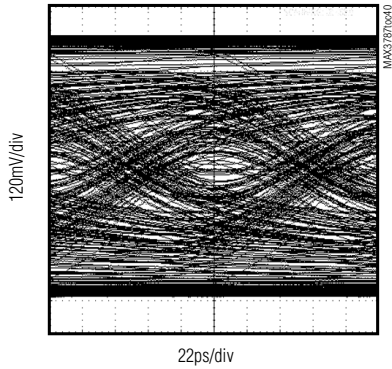

**EYE DIAGRAM OF EQUALIZED SIGNAL**  
(7m TWIN-AX CABLE, 8.5Gbps,  
STRESS PATTERN)

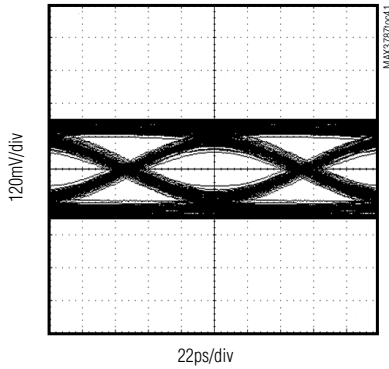

**EYE DIAGRAM OF EQUALIZED SIGNAL (ZOOM)**  
(7m TWIN-AX CABLE, 8.5Gbps,  
STRESS PATTERN)

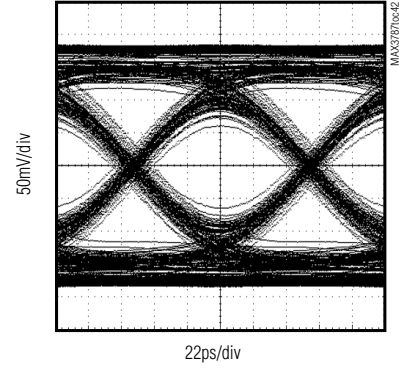

**EYE DIAGRAM OF UNEQUALIZED SIGNAL**  
(5m TWIN-AX CABLE, 8.5Gbps,  
STRESS PATTERN)

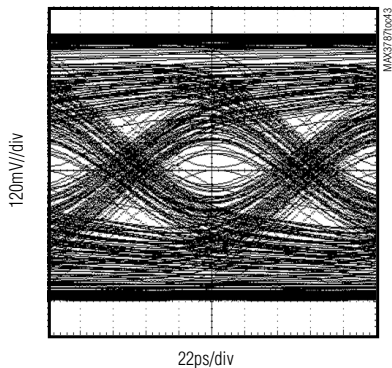

**EYE DIAGRAM OF EQUALIZED SIGNAL**  
(5m TWIN-AX CABLE, 8.5Gbps,  
STRESS PATTERN)

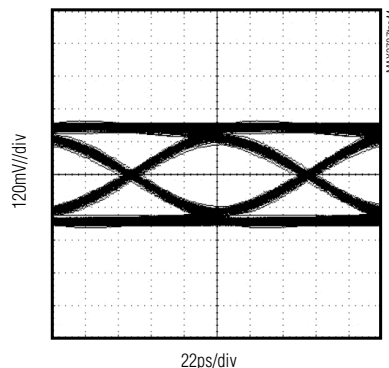

**EYE DIAGRAM OF EQUALIZED SIGNAL (ZOOM)**  
(5m TWIN-AX CABLE, 8.5Gbps,  
STRESS PATTERN)

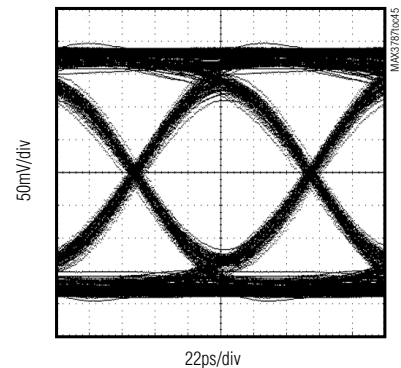

# 1Gbps to 12.5Gbps Passive Equalizer for Backplanes and Cables

## Typical Operating Characteristics (continued)

( $T_A = +25^\circ\text{C}$ , unless otherwise noted. All measurements were done with  $1V_{P-P}$  at the source. Stress pattern:  $2^7$  PRBS, 100 zeros, 1, 0, 1, 0, 1, 0, 27 PRBS, 100 ones, 0, 1, 0, 1. Residual deterministic jitter graphs were measured using Tektronix's FrameScan. Deterministic jitter of the system was subtracted from the measured value. Eye diagrams acquired by FrameScan include deterministic jitter of the system (approximately 9ps) but not random jitter. Twin-ax cable: Amphenol Spectra-Strip Skewclear 100 $\Omega$  24AWG.)

**EYE DIAGRAM OF UNEQUALIZED SIGNAL  
(7m TWIN-AX CABLE, 4.25Gbps,  
STRESS PATTERN)**

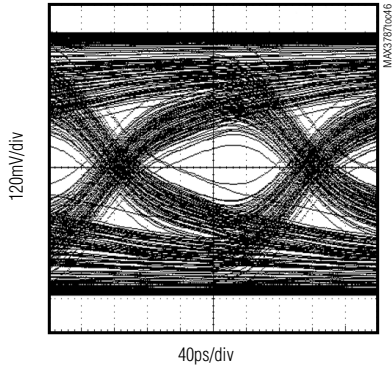

**EYE DIAGRAM OF EQUALIZED SIGNAL  
(7m TWIN-AX CABLE, 4.25Gbps,  
STRESS PATTERN)**

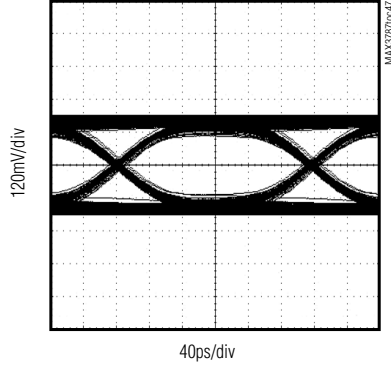

**EYE DIAGRAM OF EQUALIZED SIGNAL (ZOOM)  
(7m TWIN-AX CABLE, 4.25Gbps,  
STRESS PATTERN)**

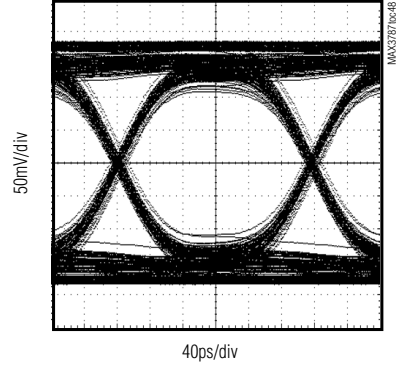

**EYE DIAGRAM OF UNEQUALIZED SIGNAL  
(5m TWIN-AX CABLE, 4.25Gbps,  
STRESS PATTERN)**

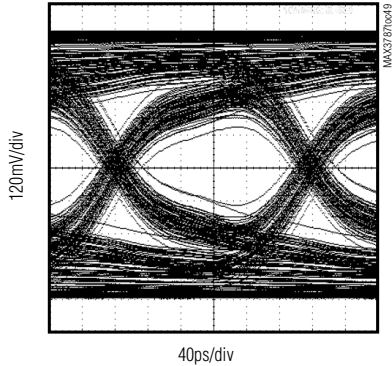

**EYE DIAGRAM OF EQUALIZED SIGNAL  
(5m TWIN-AX CABLE, 4.25Gbps,  
STRESS PATTERN)**

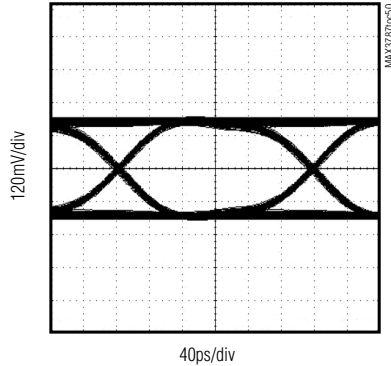

**EYE DIAGRAM OF EQUALIZED SIGNAL (ZOOM)  
(5m TWIN-AX CABLE, 4.25Gbps,  
STRESS PATTERN)**

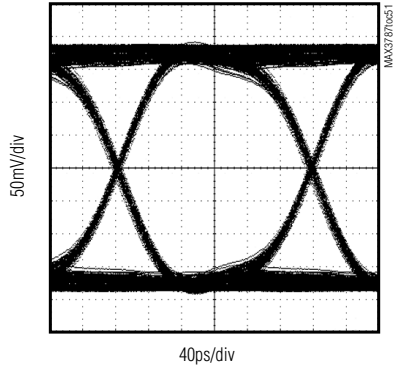

**EYE DIAGRAM OF EQUALIZED SIGNAL  
(0in FR4, 1Gbps, STRESS PATTERN)**

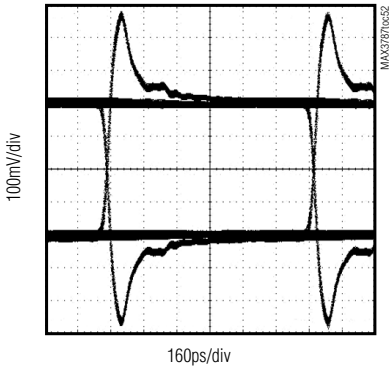

**EYE DIAGRAM OF EQUALIZED SIGNAL  
(0in FR4, 5Gbps, STRESS PATTERN)**

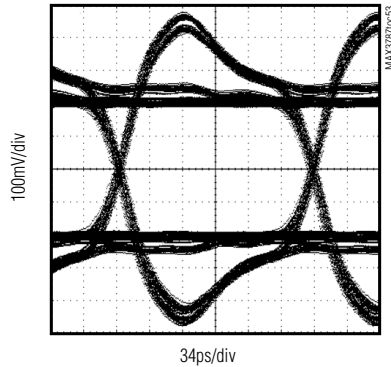

**EYE DIAGRAM OF EQUALIZED SIGNAL  
(0in FR4, 10Gbps, STRESS PATTERN)**

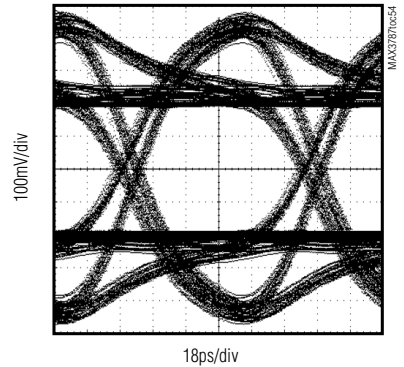

# 1Gbps to 12.5Gbps Passive Equalizer for Backplanes and Cables

MAX3787

## Typical Operating Characteristics (continued)

( $T_A = +25^\circ\text{C}$ , unless otherwise noted. All measurements were done with  $1V_{P-P}$  at the source. Stress pattern:  $2^7$  PRBS, 100 zeros, 1, 0, 1, 0,  $2^7$  PRBS, 100 ones, 0, 1, 0, 1. Residual deterministic jitter graphs were measured using Tektronix's FrameScan. Deterministic jitter of the system was subtracted from the measured value. Eye diagrams acquired by FrameScan include deterministic jitter of the system (approximately 9ps) but not random jitter. Twin-ax cable: Amphenol Spectra-Strip Skewclear  $100\Omega$  24AWG.)

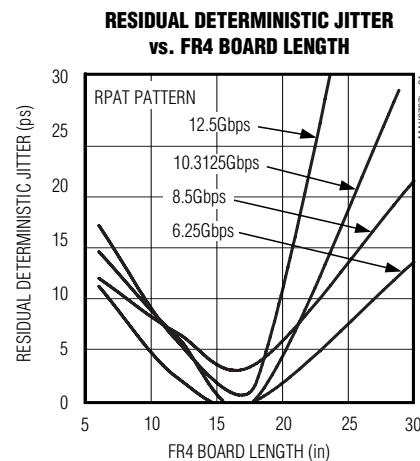
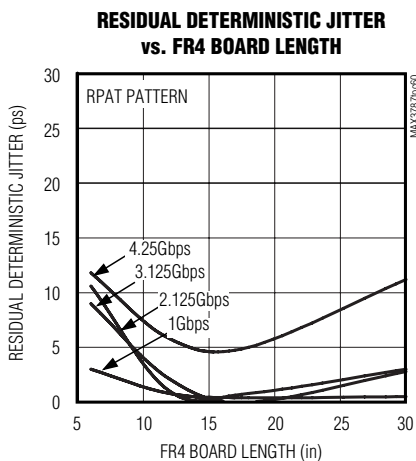
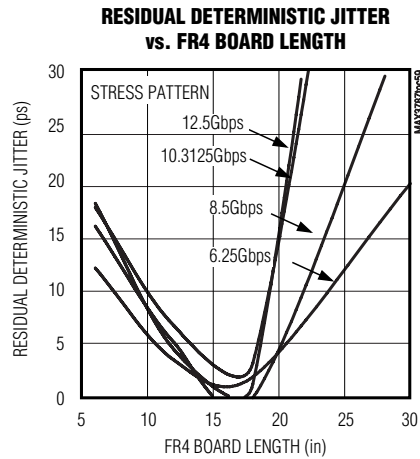
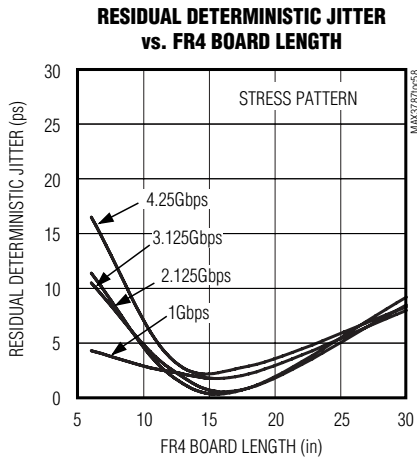
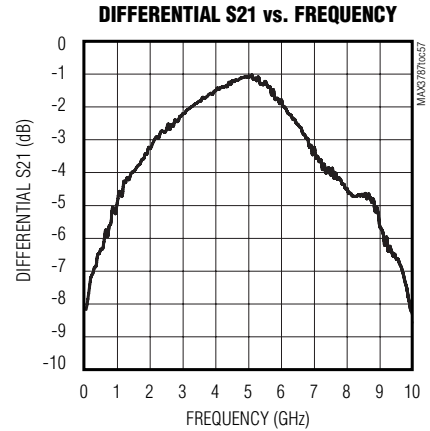
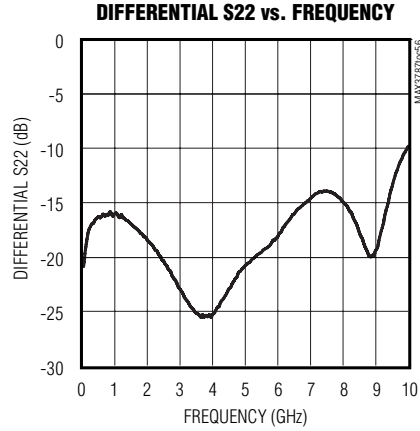
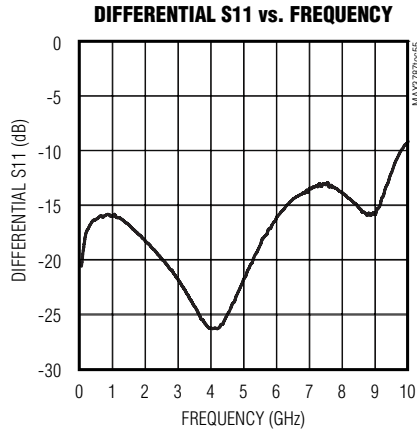

# 1Gbps to 12.5Gbps Passive Equalizer for Backplanes and Cables

## Typical Operating Characteristics (continued)

( $T_A = +25^\circ\text{C}$ , unless otherwise noted. All measurements were done with  $1V_{P-P}$  at the source. Stress pattern:  $2^7$  PRBS, 100 zeros, 1, 0, 1, 0, 27 PRBS, 100 ones, 0, 1, 0, 1. Residual deterministic jitter graphs were measured using Tektronix's FrameScan. Deterministic jitter of the system was subtracted from the measured value. Eye diagrams acquired by FrameScan include deterministic jitter of the system (approximately 9ps) but not random jitter. Twin-ax cable: Amphenol Spectra-Strip Skewclear 100 $\Omega$  24AWG.)

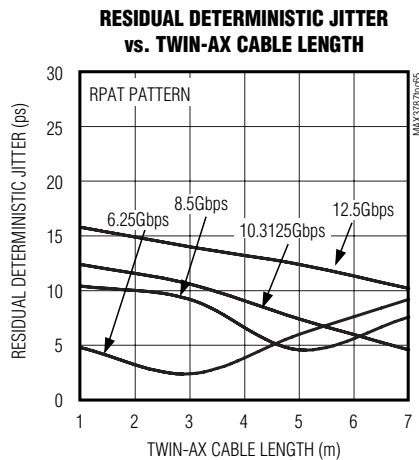
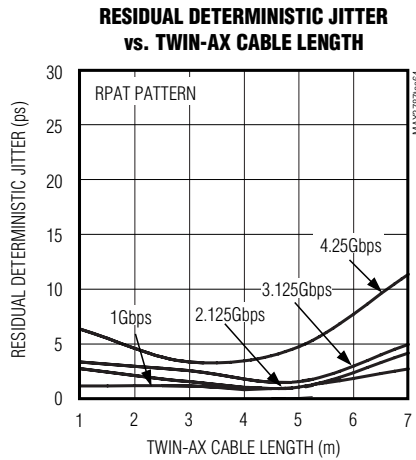
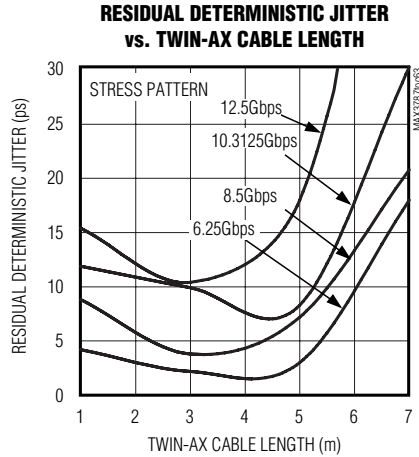
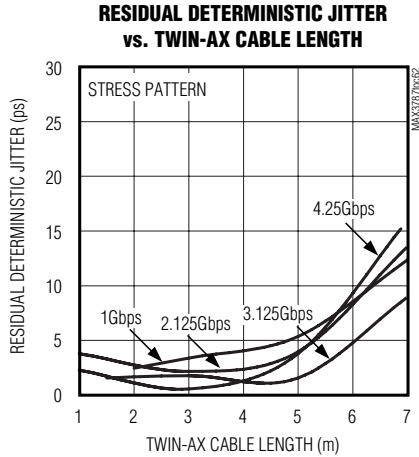

# 1Gbps to 12.5Gbps Passive Equalizer for Backplanes and Cables

## Pin Description

MAX3787

| PIN | NAME | FUNCTION             |
|-----|------|----------------------|
| A1  | IN+  | Positive Data Input  |
| A3  | OUT+ | Positive Data Output |
| C1  | IN-  | Negative Data Input  |
| C3  | OUT- | Negative Data Output |

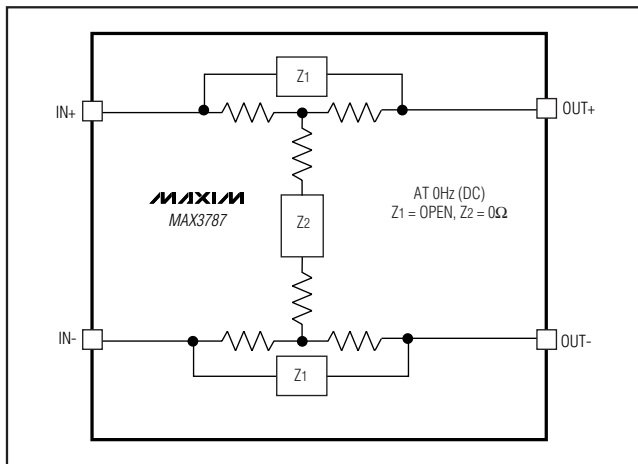

Figure 4. Functional Diagram

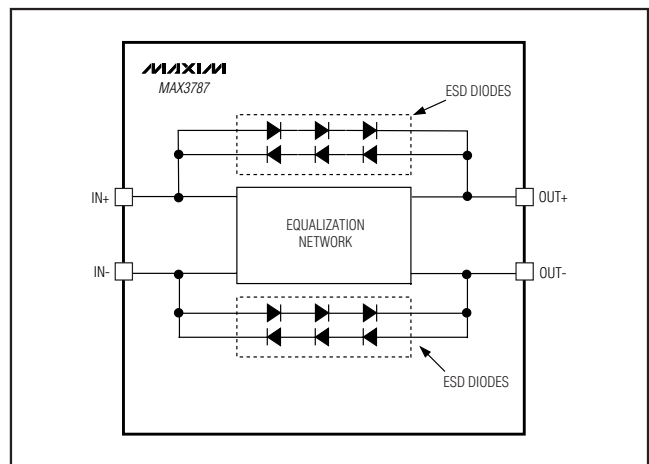

Figure 5. ESD Protection Diodes

## Detailed Description

The MAX3787 is an entirely passive network composed of both resistive and reactive components (Figure 4). Two symmetric-T networks with bypassing for high-pass characteristics are used to create a differential symmetric-H network. The entire network acts as a filter specifically tuned to compensate for transmission medium losses encountered with FR4 and cables.

### Input and Output Terminations

The MAX3787 input impedance is 100Ω differential with the output connected to a 100Ω differential load. The network is designed for 100Ω-balanced differential signals and is not intended for single-ended transmission.

### ESD Protection Diodes

The MAX3787 contains ESD diodes that bypass the equalization network in case of static discharge (Figure 5).

## Applications Information

### Equalizer Integration and Placement

The MAX3787 is packaged in a small 1.5mm x 1.5mm UCSP that can be placed anywhere along the transmission medium. The small size allows placement and routing flexibility.

Due to the symmetry of the equalization network, signals can pass from IN to OUT or OUT to IN with the same compensation. The equalizer can also be placed at the beginning or end of the transmission medium and provide the same compensation at the receiving circuit. For example, two equalizers can be placed in one transceiver module, one for the transmit path and one for the receive path (see *Typical Application Circuits*).

### UCSP Assembly Considerations

For the latest application details on UCSP construction, dimensions, tape carrier information, PCB techniques, bump-pad layout, and recommended reflow temperature profile, as well as the latest information on reliability testing results, refer to Application Note 1891: *UCSP-A Wafer-Level Chip-Scale Package* available on Maxim's website at [www.maxim-ic.com/ucsp](http://www.maxim-ic.com/ucsp).

## Chip Information

TRANSISTOR COUNT: 0

PROCESS: SiGe BiPOLAR

# 1Gbps to 12.5Gbps Passive Equalizer for Backplanes and Cables

## Typical Application Circuits (continued)

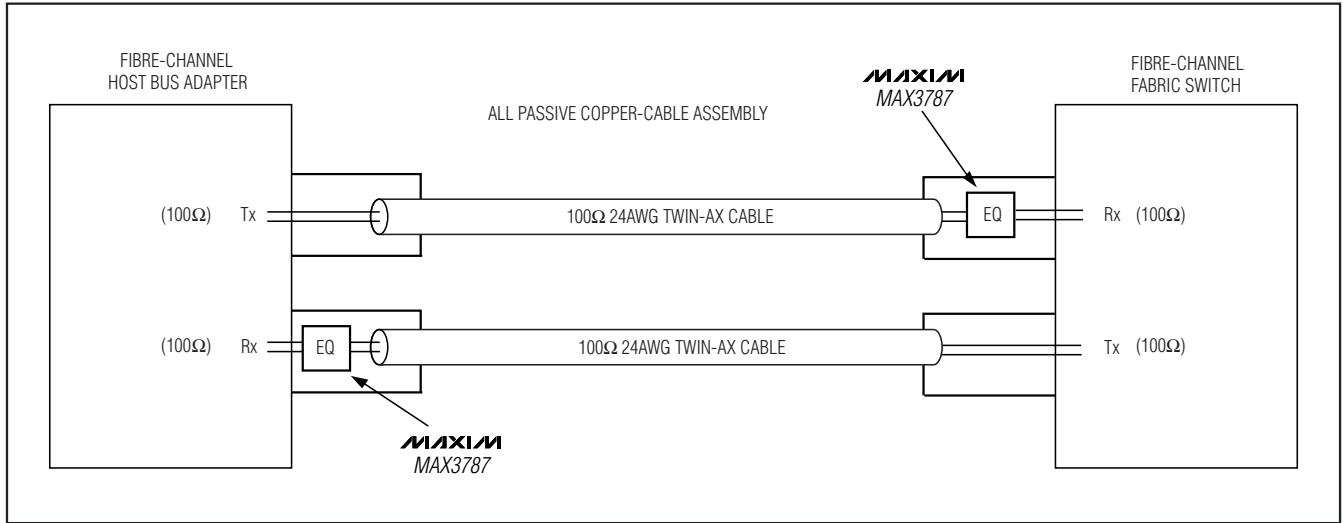

### Package Information

(For the latest package outline information, go to [www.maxim-ic.com/packages](http://www.maxim-ic.com/packages).)

| PACKAGE TYPE | PACKAGE CODE | DOCUMENT NO.            |
|--------------|--------------|-------------------------|
| 4 UCSP       | B9-7         | <a href="#">21-0093</a> |
| 4 WLP        | W91B1+3      | <a href="#">21-0067</a> |

# 1Gbps to 12.5Gbps Passive Equalizer for Backplanes and Cables

## Revision History

| REVISION NUMBER | REVISION DATE | DESCRIPTION  | PAGES CHANGED |
|-----------------|---------------|--|---------------|
| 0               | 7/05          | Initial release.   | —             |
| 1               | 12/05         | Added lead-free package to Ordering Information table.   | 1             |
| 2               | 2/08          | In the Ordering Information table, changed lead-free part number from ABL+ to AWL+; added WLP package information. | 1, 14         |

MAX3787

Maxim cannot assume responsibility for use of any circuitry other than circuitry entirely embodied in a Maxim product. No circuit patent licenses are implied. Maxim reserves the right to change the circuitry and specifications without notice at any time.

Maxim Integrated Products, 120 San Gabriel Drive, Sunnyvale, CA 94086 408-737-7600 \_\_\_\_\_ 15

## Looking for pricing, stock, or lifecycle information?

Click below to explore more details on WIN SOURCE:

 [View MAX3787ABL+T on WIN SOURCE](#)

 [Maxim Integrated](#) Information

## Optimize Your Supply Chain with WIN SOURCE Solutions

-  Global Sourcing Solution
-  Obsolete Management
-  Cost Control Management
-  Shortage Management
-  Alternative Solution
-  Excess Inventory Management