



2SC4853A

RF Transistor 6V, 15mA, $f_T=5\text{GHz}$, NPN Single MCP

ON Semiconductor®

<http://onsemi.com>

Features

- Low-voltage, low-current operation : $f_T=5\text{GHz}$ typ
 $(V_{CE}=1\text{V}, I_C=1\text{mA}) : |S_{21e}|^2=7\text{dB}$ typ ($f=1\text{GHz}$)
 $: NF=2.6\text{dB}$ typ ($f=1\text{GHz}$)

Specifications

Absolute Maximum Ratings at $T_a=25^\circ\text{C}$

Parameter	Symbol	Conditions	Ratings	Unit
Collector-to-Base Voltage	V_{CBO}		12	V
Collector-to-Emitter Voltage	V_{CEO}		6	V
Emitter-to-Base Voltage	V_{EBO}		1.5	V
Collector Current	I_C		15	mA
Collector Dissipation	P_C		90	mW
Junction Temperature	T_j		150	$^\circ\text{C}$
Storage Temperature	T_{stg}		-55 to +150	$^\circ\text{C}$

Stresses exceeding Maximum Ratings may damage the device. Maximum Ratings are stress ratings only. Functional operation above the Recommended Operating Conditions is not implied. Extended exposure to stresses above the Recommended Operating Conditions may affect device reliability.

Package Dimensions

unit : mm (typ)

7023A-009

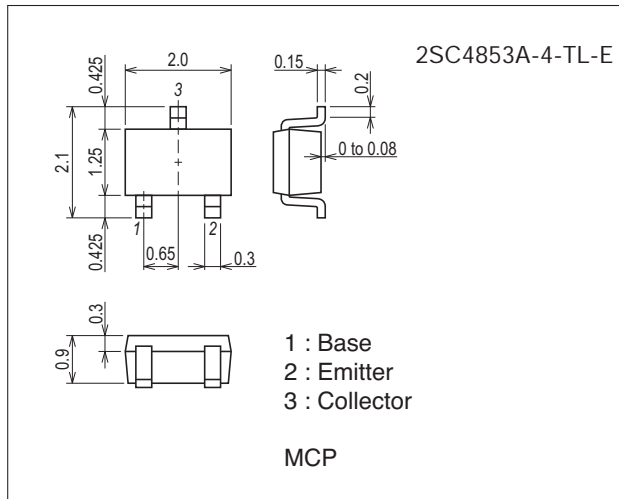

Product & Package Information

- Package : MCP
- JEITA, JEDEC : SC-70, SOT-323
- Minimum Packing Quantity : 3,000 pcs./reel

Packing Type: TL

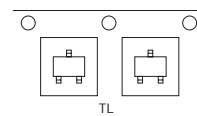

Marking

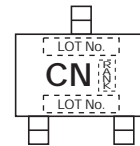

Electrical Connection

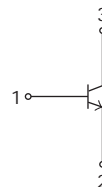

2SC4853A

Electrical Characteristics at Ta=25°C

Parameter	Symbol	Conditions	Ratings			Unit
			min	typ	max	
Collector Cutoff Current	ICBO	V _{CB} =5V, I _E =0A			1.0	μA
Emitter Cutoff Current	I _{EBO}	V _{EB} =1V, I _C =0A			10	μA
DC Current Gain	h _{FE}	V _{CE} =1V, I _C =1mA	60*		270*	
Gain-Bandwidth Product	f _T	V _{CE} =1V, I _C =1mA		5		GHz
Output Capacitance	C _{ob}	V _{CB} =1V, f=1MHz		0.6	1.0	pF
Forward Transfer Gain	S _{21e} ² ₁	V _{CE} =1V, I _C =1mA, f=1GHz	4.5	7		dB
	S _{21e} ² ₂	V _{CE} =2V, I _C =3mA, f=1GHz		10.5		dB
Noise Figure	NF1	V _{CE} =1V, I _C =1mA, f=1GHz		2.6	4.5	dB
	NF2	V _{CE} =2V, I _C =3mA, f=1GHz		1.9		dB

* : The 2SC4853A is classified by 1mA h_{FE} as follows :

Rank	3	4	5
h _{FE}	60 to 120	90 to 180	135 to 270

Ordering Information

Device	Package	Shipping	memo
2SC4853A-4-TL-E	MCP	3,000pcs./reel	Pb Free

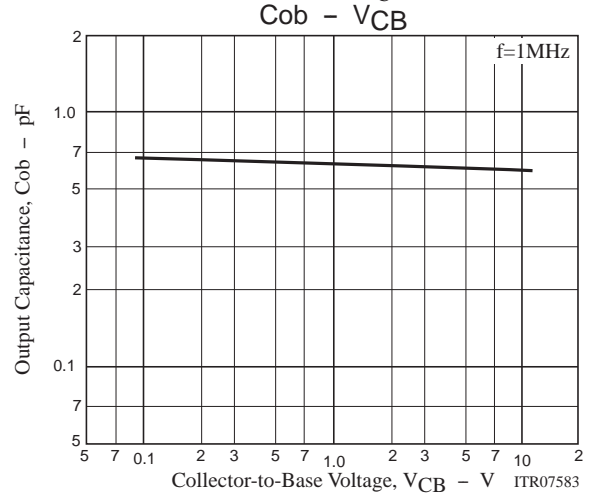
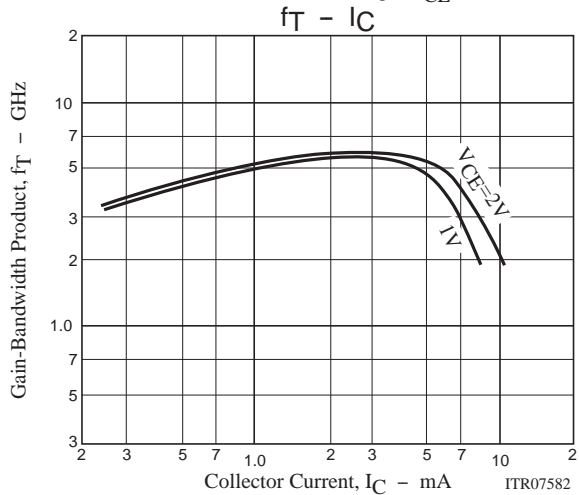
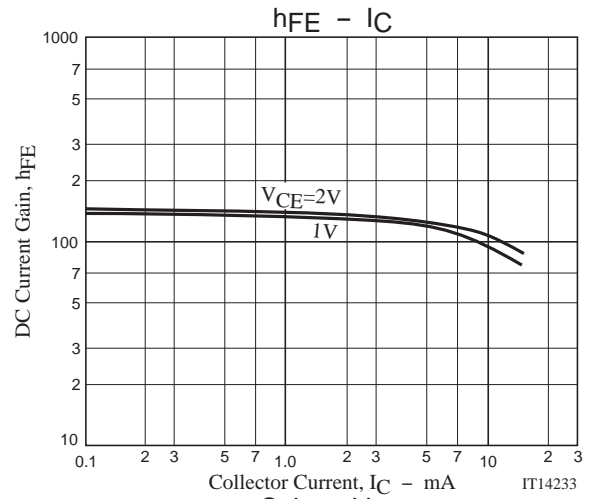
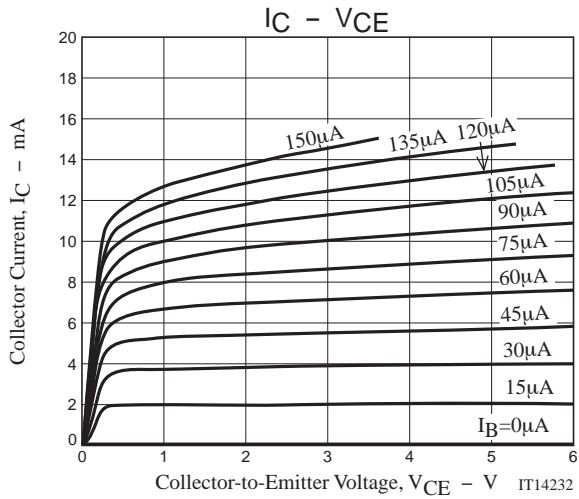

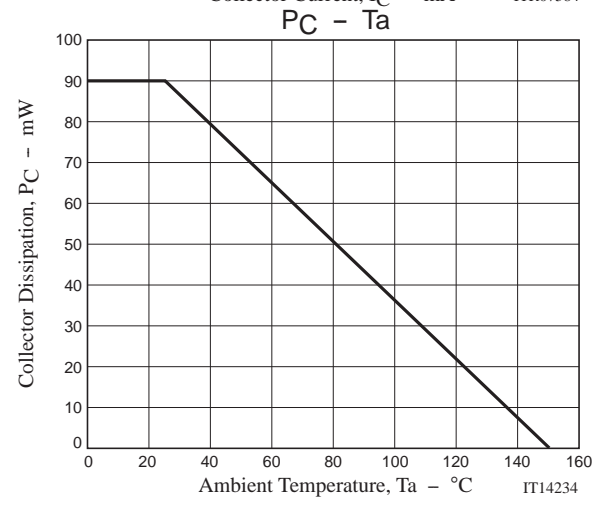
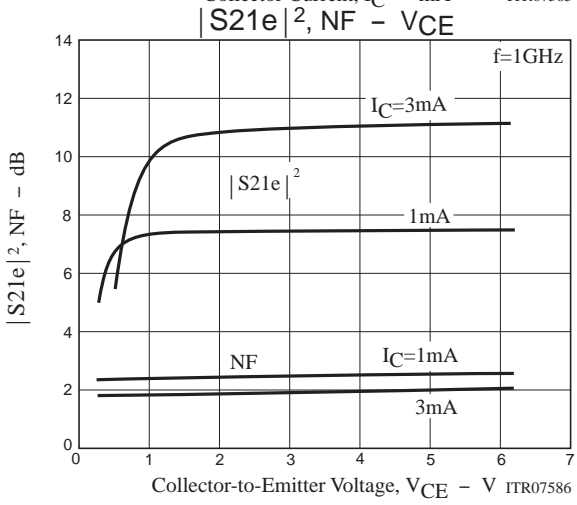
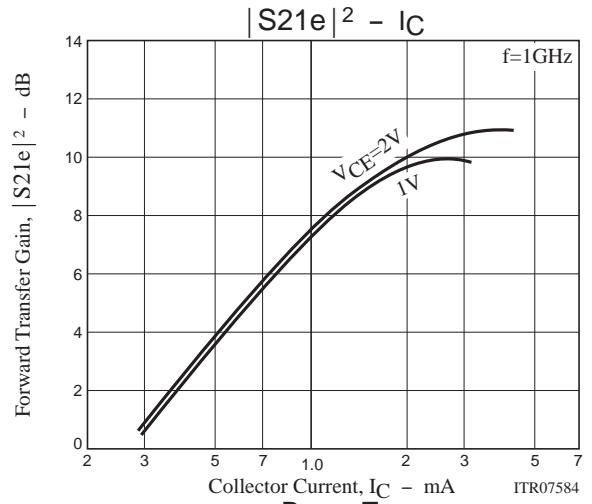
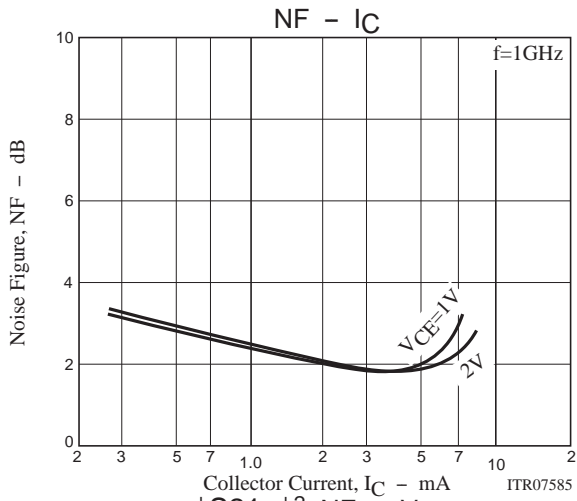

2SC4853A

S Parameters

S11e

f=200MHz to 2000MHz(200MHz Step)

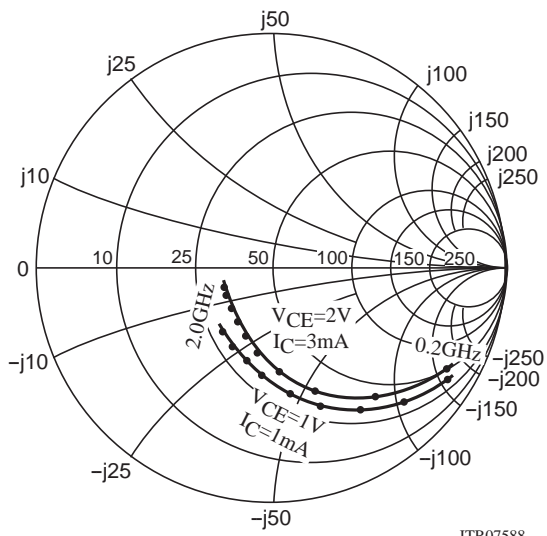

ITR07588

S21e

f=200MHz to 2000MHz(200MHz Step)

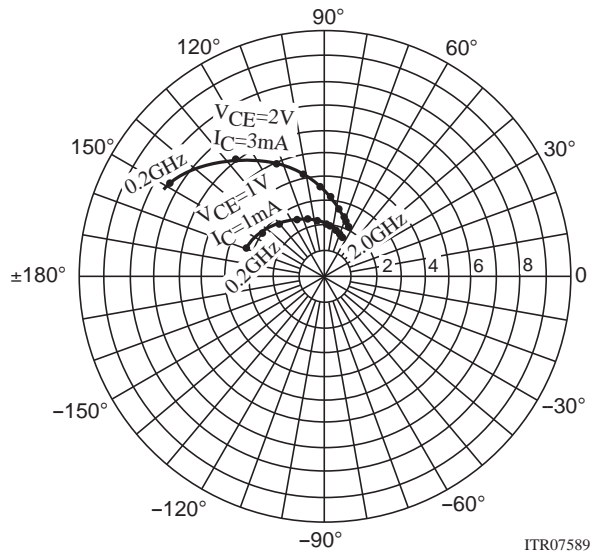

ITR07589

S12e

f=200MHz to 2000MHz(200MHz Step)

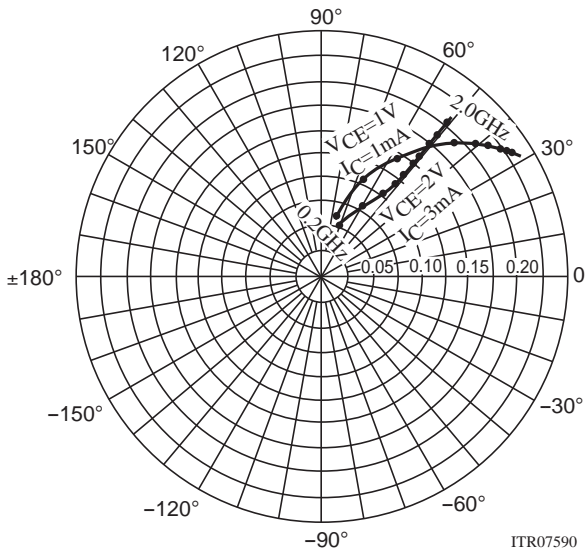

ITR07590

S22e

f=200MHz to 2000MHz(200MHz Step)

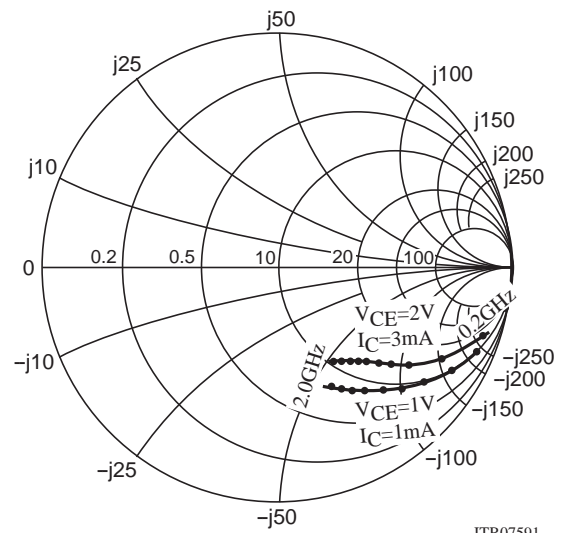

ITR07591

2SC4853A

S Parameters (Common emitter)

$V_{CE}=1V, I_C=1mA, Z_O=50\Omega$

Freq(MHz)	S11	$\angle S11$	S21	$\angle S21$	S12	$\angle S12$	S22	$\angle S22$
200	0.940	-17.9	3.228	159.6	0.058	77.1	0.972	-12.2
400	0.863	-33.7	2.983	143.7	0.107	66.6	0.914	-22.7
600	0.778	-48.0	2.732	129.9	0.145	58.1	0.844	-31.7
800	0.698	-60.5	2.469	117.7	0.173	50.9	0.773	-39.6
1000	0.608	-73.5	2.320	106.2	0.195	45.4	0.717	-46.0
1200	0.546	-84.7	2.106	96.3	0.210	40.9	0.668	-51.7
1400	0.470	-96.2	1.977	87.1	0.129	37.6	0.624	-56.5
1600	0.418	-106.4	1.826	78.8	0.224	35.3	0.590	-60.6
1800	0.388	-117.3	1.700	72.2	0.230	33.8	0.562	-64.3
2000	0.354	-127.0	1.615	65.9	0.234	32.9	0.546	-67.5

$V_{CE}=2V, I_C=3mA, Z_O=50\Omega$

Freq(MHz)	S11	$\angle S11$	S21	$\angle S21$	S12	$\angle S12$	S22	$\angle S22$
200	0.839	-30.6	7.428	149.3	0.050	71.4	0.916	-18.3
400	0.672	-53.7	6.016	128.5	0.083	60.6	0.778	-30.2
600	0.536	-71.7	4.908	113.6	0.105	55.1	0.672	-37.1
800	0.431	-85.7	4.073	101.9	0.121	52.5	0.597	-41.9
1000	0.360	-99.0	3.494	92.7	0.135	51.4	0.548	-45.7
1200	0.310	-111.4	3.033	84.4	0.150	50.9	0.514	-49.2
1400	0.265	-122.6	2.694	77.4	0.162	50.9	0.492	-52.3
1600	0.242	-134.7	2.422	70.9	0.175	51.0	0.475	-55.6
1800	0.228	-148.0	2.205	65.9	0.189	51.1	0.461	-59.0
2000	0.217	-157.2	2.061	60.8	0.205	51.0	0.456	-61.8

Embossed Taping Specification

2SC4853A-4-TL-E

1. Packing Format

Package Name	Carrier Tape Type	Maximum Number of devices contained (pcs)			Packing format	
		Reel	Inner box	Outer box	Inner BOX (C-1)	Outer BOX (A-7)
MCP	MCP	3,000	15,000	90,000	5 reels contained Dimensions:mm (external) 183×72×185	6 inner boxes contained Dimensions:mm (external) 440×195×210

Packing method

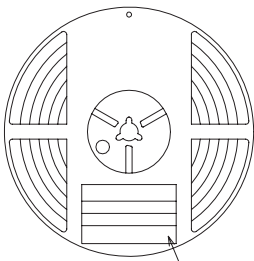

Reel label

Type No.
LOT No.
Quantity
Origin

Reel label, Inner box label (unit:mm)

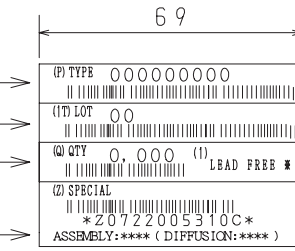

Outer box label

It is a label at the time of factory shipments. The form of a label may change in physical distribution process.

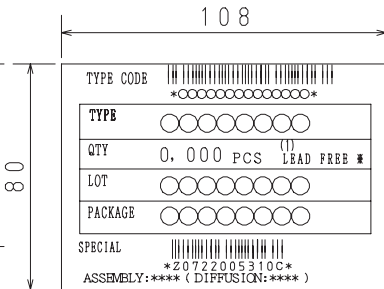

NOTE (1)

The LEAD FREE * description shows that the surface treatment of the terminal is lead free.

Label	JEITA Phase
LEAD FREE 3	JEITA Phase 3A
LEAD FREE 4	JEITA Phase 3

2. Taping configuration

2-1. Carrier tape size (unit:mm)

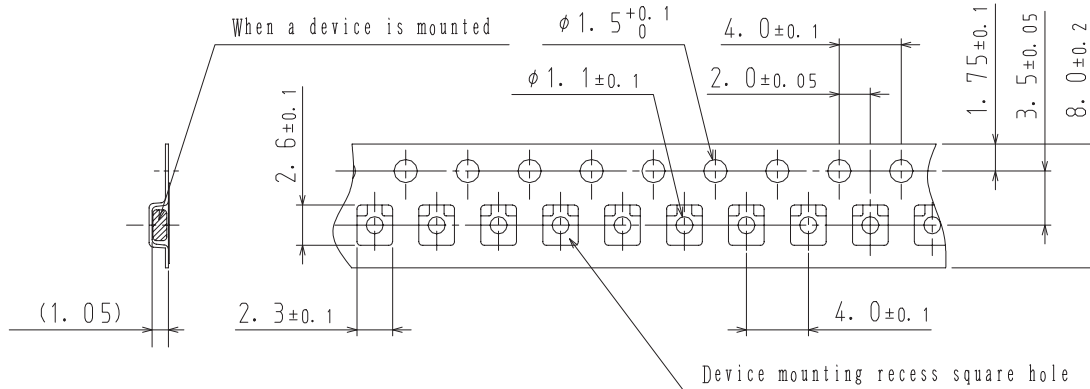

2-2. Device placement direction

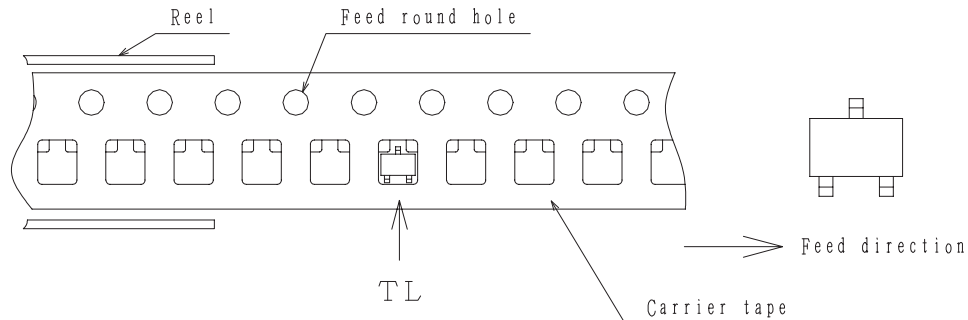

Those with oen electrode terminal on the feed hole side.....TL

2SC4853A

Outline Drawing 2SC4853A-4-TL-E

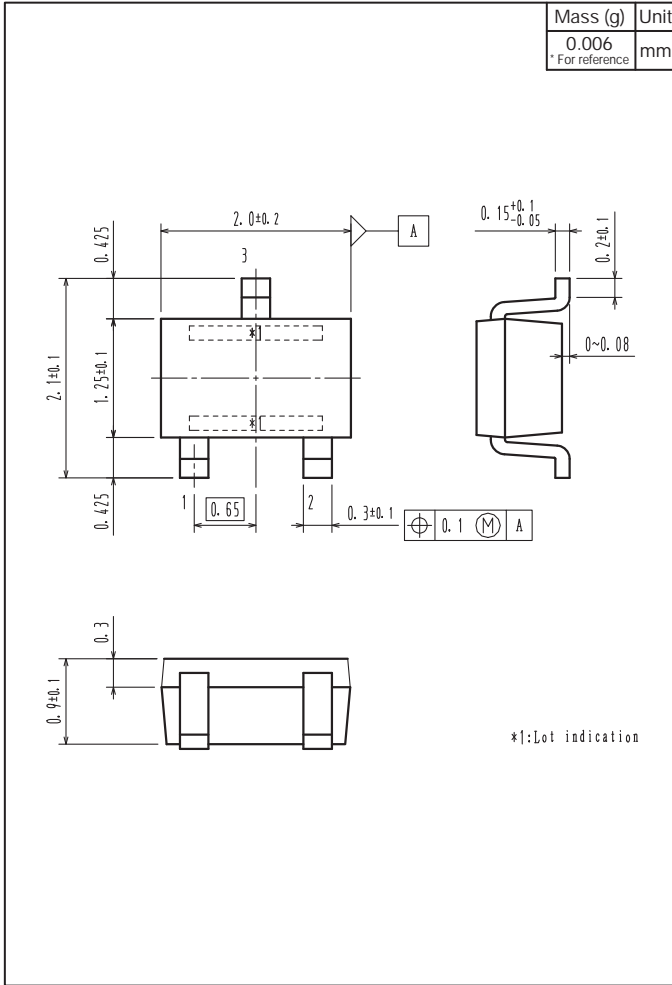

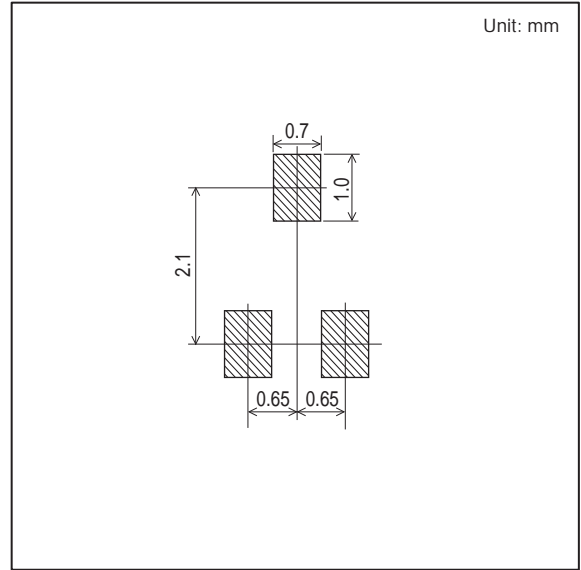

Land Pattern Example



ON Semiconductor and the ON logo are registered trademarks of Semiconductor Components Industries, LLC (SCILLC). SCILLC owns the rights to a number of patents, trademarks, copyrights, trade secrets, and other intellectual property. A listing of SCILLC's product/patent coverage may be accessed at www.onsemi.com/site/pdf/Patent-Marking.pdf. SCILLC reserves the right to make changes without further notice to any products herein. SCILLC makes no warranty, representation or guarantee regarding the suitability of its products for any particular purpose, nor does SCILLC assume any liability arising out of the application or use of any product or circuit, and specifically disclaims any and all liability, including without limitation special, consequential or incidental damages. "Typical" parameters which may be provided in SCILLC data sheets and/or specifications can and do vary in different applications and actual performance may vary over time. All operating parameters, including "Typicals" must be validated for each customer application by customer's technical experts. SCILLC does not convey any license under its patent rights nor the rights of others. SCILLC products are not designed, intended, or authorized for use as components in systems intended for surgical implant into the body, or other applications intended to support or sustain life, or for any other application in which the failure of the SCILLC product could create a situation where personal injury or death may occur. Should Buyer purchase or use SCILLC products for any such unintended or unauthorized application, Buyer shall indemnify and hold SCILLC and its officers, employees, subsidiaries, affiliates, and distributors harmless against all claims, costs, damages, and expenses, and reasonable attorney fees arising out of, directly or indirectly, any claim of personal injury or death associated with such unintended or unauthorized use, even if such claim alleges that SCILLC was negligent regarding the design or manufacture of the part. SCILLC is an Equal Opportunity/Affirmative Action Employer. This literature is subject to all applicable copyright laws and is not for resale in any manner.

Looking for pricing, stock, or lifecycle information?

Click below to explore more details on WIN SOURCE:

-  [View 2SC4853](#) on WIN SOURCE
-  [ON Semiconductor](#) Information

Optimize Your Supply Chain with WIN SOURCE Solutions

-  Global Sourcing Solution
-  Obsolete Management
-  Cost Control Management
-  Shortage Management
-  Alternative Solution
-  Excess Inventory Management