



**THE DATASHEET OF  
MAX4473EUA-T**





# Low-Cost, Low-Voltage, PA Power Control Amplifier for GSM Applications

## ABSOLUTE MAXIMUM RATINGS

V <sub>CC</sub> to GND.....	7V	Continuous Power Dissipation (T <sub>A</sub> = +70°C)	
SR1, SR2, SR3, PC, $\overline{\text{SHDN}}$ , OUT to GND .....	-0.3V to (V <sub>CC</sub> + 0.3V)	8-Pin $\mu$ MAX (derate 4.10mW/°C above +70°C) .....	330mW
SR1 to SR3.....	0 to V <sub>CC</sub>	8-Pin SO (derate 5.88mW/°C above +70°C).....	471mW
OUT and SR3 Short-Circuit Duration to V <sub>CC</sub> or GND .....	Continuous	Operating Temperature Range .....	-40°C to +85°C
Current into Any Pin.....	±50mA	Junction Temperature.....	+150°C
		Storage Temperature Range.....	-65°C to +150°C
		Lead Temperature (soldering, 10s) .....	+300°C

Stresses beyond those listed under "Absolute Maximum Ratings" may cause permanent damage to the device. These are stress ratings only, and functional operation of the device at these or any other conditions beyond those indicated in the operational sections of the specifications is not implied. Exposure to absolute maximum rating conditions for extended periods may affect device reliability.

## ELECTRICAL CHARACTERISTICS

(V<sub>CC</sub> = 2.7V to 6.5V,  $\overline{\text{SHDN}}$  > 2.4V, MAX4473 test circuit, R<sub>G1</sub> = R<sub>G2</sub> = 1k $\Omega$   $\pm$ 1%, R<sub>G3</sub> = 2.5k $\Omega$   $\pm$ 1%, R<sub>SENSE</sub> = 100 $\Omega$   $\pm$ 1%, R<sub>L</sub> = 10k $\Omega$ , C<sub>L</sub> = 300pF, T<sub>A</sub> = T<sub>MIN</sub> to T<sub>MAX</sub>, unless otherwise noted. Typical values are at V<sub>CC</sub> = 6.0V, V<sub>PC</sub> = 1.0V, T<sub>A</sub> = +25°C.) (Note 1)

PARAMETER	CONDITIONS	MIN	TYP	MAX	UNITS
<b>GENERAL</b>					
Supply Voltage		2.7		6.5	V
Supply Current	V <sub>PC</sub> = 0		1.2	2	mA
Shutdown Supply Current	$\overline{\text{SHDN}}$ < 0.4V, R <sub>L</sub> = 10 $\Omega$		0.03	1	$\mu$ A
$\overline{\text{SHDN}}$ Input High Voltage		2.4			V
$\overline{\text{SHDN}}$ Input Low Voltage				0.4	V
$\overline{\text{SHDN}}$ Input Current	$\overline{\text{SHDN}}$ = 0 to V <sub>CC</sub>			±0.5	$\mu$ A
<b>ERROR AMPLIFIER</b>					
SR1, SR2 Input Offset Voltage	1V < V <sub>SR1</sub> , V <sub>SR2</sub> < V <sub>CC</sub>		±0.5	±2	mV
	1V < V <sub>SR1</sub> , V <sub>SR2</sub> < V <sub>CC</sub> at +25°C		±0.5	±1	
SR1, SR2 Input Offset Voltage Drift	1V < V <sub>SR1</sub> , V <sub>SR2</sub> < V <sub>CC</sub>		10		$\mu$ V/°C
SR1, SR2 Input Common-Mode Voltage Range	Inferred from CMRR test; V <sub>SR2</sub> = GND (Note 2)	1		V <sub>CC</sub>	V
SR1, SR2 Input Bias Current	1V < V <sub>SR1</sub> , V <sub>SR2</sub> < V <sub>CC</sub> , V <sub>PC</sub> = GND, SR3 = unconnected		±0.04	±1	$\mu$ A
SR1, SR2 Input Bias Offset Current	1V < V <sub>SR1</sub> , V <sub>SR2</sub> < V <sub>CC</sub> , V <sub>PC</sub> = GND, SR3 = unconnected		±0.001	±0.2	$\mu$ A
SR1, SR2 Shutdown Leakage Current	$\overline{\text{SHDN}}$ < 0.4V, V <sub>SR1</sub> = V <sub>SR2</sub> = V <sub>CC</sub>		±0.001	±0.5	$\mu$ A
Common-Mode Rejection Ratio	1V < V <sub>SR1</sub> , V <sub>SR2</sub> < V <sub>CC</sub> , V <sub>PC</sub> = GND	V <sub>CC</sub> = 2.7V	65	85	dB
		V <sub>CC</sub> = 6.5V	75	95	
Power-Supply Rejection Ratio	2.7V < V <sub>CC</sub> < 6.5V, V <sub>PC</sub> = GND	80	90		dB
Large-Signal Gain	R <sub>L</sub> = 10k $\Omega$ to V <sub>CC</sub> / 2	V <sub>CC</sub> = 6.5V, 0.3V < V <sub>OUT</sub> < 6V	80	130	dB
		V <sub>CC</sub> = 2.7V, 0.3V < V <sub>OUT</sub> < 2.4V	80	125	
	R <sub>L</sub> = 500 $\Omega$ to V <sub>CC</sub> / 2	V <sub>CC</sub> = 6.5V, 0.7V < V <sub>OUT</sub> < 5.5V	80	130	
		V <sub>CC</sub> = 2.7V, 0.7V < V <sub>OUT</sub> < 2.2V	80	120	

# Low-Cost, Low-Voltage, PA Power Control Amplifier for GSM Applications

MAX4473

## ELECTRICAL CHARACTERISTICS (continued)

( $V_{CC} = 2.7V$  to  $6.5V$ ,  $\overline{SHDN} > 2.4V$ , MAX4473 test circuit,  $RG1 = RG2 = 1k\Omega \pm 1\%$ ,  $RG3 = 2.5k\Omega \pm 1\%$ ,  $R_{SENSE} = 100\Omega \pm 1\%$ ,  $R_L = 10k\Omega$ ,  $C_L = 300pF$ ,  $T_A = T_{MIN}$  to  $T_{MAX}$ , unless otherwise noted. Typical values are at  $V_{CC} = 6.0V$ ,  $V_{PC} = 1.0V$ ,  $T_A = +25^\circ C$ .) (Note 1)

PARAMETER	CONDITIONS	MIN	TYP	MAX	UNITS
Output Voltage Swing	$R_L = 10\Omega$ to $V_{CC} / 2$	0.15		$V_{CC} - 0.15$	V
	$R_L = 500\Omega$ to $V_{CC} / 2$	0.5		$V_{CC} - 0.5$	
Output Current Limit	$V_{OUT} = V_{CC} / 2$		20		mA
Gain-Bandwidth Product	$R_L = 10\Omega$ , $C_L = 300pF$ , $f_o = 10kHz$		2		MHz
Phase Margin	$R_L = 10\Omega$ , $C_L = 300pF$		60		degrees
Slew Rate	Measured from 30% to 70% of $V_{OUT}$ , $R_L = 10\Omega$ , $C_L = 300pF$		1.8		V/ $\mu s$
Capacitive-Load Stability	No sustained oscillations (Note 3)	0		300	pF
Enable/Disable Time	From 50% of $\overline{SHDN}$ edge to $V_{OUT} = 1V$ , $V_{PC} = 2V$		0.9	1.5	$\mu s$
<b>GAIN CONTROL BUFFER AND V-TO-I CONVERTER</b>					
PC Input Bias Current	$GND < V_{PC} < V_{CC} - 0.15V$		$\pm 0.04$	$\pm 1$	$\mu A$
SR3 Output Current Limit	$V_{PC} < 2.55V$ , $SR1 = SR2 = V_{CC}$	0.750	4		mA
$V_{PC}$ to $VRG1$ Ratio	Measure voltage across $RG1$ , $0.3V < V_{PC} < 2.55V$ (Note 4)	0.095	0.1	0.105	V/V
PC Input Bandwidth	Bandwidth from $V_{PC}$ to $VRG1$		2		MHz

**Note 1:** Limits over temperature are guaranteed by design.

**Note 2:** No output phase-reversal for input common-mode voltage range from GND to  $V_{CC}$ . Common-mode range limited by voltage drop across Q1 and  $RG3$ .

**Note 3:** Guaranteed by design.

**Note 4:** Error dependent on tolerance of  $RG1$ ,  $RG2$ , and  $RG3$ . Specified with 0.1% tolerance resistors.

# Low-Cost, Low-Voltage, PA Power Control Amplifier for GSM Applications

## Typical Operating Characteristics

(See Test Circuit,  $T_A = +25^\circ\text{C}$ , unless otherwise noted.)

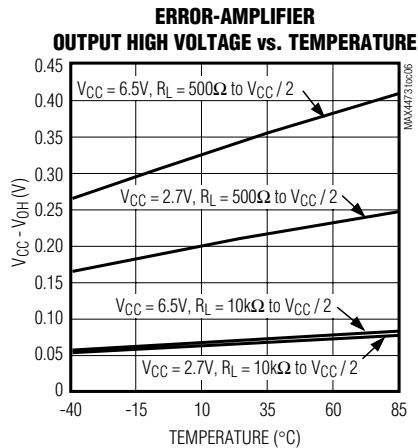
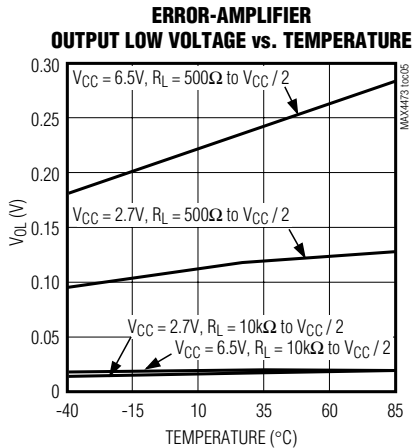
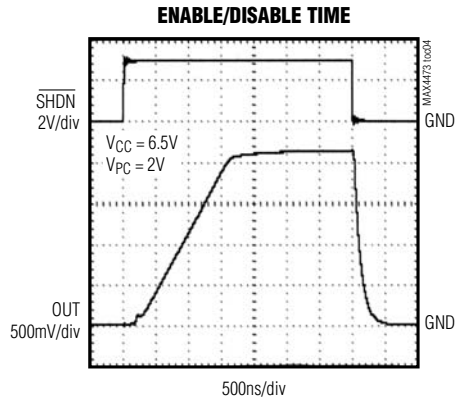
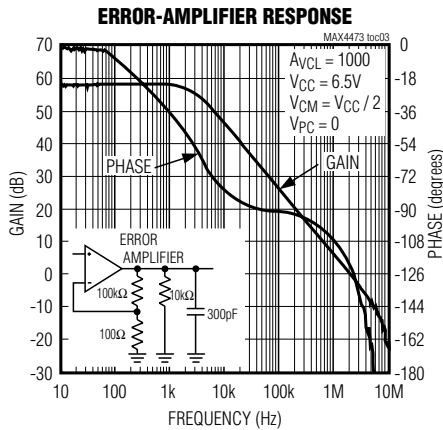
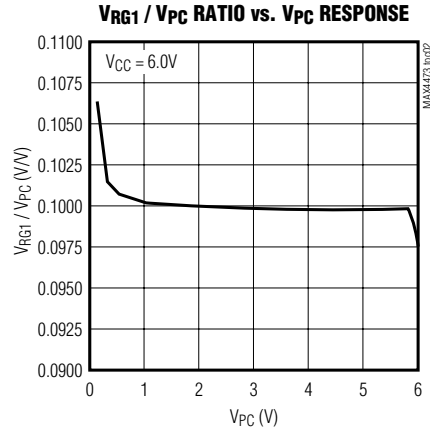
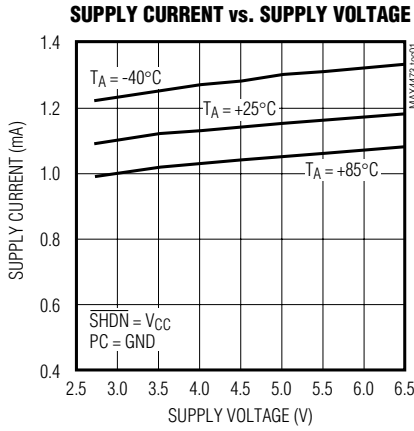

# Low-Cost, Low-Voltage, PA Power Control Amplifier for GSM Applications

## Pin Description

MAX4473

PIN	NAME	FUNCTION
1	SR1	Inverting Input of Error Amplifier and Drain of V-to-I FET, Q1. Connect to supply side of current-sense resistor, R <sub>SENSE</sub> , through gain resistor RG1.
2	SR2	Noninverting Input of Error Amplifier. Connect to load side of current-sense resistor, R <sub>SENSE</sub> , through gain resistor RG2. Set RG2 equal to RG1.
3	$\overline{\text{SHDN}}$	Shutdown Input. Drive $\overline{\text{SHDN}}$ low to disable all amplifiers, pull OUT to GND, set the gate-to-source voltage of the V-to-I FET (Q1) to 0, and reduce supply current to less than 1 $\mu$ A. Drive high or connect to V <sub>CC</sub> for normal operation.
4	PC	Power Control Input. Apply a voltage to PC to set a DC current through the sense resistor to control PA bias.
5	GND	Ground
6	SR3	Inverting Input to V-to-I Converter and Source of V-to-I FET, Q1. Connect to ground through gain resistor RG3.
7	OUT	Output of Error Amplifier. Connect to gain control pin of power amplifier in bias control applications.
8	VCC	+2.7V to +6.5V Voltage Supply Input. Bypass to ground with a 0.1 $\mu$ F capacitor.

## Detailed Description

The MAX4473 is a voltage-controlled, unidirectional, high-side current setting amplifier for applications where accurate control of PA supply current is desired. This device is intended for wireless TDMA based systems (GSM, DECT), where tight restrictions over the PA's transmit burst and output power require closed-loop control over the PA's output power. When used with a PA, the MAX4473 functions as a voltage-controlled constant current source, accurately setting PA supply current by varying the gain of the PA. If you know the output power versus supply current profile for the PA, you can set the PA's output power by controlling the amount of supply current delivered to the PA.

The MAX4473 is composed of an input buffer (A1), a voltage-to-current converting amplifier (A2), and a rail-to-rail output error amplifier (A3) (see *Typical Operating Circuit*). External gain and sense resistors allow programmability for a wide range of applications.

In the *Typical Operating Circuit*, PA supply current flows from the system supply, through the external current-sense resistor (R<sub>SENSE</sub>), to the PA. The rail-to-rail outputs of the error amplifier, A3, adjust the gain of the

PA until the voltage drop across R<sub>SENSE</sub> equals the voltage drop across external gain resistor, RG1. The voltage drop across RG1 sets the voltage drop across R<sub>SENSE</sub>, with a larger voltage drop resulting in more current delivered to the PA. The voltage drop across RG1 is set by A1, A2, and the V-to-I FET, Q1. A voltage applied to the PC input of the input buffer is divided by four by a resistor-divider network. A2 forces its inverting input and the source of Q1 to V<sub>PC</sub> / 4, thus setting a voltage across RG3. The resulting current through RG3 sets the current through RG1. This unique architecture allows the supply current to be set independent of supply voltage. Set PA supply current according to the following equation:

$$I_{CCPA} = (V_{PC} \cdot RG1) / (4 \cdot R_{SENSE} \cdot RG3)$$

## Shutdown Mode

When  $\overline{\text{SHDN}}$  is a logic-level low ( $\overline{\text{SHDN}} < 0.4\text{V}$ ), amplifiers A1, A2, and A3 are off, Q1 is turned off, and the output of A3 is actively pulled to ground with an N-channel FET. Supply current is reduced to less than 1 $\mu$ A in shutdown mode. Typical power-up time is 0.9 $\mu$ s and typical power-down time is 0.3 $\mu$ s, using the MAX4473 test circuit.

# Low-Cost, Low-Voltage, PA Power Control Amplifier for GSM Applications

## Applications Information

### Gain Resistor Selection (RG1, RG2, RG3)

For proper operation, do not make the value of external gain resistors RG1 and RG2 larger than twice the value of RG3. In most practical applications, choose RG1 smaller than RG3 to limit the voltage drop over RG1 and RSENSE. A large voltage drop over RSENSE substantially reduces the voltage applied to the PA, thus reducing PA output power. Set RG2 equal to RG1 to compensate for the input bias currents of A3. Recommended values for RG3 are between 1k $\Omega$  and 10k $\Omega$ .

### Sense Resistor Selection (RSENSE)

Choose RSENSE based on the following criteria:

- **Voltage Loss:** A high RSENSE value causes the power-source voltage to degrade through IR loss. For minimal voltage loss, use low RSENSE values.

- **Accuracy:** A high RSENSE value allows lower currents to be measured more accurately because input offset voltages become less significant when the sense voltage is larger. For best performance, select RSENSE to provide approximately 100mV of sense voltage for the full-scale current in each application.
- **Efficiency and Power Dissipation:** At high current levels, the I<sup>2</sup>R losses in RSENSE are significant. Take this into consideration when choosing the resistor value and its power dissipation (wattage) rating. Also, the sense resistor's value may drift if it is allowed to heat up excessively.

## Test Circuit

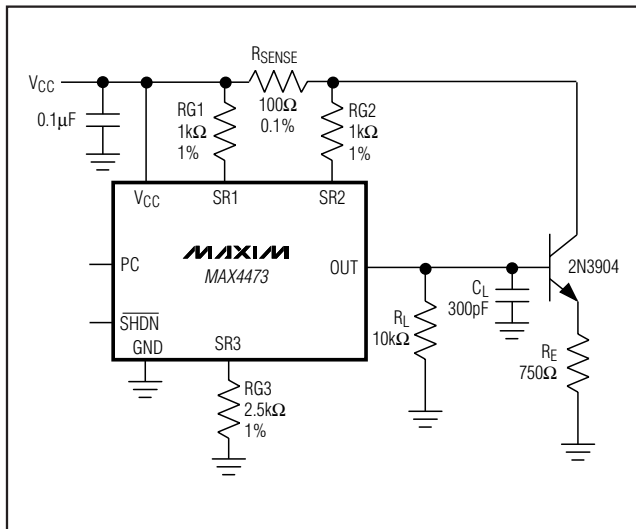

## Pin Configuration

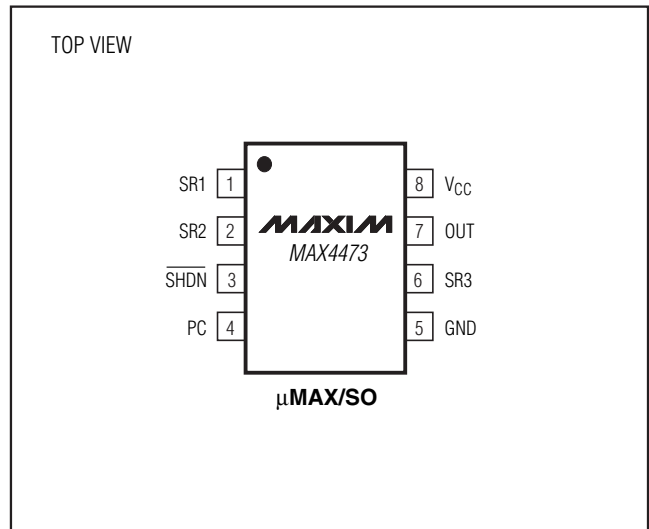

## Chip Information

TRANSISTOR COUNT: 348

# Low-Cost, Low-Voltage, PA Power Control Amplifier for GSM Applications

## Package Information

For the latest package outline information and land patterns, go to [www.maxim-ic.com/packages](http://www.maxim-ic.com/packages).

PACKAGE TYPE	PACKAGE CODE	DOCUMENT NO.
8 $\mu$ MAX	U8-1	<a href="#">21-0036</a>
8 SO	S8-2	<a href="#">21-0041</a>

MAX4473

DIM	INCHES		MILLIMETERS	
	MIN	MAX	MIN	MAX
A	—	0.043	—	1.10
A1	0.002	0.006	0.05	0.15
A2	0.030	0.037	0.75	0.95
b	0.010	0.014	0.25	0.36
c	0.005	0.007	0.13	0.18
D	0.116	0.120	2.95	3.05
e	0.0256 BSC		0.65 BSC	
E	0.116	0.120	2.95	3.05
H	0.188	0.198	4.78	5.03
L	0.016	0.026	0.41	0.66
$\alpha$	0°	6°	0°	6°
S	0.0207 BSC		0.5250 BSC	

PKG. CODES:  
U8-1; U8-3; U8C-3; U8CN-1

NOTES:

1. D&E DO NOT INCLUDE MOLD FLASH.
2. MOLD FLASH OR PROTRUSIONS NOT TO EXCEED 0.15MM (.006").
3. CONTROLLING DIMENSION: MILLIMETERS.
4. COMPLIES TO JEDEC MO-187, LATEST REVISION, VARIATION AA.
5. MARKING SHOWN IS FOR PKG. ORIENTATION ONLY.
6. ALL DIMENSIONS APPLY TO BOTH LEADED (-) AND PbFREE (+) PKG. CODES.

—DRAWING NOT TO SCALE—

TITLE:  
PACKAGE OUTLINE, 8L  $\mu$ MAX/ $\mu$ SOP

APPROVAL	DOCUMENT CONTROL NO. 21-0036	REV. K 1/1
----------	---------------------------------	------------

8LUMAXD.EPS

# Low-Cost, Low-Voltage, PA Power Control Amplifier for GSM Applications

## Package Information (continued)

For the latest package outline information and land patterns, go to [www.maxim-ic.com/packages](http://www.maxim-ic.com/packages).

SOICN .150

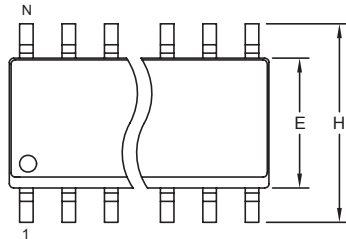

TOP VIEW

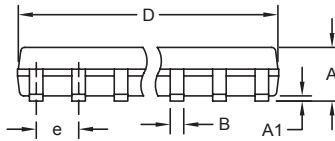

FRONT VIEW

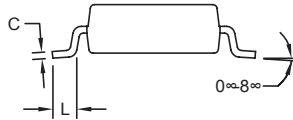

SIDE VIEW

DIM	INCHES		MILLIMETERS	
	MIN	MAX	MIN	MAX
A	0.053	0.069	1.35	1.75
A1	0.004	0.010	0.10	0.25
B	0.014	0.019	0.35	0.49
C	0.007	0.010	0.19	0.25
e	0.050 BSC		1.27 BSC	
E	0.150	0.157	3.80	4.00
H	0.228	0.244	5.80	6.20
L	0.016	0.050	0.40	1.27

VARIATIONS:

DIM	INCHES		MILLIMETERS		N	MS012
	MIN	MAX	MIN	MAX		
D	0.189	0.197	4.80	5.00	8	AA
D	0.337	0.344	8.55	8.75	14	AB
D	0.386	0.394	9.80	10.00	16	AC

NOTES:

1. D&E DO NOT INCLUDE MOLD FLASH.
2. MOLD FLASH OR PROTRUSIONS NOT TO EXCEED 0.15mm (.006").
3. LEADS TO BE COPLANAR WITHIN 0.10mm (.004").
4. CONTROLLING DIMENSION: MILLIMETERS.
5. MEETS JEDEC MS012.
6. N = NUMBER OF PINS.

<small>PROPRIETARY INFORMATION</small>	
TITLE: <b>PACKAGE OUTLINE, .150" SOIC</b>	
APPROVAL	DOCUMENT CONTROL NO. 21-0041
REV. B	1/1

# Low-Cost, Low-Voltage, PA Power Control Amplifier for GSM Applications

## Revision History

REVISION NUMBER	REVISION DATE	DESCRIPTION	PAGES CHANGED
4	11/08	Removed QFN package	1-9

**MAX4473**

Maxim cannot assume responsibility for use of any circuitry other than circuitry entirely embodied in a Maxim product. No circuit patent licenses are implied. Maxim reserves the right to change the circuitry and specifications without notice at any time.

**Maxim Integrated Products, 120 San Gabriel Drive, Sunnyvale, CA 94086 408-737-7600** \_\_\_\_\_ **9**

## Looking for pricing, stock, or lifecycle information?

Click below to explore more details on WIN SOURCE:

 [View MAX4473EUA-T on WIN SOURCE](#)

 [Analog Devices Inc. Information](#)

## Optimize Your Supply Chain with WIN SOURCE Solutions

-  Global Sourcing Solution
-  Obsolete Management
-  Cost Control Management
-  Shortage Management
-  Alternative Solution
-  Excess Inventory Management