



# THE DATASHEET OF MAX5005BCUB+T





# 150mA USB LDO Regulators with $\pm 15kV$ TVS and $\mu P$ Reset

## ABSOLUTE MAXIMUM RATINGS

IN to GND .....	-0.3V to +6V	Short-Circuit Duration .....	Indefinite
D+, D- to GND .....	-0.3V to +6V	Continuous Power Dissipation ( $T_A = +70^\circ C$ ) .....	
MR to GND .....	-0.3V to ( $V_{OUT} + 0.3V$ )	10-Pin $\mu$ MAX (derate 5.6mW/ $^\circ C$ above $+70^\circ C$ ) .....	444mW
RESET, RESET to GND, Push-Pull .....	-0.3V to ( $V_{OUT} + 0.3V$ )	Thermal Resistance ( $\theta_{JA}$ ) .....	180 $^\circ C/W$
RESET to GND, Open-Drain .....	-0.3V to +6V	Operating Temperature Range .....	0 $^\circ C$ to $+70^\circ C$
OUT, SELR, ENR to GND .....	-0.3V to +6V	Junction Temperature .....	$+150^\circ C$
Maximum Current to Any Pin (except IN, OUT, D+, D-) .....	$\pm 20mA$	Storage Temperature Range .....	$-65^\circ C$ to $+150^\circ C$
		Lead Temperature (soldering, 10s) .....	$+300^\circ C$

Stresses beyond those listed under "Absolute Maximum Ratings" may cause permanent damage to the device. These are stress ratings only, and functional operation of the device at these or any other conditions beyond those indicated in the operational sections of the specifications is not implied. Exposure to absolute maximum rating conditions for extended periods may affect device reliability.

## ELECTRICAL CHARACTERISTICS

( $V_{IN} = +5V$ ,  $I_{OUT} = 0$ ,  $C_{OUT} = 2.2\mu F$ ,  $T_A = 0^\circ C$  to  $+70^\circ C$ , unless otherwise noted. Typical specifications are at  $T_A = +25^\circ C$ .) (Note 1)

PARAMETER	SYMBOL	CONDITIONS	MIN	TYP	MAX	UNITS
Input Voltage Range	$V_{IN}$	$I_{LOAD} = 100mA$	4.0		5.5	V
Supply Current	$I_{GND}$	Measured at GND		25	50	$\mu A$
<b>REGULATOR</b>						
Guaranteed Output Current	$I_{OUT}$		150			mA
Output Voltage	$V_{OUT}$	$V_{IN} = 4.0V$ to $5.5V$ , $I_{OUT} = 0$ to $100mA$	3.2	3.3	3.4	V
Dropout Voltage (Note 2)	$\Delta V_{DO}$	$I_{LOAD} = 10mA$		20	30	mV
		$I_{LOAD} = 150mA$		300	400	
Output Current Limit		$V_{IN} = 5.5V$	165	350		mA
Input Reverse Leakage Current		$V_{IN} = 0$ , $V_{OUT} = 5.5V$		1		$\mu A$
Startup Response Time		Rising edge of $V_{IN}$ to $V_{OUT}$ $R_L = 500\Omega$		500		$\mu s$
Thermal Shutdown Temperature	$T_{JSHDN}$			160		$^\circ C$
Thermal Shutdown Hysteresis	$\Delta T_{JSHDN}$			20		$^\circ C$
<b>RESET CIRCUIT</b>						
Reset Threshold (Note 3)	$V_{TH}$	MAX500_ACUB	2.92	3.05	3.18	V
		MAX500_BCUB	2.75	2.89	3.01	
Reset Timeout Period	$t_{RP}$		100	200	300	ms
$V_{OUT}$ to Reset Delay	$t_{RD}$			75		$\mu s$
$\overline{MR}$ Input Voltage	$V_{IL}$				$0.2 \times V_{OUT}$	V
	$V_{IH}$		$0.8 \times V_{OUT}$			
$\overline{MR}$ Minimum Input Pulse Width			1			$\mu s$
$\overline{MR}$ Glitch Rejection				120		ns
$\overline{MR}$ to Reset Delay				500		ns
$\overline{MR}$ Pullup Resistance to OUT			10	25	45	k $\Omega$
SELR Input Voltage	$V_{IL}$	Connects $R_{TERM}$ to D-			$0.2 \times V_{OUT}$	V
	$V_{IH}$	Connects $R_{TERM}$ to D+	$0.8 \times V_{OUT}$			

# 150mA USB LDO Regulators with $\pm 15\text{kV}$ TVS and $\mu\text{P}$ Reset

MAX5005/MAX5006/MAX5007

## ELECTRICAL CHARACTERISTICS (continued)

( $V_{IN} = +5\text{V}$ ,  $I_{OUT} = 0$ ,  $C_{OUT} = 2.2\mu\text{F}$ ,  $T_A = 0^\circ\text{C}$  to  $+70^\circ\text{C}$ , unless otherwise noted. Typical specifications are at  $T_A = +25^\circ\text{C}$ .) (Note 1)

PARAMETER	SYMBOL	CONDITIONS	MIN	TYP	MAX	UNITS
SELR Input Current		SELR = GND or OUT	-1		1	$\mu\text{A}$
$\overline{\text{ENR}}$ Input Voltage	$V_{IL}$	RTERM enabled			$0.2 \times V_{OUT}$	V
	$V_{IH}$	RTERM disabled	$0.8 \times V_{OUT}$			
$\overline{\text{ENR}}$ Input Current		$\overline{\text{ENR}}$ = GND or OUT	-1		1	$\mu\text{A}$
Open-Drain $\overline{\text{RESET}}$ Output Low Voltage (MAX5005)	$V_{OL}$	$V_{OUT} \geq 1.0\text{V}$ , $I_{SINK} = 50\mu\text{A}$ , reset asserted			0.3	V
		$V_{OUT} \geq 2.7\text{V}$ , $I_{SINK} = 3.2\text{mA}$ , reset asserted			0.4	
Open-Drain Reset Output Leakage Current (MAX5005)	$I_{LKG}$	Reset not asserted	-1.0		1.0	$\mu\text{A}$
Push-Pull $\overline{\text{RESET}}$ Output Voltage (MAX5006)	$V_{OL}$	$V_{OUT} = 1.0\text{V}$ , $I_{SINK} = 50\mu\text{A}$ , reset asserted			0.3	V
		$V_{OUT} > V_{TH(MIN)}$ , $I_{SINK} = 3.2\text{mA}$ , reset asserted			0.4	
	$V_{OH}$	$V_{OUT} > V_{TH(MAX)}$ , $I_{SOURCE} = 500\mu\text{A}$ , reset not asserted	$0.8 \times V_{OUT}$			
Push-Pull RESET Output Voltage (MAX5007)	$V_{OL}$	$V_{OUT} > V_{TH(MAX)}$ , $I_{SINK} = 3.2\text{mA}$ , reset not asserted			0.4	V
	$V_{OH}$	$V_{OUT} = 1.0\text{V}$ , $I_{SOURCE} = 150\mu\text{A}$ , reset asserted	$0.8 \times V_{OUT}$			
<b>USB OPTIONS AND TRANSIENT SUPPRESSION</b>						
D+/D- RTERM Impedance		$\overline{\text{ENR}}$ = GND, SELR = GND or OUT	1425	1500	1575	$\Omega$
D+/D- Input Leakage Current		$V_{\overline{\text{ENR}}} = V_{OUT} = 3.3\text{V}$	-1		1	$\mu\text{A}$
D+ to D- Capacitance		1MHz, 100mVp-p signal applied at D+ and D-, $V_{OUT} = 3.3\text{V}$	$\overline{\text{ENR}}$ = OUT		5.5	$\mu\text{F}$
			Unpowered		24	
D+, D- Capacitance to GND		1MHz, 100mVp-p signal applied at D+ and D-, $V_{OUT} = 3.3\text{V}$	$\overline{\text{ENR}}$ = OUT		40	$\mu\text{F}$
			Unpowered		47	
ESD Trigger Voltage		$dV/dt \leq 1\text{V/ns}$ , $V_{D+}$ or $V_{D-} > 3.6\text{V}$	3.6	5		V
Surge Trigger Voltage		$dV/dt \leq 2\text{V}/\mu\text{s}$ , $V_{D+}$ or $V_{D-} > 3.6\text{V}$	3.6	16		V
Clamping Voltage		6A, pulse width = 200ns to 40 $\mu\text{s}$		16		V
Surge Current		16V, pulse width = 200ns to 40 $\mu\text{s}$		$\pm 6$		A
D+/D- to GND ESD		Human Body Model MIL-STD-883		$\pm 16$		kV
		Contact Discharge IEC1000-4-2 (EN61000-4-2)		$\pm 8$		
		Air Discharge IEC1000-4-2 (EN61000-4-2)		$\pm 15$		

**Note 1:** All devices are 100% tested at  $T_A = +25^\circ\text{C}$ . Limits over temperature are guaranteed by characterization and not production tested.

**Note 2:** Dropout voltage is defined as  $V_{IN} - V_{OUT}$  when  $V_{OUT}$  is 2% below the value of  $V_{OUT}$  for  $V_{IN} = V_{OUT} + 1\text{V}$ .

**Note 3:** Specification is guaranteed to  $\pm 4\sigma$  limit.

# 150mA USB LDO Regulators with ±15kV TVS and μP Reset

## Typical Operating Characteristics

( $V_{IN} = +5V$ ,  $I_{OUT} = 0$ ,  $C_{OUT} = 2.2\mu F$ , unless otherwise noted.)

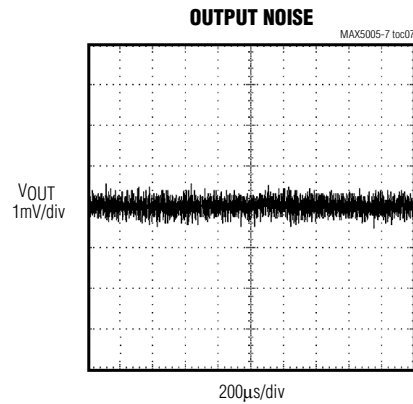
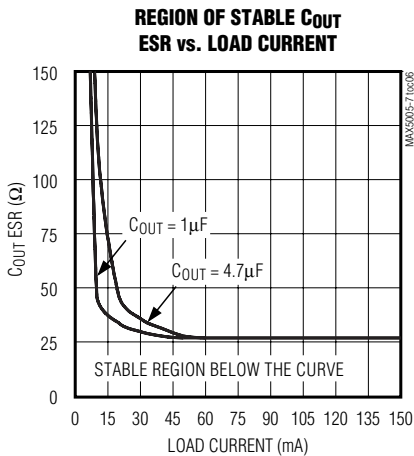
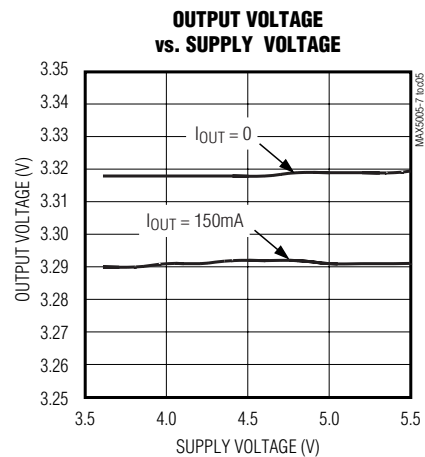
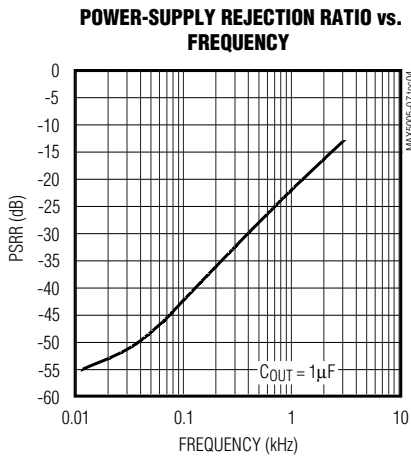
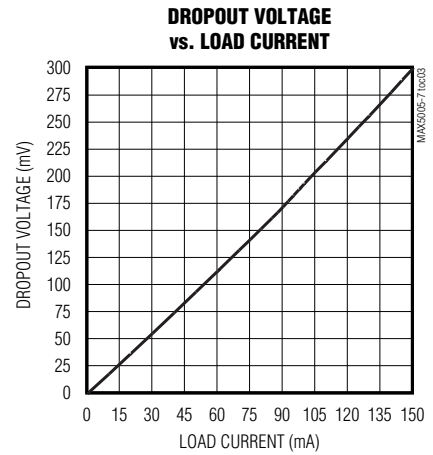
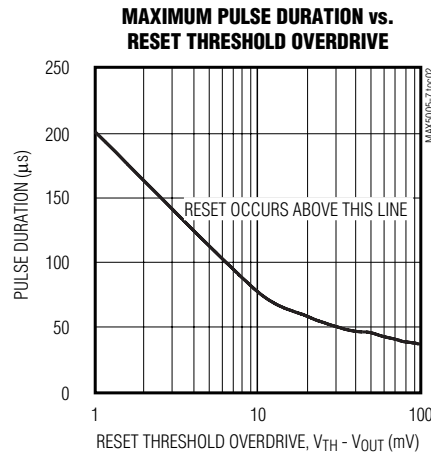
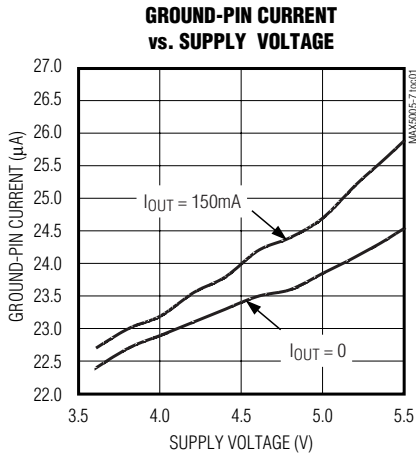

# 150mA USB LDO Regulators with $\pm 15kV$ TVS and $\mu P$ Reset

## Typical Operating Characteristics (continued)

( $V_{IN} = +5V$ ,  $I_{OUT} = 0$ ,  $C_{OUT} = 2.2\mu F$ , unless otherwise noted.)

MAX5005/MAX5006/MAX5007

**TURN-ON/TURN-OFF RESPONSE**

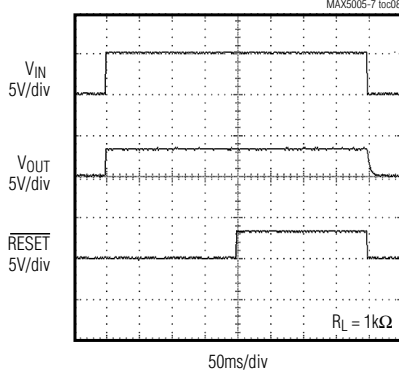

**STARTUP RESPONSE**

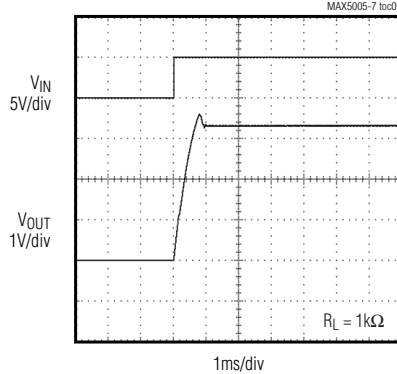

**LOAD-TRANSIENT RESPONSE**

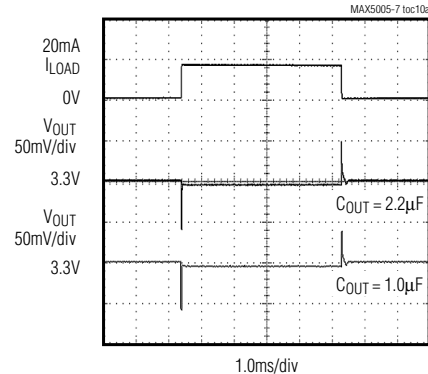

**LOAD-TRANSIENT RESPONSE**

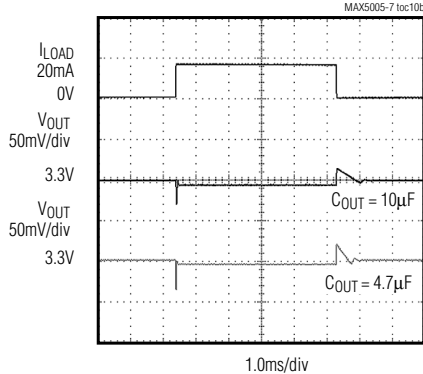

**LINE-TRANSIENT RESPONSE**

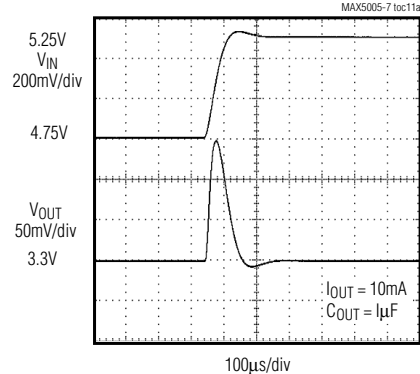

**LINE-TRANSIENT RESPONSE**

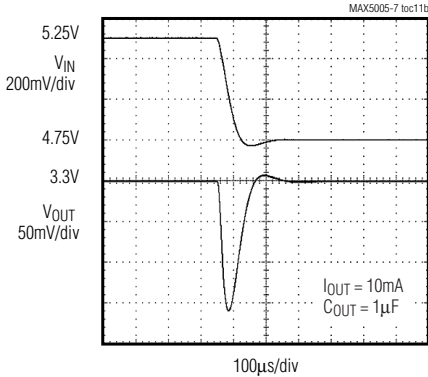

**TVS PEAK POWER vs. PULSE WIDTH**

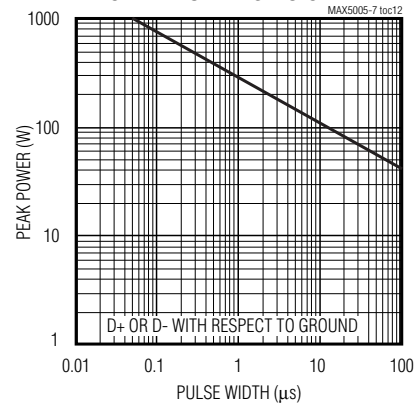

# 150mA USB LDO Regulators with $\pm 15\text{kV}$ TVS and $\mu\text{P}$ Reset

## Pin Description

PIN	NAME	DESCRIPTION
1	IN	Regulator Input. Supply voltage ranges from +4.0V to +5.5V. Bypass with a 1 $\mu\text{F}$ ceramic capacitor to ground.
2	D+	D+ ESD/Transient Suppression Input. Connect directly to USB port D+ data input. SELR high and $\overline{\text{ENR}}$ low connects D+ to OUT through a 1.5k $\Omega$ resistor.
3, 9	GND	Ground. This pin also functions as a heatsink. Solder to large pads or the circuit board ground plane to maximize thermal dissipation.
4	D-	D- ESD/Transient Suppression Input. Connect directly to USB port D- data input. SELR low and $\overline{\text{ENR}}$ low connects D- to OUT through a 1.5k $\Omega$ resistor.
5	SELR	USB Full-Speed/Low-Speed Termination Resistor Select. Logic high connects the termination resistor to D+ for full-speed peripherals. Logic low connects the termination resistor to D- for low-speed peripherals. An internal 1.5k $\Omega$ resistor connects to OUT when $\overline{\text{ENR}}$ is low.
6	$\overline{\text{ENR}}$	USB Termination Resistor Enable. When reset is not asserted, $\overline{\text{ENR}}$ low enables the termination resistor connection. $\overline{\text{ENR}}$ high or a reset disables the termination resistor connection.
7	$\overline{\text{RESET}}$	Active-Low Reset Output. $\overline{\text{RESET}}$ remains low while $V_{\text{OUT}}$ is below the reset threshold or while $\overline{\text{MR}}$ is held low. $\overline{\text{RESET}}$ remains low for the duration of the reset timeout period after the reset conditions are terminated. <b>(MAX5005/MAX5006 ONLY)</b>
	RESET	Active-High Reset Output. RESET remains high while $V_{\text{OUT}}$ is below the reset threshold or while $\overline{\text{MR}}$ is held low. RESET remains high for the duration of the reset timeout period after the reset conditions are terminated. <b>(MAX5007 ONLY)</b>
8	$\overline{\text{MR}}$	Active-Low Manual Reset Input. A logic low forces a reset. Reset remains asserted for the duration of the reset timeout period after $\overline{\text{MR}}$ transitions from low to high. Leave unconnected or connect to OUT if not used. $\overline{\text{MR}}$ has an internal pullup resistor of 25k $\Omega$ to OUT.
10	OUT	Voltage Regulator Output. Fixed +3.3V. Sources up to 150mA. Bypass with a 1 $\mu\text{F}$ (min) capacitor for full rated performance.

# 150mA USB LDO Regulators with $\pm 15\text{kV}$ TVS and $\mu\text{P}$ Reset

MAX5005/MAX5006/MAX5007

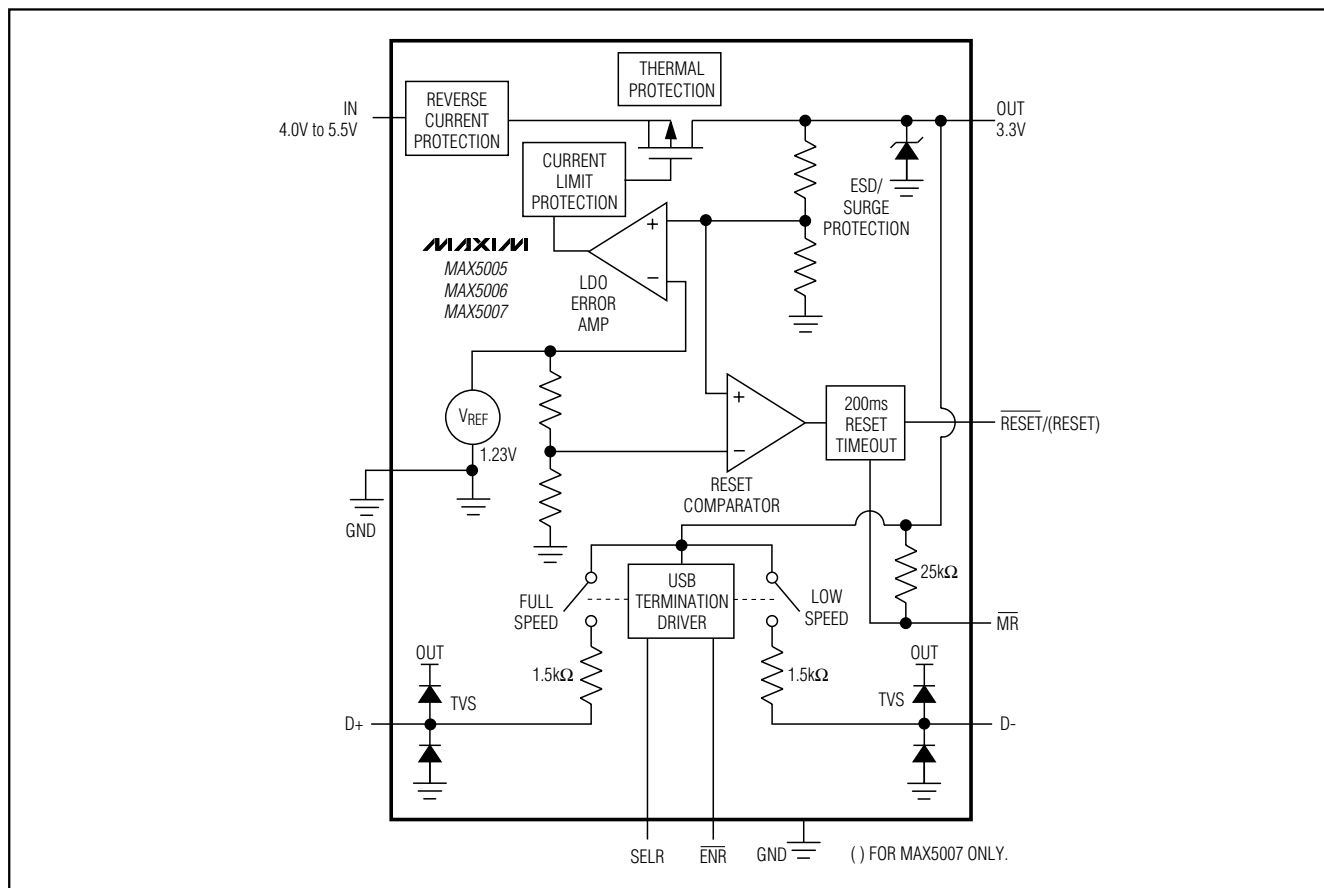

Figure 1. Functional Diagram

## Detailed Description

The MAX5005/MAX5006/MAX5007 are USB application-specific, low-dropout, low-quiescent current linear regulators with an integrated  $\mu\text{P}$  reset circuit (see Figure 1). The devices drive loads up to 150mA and are available with a fixed output voltage of +3.3V. Features include 1.5k $\Omega$  D+ and D- termination resistors and  $\pm 15\text{kV}$  transient voltage suppression (TVS) in accordance with IEC1000-4-2 (EN61000-4-2) Air Discharge Method and MILSTD883C- Method 3015-6 making the MAX5005/MAX5006/MAX5007 ideal for use with USB peripheral devices. The internal reset circuit monitors the regulator output voltage and asserts a reset signal when the output is typically -7.5% out of regulation for MAX500\_ACUB and -12.5% out of regulation for MAX500\_BCUB.

## Reset Circuit

The reset supervisor circuit is fully integrated in the MAX5005/MAX5006/MAX5007, and uses the same reference voltage as the regulator. Two supply tolerance reset thresholds, typically -7.5% and -12.5%, are available for each type of device.

**7.5% reset:** Reset does not assert until the regulator output voltage is at least -3.6% out of tolerance and always asserts before the regulator output voltage is -11.5% out of tolerance.

**12.5% reset:** Reset does not assert until the regulator output voltage is at least -8.8% out of tolerance and always asserts before the regulator output voltage is -16.7% out of tolerance.

## Reset Output

The MAX5005/MAX5006/MAX5007  $\mu\text{P}$  supervisory circuits assert a reset during power-up, power-down, and

# 150mA USB LDO Regulators with $\pm 15\text{kV}$ TVS and $\mu\text{P}$ Reset

brownout conditions. Reset is guaranteed to be logic high or low depending on the device chosen (see *Ordering Information*). RESET or  $\overline{\text{RESET}}$  asserts when  $V_{\text{OUT}}$  is below the reset threshold and remains asserted for at least 100ms minimum after  $V_{\text{OUT}}$  rises above the reset threshold.  $\overline{\text{RESET}}$  also asserts when  $\overline{\text{MR}}$  is pulled low.

## SELR and $\overline{\text{ENR}}$

When reset is not asserted a logic high to SELR connects a  $1.5\text{k}\Omega$  termination resistor from D+ to OUT for full speed USB peripherals and a logic low connects a  $1.5\text{k}\Omega$  termination resistor from D- to OUT for low-speed peripherals. Logic low on  $\overline{\text{ENR}}$  enables the selected termination resistor connection and logic high disables the selected termination resistor connection. An asserted reset always disconnects the termination resistors.

## D+ and D-

D+ and D- include transient voltage suppressors rated at  $\pm 15\text{kV}$  (see *USB  $\pm 15\text{kV}$  Transient Voltage Suppression* section).

The proprietary TVS shunt circuit passes no data through the MAX5005/MAX5006/MAX5007, thereby eliminating delays associated with series protection circuits. D+ and D- have only  $1\mu\text{A}$  of leakage current and a typical input capacitance of  $40\text{pF}$  at  $1\text{MHz}$ .

## Manual Reset Input

Many  $\mu\text{P}$ -based products require manual reset capability, allowing the operator, a test technician, or external logic circuitry to initiate a reset. A logic low on  $\overline{\text{MR}}$  asserts a reset while the regulator output voltage is still within tolerance.

Reset remains asserted while  $\overline{\text{MR}}$  is low and for the reset timeout period (100ms minimum) after  $\overline{\text{MR}}$  returns high. The  $\overline{\text{MR}}$  input has an internal pullup of  $25\text{k}\Omega$  (typ) to OUT. Drive this input with TTL/CMOS logic levels or with open-drain/collector outputs. Connect a normally open momentary switch from  $\overline{\text{MR}}$  to GND to create a manual reset function; external debounce circuitry is not required. If  $\overline{\text{MR}}$  is driven from long cables or the device is used in a noisy environment, connect a  $0.1\mu\text{F}$  capacitor from  $\overline{\text{MR}}$  to GND to provide additional noise immunity. For proper operation, ensure that the voltage on  $\overline{\text{MR}}$  is not greater than a diode drop above  $V_{\text{OUT}}$ .

## Output to Input Reverse Leakage Protection

An internal circuit monitors the input and output voltages. When the output voltage is greater than the input voltage, the internal pass transistor and parasitic diodes turn off, and OUT powers the device. There is no leakage path from OUT to IN. Therefore, the output

can be powered from an auxiliary supply such as a backup battery without any need for additional blocking diodes.

## Current Limit

The MAX5005/MAX5006/MAX5007 include a current limiter that monitors and controls the pass transistor's gate voltage, limiting the output current to  $350\text{mA}$  (typ). For design purposes, consider the current limit to be  $160\text{mA}$  (min) to  $600\text{mA}$  (max). The output can be shorted to ground for an indefinite period without damaging the part.

## Thermal Protection

When the junction temperature exceeds  $T_J = +160^\circ\text{C}$ , an internal thermal sensor signals the shutdown logic, turning off the pass transistor and allowing the IC to cool. The thermal sensor turns the pass transistor on again after the IC's junction temperature decreases by  $20^\circ\text{C}$ , resulting in a pulsed output during continuous thermal overload conditions. Thermal overload protection is designed to protect the MAX5005/MAX5006/MAX5007 in the event of fault conditions. For continuous operation, do not exceed the absolute maximum junction temperature rating of  $T_J = +150^\circ\text{C}$ .

## Operating Region and Power Dissipation

The MAX5005/MAX5006/MAX5007's maximum power dissipation depends on the thermal resistance of the case and circuit board, the temperature difference between the die junction and the ambient air, and the rate of airflow. The power dissipation across the device is  $P = I_{\text{OUT}}(V_{\text{IN}} - V_{\text{OUT}})$ . The maximum power dissipation is:

$$P_{\text{MAX}} = (T_J - T_A) / (\Theta_{\text{JA}})$$

where  $T_J - T_A$  is the temperature difference between the die junction and the surrounding air,  $\Theta_{\text{JA}}$  is the thermal resistance of the package from junction to ambient.

The MAX5005/MAX5006/MAX5007's ground pin (GND) performs the dual function of providing an electrical connection to the system ground and channeling heat away. Connect GND to the system ground using a large pad or ground plane. For optimum performance, minimize trace inductance to D+, D-, and GND.

## Applications Information

### Capacitor Selection and Regulator Stability

For stable operation over the full temperature range and with load currents up to  $150\text{mA}$ , use a  $1\mu\text{F}$  (min) output capacitor. To reduce noise and improve load transient response, stability, and power-supply rejection, use large output capacitor values such as  $10\mu\text{F}$ .

# 150mA USB LDO Regulators with $\pm 15\text{kV}$ TVS and $\mu\text{P}$ Reset

Note that some ceramic dielectrics exhibit large capacitance and ESR variation with temperature. With dielectrics such as Z5U and Y5V, it may be necessary to use 2.2 $\mu\text{F}$  or more to ensure stability at temperatures below  $-10^{\circ}\text{C}$ . With X7R or X5R dielectrics, 1 $\mu\text{F}$  should be sufficient at all operating temperatures. Also, for high-ESR tantalum capacitors, 2.2 $\mu\text{F}$  or more may be needed to maintain stability. A graph of the Region of Stable  $\text{C}_{\text{OUT}}$  ESR vs. Load Current is shown in the *Typical Operating Characteristics*.

To improve power-supply rejection and transient response use a 1 $\mu\text{F}$  capacitor between IN and GND.

## Negative-Going $\text{V}_{\text{OUT}}$ Transients

These devices are relatively immune to short-duration, negative-going  $\text{V}_{\text{OUT}}$  transients. The *Typical Operating Characteristics* section shows a graph of the Maximum Pulse Duration vs. Reset Threshold Overdrive for which reset is not asserted. The graph was produced using negative going output transients starting at  $\text{V}_{\text{OUT}}$  and ending below the reset threshold by the magnitude indicated (Reset Threshold Overdrive). The graph shows the maximum pulse width that a negative going  $\text{V}_{\text{OUT}}$  transient can typically have without triggering a reset pulse. As the amplitude of the transient increases (i.e., goes further below the reset threshold), the maximum allowable pulse width decreases. Typically, a  $\text{V}_{\text{OUT}}$  transient that goes only 10mV below the reset threshold and lasts for 75 $\mu\text{s}$  will not trigger a reset pulse.

## USB $\pm 15\text{kV}$ Transient Voltage Suppression

The universal serial bus (USB) simplifies interconnectivity between peripheral devices and personal computers. USBs offer high-speed data communication rates (up to 12Mbps) using only two lines (D+ and D-). CMOS based USB peripherals that utilize deep submicron technologies are more susceptible to electrostatic discharge (ESD) failure due to shorter channel lengths, shallower drain/source junctions, and lightly doped drain structures. The MAX5005/MAX5006/MAX5007 incorporate a proprietary transient voltage suppression (TVS) circuit for use with submicron devices.

The TVS design complies with IEC-1000-4-2 level 4 (EN61000-4-2)  $\pm 15\text{kV}$  Air Discharge and  $\pm 8\text{kV}$  Contact Discharge as well as MIL STD 883C-Method 3015-6 level 3.

The TVS circuit handles up to 11A of surge current. The TVS/ESD structure is directly coupled to the output of the LDO regulator.

## TVS Surge Test Information

Figure 2 shows the test circuit used to generate the 8/40 $\mu\text{s}$  short circuit waveform of Figure 3. Figures 4, 5, and 6 show the actual surge current I/V characteristics with various capacitive loads.

## ESD Performance

The MAX5005/MAX5006/MAX5007 are characterized to the following limits on D+, D-, and IN:

- $\pm 15\text{kV}$  using the Human Body Model
- $\pm 8\text{kV}$  using the Contact Discharge Method specified in IEC 1000-4-2 (EN61000-4-2)
- $\pm 15\text{kV}$  using the Air-Gap Discharge Method specified in IEC 1000-4-2 (EN61000-4-2).

Note that in order to achieve the above ESD levels on IN, a ceramic 1 $\mu\text{F}$  ceramic capacitor should be connected from IN to GND.

## ESD Test Conditions

ESD performance depends on several conditions. Contact Maxim for a reliability report that documents test setup, methodology, and results.

## Human Body Model

Figure 7 shows the Human Body Model, and Figure 8 shows the current waveform it generates when discharged into low impedance. This model consists of a 100pF capacitor charged to the ESD voltage of interest, which is then discharged into the test device through a 1.5k $\Omega$  resistor.

## ESD Transmission Line Pulsing

Figure 9 shows the test circuit used for transmission line pulsing conditions. The 200ns pulsewidth has a rise time of 4ns. Figure 10 shows the Current vs. Voltage characteristics for various output capacitance values.

# 150mA USB LDO Regulators with $\pm 15\text{kV}$ TVS and $\mu\text{P}$ Reset

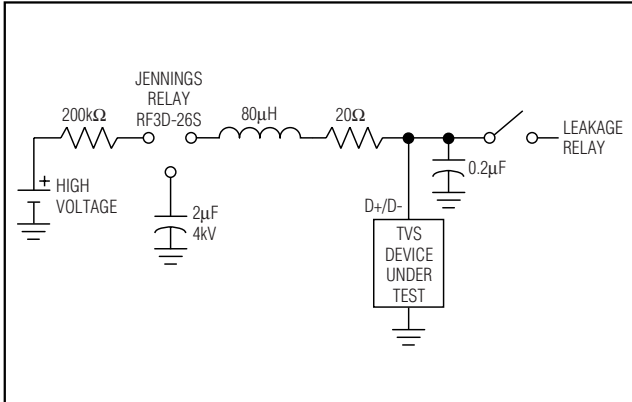

Figure 2. Surge Current Test Circuit

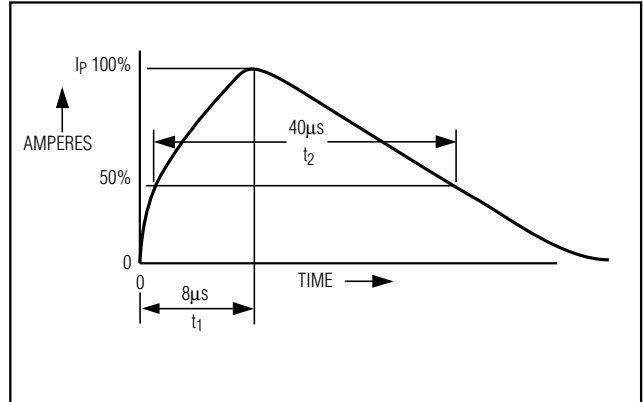

Figure 3. Test Circuit Surge Current Waveform (Short-Circuit Load)

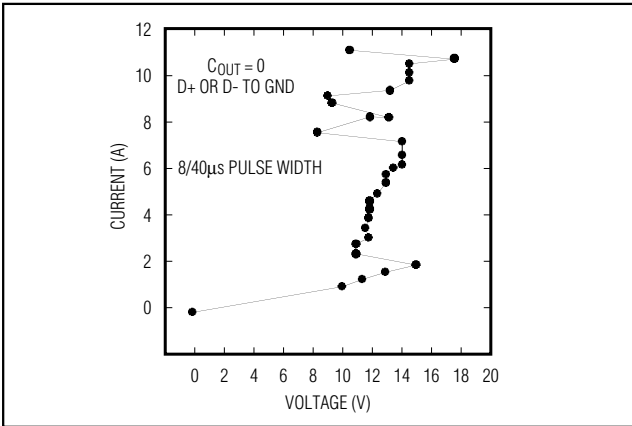

Figure 4. Surge Current I/V Characteristic ( $C_{OUT} = 0$ )

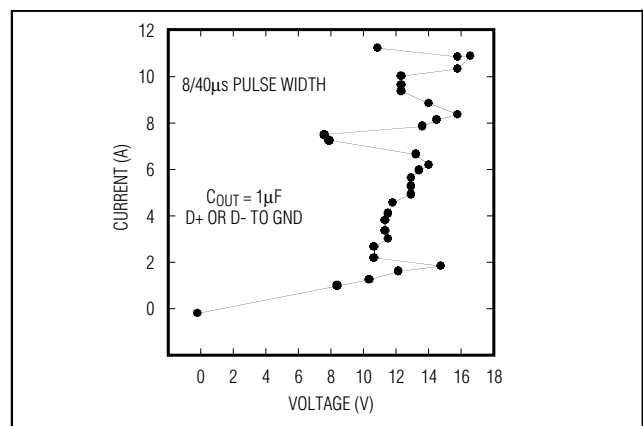

Figure 5. Surge Current I/V Characteristic ( $C_{OUT} = 1\mu\text{F}$ )

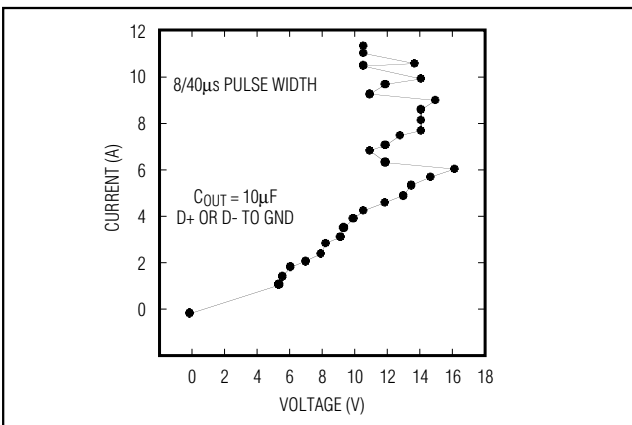

Figure 6. Surge Current I/V Characteristic ( $C_{OUT} = 10\mu\text{F}$ )

# 150mA USB LDO Regulators with $\pm 15kV$ TVS and $\mu P$ Reset

MAX5005/MAX5006/MAX5007

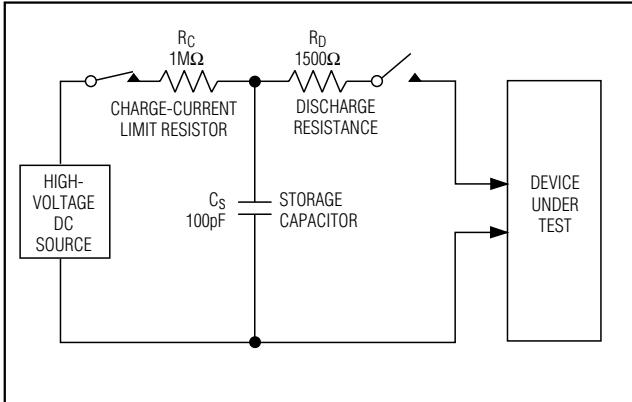

Figure 7. Human Body ESD Test Model

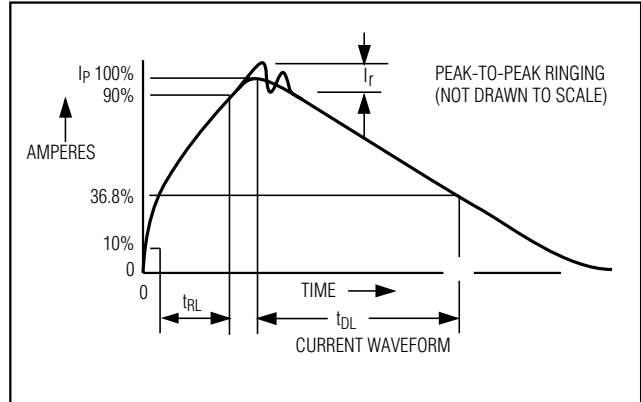

Figure 8. Human Body Model Current Waveform

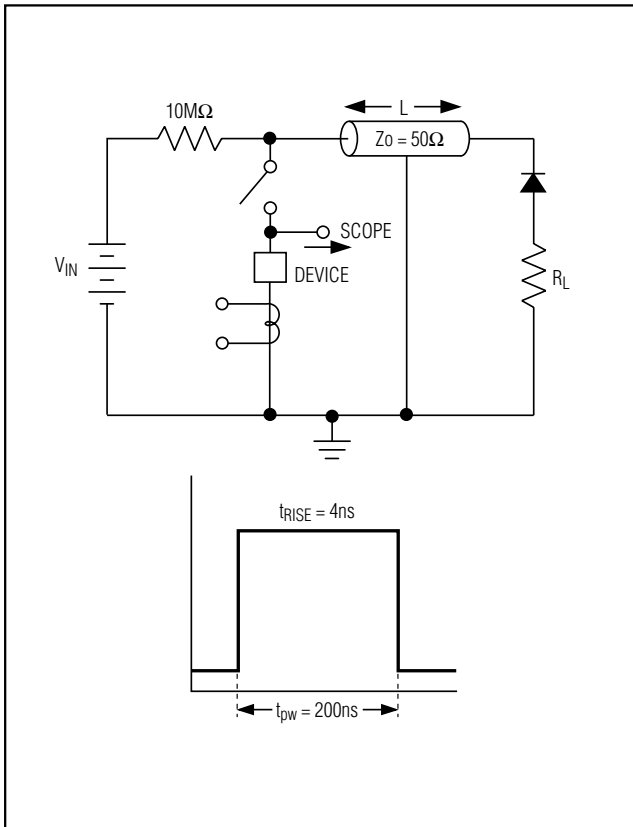

Figure 9. Transmission Line Pulsing Setup for ESD I/V Characteristics

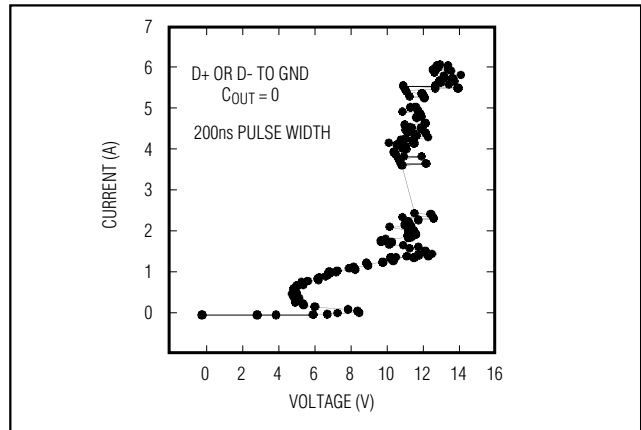

Figure 10. Transmission Line Pulsing I/V Characteristic ( $C_{OUT} = 0$ )

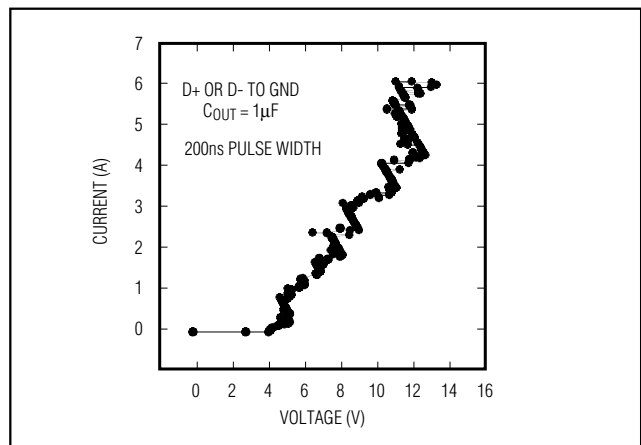

Figure 11. Transmission Line Pulsing I/V Characteristic ( $C_{OUT} = 1\mu F$ )

# 150mA USB LDO Regulators with $\pm 15\text{kV}$ TVS and $\mu\text{P}$ Reset

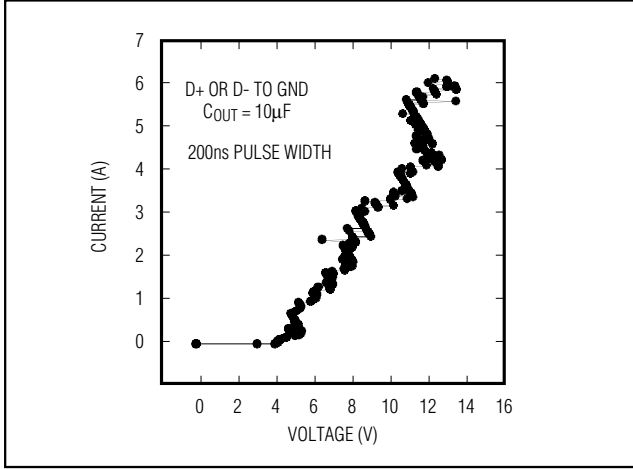

Figure 12. Transmission Line Pulsing I/V Characteristic (C<sub>OUT</sub> = 10µF)

## Chip Information

TRANSISTOR COUNT: 890

PROCESS: BiCMOS

# 150mA USB LDO Regulators with $\pm 15kV$ TVS and $\mu P$ Reset

## Package Information

(The package drawing(s) in this data sheet may not reflect the most current specifications. For the latest package outline information go to [www.maxim-ic.com/packages](http://www.maxim-ic.com/packages).)

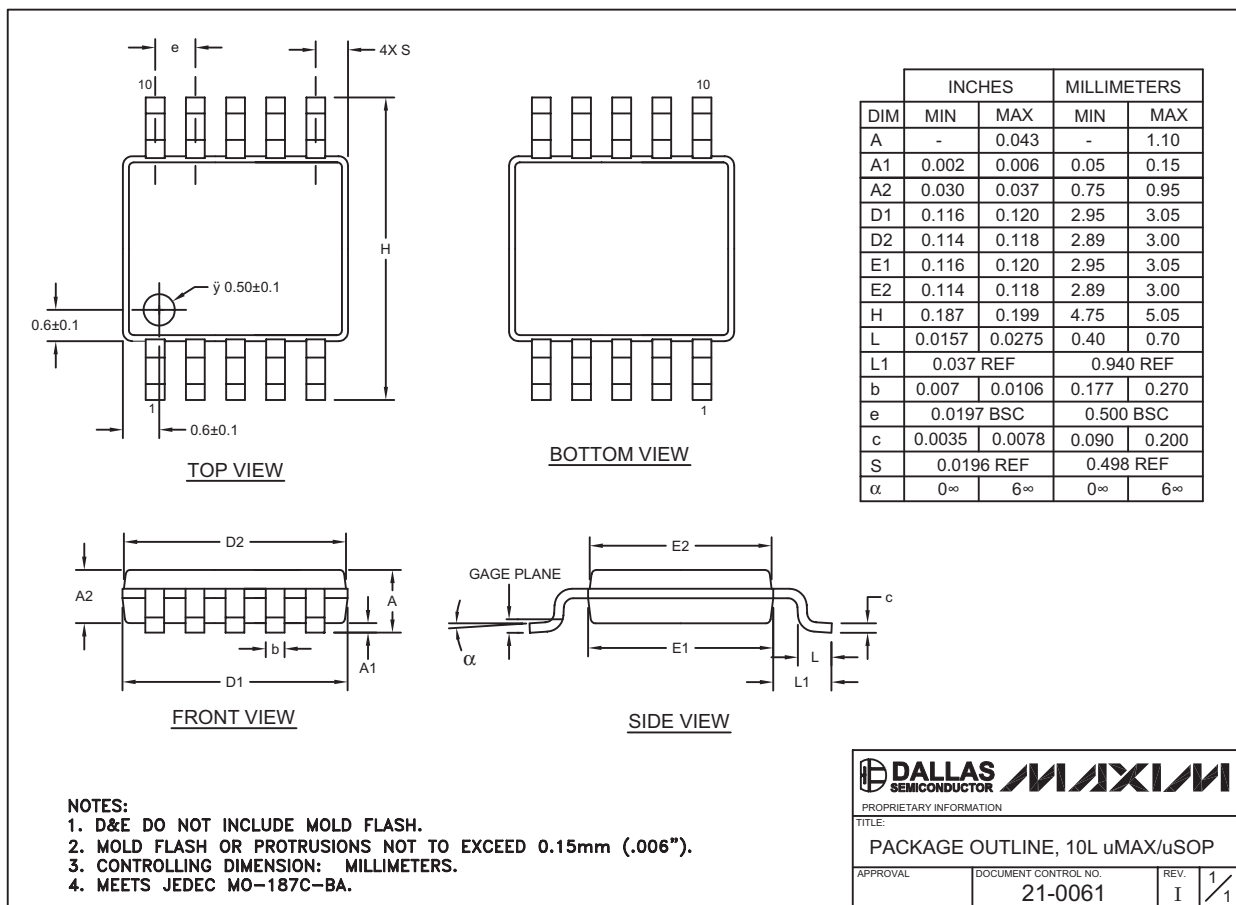



10L uMAX/eps  
MAX5005/MAX5006/MAX5007

Maxim cannot assume responsibility for use of any circuitry other than circuitry entirely embodied in a Maxim product. No circuit patent licenses are implied. Maxim reserves the right to change the circuitry and specifications without notice at any time.

Maxim Integrated Products, 120 San Gabriel Drive, Sunnyvale, CA 94086 408-737-7600 13

## Looking for pricing, stock, or lifecycle information?

Click below to explore more details on WIN SOURCE:

-  [View MAX5005BCUB+T on WIN SOURCE](#)
-  [Maxim Integrated](#) Information

## Optimize Your Supply Chain with WIN SOURCE Solutions

-  Global Sourcing Solution
-  Obsolete Management
-  Cost Control Management
-  Shortage Management
-  Alternative Solution
-  Excess Inventory Management