



**THE DATASHEET OF  
MAX5023SASA+**



## General Description

The MAX5023/MAX5024 high-voltage linear regulators operate from a +6.5V to +65V input voltage and deliver up to 150mA of output current. These devices consume only 60 $\mu\text{A}$  of quiescent current with no load and withstand a -60V reverse-battery voltage at the input. The MAX5023/MAX5024 include an active-low internal microprocessor ( $\mu\text{P}$ ) reset circuit that asserts when the regulator output drops below the preset output voltage threshold by 7.5% or 12.5%, depending on the device selected. Both devices are available with a fixed +3.3V or +5V output. These devices are short-circuit protected and include thermal shutdown.

In addition to an enable input to turn on or off the regulator, the MAX5023/MAX5024 include a  $\overline{\text{HOLD}}$  input that allows for the implementation of a self-holding circuit without requiring external components. Setting  $\overline{\text{HOLD}}$  low after enabling the regulator, forces the regulator to remain on even if EN is subsequently set low. Releasing  $\overline{\text{HOLD}}$  shuts down the regulator.

The MAX5023 includes a watchdog input that monitors a pulse train from the  $\mu\text{P}$  and generates reset pulses if the watchdog input remains high or low for a duration longer than the 1.6s watchdog timeout period. The MAX5024 includes a SET input which, when connected to ground, selects a preset output voltage of +3.3V (MAX5024S/MAX5024T) or +5V (MAX5024L/MAX5024M). Set the adjustable output voltage by connecting SET to the regulator's output through a resistive-divider network.

The MAX5023/MAX5024 operate over the automotive temperature range (-40°C to +125°C) and are available in a thermally enhanced, surface-mount 8-pin SO-EP package.

## Applications

- Automotive
- Industrial
- Home Security
- Fire/Smoke Alarms
- Telecom/Networking

## Features

- Wide Operating Input Voltage Range +6.5V to +65V
- Thermally Enhanced 8-Pin SO Package with Exposed Pad Dissipates 1.5W
- Guaranteed 150mA Output Current
- 60 $\mu\text{A}$  No-Load Supply Current
- -60V Reverse-Battery Protection
- Preset +3.3V or +5.0V Output Voltage
- Thermal and Short-Circuit Protection
- Operate Over -40°C to +125°C Temperature Range
- Integrated  $\mu\text{P}$  Reset Circuit
- Watchdog Timer with 1.6s Timeout Period (MAX5023)
- Regulator Enable and Hold Inputs Implement Self-Holding Circuit
- SET Input for Adjustable Output Voltage (MAX5024)

*Selector Guide and Ordering Information appear at end of data sheet.*

## Typical Operating Circuit

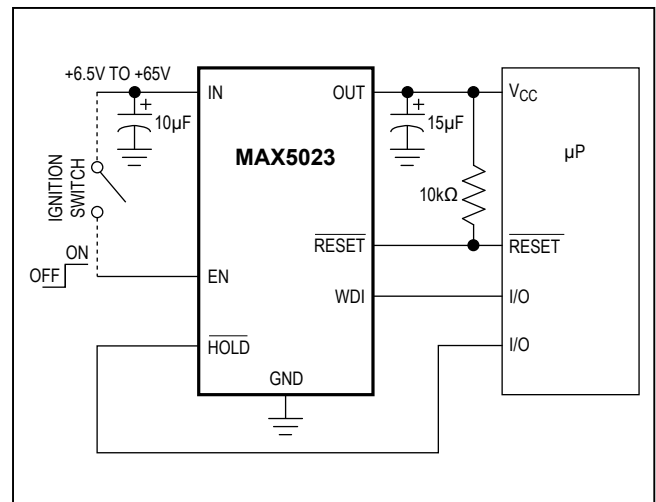

### Absolute Maximum Ratings

IN to GND.....	-60V to +70V	Continuous Power Dissipation ( $T_A = +70^\circ\text{C}$ )
EN to GND .....	-0.3V to ( $V_{IN} + 0.3\text{V}$ )	8-Pin SO-EP (derate 19.2mW/ $^\circ\text{C}$ above $+70^\circ\text{C}$ ).....
HOLD to GND .....	-0.3V to ( $V_{OUT} + 0.3\text{V}$ )	Operating Temperature Range.....
SET, WDI, OUT to GND .....	-0.3V to +13.2V	Junction Temperature.....
RESET to GND (Open Drain) .....	-0.3V to +13.2V	Storage Temperature Range.....
Short-Circuit Duration ( $V_{IN} \leq +14\text{V}$ ) .....	Continuous	Lead Temperature (soldering, 10s) .....
Maximum Current to Any Pin (Except IN, OUT) .....	$\pm 20\text{mA}$	

Stresses beyond those listed under "Absolute Maximum Ratings" may cause permanent damage to the device. These are stress ratings only, and functional operation of the device at these or any other conditions beyond those indicated in the operational sections of the specifications is not implied. Exposure to absolute maximum rating conditions for extended periods may affect device reliability.

### Package Thermal Characteristics (Note 1)

SO-EP

Junction-to-Ambient Thermal Resistance ( $\theta_{JA}$ ).....	41 $^\circ\text{C/W}$
Junction-to-Case Thermal Resistance ( $\theta_{JC}$ ).....	2 $^\circ\text{C/W}$

**Note 1:** Package thermal resistances were obtained using the method described in JEDEC specification JESD51-7, using a four-layer board. For detailed information on package thermal considerations, refer to [www.maximintegrated.com/thermal-tutorial](http://www.maximintegrated.com/thermal-tutorial).

### Electrical Characteristics

( $V_{IN} = +14\text{V}$ ,  $I_{OUT} = 1\text{mA}$ ,  $C_{IN} = 10\mu\text{F}$ ,  $C_{OUT} = 15\mu\text{F}$ ,  $V_{EN} = +2.4\text{V}$ ,  $\overline{\text{HOLD}} = \text{open}$ , 10k $\Omega$  from  $\overline{\text{RESET}}$  to OUT,  $T_A = -40^\circ\text{C}$  to  $+125^\circ\text{C}$ , unless otherwise noted. Typical specifications are at  $T_A = +25^\circ\text{C}$ .) (Note 2)

PARAMETER	SYMBOL	CONDITIONS	MIN	TYP	MAX	UNITS
Input Voltage Range	$V_{IN}$	$V_{IN}$ must be at least 1.5V greater than $V_{OUT}$	6.5		65	V
Reverse Input Current	$I_{REVERSE}$	$V_{IN} = -60\text{V}$		0.1	10	$\mu\text{A}$
Supply Current	$I_Q$	Measured at GND	$I_{OUT} = 0\text{mA}$	58	140	$\mu\text{A}$
			$I_{OUT} = 150\text{mA}$	2000		
Shutdown Supply Current	$I_{SHDN}$	$V_{EN} \leq +0.4\text{V}$		6	16	$\mu\text{A}$
<b>REGULATOR</b>						
Guaranteed Output Current	$I_{OUT}$	$V_{OUT} = +5\text{V}$	150			mA
Output Voltage	$V_{OUT}$	SET = GND, $I_{OUT} = 1\text{mA}$ to 150mA, 5V version	4.8	5	5.2	V
		SET = GND, $I_{OUT} = 1\text{mA}$ to 150mA, 3.3V version	3.168	3.3	3.432	
		$I_{OUT} = 5\text{mA}$ , adjustable version (MAX5024)	2.5		11	
Dropout Voltage	$\Delta V_{DO}$	$I_{LOAD} = 150\text{mA}$ , $V_{OUT} = +5\text{V}$ (Note 3)		0.9	1.5	V
Startup Response Time		Rising edge of $V_{IN}$ to $V_{OUT}$ , $R_L = 500\Omega$ , SET = GND		400		$\mu\text{s}$
Line Regulation	$\frac{\Delta V_{OUT}}{\Delta V_{IN}}$	$+8\text{V} \leq V_{IN} \leq +65\text{V}$	+5V version	-1	+1	mV/V
			+3.3V version	-0.5	0.5	

**Electrical Characteristics (continued)**

( $V_{\text{IN}} = +14\text{V}$ ,  $I_{\text{OUT}} = 1\text{mA}$ ,  $C_{\text{IN}} = 10\mu\text{F}$ ,  $C_{\text{OUT}} = 15\mu\text{F}$ ,  $V_{\text{EN}} = +2.4\text{V}$ ,  $\overline{\text{HOLD}} = \text{open}$ ,  $10\text{k}\Omega$  from  $\overline{\text{RESET}}$  to OUT,  $T_{\text{A}} = -40^{\circ}\text{C}$  to  $+125^{\circ}\text{C}$ , unless otherwise noted. Typical specifications are at  $T_{\text{A}} = +25^{\circ}\text{C}$ .) (Note 2)

PARAMETER	SYMBOL	CONDITIONS	MIN	TYP	MAX	UNITS
Enable Voltage	$V_{\text{EN}}$	EN = high, regulator on	2.4			V
		EN = low, regulator off			0.4	
Enable Input Current	$I_{\text{EN}}$	$V_{\text{EN}} = +2.4\text{V}$		0.5		$\mu\text{A}$
		$V_{\text{EN}} = +14\text{V}$		4		
$\overline{\text{HOLD}}$ Voltage	$V_{\text{IL}}$	Regulator on, EN transition from high to low			0.4	V
$\overline{\text{HOLD}}$ Release Voltage	$V_{\text{IH}}$	EN = low, regulator shuts off	$V_{\text{OUT}} - 0.4\text{V}$			V
$\overline{\text{HOLD}}$ Pullup Current	$I_{\overline{\text{HOLD}}}$	Internally connected to OUT		4		$\mu\text{A}$
SET Reference Voltage	$V_{\text{SET}}$	$I_{\text{OUT}} = 10\text{mA}$	1.223	1.248	1.273	V
SET Input Leakage Current	$I_{\text{SET}}$			0.5	100	nA
Load Regulation	$\frac{\Delta V_{\text{OUT}}}{\Delta I_{\text{OUT}}}$	$I_{\text{OUT}} = 1\text{mA}$ to $150\text{mA}$		1		mV/mA
Power-Supply Rejection Ratio	PSRR	$I_{\text{OUT}} = 10\text{mA}$ , $f = 100\text{Hz}$ , $500\text{mV}_{\text{P-P}}$ , $V_{\text{OUT}} = +5\text{V}$		54		dB
Short-Circuit Current	$I_{\text{SC}}$	$V_{\text{IN}} = +8\text{V}$	175	300		mA
Thermal-Shutdown Temperature	$T_{\text{J(SHDN)}}$			150		$^{\circ}\text{C}$
Thermal-Shutdown Hysteresis	$\Delta T_{\text{J(SHDN)}}$			20		$^{\circ}\text{C}$
<b>RESET CIRCUIT</b>						
Reset Threshold	$V_{\text{TH}}$	MAX502_L, SET = GND	4.50	4.625	4.75	V
		MAX502_M, SET = GND	4.25	4.375	4.50	
		MAX502_T, SET = GND	2.970	3.052	3.135	
		MAX502_S, SET = GND	2.805	2.887	2.970	
		MAX5024L/T, SET = Divider (Figure 1) (Note 4)	$0.925 \times V_{\text{OUT}}$			
		MAX5024M/S, SET = Divider (Figure 1) (Note 4)	$0.875 \times V_{\text{OUT}}$			
Reset Timeout Period	$t_{\text{RP}}$		140	200	260	ms
$V_{\text{OUT}}$ to Reset Delay	$t_{\text{RD}}$	$V_{\text{OUT}}$ falling		5		$\mu\text{s}$

**Electrical Characteristics (continued)**

( $V_{IN} = +14V$ ,  $I_{OUT} = 1mA$ ,  $C_{IN} = 10\mu F$ ,  $C_{OUT} = 15\mu F$ ,  $V_{EN} = +2.4V$ ,  $\overline{HOLD} = \text{open}$ ,  $10k\Omega$  from  $\overline{RESET}$  to  $OUT$ ,  $T_A = -40^\circ C$  to  $+125^\circ C$ , unless otherwise noted. Typical specifications are at  $T_A = +25^\circ C$ .) (Note 2)

PARAMETER	SYMBOL	CONDITIONS	MIN	TYP	MAX	UNITS
Open-Drain $\overline{RESET}$ Output Voltage (Note 5)	$V_{OL}$	$V_{OUT} \geq +1.0V$ , $I_{SINK} = 50\mu A$ , $\overline{RESET}$ asserted			0.3	V
		$V_{OUT} \geq +2.85V$ , $I_{SINK} = 1.2mA$ , $\overline{RESET}$ asserted			0.3	
		$V_{OUT} \geq +4.25V$ , $I_{SINK} = 3.2mA$ , $\overline{RESET}$ asserted			0.4	
Open-Drain $\overline{RESET}$ Output-Leakage Current	$I_{LKG}$	$\overline{RESET}$ not asserted, $V_{\overline{RESET}} = +11V$			1.0	$\mu A$
<b>WATCHDOG FUNCTION</b>						
Watchdog Timeout Period	$t_{WD}$		1.12	1.6	2.08	s
WDI Pulse Width	$t_{WDI}$	(Note 6)		50		ns
WDI Input Voltage	$V_{IL}$				0.4	V
	$V_{IH}$		2.4			
WDI Input Current	$I_{WDI}$	WDI = GND	-1		+1	$\mu A$

**Note 2:** Limits at  $-40^\circ C$  are guaranteed by characterization and not production tested.

**Note 3:** Dropout voltage is defined as  $V_{IN} - V_{OUT}$  when  $V_{OUT}$  is 100mV below the value of  $V_{OUT}$  for  $V_{IN} = V_{OUT} + 3V$ .

**Note 4:**  $V_{OUT} = V_{SET} (1 + R1/R2) = 1.248V (1 + R1/R2)$ .

**Note 5:**  $\overline{RESET}$  is guaranteed to be in the correct logic state for  $V_{OUT} > +1V$ .

**Note 6:** Guaranteed by design, not production tested.

**Typical Operating Characteristics**

( $V_{IN} = +14V$ ,  $C_{IN} = 10\mu F$ ,  $C_{OUT} = 15\mu F$ ,  $V_{EN} = +2.4V$ ,  $V_{OUT} = +5V$ ,  $SET = GND$ ,  $T_A = +25^\circ C$ , unless otherwise specified.)

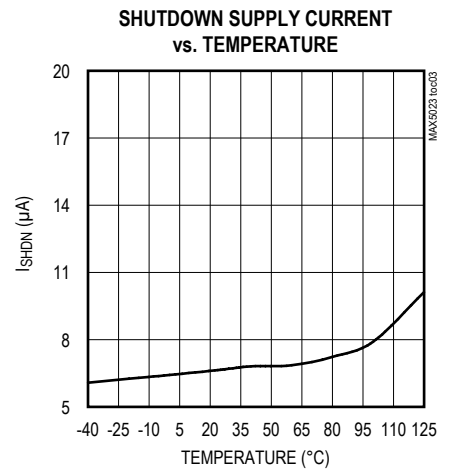
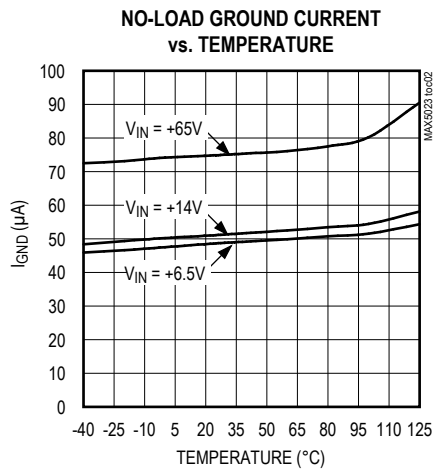
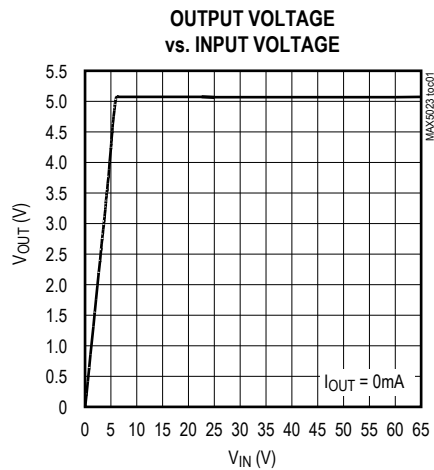

Typical Operating Characteristics (continued)

( $V_{IN} = +14V$ ,  $C_{IN} = 10\mu F$ ,  $C_{OUT} = 15\mu F$ ,  $V_{EN} = +2.4V$ ,  $V_{OUT} = +5V$ ,  $SET = GND$ ,  $T_A = +25^\circ C$ , unless otherwise specified.)

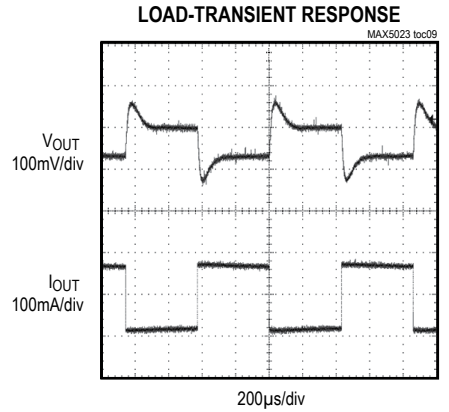
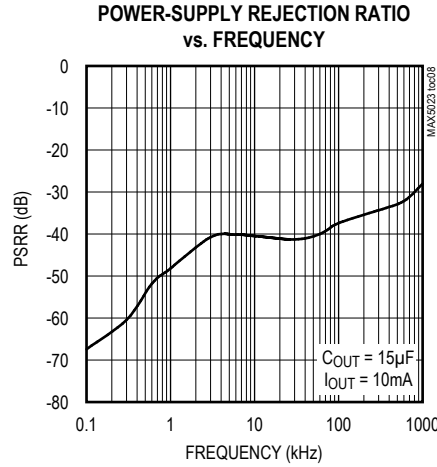
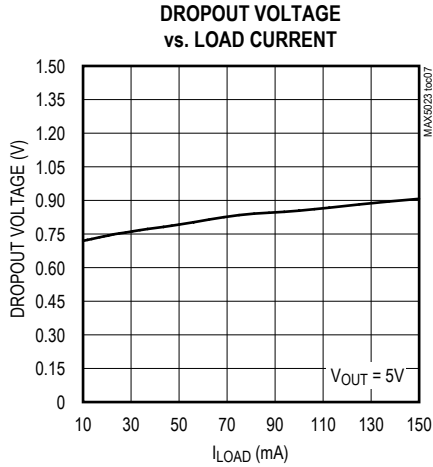
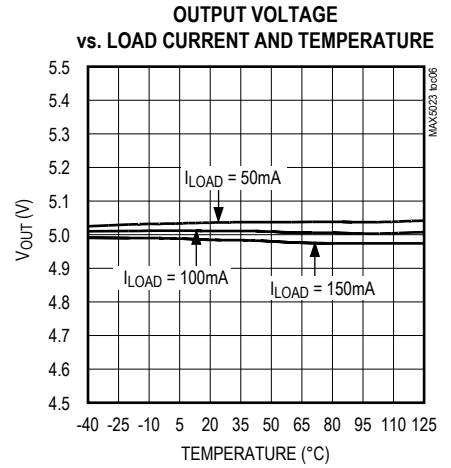
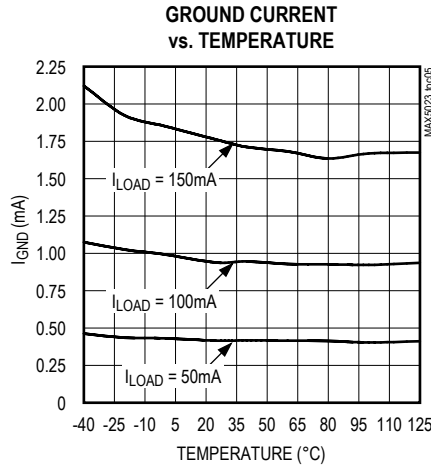
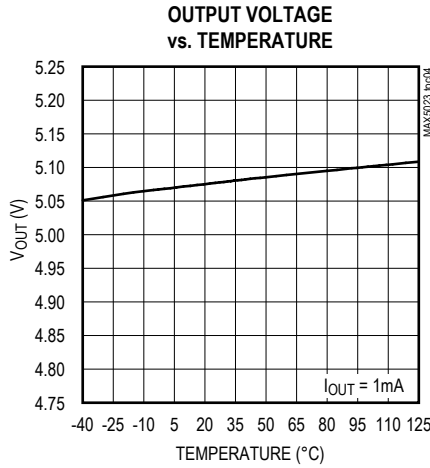

Typical Operating Characteristics (continued)

( $V_{IN} = +14V$ ,  $C_{IN} = 10\mu F$ ,  $C_{OUT} = 15\mu F$ ,  $V_{EN} = +2.4V$ ,  $V_{OUT} = +5V$ ,  $SET = GND$ ,  $T_A = +25^\circ C$ , unless otherwise specified.)

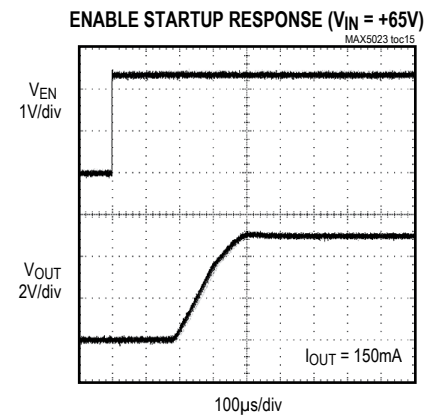
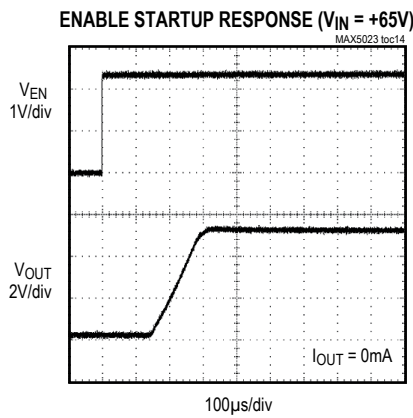
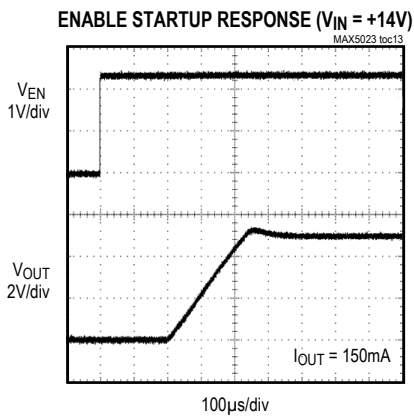
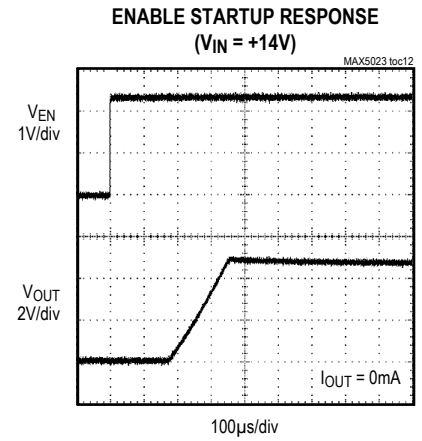
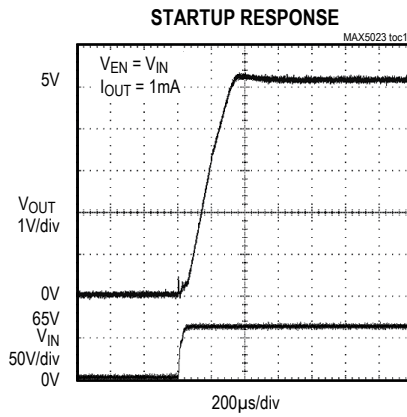
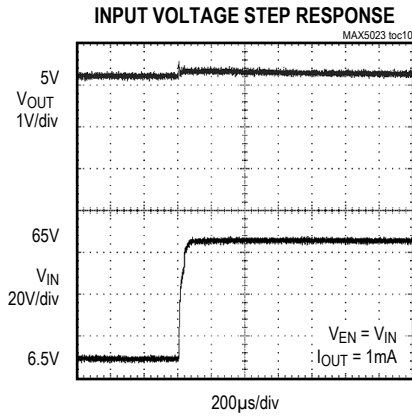

Typical Operating Characteristics (continued)

( $V_{IN} = +14V$ ,  $C_{IN} = 10\mu F$ ,  $C_{OUT} = 15\mu F$ ,  $V_{EN} = +2.4V$ ,  $V_{OUT} = +5V$ , SET = GND,  $T_A = +25^\circ C$ , unless otherwise specified.)

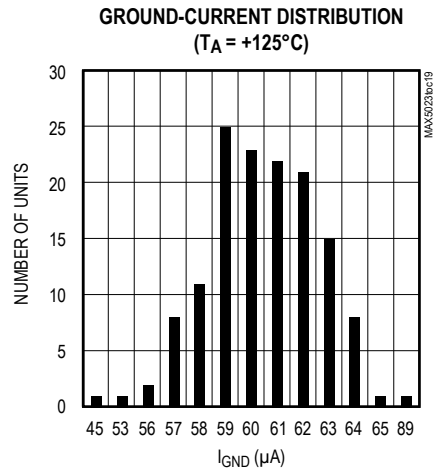
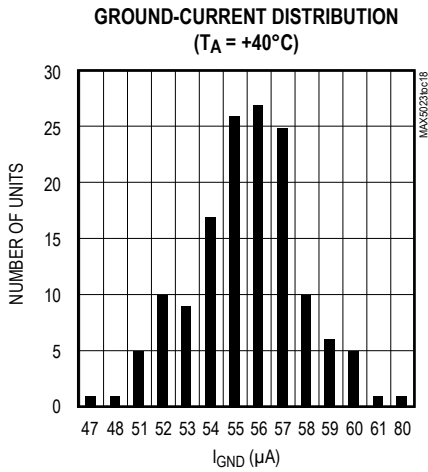
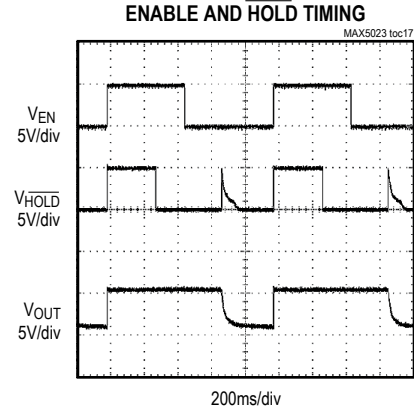
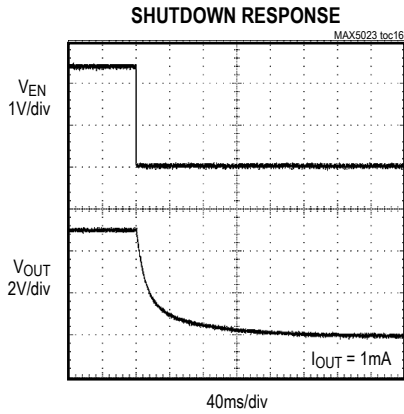

Pin Configurations

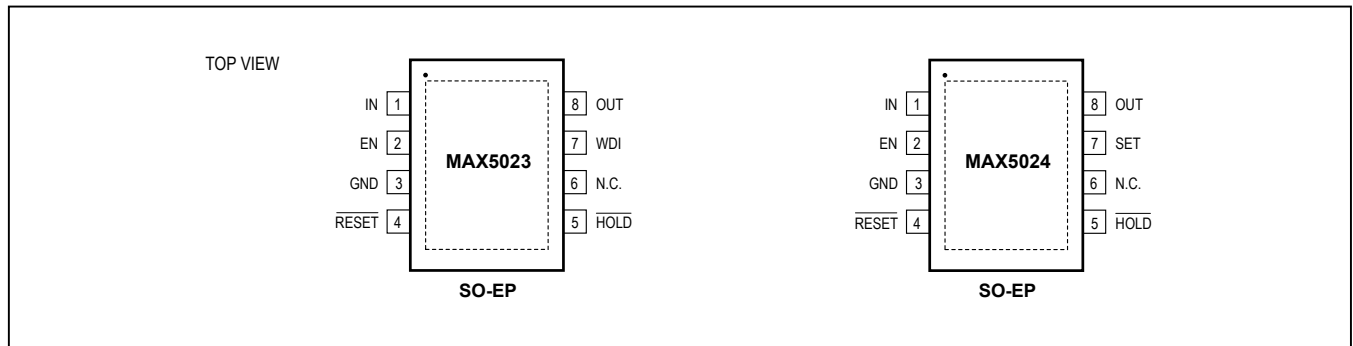

Pin Description

PIN		NAME	FUNCTION
MAX5023	MAX5024		
1	1	IN	Regulator Input. Supply voltage ranges from +6.5V to +65V. Bypass with a 10 $\mu$ F capacitor to GND.
2	2	EN	Enable Input. Force EN high to turn on the regulator. Pull EN low and force $\overline{\text{HOLD}}$ high (or open circuit) to place the device in shutdown mode. Internally connected to ground through a 5M $\Omega$ resistor.
3	3	GND	Ground. GND also functions as a heatsink. Solder to large pads or the circuit-board ground plane to maximize thermal dissipation.
4	4	$\overline{\text{RESET}}$	Active-Low Open-Drain Reset Output. $\overline{\text{RESET}}$ remains low while $V_{\text{OUT}}$ is below the reset threshold or when WDI is not pulsed within 1.6s. $\overline{\text{RESET}}$ remains low for the duration of the reset timeout period after the reset conditions are terminated.
5	5	$\overline{\text{HOLD}}$	Regulator Hold Input. When $\overline{\text{HOLD}}$ is forced low, the regulator stores the on state of the output allowing the regulator to function even if EN is pulled low. To shutdown the regulator, release $\overline{\text{HOLD}}$ after EN is pulled low. If $\overline{\text{HOLD}}$ is unused, either float $\overline{\text{HOLD}}$ or connect to OUT. Internally connected to OUT through a 4 $\mu$ A pullup current source (see Table 1, Truth Table).
6	6	N.C.	No Connection. Not internally connected.
7	—	WDI	Watchdog Timer Input (MAX5023 only). The watchdog timer asserts a reset if WDI does not transition within the 1.6s watchdog timeout period. WDI <b>cannot</b> be disabled.
8	8	OUT	Regulator Output. Fixed (+3.3V or +5V) or adjustable (+2.5V to +11V). Bypass with a 15 $\mu$ F capacitor (min).
—	7	SET	Feedback Input for Setting the Output Voltage. Connect to GND to set the output voltage to the preset fixed value (+3.3V or +5V). Connect to an external resistor-divider network for adjustable output operation (MAX5024 only).
—	—	EP	Exposed Pad. Connect pad to GND.

**Detailed Description**

The MAX5023/MAX5024 high-voltage linear regulators include an integrated  $\mu$ P reset circuit and watchdog timer/adjustable output voltage. The devices guarantee 150mA load drive and are available with preset output voltages of +3.3V or +5V. The MAX5023 features a watchdog timer (WDI) with a 1.6s timeout period. The MAX5024 offers an adjustable output voltage using an external resistive-divider network between SET and OUT. The internal reset circuit monitors the regulator output voltage and asserts a reset output when the regulator output falls below the  $\mu$ P supply tolerance. Other features include reverse-voltage protection to -60V, enable (EN) and hold (HOLD) regula-

tor control inputs, 16 $\mu$ A (max) shutdown current, short-circuit protection, and thermal shutdown.

**Regulator**

The regulator accepts an input voltage range from +6.5V to +65V. The MAX5023/MAX5024 offer fixed output voltages of +3.3V and +5V. The MAX5024 also features an adjustable output voltage that is implemented with an external resistive-divider network connected between OUT, SET, and GND (Figure 1). The MAX5024 automatically determines the feedback path depending on the voltage at SET. Featured characteristics include reverse-voltage protection to -60V and enable and hold regulator control inputs. The *Typical Operating Circuit* shows a self-holding configuration for the MAX5023.

**Functional Diagram**

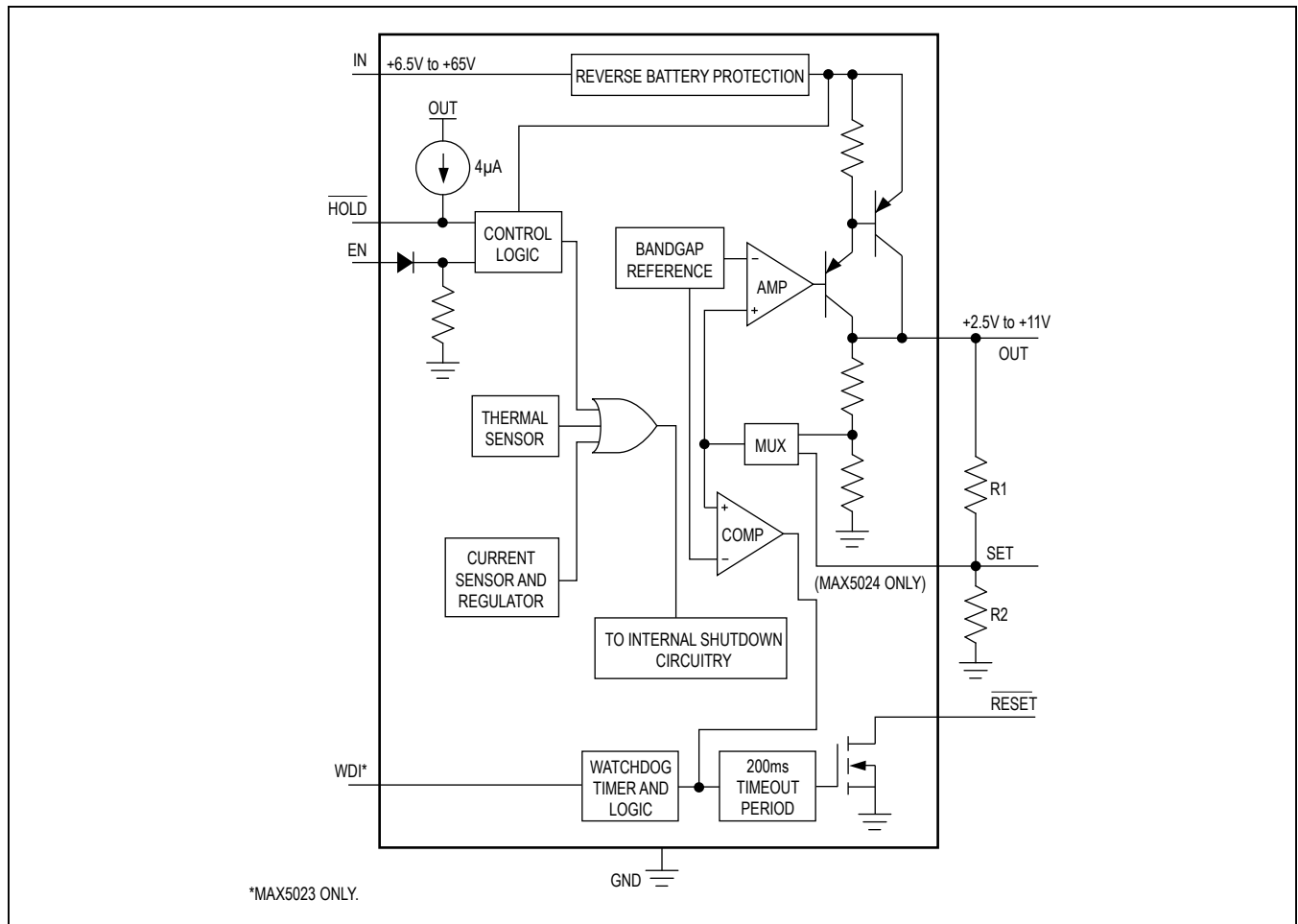

Figure 1. Functional Diagram

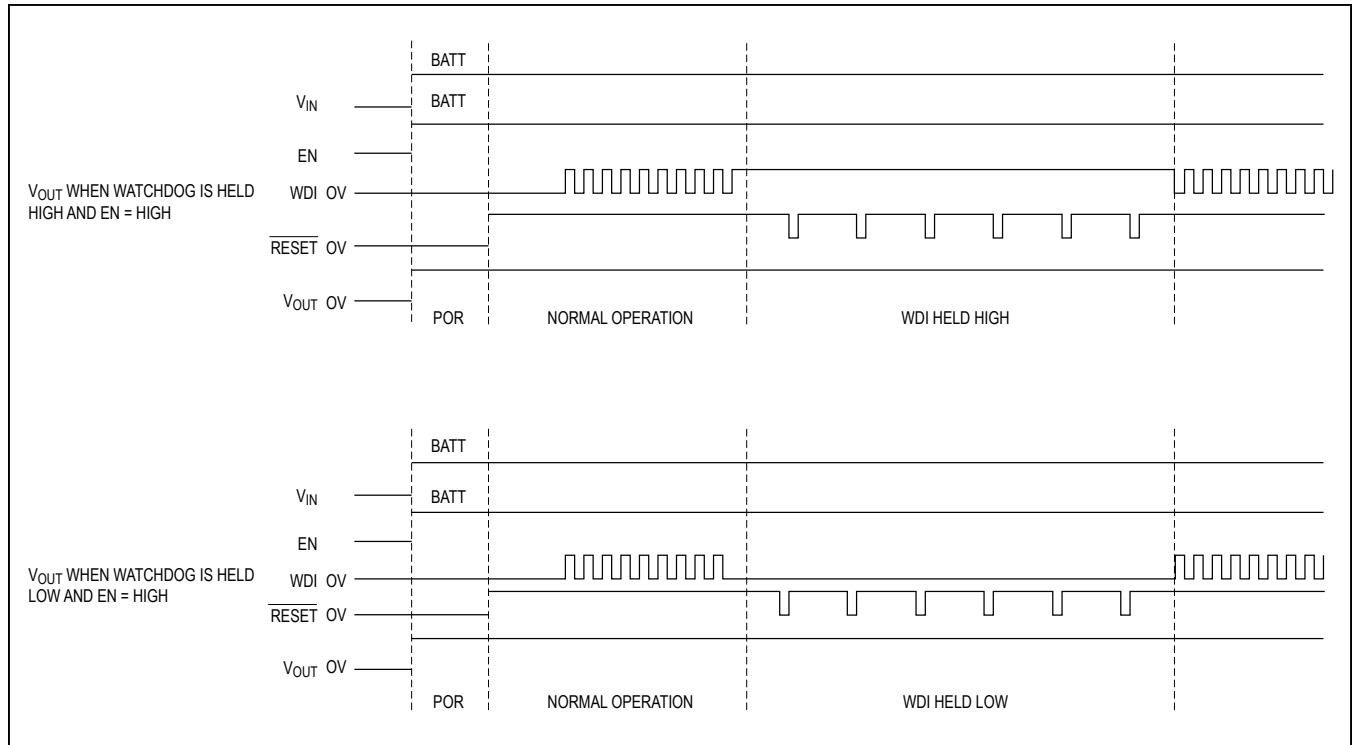

Figure 2. Watchdog Operation Timing Diagram

### Reset Output

The reset supervisor circuit is fully integrated in the MAX5023/MAX5024 and uses the same reference voltage as the regulator.  $\overline{\text{RESET}}$  asserts during power-up/down and brownout conditions.  $\overline{\text{RESET}}$  goes low if  $V_{\text{OUT}}$  drops below the preset output voltage threshold, and remains low for 200ms (reset timeout period,  $t_{\text{RP}}$ ) after  $V_{\text{OUT}}$  rises above the reset voltage threshold. For the MAX5023 only,  $\overline{\text{RESET}}$  also asserts when WDI does not transition for 1.6s (watchdog timeout period,  $t_{\text{WD}}$ ). Two supply tolerance reset thresholds, -7.5% and -12.5%, are available for each device type.

### Watchdog Timer (MAX5023 only)

A watchdog timer asserts  $\overline{\text{RESET}}$  if the watchdog input (WDI) is not toggled for 1.6s (watchdog timeout period,  $t_{\text{WD}}$ ).  $\overline{\text{RESET}}$  remains low for 200ms (reset timeout period,  $t_{\text{RP}}$ ). If the watchdog is not updated for lengthy periods of time, the reset output appears as a pulse train, asserted for 200ms, deasserted for 1.6s, until WDI is toggled again. Once  $\overline{\text{RESET}}$  asserts, it stays low for the entire reset timeout period ignoring any WDI transition during the reset timeout period. Figure 2 shows the

Watchdog Operation Timing Diagram. To prevent the watchdog from asserting  $\overline{\text{RESET}}$ , toggle WDI with a valid rising or falling edge prior to  $t_{\text{WD}}$  (min) = 1.12s. The watchdog counter clears when WDI toggles prior to  $t_{\text{WD}}$  or when  $\overline{\text{RESET}}$  asserts. The watchdog resumes counting after  $\overline{\text{RESET}}$  deasserts.

### Enable and Hold Inputs

The MAX5023/MAX5024 support two logic inputs, EN (active high) and  $\overline{\text{HOLD}}$  (active low), making these devices “automotive friendly.” For example, the ignition drives EN high, the regulator turns on and remains on even if EN goes low, as long as  $\overline{\text{HOLD}}$  is forced low and stays low after initial regulator power-up. This feature makes it possible to implement a self-holding circuit without external components. Release  $\overline{\text{HOLD}}$  (an internal current source connects HOLD to OUT) to turn the regulator off.

Force EN low and  $\overline{\text{HOLD}}$  high to place the MAX5023/MAX5024 into shutdown mode. Shutdown mode draws less than 16 $\mu$ A of supply current. Table 1 shows the state of the regulator output with respect to the voltage level at

EN and  $\overline{\text{HOLD}}$ . Figure 3 shows the timing diagram for the enable and hold functions. Connecting  $\overline{\text{HOLD}}$  to OUT or floating  $\overline{\text{HOLD}}$  allows the EN input to act as a standard ON/OFF switch for the regulator output.

**Thermal Protection**

When the junction temperature exceeds  $T_J = +150^\circ\text{C}$ , an internal thermal sensor signals the shutdown logic that turns off the pass transistor and allows the IC to cool. The thermal sensor turns the pass transistor on again after the IC's junction temperature cools by  $20^\circ\text{C}$ , resulting in a cycled output during continuous thermal-overload conditions. Thermal protection protects the MAX5023/

MAX5024 in the event of fault conditions. For continuous operation, do not exceed the absolute maximum junction temperature rating of  $T_J = +150^\circ\text{C}$ .

**Applications Information**

**Output-Voltage Selection (MAX5024 only)**

The MAX5024 features Dual Mode™ operation; it operates in either a preset voltage mode or an adjustable mode. In preset voltage mode, internal trimmed feedback resistors set the MAX5024's internal linear regulator to +3.3V or +5V (see the *Selector Guide*).

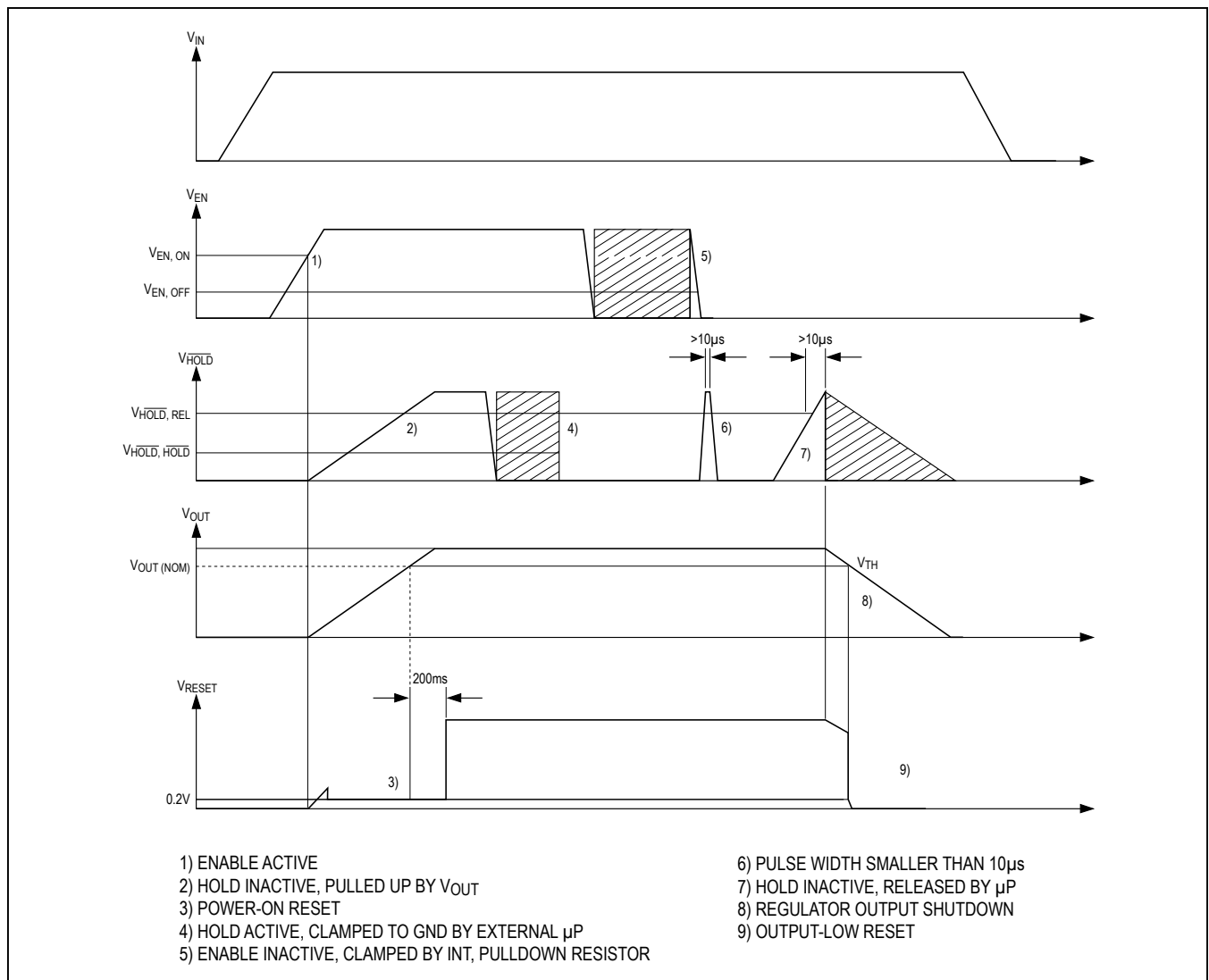

Figure 3. Enable and Hold Behavior

Dual Mode is a trademark of Maxim Integrated Products, Inc.

**Table 1. Truth Table for Regulator Output State**

ORDER	EN	HOLD	OUT	Comments
1	Low	X	Off	Initial state. EN has 5M $\Omega$ internal resistor to ground. HOLD has internal current source to OUT.
2	High	X	On	Regulator output is active when EN is pulled high.
3	High	Low	On	Hold is asserted forcing the regulator output on even if EN goes low.
4	X	Low	On	Self-holding state. Regulator output stays on regardless of the state of EN.
5	Low	High	Off	Regulator output is shutdown by releasing HOLD while EN remains low.

X = Don't care.

Select preset voltage mode by connecting SET to ground. In adjustable mode, select an output between +2.5V and +11V using two external resistors connected as a voltage-divider to SET (Figure 4). Set the output voltage using the following equation:

$$V_{OUT} = V_{SET} (1 + R1/R2)$$

where  $V_{SET} = 1.248V$  and  $R2 \approx 100k\Omega$ .

**Available Output-Current Calculation**

The MAX5023/MAX5024 high-voltage regulator provides up to 150mA of output current. The input voltage extends to +65V. Package power dissipation limits the amount of output current available for a given input/output voltage and ambient temperature. Figure 5 depicts the maximum power dissipation curve for these devices. The graph assumes that the exposed metal pad of the MAX5023/MAX5024 package is soldered to 1in<sup>2</sup> of PCB copper.

Use Figure 5 to determine the allowable package dissipation for a given ambient temperature. Alternately, use the following formula to calculate the allowable package dissipation:

$$P_D = \begin{cases} 1.538 \text{ W for } T_A \leq +70^\circ\text{C} \\ 1.538 - 0.01923 (T_A - 70^\circ\text{C}) \text{ for } +70^\circ\text{C} < T_A \leq +125^\circ\text{C} \end{cases}$$

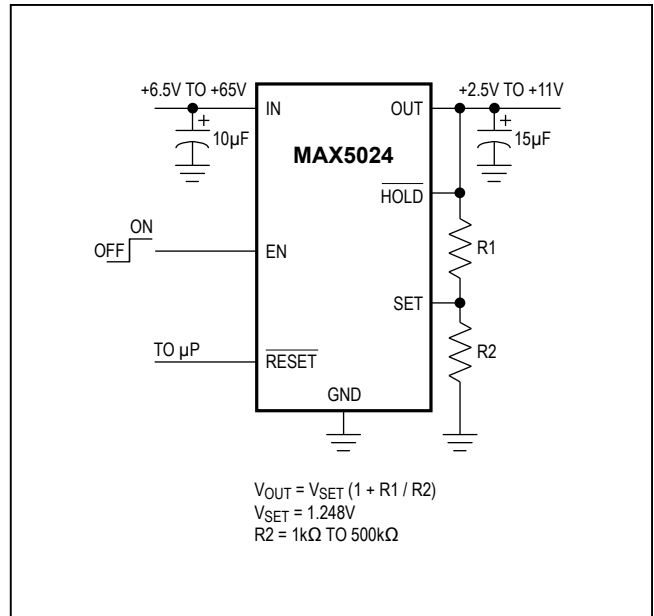

Figure 4. Setting the MAX5024 Adjustable Output Voltage

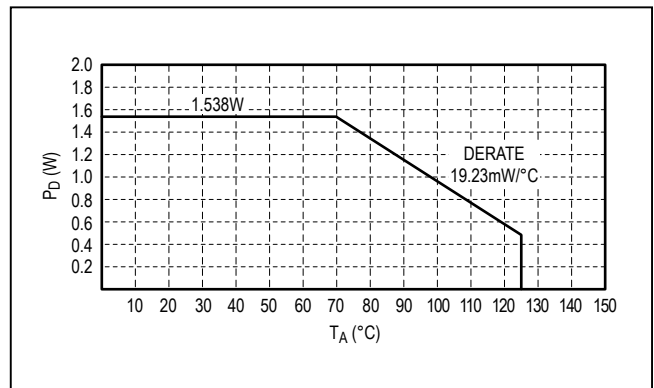

Figure 5. Maximum Power Dissipation vs. Temperature

After determining the allowable package dissipation, calculate the maximum output current using the following formula:

$$I_{OUT(MAX)} \cong \frac{P_D}{V_{IN} - V_{OUT}} \leq 150 \text{ mA}$$

The above equations do not include the negligible power dissipation from self-heating due to the IC ground current.

**Example 1:**

$$T_A = +95^\circ\text{C}$$

$$V_{IN} = +14\text{V}$$

$$V_{OUT} = +5\text{V}$$

Find the maximum allowable output current. First calculate package dissipation at the given temperature as follows:

$$P_D = 1.538\text{W} - (0.01923\text{W}/^\circ\text{C})(95^\circ\text{C} - 70^\circ\text{C}) = 1.057\text{W}$$

Then determine the maximum output current:

$$I_{OUT(MAX)} = \frac{(1.057\text{W})}{(14\text{V}) - (5\text{V})} = 117.4\text{mA}$$

**Example 2:**

$$T_A = +125^\circ\text{C}$$

$$V_{IN} = +14\text{V}$$

$$V_{OUT} = +3.3\text{V}$$

Calculate package dissipation at the given temperature as follows:

$$P_D = 1.538\text{W} - (0.01923\text{W}/^\circ\text{C})(125^\circ\text{C} - 70^\circ\text{C}) = 480.4\text{mW}$$

And establish the maximum current:

$$I_{OUT(MAX)} = \frac{(480.4\text{mW})}{(14\text{V}) - (3.3\text{V})} = 44.89\text{mA}$$

**Example 3:**

$$T_A = +50^\circ\text{C}$$

$$V_{IN} = +14\text{V}$$

$$V_{OUT} = +5\text{V}$$

Calculate package dissipation at the given temperature as follows:

$$P_D = 1.538\text{W}$$

And find the maximum output current:

$$I_{OUT(MAX)} = \frac{(1.538\text{W})}{(14\text{V}) - (5\text{V})} = 170.9\text{mA} \Rightarrow I_{OUT(MAX)} = 150\text{mA}$$

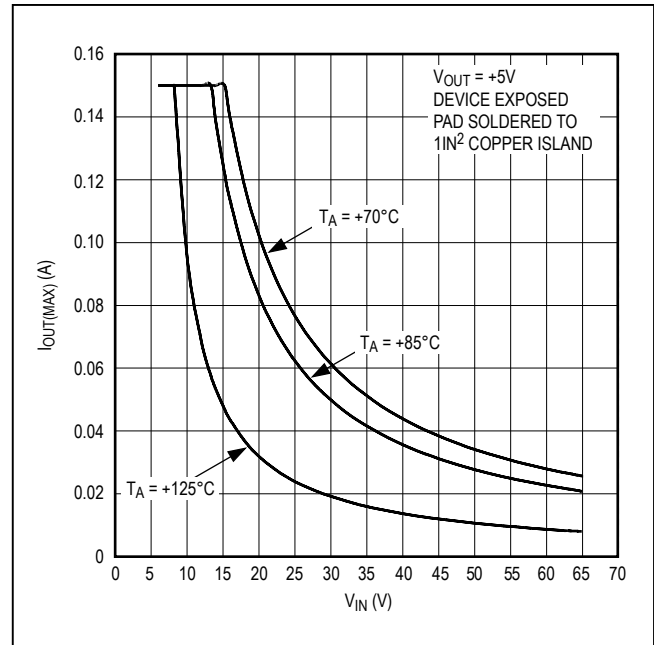

Figure 6. Maximum Output Current vs. Input Voltage

In Example 3, the maximum output current is calculated as 170.9mA, however, the maximum output current cannot exceed 150mA. Use Figure 6 to quickly determine allowable maximum output current for selected ambient temperatures.

**Capacitor Selection and Regulator Stability**

For stable operation over the full temperature range and with load currents up to 150mA, use a 15 $\mu$ F (min) output capacitor with an ESR < 0.5 $\Omega$ . To reduce noise and improve load-transient response, stability, and power-supply rejection, use larger output capacitor values such as 22 $\mu$ F.

Some ceramic dielectrics exhibit large capacitance and ESR variation with temperature. For dielectric capacitors such as Z5U and Y5V, use 22 $\mu$ F or more to ensure stability at temperatures below -10 $^\circ$ C. With X7R or X5R dielectrics, 15 $\mu$ F should be sufficient at all operating temperatures. For high-ESR tantalum capacitors use 22 $\mu$ F or more to maintain stability. To improve power-supply rejection and transient response use a minimum 10 $\mu$ F capacitor between IN and GND.

## Selector Guide

PART	PRESET $V_{OUT}$		RESET THRESHOLD ( $V_{TH}$ )				V <sub>OUT</sub> RESET TOLERANCE		WATCHDOG TIMER	ADJUSTABLE REGULATOR OUTPUT	/V
	5V	3.3V	4.63V	4.38V	3.05V	2.89V	$V_{OUT}$ - 7.5%	$V_{OUT}$ - 12.5%			
MAX5023L	✓	—	✓	—	—	—	✓	—	✓	—	—
MAX5023M	✓	—	—	✓	—	—	—	✓	✓	—	—
MAX5023T	—	✓	—	—	✓	—	✓	—	✓	—	—
MAX5023S	—	✓	—	—	—	✓	—	✓	✓	—	—
MAX5024L	✓	—	✓	—	—	—	✓	—	—	✓	—
MAX5024M	✓	—	—	✓	—	—	—	✓	—	✓	—
MAX5024T	—	✓	—	—	✓	—	✓	—	—	✓	—
MAX5024S	—	✓	—	—	—	✓	—	✓	—	✓	✓

## Ordering Information

PART	TEMP RANGE	PIN-PACKAGE
MAX5023_ASA	-40°C to +125°C	8 SO-EP*
MAX5023_ASA/V+**	-40°C to +125°C	8 SO-EP*
MAX5024_ASA	-40°C to +125°C	8 SO-EP*
MAX5024_ASA/V+	-40°C to +125°C	8 SO-EP*

**Note:** These parts offer a choice of reset thresholds, reset threshold tolerances, and regulator output voltages. From the Selector Guide, insert the desired suffix letter into the blank to complete the part number.

/V denotes an automotive qualified part.

+Denotes a lead(Pb)-free/RoHS-compliant package.

\*EP = Exposed pad.

\*\*Future product—contact factory for availability.

## Chip Information

PROCESS: BiCMOS

## Package Information

For the latest package outline information and land patterns (footprints), go to [www.maximintegrated.com/packages](http://www.maximintegrated.com/packages). Note that a "+", "#", or "-" in the package code indicates RoHS status only. Package drawings may show a different suffix character, but the drawing pertains to the package regardless of RoHS status.

PACKAGE TYPE	PACKAGE CODE	OUTLINE NO.	LAND PATTERN NO.
8L SOIC	S8E+14	<a href="#">21-0111</a>	<a href="#">90-0151</a>

## Revision History

REVISION NUMBER	REVISION DATE	DESCRIPTION	PAGES CHANGED
3	5/14	No IV OPNs; removed automotive reference from <i>Applications</i> section	1
4	3/15	Added IV OPNs to <i>Ordering Information</i> and updated Selector Guide; added Automotive to <i>Applications</i> section; renumbered notes in <i>Electrical Characteristics</i> section; moved <i>Ordering Information</i> , <i>Pin Configurations</i> , and <i>Typical Operating Circuit</i>	1–4, 8, 13
5	5/15	Changed WDI Pulse Width in <i>Electrical Characteristics</i> table from 50ns (min) to 50ns (typ); updated package code in <i>Package Information</i> section	4, 14
6	5/15	Updated junction-to-ambient thermal resistance in <i>Package Thermal Characteristics</i> section	2
7	8/15	Changed MAX5023_ASA/V+ to future product in <i>Ordering Information</i>	14
8	3/16	Updated package type in <i>Package Information</i> section	14

For pricing, delivery, and ordering information, please contact Maxim Direct at 1-888-629-4642, or visit Maxim Integrated's website at [www.maximintegrated.com](http://www.maximintegrated.com).

Maxim Integrated cannot assume responsibility for use of any circuitry other than circuitry entirely embodied in a Maxim Integrated product. No circuit patent licenses are implied. Maxim Integrated reserves the right to change the circuitry and specifications without notice at any time. The parametric values (min and max limits) shown in the *Electrical Characteristics* table are guaranteed. Other parametric values quoted in this data sheet are provided for guidance.

## Looking for pricing, stock, or lifecycle information?

Click below to explore more details on WIN SOURCE:

- ⊖ [View MAX5023SASA+ on WIN SOURCE](#)
- ⊖ [Maxim Integrated Information](#)

## Optimize Your Supply Chain with WIN SOURCE Solutions

- ✓ Global Sourcing Solution
- ✓ Obsolete Management
- ✓ Cost Control Management
- ✓ Shortage Management
- ✓ Alternative Solution
- ✓ Excess Inventory Management