



**THE DATASHEET OF
MAX6033CAUT25-T**



Click [here](#) for production status of specific part numbers.

MAX6033

High-Precision, Low-Dropout SOT23 Series Voltage Reference

General Description

The MAX6033 ultra-high-precision series voltage reference features a low 7ppm/°C (max) temperature coefficient and a low dropout voltage (200mV, max). Low temperature drift and low noise make the MAX6033 ideal for use with high-resolution ADCs or DACs.

- This device uses bandgap technology for low-noise performance and excellent accuracy. Laser-trimmed, high-stability, thin-film resistors, and postpackage trimming guarantee excellent initial accuracy ($\pm 0.04\%$, max). The MAX6033 consumes only 40 μ A of supply current and sources up to 15mA. Series mode references save system power and use minimal external components compared to two-terminal shunt references.
- The MAX6033 is available in the miniature 6-pin SOT23 package and is offered over the automotive temperature range (-40°C to +125°C).

Applications

- Precision Regulators
- A/D and D/A Converters
- Power Supplies
- Hard-Disk Drives
- High-Accuracy Industrial and Process Control
- Hand-Held Instruments

Typical Operating Circuit appears at end of data sheet.

Ordering Information/Selector Guide

PART	OUTPUT VOLTAGE (V)	TEMP COEFF (PPM/°C)	INITIAL ACCURACY (%)	TOP MARK
MAX6033AAUT25-T	2.500	10	0.04	ABDF
MAX6033BAUT25+T*	2.500	15	0.20	+AAXL
MAX6033AAUT25#TG16	2.500	10	0.04	#ACNC
MAX6033BAUT25-T	2.500	15	0.20	AAXL
MAX6033BAUT25#TG16	2.500	15	0.20	#ACND
MAX6033CAUT25-T	2.500	40	0.10	AAXH
MAX6033CAUT25+T*	2.500	40	0.10	+AAXH
MAX6033CAUT25#TG16	2.500	40	0.10	#ACNE

Ordering Information/Selector Guide continued on last page.

#Denotes a RoHS-compliant device that may include lead(Pb) that is exempt under the RoHS requirements.

T = Tape and reel.

*Denote as a future part.

Benefits and Features

- Stable Performance Over Temperature and Time Improves Accuracy
 - Ultra-Low Temperature Drift: 7ppm/°C (max)
 - $\pm 0.04\%$ Initial Accuracy
 - Stable with Capacitive Loads up to 100 μ F
 - Low 16 μ V_{p-p} Noise (0.1Hz to 10Hz) (2.5V Output)
 - Low 200mV Dropout Voltage
 - Excellent Load Regulation: 0.001mV/mA
- Low 40 μ A Quiescent Current Reduces System Power Consumption
- 2.7V to 12.6V Supply Voltage Eases Power Requirements

Pin Configuration

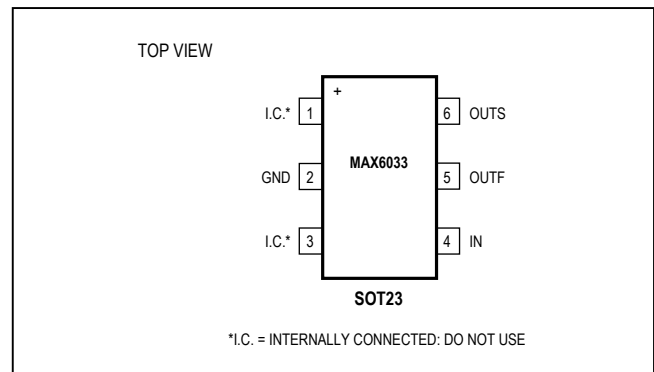

Absolute Maximum Ratings

IN to GND.....	-0.3V to +13V	Maximum Junction Temperature	+150°C
OUTF, OUTS to GND.....	-0.3V to +6V	Lead Temperature (soldering, 10s)	+300°C
Continuous Power Dissipation (TA = +70°C)		Soldering Temperature (reflow)	
6-Pin SOT23 (derate 7.40mW/°C above +70°C) ...	595.20mW	RoHS-Compliant Packages	+245°C
Operating Temperature Range.....	-40°C to +125°C	Packages Containing Lead(Pb).....	+240°C
Storage Temperature Range.....	-65°C to +150°C		

Stresses beyond those listed under "Absolute Maximum Ratings" may cause permanent damage to the device. These are stress ratings only, and functional operation of the device at these or any other conditions beyond those indicated in the operational sections of the specifications is not implied. Exposure to absolute maximum rating conditions for extended periods may affect device reliability.

Package Information

6 SOT23

PACKAGE CODE	U6F+6
Outline Number	21-0058
Land Pattern Number	90-0175
Thermal Resistance, Single-Layer Board	
Junction to Ambient (θ_{JA})	185.50
Junction to Case (θ_{JC})	75
Thermal Resistance, Four-Layer Board	
Junction to Ambient (θ_{JA})	134.40
Junction to Case (θ_{JC})	39

RoHS SOT23-6

PACKAGE CODE	U6FH+6
Outline Number	—
Land Pattern Number	—
Thermal Resistance, Single-Layer Board	
Junction to Ambient (θ_{JA})	185.50
Junction to Case (θ_{JC})	75
Thermal Resistance, Four-Layer Board	
Junction to Ambient (θ_{JA})	134.40
Junction to Case (θ_{JC})	39

For the latest package outline information and land patterns (footprints), go to www.maximintegrated.com/packages. Note that a "+", "#", or "-" in the package code indicates RoHS status only. Package drawings may show a different suffix character, but the drawing pertains to the package regardless of RoHS status.

Package thermal resistances were obtained using the method described in JEDEC specification JESD51-7, using a four-layer board. For detailed information on package thermal considerations, refer to www.maximintegrated.com/thermal-tutorial.

Electrical Characteristics— $V_{OUT} = 2.500V$ $(V_{IN} = 5V, C_{OUT} = 0.1\mu F, I_{OUT} = 0A, T_A = T_{MIN}$ to T_{MAX} , unless otherwise specified. Typical values are at $T_A = +25^\circ C$.) (Note 1)

PARAMETER	SYMBOL	CONDITIONS		MIN	TYP	MAX	UNITS
Output Voltage	V_{OUT}	$T_A = +25^\circ C$	MAX6033A	2.4990	2.5000	2.5010	V
			MAX6033B	2.4950	2.5000	2.5050	
			MAX6033C	2.4975	2.5000	2.5025	
Output-Voltage Accuracy		$T_A = +25^\circ C$	MAX6033A	-0.04		+0.04	%
			MAX6033B	-0.2		+0.2	
			MAX6033C	-0.1		+0.1	
Output Voltage Temperature Coefficient	TCV_{OUT}	MAX6033A	$T_A = -40^\circ C$ to $+85^\circ C$		1.5	7	ppm/ $^\circ C$
			$T_A = -40^\circ C$ to $+125^\circ C$		2.5	10	
		MAX6033B	$T_A = -40^\circ C$ to $+85^\circ C$		3	10	
			$T_A = -40^\circ C$ to $+125^\circ C$		7	15	
		MAX6033C	$T_A = -40^\circ C$ to $+85^\circ C$		6	20	
			$T_A = -40^\circ C$ to $+125^\circ C$		10	40	
Input Voltage Range	V_{IN}	Inferred from line regulation specification		2.7		12.6	V
Line Regulation	$\frac{\Delta V_{OUT}}{\Delta V_{IN}}$	$2.7V \leq V_{IN} \leq 12.6V$	$T_A = +25^\circ C$		3	25	$\mu V/V$
			$T_A = -40^\circ C$ to $+125^\circ C$			50	
Load Regulation	$\frac{\Delta V_{OUT}}{\Delta I_{OUT}}$	$-100\mu A \leq I_{OUT} \leq 15mA$	$T_A = +25^\circ C$		0.001	0.05	mV/mA
			$T_A = -40^\circ C$ to $+125^\circ C$			0.1	
Dropout Voltage (Note 2)	V_{DO}	$V_{OUT} = 0.1\%$, $I_{OUT} = 10mA$	$V_{OUT} = 0.1\%$, $I_{OUT} = 1mA$		0.02	0.2	V
			$T_A = -40^\circ C$ to $+85^\circ C$		0.3	0.4	
				$T_A = -40^\circ C$ to $+125^\circ C$			
Quiescent Supply Current	I_{IN}		$T_A = +25^\circ C$		40	60	μA
			$T_A = -40^\circ C$ to $+85^\circ C$			75	
			$T_A = -40^\circ C$ to $+125^\circ C$			85	
Output Short-Circuit Current	I_{SC}		$V_{OUT} = 0V$		90		mA
			$V_{OUT} = V_{IN}$		-2		
Output-Voltage Noise	en		$0.1Hz \leq f \leq 10Hz$		16		μV_{P-P}
			$10Hz \leq f \leq 1kHz$		12		μV_{RMS}
Turn-On Settling Time	t_{ON}		V_{OUT} settles to $\pm 0.01\%$ of final value		500		μs
Temperature Hysteresis			(Note 3)		150		ppm
Long-Term Stability			$\Delta t = 1000hr$		40		ppm

Electrical Characteristics— $V_{OUT} = 3.000V$ $(V_{IN} = 5V, C_{OUT} = 0.1\mu F, I_{OUT} = 0A, T_A = T_{MIN}$ to T_{MAX} , unless otherwise specified. Typical values are at $T_A = +25^\circ C$.) (Note 1)

PARAMETER	SYMBOL	CONDITIONS		MIN	TYP	MAX	UNITS
Output Voltage	V_{OUT}	$T_A = +25^\circ C$	MAX6033A	2.9988	3.0000	3.0012	V
			MAX6033B	2.9940	3.0000	3.0060	
			MAX6033C	2.9970	3.0000	3.0030	
Output-Voltage Accuracy		$T_A = +25^\circ C$	MAX6033A	-0.04		+0.04	%
			MAX6033B	-0.2		+0.2	
			MAX6033C	-0.1		+0.1	
Output-Voltage Temperature Coefficient	TCV_{OUT}	MAX6033A	$T_A = -40^\circ C$ to $+85^\circ C$		1.5	7	ppm/ $^\circ C$
			$T_A = -40^\circ C$ to $+125^\circ C$		2.5	10	
		MAX6033B	$T_A = -40^\circ C$ to $+85^\circ C$		3	10	
			$T_A = -40^\circ C$ to $+125^\circ C$		7	15	
		MAX6033C	$T_A = -40^\circ C$ to $+85^\circ C$		6	20	
$T_A = -40^\circ C$ to $+125^\circ C$		10	40				
Input Voltage Range	V_{IN}	Inferred from line regulation specification		3.2		12.6	V
Line Regulation	$\frac{\Delta V_{OUT}}{\Delta V_{IN}}$	$3.2V \leq V_{IN} \leq 12.6V$	$T_A = +25^\circ C$		4	30	$\mu V/V$
			$T_A = -40^\circ C$ to $+125^\circ C$			60	
Load Regulation	$\frac{\Delta V_{OUT}}{\Delta I_{OUT}}$	$-100\mu A \leq I_{OUT} \leq 15mA$	$T_A = +25^\circ C$		0.002	0.06	mV/mA
			$T_A = -40^\circ C$ to $+125^\circ C$			0.12	
Dropout Voltage (Note 2)	V_{DO}	$\Delta V_{OUT} = 0.1\%$	$I_{OUT} = 1mA$		0.02	0.2	V
			$I_{OUT} = 10mA$		0.2	0.4	
Quiescent Supply Current	I_{IN}	$T_A = +25^\circ C$			40	60	μA
		$T_A = -40^\circ C$ to $+85^\circ C$				75	
		$T_A = -40^\circ C$ to $+125^\circ C$					
Output Short-Circuit Current	I_{SC}	$V_{OUT} = 0V$			90		mA
		$V_{OUT} = V_{IN}$			-2		
Output-Voltage Noise	en	$0.1Hz \leq f \leq 10Hz$			24		μV_{P-P}
		$10Hz \leq f \leq 1kHz$			15		μV_{RMS}
Turn-On Settling Time	t_{ON}	V_{OUT} settles to $\pm 0.01\%$ of final value			600		μs
Temperature Hysteresis		(Note 3)			150		ppm
Long-Term Stability		$\Delta t = 1000hr$			40		ppm

Electrical Characteristics— $V_{OUT} = 4.096V$ (V_{IN} = 5V, C_{OUT} = 0.1μF, I_{OUT} = 0A, T_A = T_{MIN} to T_{MAX}, unless otherwise specified. Typical values are at T_A = +25°C.) (Note 1)

PARAMETER	SYMBOL	CONDITIONS		MIN	TYP	MAX	UNITS
Output Voltage	V _{OUT}	T _A = +25°C	MAX6033A	4.0943	4.0960	4.0977	V
			MAX6033B	4.0878	4.0960	4.1042	
			MAX6033C	4.0919	4.0960	4.1001	
Output-Voltage Accuracy		T _A = +25°C	MAX6033A	-0.04		+0.04	%
			MAX6033B	-0.2		+0.2	
			MAX6033C	-0.1		+0.1	
Output-Voltage Temperature Coefficient	TCV _{OUT}	MAX6033A	T _A = -40°C to +85°C		1.5	7	ppm/°C
			T _A = -40°C to +125°C		2.5	10	
		MAX6033B	T _A = -40°C to +85°C		3	10	
			T _A = -40°C to +125°C		7	15	
		MAX6033C	T _A = -40°C to +85°C		6	20	
			T _A = -40°C to +125°C		10	40	
Input-Voltage Range	V _{IN}	Inferred from line regulation specification		4.3		12.6	V
Line Regulation	$\frac{\Delta V_{OUT}}{\Delta V_{IN}}$	4.3V ≤ V _{IN} ≤ 12.6V	T _A = +25°C		6	30	μV/V
			T _A = -40°C to +125°C			60	
Load Regulation	$\frac{\Delta V_{OUT}}{\Delta I_{OUT}}$	-100μA ≤ I _{OUT} ≤ 15mA	T _A = +25°C		0.002	0.08	mV/mA
			T _A = -40°C to +125°C			0.15	
Dropout Voltage (Note 2)	V _{DO}	ΔV _{OUT} = 0.1%	I _{OUT} = 1mA		0.02	0.2	V
			I _{OUT} = 10mA		0.2	0.4	
Quiescent Supply Current	I _{IN}	T _A = +25°C			40	60	μA
		T _A = -40°C to +85°C				75	
		T _A = -40°C to +125°C					
Output Short-Circuit Current	I _{SC}	V _{OUT} = 0V			90		mA
		V _{OUT} = V _{IN}			-2		
Output-Voltage Noise	e _n	0.1Hz ≤ f ≤ 10Hz			32		μV _{P-P}
		10Hz ≤ f ≤ 1kHz			22		μV _{RMS}
Turn-On Settling Time	t _{ON}	V _{OUT} settles to ±0.01% of final value			800		μs
Temperature Hysteresis		(Note 3)			150		ppm
Long-Term Stability		Δt = 1000hr			40		ppm

Electrical Characteristics— $V_{OUT} = 5.000V$ (V_{IN} = 5.5V, C_{OUT} = 0.1μF, I_{OUT} = 0A, T_A = T_{MIN} to T_{MAX}, unless otherwise specified. Typical values are at T_A = +25°C.) (Note 1)

PARAMETER	SYMBOL	CONDITIONS		MIN	TYP	MAX	UNITS
Output Voltage	V _{OUT}	T _A = +25°C	MAX6033A	4.9980	5.000	5.0020	V
			MAX6033B	4.9900	5.000	5.0100	
			MAX6033C	4.9950	5.000	5.0050	
Output-Voltage Accuracy		T _A = +25°C	MAX6033A	-0.04		+0.04	%
			MAX6033B	-0.2		+0.2	
			MAX6033C	-0.1		+0.1	
Output-Voltage Temperature Coefficient	TCV _{OUT}	MAX6033A	T _A = -40°C to +85°C		1.5	7	ppm/°C
			T _A = -40°C to +125°C		2.5	10	
		MAX6033B	T _A = -40°C to +85°C		3	10	
			T _A = -40°C to +125°C		7	15	
		MAX6033C	T _A = -40°C to +85°C		6	20	
			T _A = -40°C to +125°C		10	40	
Input Voltage Range	V _{IN}	Inferred from line regulation specification		5.2		12.6	V
Line Regulation	$\frac{\Delta V_{OUT}}{\Delta V_{IN}}$	5.2V ≤ V _{IN} ≤ 12.6V	T _A = +25°C		7	50	μV/V
			T _A = -40°C to +125°C			100	
Load Regulation	$\frac{\Delta V_{OUT}}{\Delta I_{OUT}}$	-100μA ≤ I _{OUT} ≤ 15mA	T _A = +25°C		0.003	0.1	mV/mA
			T _A = -40°C to +125°C			0.2	
Dropout Voltage (Note 2)	V _{DO}	ΔV _{OUT} = 0.1%	I _{OUT} = 1mA		0.02	0.2	V
			I _{OUT} = 10mA		0.2	0.4	
Quiescent Supply Current	I _{IN}	T _A = +25°C			40	60	μA
		T _A = -40°C to +85°C				75	
		T _A = -40°C to +125°C					
Output Short-Circuit Current	I _{SC}	V _{OUT} = 0V			90		mA
		V _{OUT} = V _{IN}			-2		
Output-Voltage Noise	en	0.1Hz ≤ f ≤ 10Hz			40		μV _{P-P}
		10Hz ≤ f ≤ 1kHz			26		μV _{RMS}
Turn-On Settling Time	t _{ON}	V _{OUT} settles to ±0.01% of final value			1000		μs
Temperature Hysteresis		(Note 3)			150		ppm
Long-Term Stability		Δt = 1000hr			40		ppm

Note 1: MAX6033 is 100% production tested at T_A = +25°C and is guaranteed by design for T_A = T_{MIN} to T_{MAX} as specified.Note 2: Dropout Voltage is the minimum input voltage at which V_{OUT} changes ≤ 0.1% from V_{OUT} at V_{IN} = 5V (V_{IN} = 5.5V to V_{OUT} = 5V).Note 3: Temperature Hysteresis is defined as the change in +25°C output voltage before and after cycling the device from T_{MAX} to T_{MIN}.

Typical Operating Characteristics

($V_{IN} = 5V$, $C_{OUT} = 0.1\mu F$, $I_{OUT} = 0A$, $T_A = +25^\circ C$, unless otherwise specified.) (Note 4)

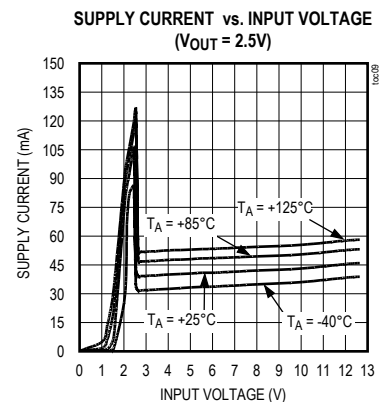
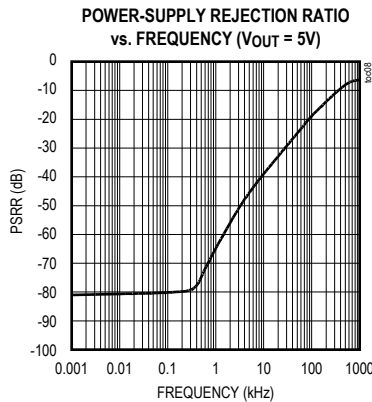
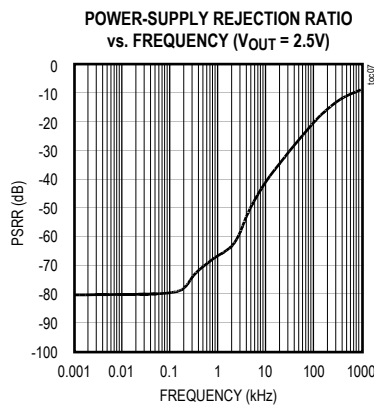
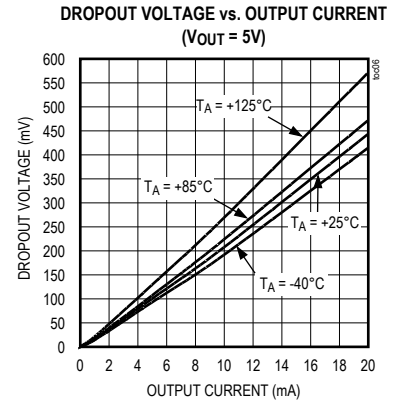
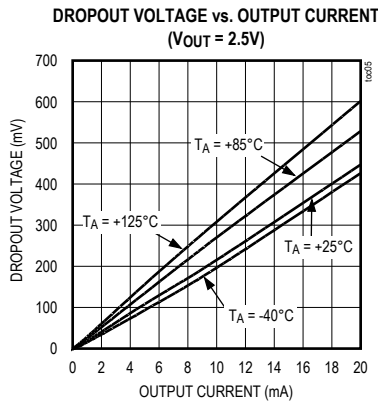
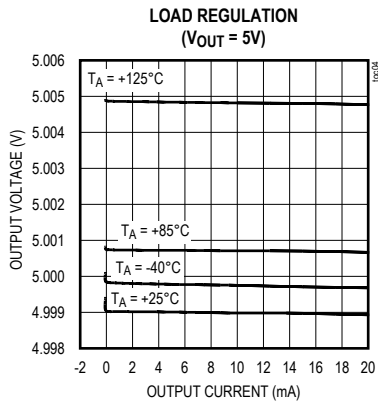
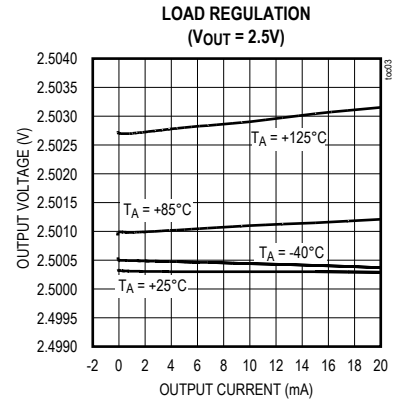
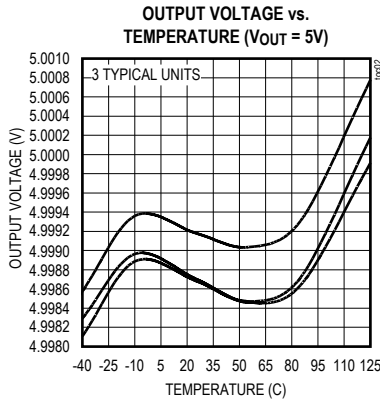
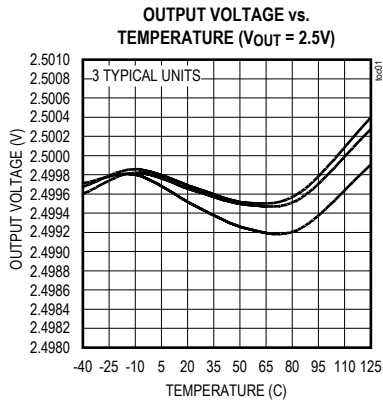

Typical Operating Characteristics (continued)

($V_{IN} = 5V$, $C_{OUT} = 0.1\mu F$, $I_{OUT} = 0A$, $T_A = +25^\circ C$, unless otherwise specified.) (Note 4)

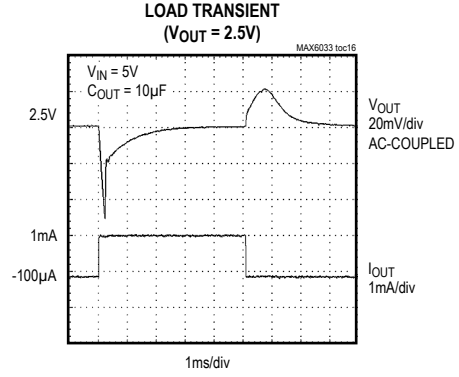
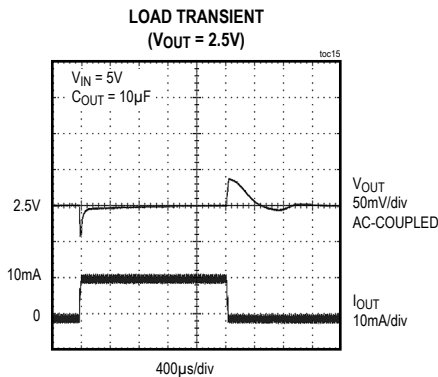
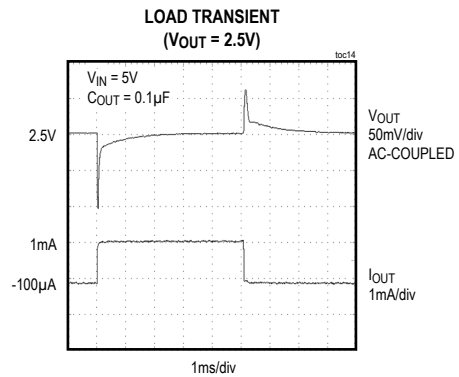
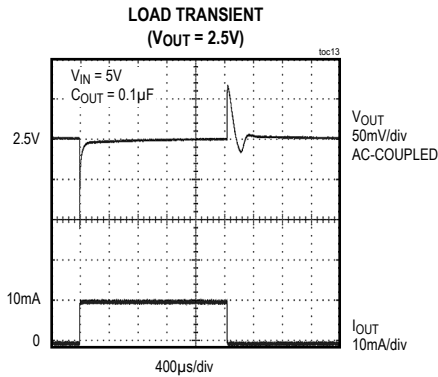
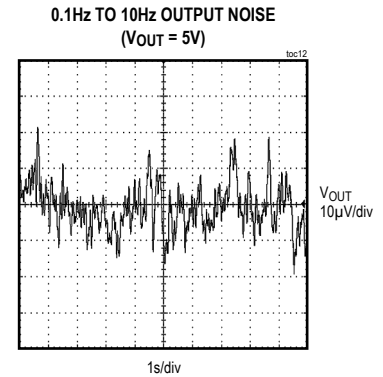
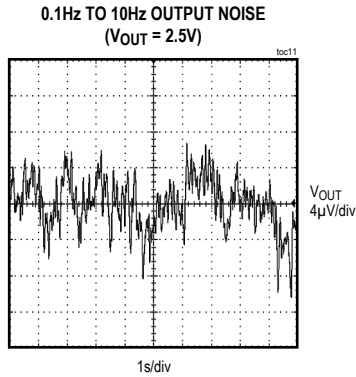
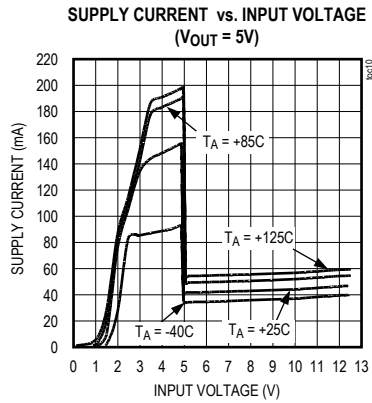

Typical Operating Characteristics (continued)

($V_{IN} = 5V$, $C_{OUT} = 0.1\mu F$, $I_{OUT} = 0A$, $T_A = +25^\circ C$, unless otherwise specified.) (Note 4)

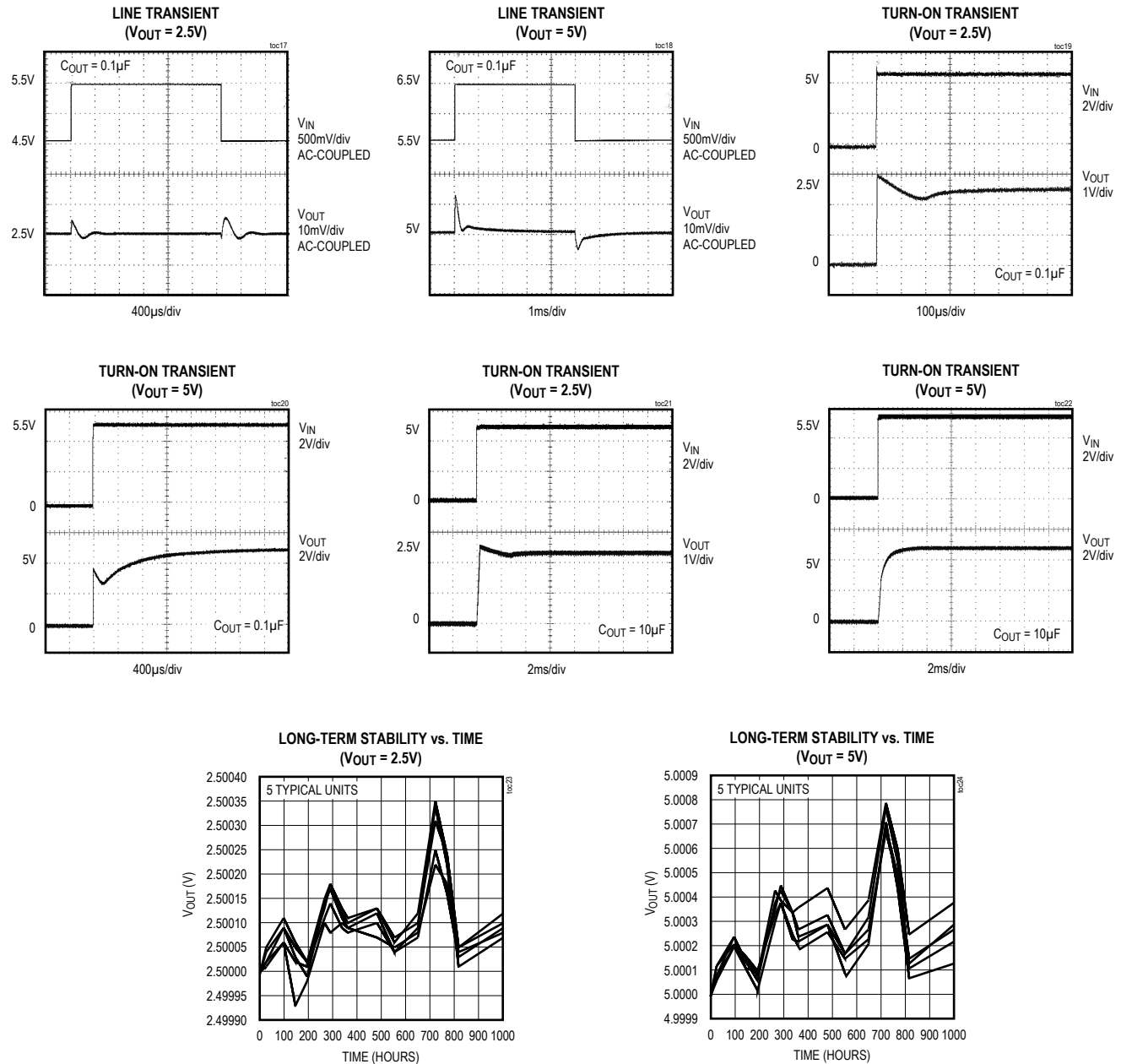

Note 4: Many of the MAX6033 Typical Operating Characteristics are similar. The extremes of these characteristics are found in the MAX6033 (2.5V output) and the MAX6033 (5V output). The Typical Operating Characteristics of the remainder of the MAX6033 family typically lie between these two extremes and can be estimated based on their output voltages.

Pin Description

PIN	NAME	FUNCTION
1, 3	I.C.	Internally Connected. Do not connect externally.
2	GND	Ground
4	IN	Positive Power-Supply Input
5	OUTF	Voltage Reference Force Output. Short OUTF to OUTS as close to the device as possible. Bypass OUTF with 0.1µF (min) capacitor to GND.
6	OUTS	Voltage Reference Sense

Applications Information

Bypassing/Load Capacitance

For the best line-transient performance, decouple the input with a 0.1µF ceramic capacitor as shown in the Typical Operating Circuit. Place the capacitor as close to IN as possible. When transient performance is less important, no capacitor is necessary.

The MAX6033 family requires a minimum output capacitance of 0.1µF for stability and is stable with capacitive loads (including the bypass capacitance) of up to 100µF. In applications where the load or the supply can experience step changes, a larger output capacitor reduces the amount of overshoot (undershoot) and improves the circuit's transient response. Place output capacitors as close to the device as possible.

Supply Current

The quiescent supply current of the MAX6033 series reference is typically 40µA and is virtually independent of the supply voltage. In the MAX6033 family, the load current is drawn from the input only when required, so supply current is not wasted and efficiency is maximized at all input voltages. This improved efficiency reduces power dissipation and extends battery life.

When the supply voltage is below the minimum-specified input voltage (as during turn-on), the devices can draw up to 150µA beyond the nominal supply current. The input voltage source must be capable of providing this current to ensure reliable turn-on.

Output-Voltage Hysteresis

Output voltage hysteresis is the change in the output voltage at $T_A = +25^\circ\text{C}$ before and after the device is cycled over its entire operating temperature range. Hysteresis is caused by differential package stress appearing across

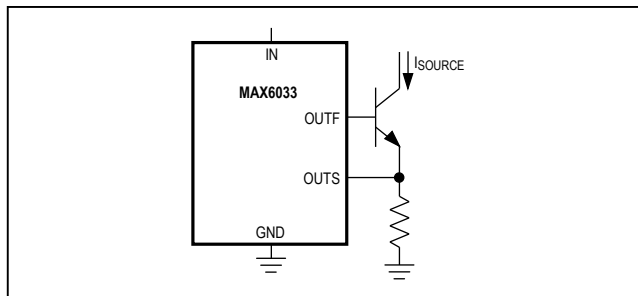

Figure 1. Precision Current Source

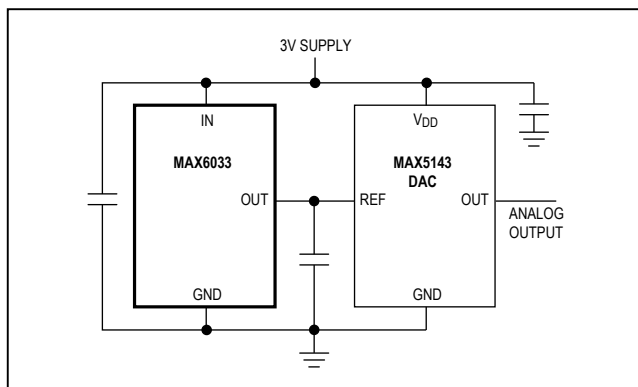

Figure 2. 14-Bit High-Resolution DAC and Positive Reference from a Single 3V Supply

the bandgap core transistors. The typical temperature hysteresis value is 150ppm.

Turn-On Time

These devices typically turn on and settle to within 0.01% of their final value in $>1\mu\text{s}$. The turn-on time can increase up to 2ms with the device operating at the minimum drop-out voltage and the maximum load.

Precision Current Source

Figure 1 shows a typical circuit providing a precision current source. The OUTF output provides the bias current for the bipolar transistor. OUTS senses the voltage across the resistor and adjusts the current sourced by OUTF accordingly.

High-Resolution DAC and Reference from Single Supply

Figure 2 shows a typical circuit providing both the power supply and reference for a high-resolution DAC. A MAX6033 with 2.5V output provides the reference voltage for the DAC.

Ordering Information/Selector Guide (continued)

PART	OUTPUT VOLTAGE (V)	TEMP COEFF (PPM/°C)	INITIAL ACCURACY (%)	TOP MARK
MAX6033AAUT30-T	3.000	10	0.04	ABDG
MAX6033BAUT30+T*	3.000	15	0.20	+AAXM
MAX6033AAUT30#TG16	3.000	10	0.04	#ACNF
MAX6033BAUT30-T	3.000	15	0.20	AAXM
MAX6033BAUT30+T*	3.000	15	0.20	+AAXM
MAX6033BAUT30#TG16	3.000	15	0.20	#ACNG
MAX6033CAUT30-T	3.000	40	0.10	AAXI
MAX6033CAUT30+T*	3.000	40	0.10	-
MAX6033CAUT30#TG16	3.000	40	0.10	#ACNH
MAX6033AAUT41-T	4.096	10	0.04	ABDH
MAX6033BAUT41+T*	4.096	15	0.20	-
MAX6033AAUT41#TG16	4.096	10	0.04	#ACNI
MAX6033BAUT41-T	4.096	15	0.20	AAXN
MAX6033BAUT41#TG16	4.096	15	0.20	#ACLG
MAX6033CAUT41-T	4.096	40	0.10	AAXJ
MAX6033CAUT41+T*	4.096	40	0.10	-
MAX6033CAUT41#TG16	4.096	40	0.10	#ACNJ
MAX6033AAUT50-T	5.000	10	0.04	ABDI
MAX6033BAUT50+T*	5.000	15	0.20	-
MAX6033AAUT50#TG16	5.000	10	0.04	#ACNK
MAX6033BAUT50-T	5.000	15	0.20	AAXO
MAX6033BAUT50#TG16	5.000	15	0.20	#ACNL
MAX6033CAUT50-T	5.000	40	0.10	AAXK
MAX6033CAUT50+T*	5.000	40	0.10	+AAXK
MAX6033CAUT50#TG16	5.000	40	0.10	#ACNM

#Denotes a RoHS-compliant device that may include lead(Pb) that is exempt under the RoHS requirements.

T = Tape and reel.

Typical Operating Circuit

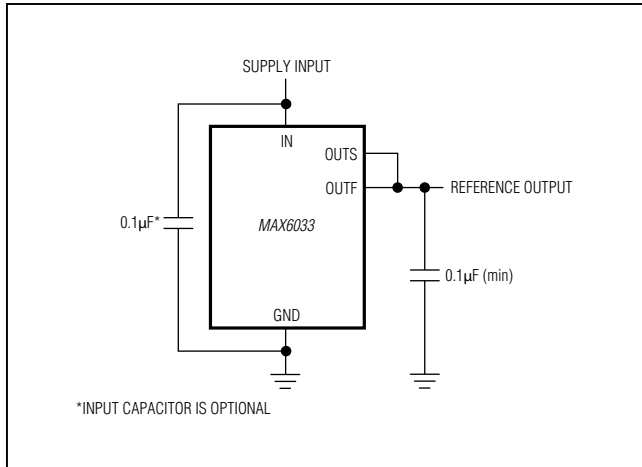

Chip Information

PROCESS: BiCMOS

Revision History

REVISION NUMBER	REVISION DATE	DESCRIPTION	PAGES CHANGED
2	6/03	Various changes	—
3	3/12	Replaced <i>Ordering Information</i> table/Selector Guide, updated packaging information	1, 10
4	2/19	Updated <i>Ordering Information</i> , <i>Absolute Maximum Ratings</i> , and <i>Package Thermal Characteristics</i>	1, 2, 10

For pricing, delivery, and ordering information, please visit Maxim Integrated's online storefront at <https://www.maximintegrated.com/en/storefront/storefront.html>.

Maxim Integrated cannot assume responsibility for use of any circuitry other than circuitry entirely embodied in a Maxim Integrated product. No circuit patent licenses are implied. Maxim Integrated reserves the right to change the circuitry and specifications without notice at any time. The parametric values (min and max limits) shown in the *Electrical Characteristics* table are guaranteed. Other parametric values quoted in this data sheet are provided for guidance.

Looking for pricing, stock, or lifecycle information?

Click below to explore more details on WIN SOURCE:

- ⊖ [View MAX6033CAUT25-T on WIN SOURCE](#)
- ⊖ [Maxim Integrated Information](#)

Optimize Your Supply Chain with WIN SOURCE Solutions

- ✓ Global Sourcing Solution
- ✓ Obsolete Management
- ✓ Cost Control Management
- ✓ Shortage Management
- ✓ Alternative Solution
- ✓ Excess Inventory Management