



**THE DATASHEET OF  
MAX6314US26D4+T**





# 68HC11/Bidirectional-Compatible $\mu$ P Reset Circuit

MAX6314

## General Description

The MAX6314 low-power CMOS microprocessor ( $\mu$ P) supervisory circuit is designed to monitor power supplies in  $\mu$ P and digital systems. The MAX6314's  $\overline{\text{RESET}}$  output is bidirectional, allowing it to be directly connected to  $\mu$ Ps with bidirectional reset inputs, such as the 68HC11. It provides excellent circuit reliability and low cost by eliminating external components and adjustments. The MAX6314 also provides a debounced manual reset input.

This device performs a single function: it asserts a reset signal whenever the  $V_{CC}$  supply voltage falls below a preset threshold or whenever manual reset is asserted. Reset remains asserted for an internally programmed interval (reset timeout period) after  $V_{CC}$  has risen above the reset threshold or manual reset is deasserted.

The MAX6314 comes with factory-trimmed reset threshold voltages in 100mV increments from 2.5V to 5V. Preset timeout periods of 1ms, 20ms, 140ms, and 1120ms (minimum) are also available. The device comes in a SOT143 package.

For a  $\mu$ P supervisor with an open-drain reset pin, see the MAX6315 data sheet.

## Applications

- Computers
- Controllers
- Intelligent Instruments
- Critical  $\mu$ P and  $\mu$ C Power Monitoring
- Portable/Battery-Powered Equipment

## Typical Operating Circuit

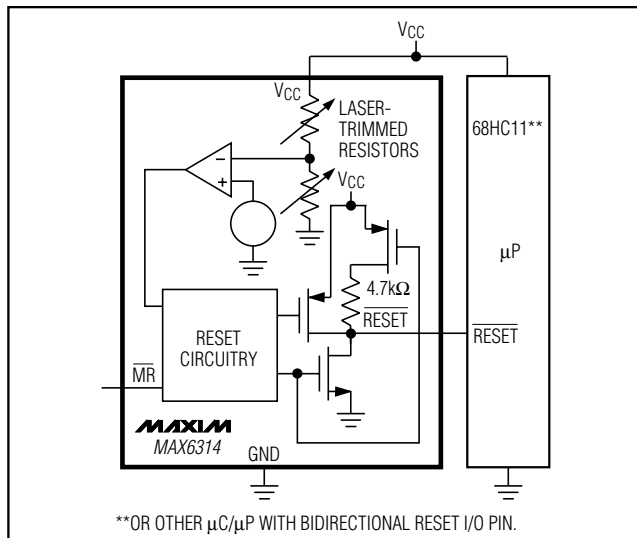

## Features

- ◆ Small SOT143 Package
- ◆  $\overline{\text{RESET}}$  Output Simplifies Interface to Bidirectional Reset I/Os
- ◆ Precision Factory-Set  $V_{CC}$  Reset Thresholds: 100mV Increments from 2.5V to 5V
- ◆  $\pm 1.8\%$  Reset Threshold Accuracy at  $T_A = +25^\circ\text{C}$
- ◆  $\pm 2.5\%$  Reset Threshold Accuracy Over Temp.
- ◆ Four Reset Timeout Periods Available: 1ms, 20ms, 140ms, or 1120ms (minimum)
- ◆ Immune to Short  $V_{CC}$  Transients
- ◆ 5 $\mu$ A Supply Current
- ◆ Pin-Compatible with MAX811

## Ordering Information

PART <sup>†</sup>	NOMINAL $V_{TH}$ (V)	MIN $t_{RP}$ (ms)	TOP MARK <sup>††</sup>
MAX6314US50D1-T	5.00	1	AA_ _
MAX6314US49D1-T	4.90	1	AB_ _
MAX6314US48D1-T	4.80	1	AC_ _
MAX6314US47D1-T	4.70	1	AD_ _
MAX6314US46D1-T	4.63	1	AE_ _
MAX6314US45D1-T	4.50	1	AF_ _

<sup>†</sup>The MAX6314 is available in a SOT143 package,  $-40^\circ\text{C}$  to  $+85^\circ\text{C}$  temperature range.

<sup>††</sup>The first two letters in the package top mark identify the part, while the remaining two letters are the lot tracking code.

Devices are available in both leaded and lead-free packaging. Specify lead-free by replacing "-T" with "+T" when ordering.

Ordering Information continued at end of data sheet.

## Pin Configuration



**For pricing, delivery, and ordering information, please contact Maxim/Dallas Direct! at 1-888-629-4642, or visit Maxim's website at [www.maxim-ic.com](http://www.maxim-ic.com).**

# 68HC11/Bidirectional-Compatible μP Reset Circuit

## ABSOLUTE MAXIMUM RATINGS

V <sub>CC</sub> .....	-0.3V to +6.0V
All Other Pins .....	-0.3V to (V <sub>CC</sub> + 0.3V)
Input Current (V <sub>CC</sub> ) .....	20mA
Output Current (RESET) .....	20mA
Rate of Rise (V <sub>CC</sub> ) .....	100V/μs

Continuous Power Dissipation (T <sub>A</sub> = +70°C) SOT143 (derate 4mW/°C above +70°C) .....	320mW
Operating Temperature Range .....	-40°C to +85°C
Storage Temperature Range .....	-65°C to +160°C
Lead Temperature (soldering, 10sec) .....	+300°C

Stresses beyond those listed under "Absolute Maximum Ratings" may cause permanent damage to the device. These are stress ratings only, and functional operation of the device at these or any other conditions beyond those indicated in the operational sections of the specifications is not implied. Exposure to absolute maximum rating conditions for extended periods may affect device reliability.

## ELECTRICAL CHARACTERISTICS

(V<sub>CC</sub> = +2.5V to +5.5V, T<sub>A</sub> = -40°C to +85°C, unless otherwise noted. Typical values are at T<sub>A</sub> = +25°C.)

PARAMETER	SYMBOL	CONDITIONS	MIN	TYP	MAX	UNITS
Operating Voltage Range	V <sub>CC</sub>	T <sub>A</sub> = 0°C to +70°C	1.0		5.5	V
V <sub>CC</sub> Supply Current	I <sub>CC</sub>	V <sub>CC</sub> = 5.5V, no load		5	12	μA
		V <sub>CC</sub> = 3.6V, no load		4	10	
Reset Threshold (Note 1)	V <sub>TH</sub>	T <sub>A</sub> = +25°C	V <sub>TH</sub> - 1.8%	V <sub>TH</sub>	V <sub>TH</sub> + 1.8%	V
		T <sub>A</sub> = -40°C to +85°C	V <sub>TH</sub> - 2.5%		V <sub>TH</sub> + 2.5%	
Reset Threshold Tempco	ΔV <sub>TH</sub> /°C			60		ppm/°C
V <sub>CC</sub> to Reset Delay		V <sub>CC</sub> = falling at 1mV/μs		35		μs
Reset Timeout Period	t <sub>RP</sub>	MAX6314US_ _D1-T	1	1.4	2	ms
		MAX6314US_ _D2-T	20	28	40	
		MAX6314US_ _D3-T	140	200	280	
		MAX6314US_ _D4-T	1120	1570	2240	
<b>MANUAL RESET INPUT</b>						
MR Input Threshold	V <sub>IL</sub>	V <sub>TH</sub> > 4.0V	0.8			V
	V <sub>IH</sub>		2.4			
	V <sub>IL</sub>	V <sub>TH</sub> < 4.0V	0.3 × V <sub>CC</sub>			
	V <sub>IH</sub>		0.7 × V <sub>CC</sub>			
MR Minimum Input Pulse			1			μs
MR Glitch Rejection				100		ns
MR to Reset Delay				500		ns
MR Pullup Resistance			32	63	100	kΩ
RESET Output Voltage	V <sub>OL</sub>	V <sub>CC</sub> > 4.25V, I <sub>SINK</sub> = 3.2mA			0.4	V
		V <sub>CC</sub> > 2.5V, I <sub>SINK</sub> = 1.2mA			0.3	
		V <sub>CC</sub> > 1.2V, I <sub>SINK</sub> = 0.5mA			0.3	
		V <sub>CC</sub> > 1.0V, I <sub>SINK</sub> = 80μA			0.3	
<b>RESET INTERNAL PULLUP</b>						
Transition Flip-Flop Setup Time (Note 2)	t <sub>S</sub>			400		ns
Active Pullup Enable Threshold		V <sub>CC</sub> = 5V	0.4		0.9	V
RESET Active Pullup Current		V <sub>CC</sub> = 5V		20		mA
RESET Pullup Resistance			4.2	4.7	5.2	kΩ
RESET Output Rise Time (Note 3)	t <sub>R</sub>	V <sub>CC</sub> = 3V	C <sub>LOAD</sub> = 120pF		333	ns
			C <sub>LOAD</sub> = 250pF		666	
		V <sub>CC</sub> = 5V	C <sub>LOAD</sub> = 200pF		333	
			C <sub>LOAD</sub> = 400pF		666	

**Note 1:** The MAX6314 monitors V<sub>CC</sub> through an internal, factory-trimmed voltage divider that programs the nominal reset threshold. Factory-trimmed reset thresholds are available in 100mV increments from 2.5V to 5V (see *Ordering and Marking Information*).

**Note 2:** This is the minimum time RESET must be held low by an external pull-down source to set the active pull-up flip-flop.

**Note 3:** Measured from RESET V<sub>OL</sub> to (0.8 × V<sub>CC</sub>), R<sub>LOAD</sub> = ∞.

# 68HC11/Bidirectional-Compatible $\mu$ P Reset Circuit

## Typical Operating Characteristics

( $T_A = +25^\circ\text{C}$ , unless otherwise noted.)

MAX6314

**PULLUP CHARACTERISTICS**



4.7k $\Omega$  PULL-UP  
2V/div

MAX6314 PULL-UP  
2V/div

INPUT  
5V/div

200ns/div

**SUPPLY CURRENT vs. TEMPERATURE**

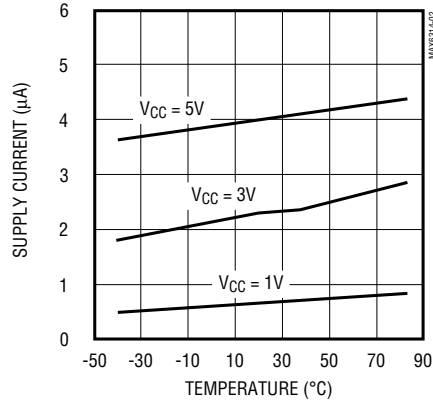

**SUPPLY CURRENT vs. SUPPLY VOLTAGE**



**POWER-DOWN RESET DELAY vs. TEMPERATURE**



**NORMALIZED RESET TIMEOUT PERIOD vs. TEMPERATURE (VCC RISING)**

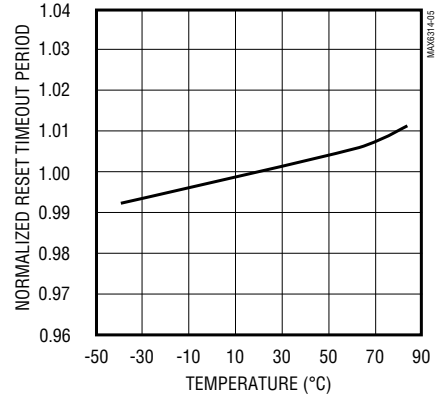

**NORMALIZED RESET THRESHOLD vs. TEMPERATURE (VCC FALLING)**

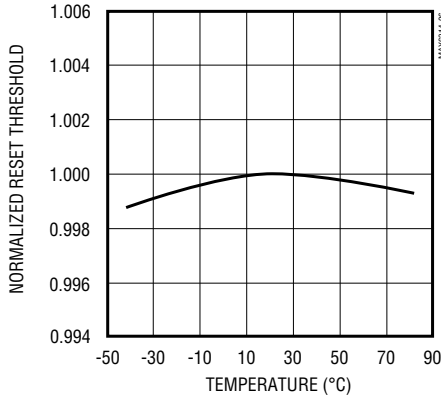

**MAXIMUM TRANSIENT DURATION vs. RESET COMP. OVERDRIVE**

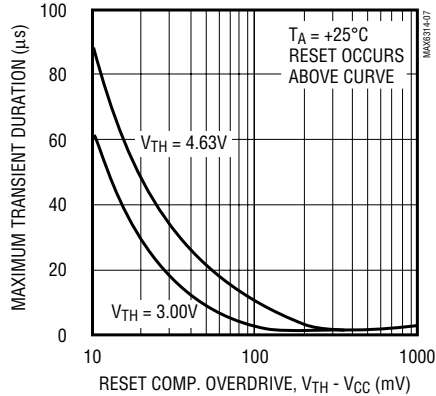

**RESET PULLUP TIME vs. TEMPERATURE**



# 68HC11/Bidirectional-Compatible $\mu$ P Reset Circuit

## Pin Description

PIN	NAME	FUNCTION
1	GND	Ground
2	$\overline{\text{RESET}}$	Active-Low Complementary Output. In addition to the normal n-channel pulldown, $\overline{\text{RESET}}$ has a p-channel pullup transistor in parallel with a 4.7k $\Omega$ resistor to facilitate connection to $\mu$ Ps with bidirectional resets. See the <i>Reset Output</i> section.
3	$\overline{\text{MR}}$	Manual Reset Input. A logic low on $\overline{\text{MR}}$ asserts reset. Reset remains asserted as long as $\overline{\text{MR}}$ is low, and for the reset timeout period ( $t_{RP}$ ) after the reset conditions are terminated. Connect to $V_{CC}$ if not used.
4	$V_{CC}$	Supply Voltage and Reset Threshold Monitor Input



Figure 1. Functional Diagram

# 68HC11/Bidirectional-Compatible $\mu$ P Reset Circuit

## Detailed Description

The MAX6314 has a reset output consisting of a 4.7k $\Omega$  pull-up resistor in parallel with a P-channel transistor and an N-channel pull down (Figure 1), allowing this IC to directly interface with microprocessors ( $\mu$ Ps) that have bidirectional reset pins (see the *Reset Output* section).

### Reset Output

A  $\mu$ P's reset input starts the  $\mu$ P in a known state. The MAX6314 asserts reset to prevent code-execution errors during power-up, power-down, or brownout conditions.  $\overline{\text{RESET}}$  is guaranteed to be a logic low for  $V_{CC} > 1\text{V}$  (see the *Electrical Characteristics* table). Once  $V_{CC}$  exceeds the reset threshold, the internal timer keeps reset asserted for the reset timeout period ( $t_{RP}$ ); after this interval  $\overline{\text{RESET}}$  goes high. If a brownout condition occurs (monitored voltage dips below its programmed reset threshold),  $\overline{\text{RESET}}$  goes low. Any time  $V_{CC}$  dips below the reset threshold, the internal timer resets to zero and  $\overline{\text{RESET}}$  goes low. The internal timer starts when  $V_{CC}$  returns above the reset threshold, and  $\overline{\text{RESET}}$  remains low for the reset timeout period.

The MAX6314's  $\overline{\text{RESET}}$  output is designed to interface with  $\mu$ Ps that have bidirectional reset pins, such as the Motorola 68HC11. Like an open-drain output, the MAX6314 allows the  $\mu$ P or other devices to pull  $\overline{\text{RESET}}$  low and assert a reset condition. However, unlike a standard open-drain output, it includes the commonly specified 4.7k $\Omega$  pullup resistor with a P-channel active pullup in parallel.

This configuration allows the MAX6314 to solve a problem associated with  $\mu$ Ps that have bidirectional reset pins in systems where several devices connect to  $\overline{\text{RESET}}$ . These  $\mu$ Ps can often determine if a reset was asserted by an external device (i.e., the supervisor IC) or by the  $\mu$ P itself (due to a watchdog fault, clock error, or other source), and then jump to a vector appropriate for the source of the reset. However, if the  $\mu$ P does assert reset, it does not retain the information, but must determine the cause after the reset has occurred.

The following procedure describes how this is done with the Motorola 68HC11. In all cases of reset, the  $\mu$ P pulls  $\overline{\text{RESET}}$  low for about four E-clock cycles. It then releases  $\overline{\text{RESET}}$ , waits for two E-clock cycles, then checks  $\overline{\text{RESET}}$ 's state. If  $\overline{\text{RESET}}$  is still low, the  $\mu$ P concludes that the source of the reset was external and, when  $\overline{\text{RESET}}$  eventually reaches the high state, jumps to the normal reset vector. In this case, stored state information is erased and processing begins from

scratch. If, on the other hand,  $\overline{\text{RESET}}$  is high after the two E-clock cycle delay, the processor knows that it caused the reset itself and can jump to a different vector and use stored state information to determine what caused the reset.

The problem occurs with faster  $\mu$ Ps; two E-clock cycles is only 500ns at 4MHz. When there are several devices on the reset line, the input capacitance and stray capacitance can prevent  $\overline{\text{RESET}}$  from reaching the logic-high state ( $0.8 \times V_{CC}$ ) in the allowed time if only a passive pullup resistor is used. In this case, all resets will be interpreted as external. The  $\mu$ P is guaranteed to sink only 1.6mA, so the rise time cannot be much reduced by decreasing the recommended 4.7k $\Omega$  pullup resistance.

The MAX6314 solves this problem by including a pullup transistor in parallel with the recommended 4.7k $\Omega$  resistor (Figure 1). The pullup resistor holds the output high until  $\overline{\text{RESET}}$  is forced low by the  $\mu$ P reset I/O, or by the MAX6314 itself. Once  $\overline{\text{RESET}}$  goes below 0.5V, a comparator sets the transition edge flip-flop, indicating that the next transition for  $\overline{\text{RESET}}$  will be low to high. As soon as  $\overline{\text{RESET}}$  is released, the 4.7k $\Omega$  resistor pulls  $\overline{\text{RESET}}$  up toward  $V_{CC}$ . When  $\overline{\text{RESET}}$  rises above 0.5V, the active p-channel pullup turns on for the 2 $\mu$ s duration of the one-shot. The parallel combination of the 4.7k $\Omega$  pullup and the p-channel transistor on-resistance quickly charges stray capacitance on the reset line, allowing  $\overline{\text{RESET}}$  to transition low to high within the required two E-clock period, even with several devices on the reset line (Figure 2). Once the one-shot times out, the p-channel transistor turns off. This process occurs regardless of whether the reset was caused by  $V_{CC}$  dipping below the reset threshold,  $\overline{\text{MR}}$  being asserted, or the  $\mu$ P or other device asserting  $\overline{\text{RESET}}$ . Because the MAX6314 includes the standard 4.7k $\Omega$  pullup resistor, no external pullup resistor is required. To minimize current consumption, the internal pullup resistor is disconnected whenever the MAX6314 asserts  $\overline{\text{RESET}}$ .

### Manual Reset Input

Many  $\mu$ P-based products require manual reset capability, allowing the operator, a test technician, or external logic circuitry to initiate a reset. A logic low on  $\overline{\text{MR}}$  asserts reset. Reset remains asserted while  $\overline{\text{MR}}$  is low, and for the reset active timeout period after  $\overline{\text{MR}}$  returns high. To minimize current consumption, the internal 4.7k $\Omega$  pullup resistor on  $\overline{\text{RESET}}$  is disconnected whenever  $\overline{\text{RESET}}$  is asserted.

# 68HC11/Bidirectional-Compatible $\mu$ P Reset Circuit

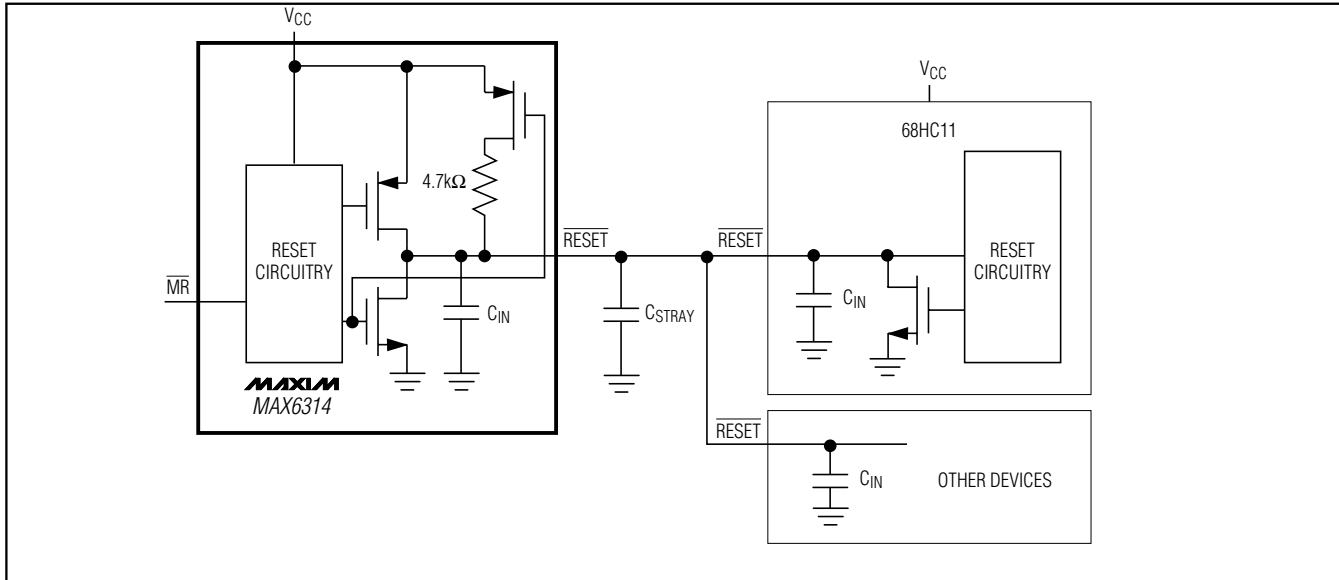

Figure 2. MAX6314 Supports Additional Devices on the Reset Bus

$\overline{\text{MR}}$  has an internal 63k $\Omega$  pullup resistor, so it can be left open if not used. Connect a normally open momentary switch from  $\overline{\text{MR}}$  to GND to create a manual reset function; external debounce circuitry is not required. If  $\overline{\text{MR}}$  is driven from long cables or if the device is used in a noisy environment, connecting a 0.1 $\mu\text{F}$  capacitor from  $\overline{\text{MR}}$  to ground provides additional noise immunity.

## Applications Information

### Negative-Going VCC Transients

In addition to issuing a reset to the  $\mu\text{P}$  during power-up, power-down, and brownout conditions, these devices are relatively immune to short-duration negative-going transients (glitches). The *Typical Operating Characteristics* show the Maximum Transient Duration vs. Reset Threshold Overdrive, for which reset pulses are not generated. The graph was produced using negative-going pulses, starting at  $V_{\text{RST max}}$  and ending below the programmed reset threshold by the magnitude indicated (reset threshold overdrive). The graph shows the maximum pulse width that a negative-going VCC transient may typically have without causing a reset pulse to be issued. As the amplitude of the transient increases (i.e., goes farther below the reset threshold), the maximum allowable pulse width decreases. A 0.1 $\mu\text{F}$  bypass capacitor mounted close to VCC provides additional transient immunity.

### Ensuring a Valid $\overline{\text{RESET}}$ Output Down to VCC = 0V

When VCC falls below 1V,  $\overline{\text{RESET}}$  no longer sinks current—it becomes an open circuit. Therefore, high-impedance CMOS-logic inputs connected to  $\overline{\text{RESET}}$  can drift to undetermined voltages. This presents no problem in most applications, since most  $\mu\text{P}$  and other circuitry is inoperative with VCC below 1V. However, in applications where  $\overline{\text{RESET}}$  must be valid down to VCC = 0V, adding a pull-down resistor to  $\overline{\text{RESET}}$  will cause any stray leakage currents to flow to ground, holding  $\overline{\text{RESET}}$  low (Figure 3). R1's value is not critical; 100k $\Omega$  is large enough not to load  $\overline{\text{RESET}}$  and small enough to pull  $\overline{\text{RESET}}$  to ground.

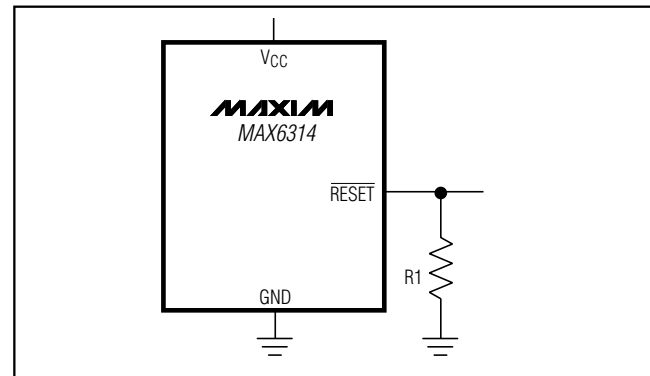

Figure 3.  $\overline{\text{RESET}}$  Valid to VCC = Ground Circuit

# 68HC11/Bidirectional-Compatible $\mu$ P Reset Circuit

MAX6314



Figure 4. RESET Timing Diagram

## Ordering Information (continued)

PART†	NOMINAL V <sub>TH</sub> (V)	MIN t <sub>RP</sub> (ms)	TOP MARK††
<b>MAX6314US44D1-T†††</b>	4.39	1	AG_ _
MAX6314US43D1-T	4.30	1	AH_ _
MAX6314US42D1-T	4.20	1	AI_ _
MAX6314US41D1-T	4.10	1	AJ_ _
MAX6314US40D1-T	4.00	1	AK_ _
MAX6314US39D1-T	3.90	1	AL_ _
MAX6314US38D1-T	3.80	1	CA_ _
MAX6314US37D1-T	3.70	1	CB_ _
MAX6314US36D1-T	3.60	1	CC_ _
MAX6314US35D1-T	3.50	1	CD_ _
MAX6314US34D1-T	3.40	1	CE_ _
MAX6314US33D1-T	3.30	1	CF_ _
MAX6314US32D1-T	3.20	1	CG_ _
MAX6314US31D1-T	3.08	1	CH_ _
MAX6314US30D1-T	3.00	1	CI_ _
MAX6314US29D1-T	2.93	1	CJ_ _
MAX6314US28D1-T	2.80	1	CK_ _
MAX6314US27D1-T	2.70	1	CL_ _
<b>MAX6314US26D1-T†††</b>	2.63	1	CM_ _

PART†	NOMINAL V <sub>TH</sub> (V)	MIN t <sub>RP</sub> (ms)	TOP MARK††
MAX6314US25D1-T	2.50	1	CN_ _
MAX6314US50D2-T	5.00	20	CO_ _
MAX6314US49D2-T	4.90	20	CP_ _
MAX6314US48D2-T	4.80	20	CQ_ _
MAX6314US47D2-T	4.70	20	CR_ _
MAX6314US46D2-T	4.63	20	CS_ _
MAX6314US45D2-T	4.50	20	CT_ _
<b>MAX6314US44D2-T†††</b>	4.39	20	CU_ _
MAX6314US43D2-T	4.30	20	CV_ _
MAX6314US42D2-T	4.20	20	CW_ _
MAX6314US41D2-T	4.10	20	CX_ _
MAX6314US40D2-T	4.00	20	CY_ _
MAX6314US39D2-T	3.90	20	CZ_ _
MAX6314US38D2-T	3.80	20	DA_ _
MAX6314US37D2-T	3.70	20	DB_ _
MAX6314US36D2-T	3.60	20	DC_ _
MAX6314US35D2-T	3.50	20	DD_ _
MAX6314US34D2-T	3.40	20	DE_ _
MAX6314US33D2-T	3.30	20	DJ_ _

† The MAX6314 is available in a SOT143 package, -40°C to +85°C temperature range.

†† The first two letters in the package top mark identify the part, while the remaining two letters are the lot tracking code.

††† Sample stocks generally held on the bolded products; also, the bolded products have 2,500 piece minimum-order quantities.

Non-bolded products have 10,000 piece minimum-order quantities. Contact factory for details.

Devices are available in both leaded and lead-free packaging. Specify lead-free by replacing "-T" with "+T" when ordering.

**Note:** All devices available in tape-and-reel only. Contact factory for availability.

# 68HC11/Bidirectional-Compatible μP Reset Circuit

## Ordering and Marking Information (continued)

PART†	NOMINAL V <sub>TH</sub> (V)	MIN t <sub>RP</sub> (ms)	TOP MARK††
MAX6314US32D2-T	3.20	20	DK__
MAX6314US31D2-T	3.08	20	DL__
MAX6314US30D2-T	3.00	20	DM__
MAX6314US29D2-T	2.93	20	DN__
MAX6314US28D2-T	2.80	20	DO__
MAX6314US27D2-T	2.70	20	DP__
<b>MAX6314US26D2-T†††</b>	2.63	20	DQ__
MAX6314US25D2-T	2.50	20	DR__
MAX6314US50D3-T	5.00	140	DS__
MAX6314US49D3-T	4.90	140	DT__
MAX6314US48D3-T	4.80	140	DU__
MAX6314US47D3-T	4.70	140	DV__
<b>MAX6314US46D3-T†††</b>	4.63	140	DW__
MAX6314US45D3-T	4.50	140	DX__
<b>MAX6314US44D3-T†††</b>	4.39	140	DY__
MAX6314US43D3-T	4.30	140	DZ__
MAX6314US42D3-T	4.20	140	EA__
MAX6314US41D3-T	4.10	140	EB__
MAX6314US40D3-T	4.00	140	EC__
MAX6314US39D3-T	3.90	140	EG__
MAX6314US38D3-T	3.80	140	EH__
MAX6314US37D3-T	3.70	140	EI__
MAX6314US36D3-T	3.60	140	EJ__
MAX6314US35D3-T	3.50	140	EK__
MAX6314US34D3-T	3.40	140	EL__
MAX6314US33D3-T	3.30	140	EM__
MAX6314US32D3-T	3.20	140	EN__
<b>MAX6314US31D3-T†††</b>	3.08	140	EO__
MAX6314US30D3-T	3.00	140	EP__
<b>MAX6314US29D3-T†††</b>	2.93	140	ES__

PART†	NOMINAL V <sub>TH</sub> (V)	MIN t <sub>RP</sub> (ms)	TOP MARK††
MAX6314US28D3-T	2.80	140	ET__
MAX6314US27D3-T	2.70	140	EU__
<b>MAX6314US26D3-T†††</b>	2.63	140	EV__
MAX6314US25D3-T	2.50	140	EW__
MAX6314US50D4-T	5.00	1120	EX__
MAX6314US49D4-T	4.90	1120	EY__
MAX6314US48D4-T	4.80	1120	EZ__
MAX6314US47D4-T	4.70	1120	FA__
MAX6314US46D4-T	4.63	1120	FB__
MAX6314US45D4-T	4.50	1120	FC__
<b>MAX6314US44D4-T†††</b>	4.39	1120	FD__
MAX6314US43D4-T	4.30	1120	FE__
MAX6314US42D4-T	4.20	1120	FF__
MAX6314US41D4-T	4.10	1120	FG__
MAX6314US40D4-T	4.00	1120	FH__
MAX6314US39D4-T	3.90	1120	FI__
MAX6314US38D4-T	3.80	1120	FJ__
MAX6314US37D4-T	3.70	1120	FK__
MAX6314US36D4-T	3.60	1120	FL__
MAX6314US35D4-T	3.50	1120	FM__
MAX6314US34D4-T	3.40	1120	FN__
MAX6314US33D4-T	3.30	1120	FO__
MAX6314US32D4-T	3.20	1120	FP__
MAX6314US31D4-T	3.08	1120	FQ__
MAX6314US30D4-T	3.00	1120	FR__
MAX6314US29D4-T	2.93	1120	FS__
MAX6314US28D4-T	2.80	1120	FT__
MAX6314US27D4-T	2.70	1120	FU__
<b>MAX6314US26D4-T†††</b>	2.63	1120	FV__
MAX6314US25D4-T	2.50	1120	FW__

† The MAX6314 is available in a SOT143 package, -40°C to +85°C temperature range.

†† The first two letters in the package top mark identify the part, while the remaining two letters are the lot tracking code.

††† Sample stocks generally held on the bolded products; also, the bolded products have 2,500 piece minimum-order quantities.

Non-bolded products have 10,000 piece minimum-order quantities. Contact factory for details.

Devices are available in both leaded and lead-free packaging. Specify lead-free by replacing "-T" with "+T" when ordering.

**Note:** All devices available in tape-and-reel only. Contact factory for availability.

### Chip Information

TRANSISTOR COUNT: 519

Maxim cannot assume responsibility for use of any circuitry other than circuitry entirely embodied in a Maxim product. No circuit patent licenses are implied. Maxim reserves the right to change the circuitry and specifications without notice at any time.

8 **Maxim Integrated Products, 120 San Gabriel Drive, Sunnyvale, CA 94086 408-737-7600**

### Package Information

For the latest package outline information, go to  
[www.maxim-ic.com/packages](http://www.maxim-ic.com/packages).

## Looking for pricing, stock, or lifecycle information?

Click below to explore more details on WIN SOURCE:

- ⊖ [View MAX6314US26D4+T on WIN SOURCE](#)
- ⊖ [Maxim Integrated Information](#)

## Optimize Your Supply Chain with WIN SOURCE Solutions

- ✓ Global Sourcing Solution
- ✓ Obsolete Management
- ✓ Cost Control Management
- ✓ Shortage Management
- ✓ Alternative Solution
- ✓ Excess Inventory Management