



**THE DATASHEET OF
MAX6501UKP125+T**





Low-Cost, +2.7V to +5.5V, Micropower Temperature Switches in SOT23

General Description

The MAX6501–MAX6504 low-cost, fully integrated temperature switches assert a logic signal when their die temperature crosses a factory-programmed threshold. Operating from a +2.7V to +5.5V supply, these devices feature two on-chip, temperature-dependent voltage references and a comparator. They are available with factory-trimmed temperature trip thresholds from -45°C to +125°C in 10°C increments, and are accurate to $\pm 0.5^\circ\text{C}$ (typ) or $\pm 6^\circ\text{C}$ (max). These devices require no external components and typically consume 30 μA supply current. Hysteresis is pin-selectable at 2°C or 10°C.

The MAX6501/MAX6503 have an active-low, open-drain output intended to interface with a microprocessor (μP) reset input. The MAX6502/MAX6504 have an active-high, push-pull output intended to directly drive fan-control logic. The MAX6501/MAX6502 are offered with hot-temperature thresholds (+35°C to +125°C), asserting when the temperature is above the threshold. The MAX6503/MAX6504 are offered with cold-temperature thresholds (-45°C to +15°C), asserting when the temperature is below the threshold.

The MAX6501–MAX6504 are offered in eight standard temperature versions; contact the factory for pricing and availability of nonstandard temperature versions. They are available in a 5-pin SOT23 package.

Typical Operating Circuit

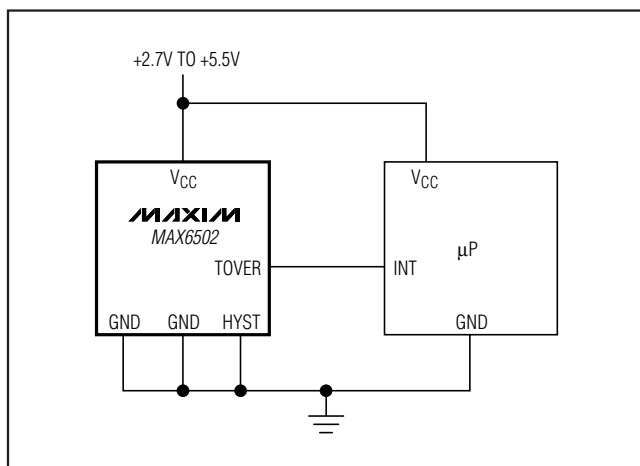

Selector Guide and Pin Configurations appear at end of data sheet.

Features

- ◆ $\pm 0.5^\circ\text{C}$ (typical) Threshold Accuracy Over Full Temperature Range
- ◆ No External Components Required
- ◆ Low Cost
- ◆ 30 μA Supply Current
- ◆ Factory-Programmed Thresholds from -45°C to +125°C in 10°C Increments
- ◆ Open-Drain Output (MAX6501/MAX6503)
Push-Pull Output (MAX6502/MAX6504)
- ◆ Pin-Selectable 2°C or 10°C Hysteresis
- ◆ SOT23-5 Package

Ordering Information

PART	TEMP RANGE	PIN-PACKAGE
MAX6501UK____+T	-55°C to +125°C	5 SOT23
MAX6502UK____+T	-55°C to +125°C	5 SOT23
MAX6503UK____+T	-55°C to +125°C	5 SOT23
MAX6504UK____+T	-55°C to +125°C	5 SOT23

Note: These parts are offered in eight standard temperature versions with a minimum order of 2,500 pieces. To complete the suffix information, add P or N for positive or negative trip temperature, and select an available trip point in degrees centigrade. For example, the MAX6501UKP065+T describes a MAX6501 in a SOT23 package with a +65°C threshold. Contact the factory for pricing and availability of nonstandard temperature versions (minimum order 10,000 pieces). +Denotes a lead(Pb)-free/RoHS-compliant package. T = Tape and reel.

Applications

- μP Temperature Monitoring in High-Speed Computers
- Temperature Control
- Temperature Alarms
- Fan Control

MAX6501–MAX6504

Low-Cost, +2.7V to +5.5V, Micropower Temperature Switches in SOT23

ABSOLUTE MAXIMUM RATINGS

Supply Voltage (V_{CC}) Range.....	-0.3V to +7V	Output Current (all pins)	20mA
\overline{TOVER} (MAX6501)	-0.3V to +7V	Continuous Power Dissipation ($T_A = +70^\circ\text{C}$)	
\overline{TOVER} (MAX6502)	-0.3V to ($V_{CC} + 0.3\text{V}$)	SOT23 (derate 3.1mW/ $^\circ\text{C}$ above $+70^\circ\text{C}$).....	247mW
\overline{TUNDER} (MAX6503)	-0.3V to +7V	Operating Temperature Range	-55°C to $+135^\circ\text{C}$
\overline{TUNDER} (MAX6504)	-0.3V to ($V_{CC} + 0.3\text{V}$)	Storage Temperature Range	-65°C to $+165^\circ\text{C}$
All Other Pins	-0.3V to ($V_{CC} + 0.3\text{V}$)	Lead Temperature (soldering, 10s)	$+300^\circ\text{C}$
Input Current (all pins)	20mA	Soldering Temperature (reflow)	$+260^\circ\text{C}$

Stresses beyond those listed under "Absolute Maximum Ratings" may cause permanent damage to the device. These are stress ratings only, and functional operation of the device at these or any other conditions beyond those indicated in the operational sections of the specifications is not implied. Exposure to absolute maximum rating conditions for extended periods may affect device reliability.

ELECTRICAL CHARACTERISTICS

($V_{CC} = +2.7\text{V}$ to $+5.5\text{V}$, $R_{PULLUP} = 100\text{k}\Omega$ (MAX6501/MAX6503 only), $T_A = T_{MIN}$ to T_{MAX} , unless otherwise noted. Typical values are at $T_A = +25^\circ\text{C}$.) (Note 1)

PARAMETER	SYMBOL	CONDITIONS	MIN	TYP	MAX	UNITS
Supply Voltage Range	V_{CC}		2.7		5.5	V
Supply Current	I_{CC}			30	85	μA
Temperature Threshold Accuracy (Note 2)	ΔT_{TH}	-45°C to -25°C	-6	± 0.5	+6	$^\circ\text{C}$
		-15°C to $+15^\circ\text{C}$	-4	± 0.5	+4	
		$+35^\circ\text{C}$ to $+65^\circ\text{C}$	-4	± 0.5	+4	
		$+75^\circ\text{C}$ to $+125^\circ\text{C}$	-6	± 0.5	+6	
Temperature Threshold Hysteresis	T_{HYST}	HYST = GND		2		$^\circ\text{C}$
		HYST = V_{CC}		10		
HYST Input Threshold (Note 3)	V_{IH}		$0.8 \times V_{CC}$			V
	V_{IL}				$0.2 \times V_{CC}$	
Output Voltage High	V_{OH}	$I_{SOURCE} = 500\mu\text{A}$, $V_{CC} > 2.7\text{V}$ (MAX6502/MAX6504 only)	$0.8 \times V_{CC}$			V
		$I_{SOURCE} = 800\mu\text{A}$, $V_{CC} > 4.5\text{V}$ (MAX6502/MAX6504 only)	$V_{CC} - 1.5$			
Output Voltage Low	V_{OL}	$I_{SINK} = 1.2\text{mA}$, $V_{CC} > 2.7\text{V}$			0.3	V
		$I_{SINK} = 3.2\text{mA}$, $V_{CC} > 4.5\text{V}$			0.4	
Open-Drain Output Leakage Current		$V_{CC} = 2.7\text{V}$, $V_{\overline{TUNDER}} = 5.5\text{V}$ (MAX6503), $V_{\overline{TOVER}} = 5.5\text{V}$ (MAX6501)		10		nA

Note 1: 100% production tested at $T_A = +25^\circ\text{C}$. Specifications over temperature limits are guaranteed by design.

Note 2: The MAX6501–MAX6504 are available with internal, factory-programmed temperature trip thresholds from -45°C to $+125^\circ\text{C}$ in $+10^\circ\text{C}$ increments (see *Selector Guide*).

Note 3: Guaranteed by design.

Low-Cost, +2.7V to +5.5V, Micropower Temperature Switches in SOT23

Typical Operating Characteristics

($V_{CC} = +5V$, $R_{PULLUP} = 100k\Omega$ (MAX6501/MAX6503), $T_A = +25^\circ C$, unless otherwise noted.)

MAX6501-MAX6504

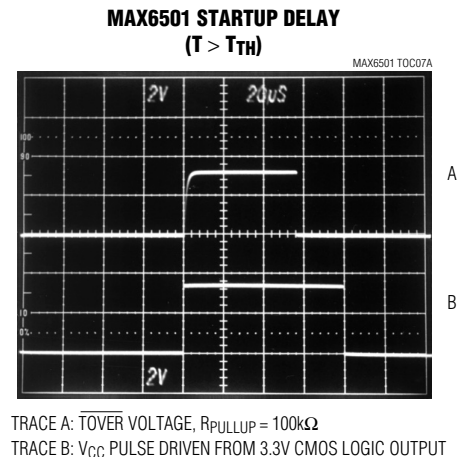
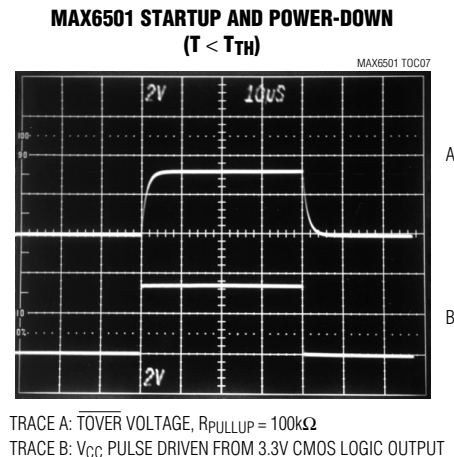
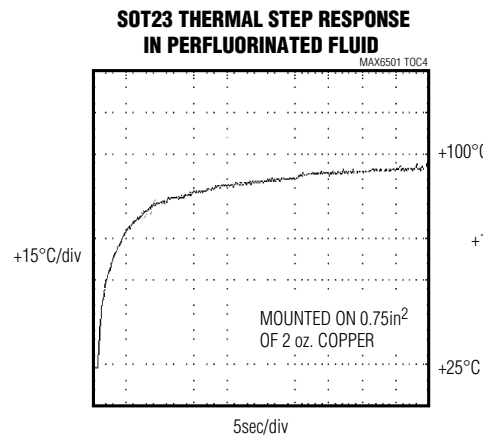
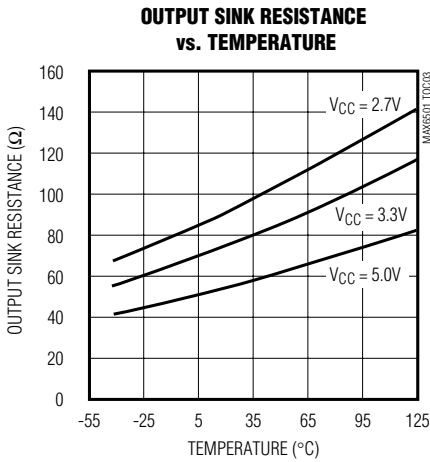

Low-Cost, +2.7V to +5.5V, Micropower Temperature Switches in SOT23

Pin Description

PIN				NAME	FUNCTION
MAX6501	MAX6502	MAX6503	MAX6504		
1, 2	1, 2	1, 2	1, 2	GND	Ground. Not internally connected. Connect both ground pins together close to the chip. Pin 2 provides the lowest thermal resistance to the die.
3	3	3	3	HYST	Hysteresis Input. Connect HYST to GND for 2°C hysteresis, or connect to V _{CC} for 10°C hysteresis.
4	4	4	4	V _{CC}	Supply Input (+2.7V to +5.5V)
5	—	—	—	$\overline{\text{TOVER}}$	Open-Drain, Active-Low Output. $\overline{\text{TOVER}}$ goes low when the die temperature exceeds the factory-programmed temperature threshold. Connect to a 100kΩ pullup resistor. May be pulled up to a voltage higher than V _{CC} .
—	5	—	—	TOVER	Push-Pull Active-High Output. TOVER goes high when the die temperature exceeds the factory-programmed temperature threshold.
—	—	5	—	$\overline{\text{TUNDER}}$	Open-Drain, Active-Low Output. $\overline{\text{TUNDER}}$ goes low when the die temperature goes below the factory-programmed temperature threshold. Connect to a 100kΩ pullup resistor. May be pulled up to a voltage higher than V _{CC} .
—	—	—	5	TUNDER	Push-Pull Active-High Output. TUNDER goes high when the die temperature falls below the factory-programmed temperature threshold.

General Description

The MAX6501–MAX6504 fully integrated temperature switches incorporate two temperature-dependent references and a comparator. One reference exhibits a positive temperature coefficient and the other a negative temperature coefficient (Figure 1). The temperature at which the two reference voltages are equal determines the temperature trip point. Pin-selectable 2°C or 10°C hysteresis keeps the output from oscillating when the die temperature approaches the threshold temperature. The MAX6501/MAX6503 have an active-low, open-drain output structure that can only sink current. The MAX6502/MAX6504 have an active-high, push-pull output structure that can sink or source current. The internal power-on reset circuit guarantees the output is at T_{TH} = +25°C state at startup for 50μs.

The MAX6501–MAX6504 are available with factory-preset temperature thresholds from -45°C to +125°C in 10°C increments. Table 1 lists the available temperature threshold ranges. The MAX6501/MAX6503 outputs are intended to interface with a microprocessor (μP) reset input (Figure 2). The MAX6502/MAX6504 outputs are intended for applications such as driving a fan control (Figure 3).

Table 1. Factory-Programmed Threshold Range

PART	THRESHOLD (T _{TH}) RANGE
MAX6501	+35°C < T _{TH} < +125°C
MAX6502	+35°C < T _{TH} < +125°C
MAX6503	-45°C < T _{TH} < +15°C
MAX6504	-45°C < T _{TH} < +15°C

Hysteresis Input

The HYST pin is a CMOS-compatible input that selects hysteresis at either a high level (10°C for HYST = V_{CC}) or a low level (2°C for HYST = GND). Hysteresis prevents the output from oscillating when the temperature approaches the trip point. The HYST pin should not be left unconnected. Drive HYST close to ground or V_{CC}. Other input voltages cause increased supply current. The actual amount of hysteresis depends on the part's programmed trip threshold (see the *Typical Operating Characteristics*).

Low-Cost, +2.7V to +5.5V, Micropower Temperature Switches in SOT23

MAX6501-MAX6504

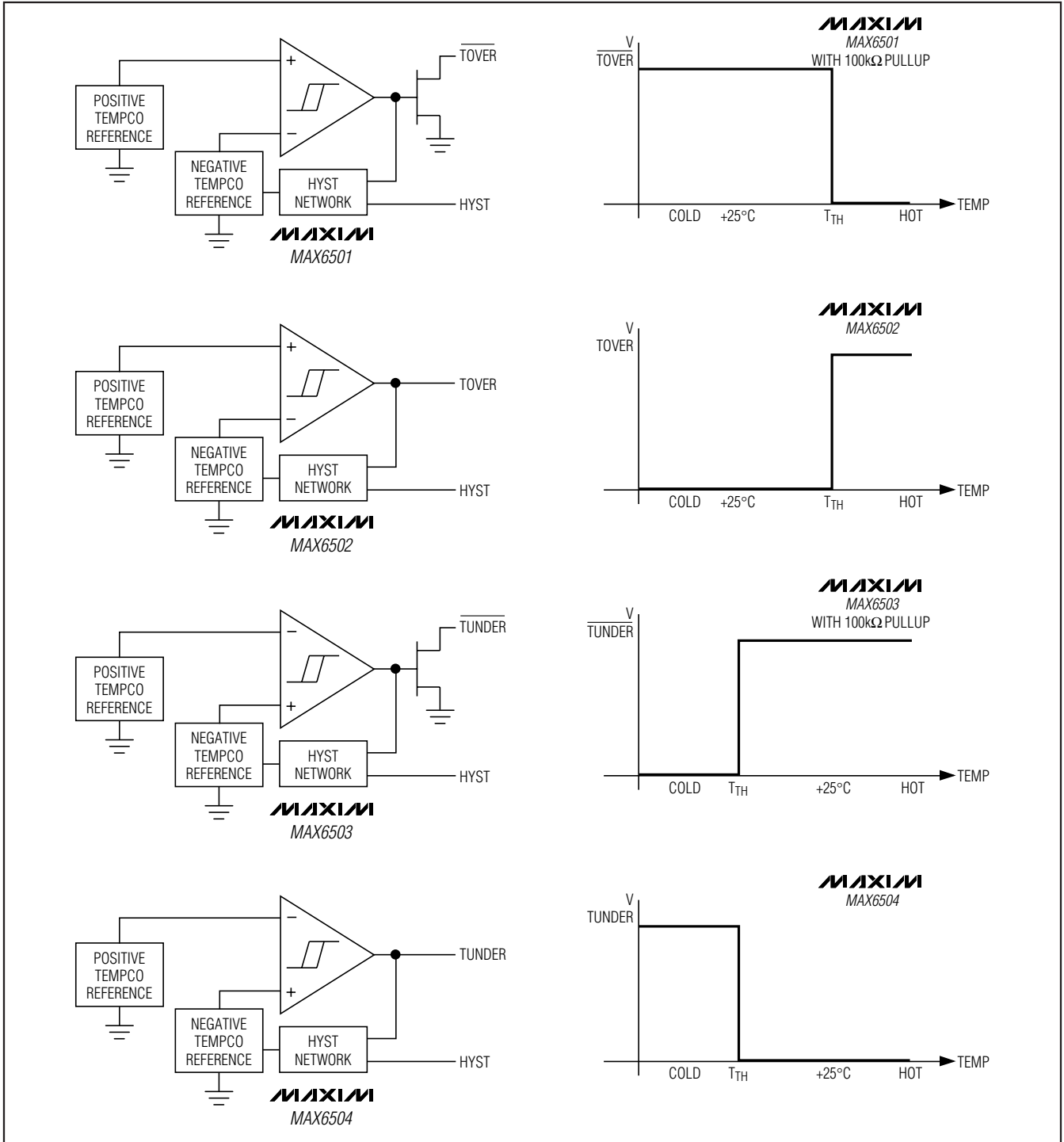

Figure 1. Block and Functional Diagrams

Low-Cost, +2.7V to +5.5V, Micropower Temperature Switches in SOT23



Figure 2. Microprocessor Alarm/Reset



Figure 3. Overtemperature Fan Control

Applications Information

Thermal Considerations

The MAX6501–MAX6504 supply current is typically 30μA. When used to drive high-impedance loads, the devices dissipate negligible power. Therefore, the die temperature is essentially the same as the package temperature. The key to accurate temperature monitoring is good thermal contact between the MAX6501–MAX6504 package and the device being monitored. In some applications, the SOT23 package may be small enough to fit underneath a socketed μP, allowing the device to monitor the μP's temperature directly. Use the monitor's output to reset the μP, assert an interrupt, or trigger an external alarm.

Accurate temperature monitoring depends on the thermal resistance between the device being monitored and the MAX6501–MAX6504 die. Heat flows in and out of plastic packages, primarily through the leads. Pin 2 of the SOT23-5 package provides the lowest thermal resistance to the die. Short, wide copper traces leading to the temperature monitor ensure that heat transfers quickly and reliably.

The rise in die temperature due to self-heating is given by the following formula:

$$\Delta T_J = P_{DISSIPATION} \times \theta_{JA}$$

where $P_{DISSIPATION}$ is the power dissipated by the MAX6501–MAX6504, and θ_{JA} is the package's thermal resistance.

The typical thermal resistance is 140°C/W for the SOT23 package. To limit the effects of self-heating, minimize the output currents. For example, if the MAX6501 or MAX6503 sink 1mA, the output voltage is guaranteed to be less than 0.3V. Therefore, an additional 0.3mW of power is dissipated within the IC. This corresponds to a 0.042°C shift in the die temperature in the SOT23.

Temperature-Window Alarm

The MAX6501–MAX6504 temperature switch outputs assert when the die temperature is outside the factory-programmed range. Combining the outputs of two devices creates an over/undertemperature alarm. The MAX6501/MAX6503 and the MAX6502/MAX6504 are designed to form two complementary pairs, each containing one cold trip-point output and one hot trip-point output. The assertion of either output alerts the system to an out-of-range temperature. The MAX6502/MAX6504 push/pull output stages can be ORed to produce a thermal out-of-range alarm. More favorably, a MAX6501/MAX6503 can be directly wire-ORed with a single external resistor to accomplish the same task (Figure 4).

The temperature window alarms shown in Figure 4 can be used to accurately determine when a device's temperature falls out of the -5°C to +75°C range. The thermal-overrange signal can be used to assert a thermal shutdown, power-up, recalibration, or other temperature-dependent function.

Low-Cost, Fail-Safe Temperature Monitor

In high-performance/high-reliability applications, multiple temperature monitoring is important. The high-level integration and low cost of the MAX6501–MAX6504 facilitate the use of multiple temperature monitors to increase system reliability. Figure 5's application uses two MAX6502s with different temperature thresholds to ensure that fault conditions that can overheat the monitored device cause no permanent damage. The first temperature monitor activates the fan when the die temperature exceeds +45°C. The second MAX6502 triggers a system shutdown if the die temperature reaches +75°C. The second temperature monitor's output asserts when a wide variety of destructive fault conditions occur, including latchups, short circuits, and cooling-system failures.

Low-Cost, +2.7V to +5.5V, Micropower Temperature Switches in SOT23

MAX6501-MAX6504



Figure 4. Temperature-Window Alarms



Figure 5. Low-Power, High-Reliability, Fail-Safe Temperature Monitor

Table 2. Device Marking Codes

DEVICE	CODE	MINIMUM ORDER
MAX6501UKP035	ABZF	10k
MAX6501UKP045	ABZR	2.5k
MAX6501UKP055	ACFW	2.5k
MAX6501UKP065	ABZS	2.5k
MAX6501UKP075	ACFV	2.5k
MAX6501UKP085	ACDP	2.5k
MAX6501UKP095	ABZT	2.5k
MAX6501UKP105	ACFU	10k
MAX6501UKP115	ACAG	2.5k
MAX6501UKP125	ADQK	25k
MAX6502UKP035	ABZG	10k
MAX6502UKP045	ABZU	2.5k
MAX6502UKP055	ACGC	2.5k
MAX6502UKP065	ABZV	2.5k
MAX6502UKP075	ACGB	2.5k
MAX6502UKP085	ACGA	2.5k
MAX6502UKP095	ABZW	2.5k

DEVICE	CODE	MINIMUM ORDER
MAX6502UKP105	ACFZ	10k
MAX6502UKP115	ACFY	2.5k
MAX6502UKP125	ADUD	25k
MAX6503UKN045	ADIZ	10k
MAX6503UKN035	ADVS	10k
MAX6503UKN025	ADVR	10k
MAX6503UKN015	ACFX	2.5k
MAX6503UKN005	ADNZ	10k
MAX6503UKP005	ABZX	2.5k
MAX6503UKP015	ADPN	10k
MAX6504UKN045	ACAX	10k
MAX6504UKN035	ADVU	10k
MAX6504UKN025	ADVT	10k
MAX6504UKN015	ACGD	2.5k
MAX6504UKN005	ADVX	10k
MAX6504UKP005	ABZY	2.5k
MAX6504UKP015	ADKE	10k

Low-Cost, +2.7V to +5.5V, Micropower Temperature Switches in SOT23

Selector Guide

PART	MAX6501	MAX6502	MAX6503	MAX6504	
OUTPUT STAGE	Open-Drain	Push-Pull	Open-Drain	Push-Pull	
TRIP TEMP THRESHOLD	Hot	Hot	Cold	Cold	
STANDARD TEMPERATURE THRESHOLDS (°C)	-45		✓	✓	
	-35		✓	✓	
	-25		✓	✓	
	-15		✓	✓	
	-5		✓	✓	
	+5		✓	✓	
	+15		✓	✓	
	+35	✓	✓		
	+45	✓	✓		
	+55	✓	✓		
	+65	✓	✓		
	+75	✓	✓		
	+85	✓	✓		
	+95	✓	✓		
	+105	✓	✓		
+115	✓	✓			
+125	✓	✓			

Pin Configurations



Chip Information

SUBSTRATE CONNECTED TO GND

Package Information

For the latest package outline information and land patterns (footprints), go to www.maxim-ic.com/packages. Note that a "+", "#", or "-" in the package code indicates RoHS status only. Package drawings may show a different suffix character, but the drawing pertains to the package regardless of RoHS status.

PACKAGE TYPE	PACKAGE CODE	OUTLINE NO.	LAND PATTERN NO.
5 SOT23	U5+2	21-0057	90-0174

Low-Cost, +2.7V to +5.5V, Micropower Temperature Switches in SOT23

Revision History

REVISION NUMBER	REVISION DATE	DESCRIPTION	PAGES CHANGED
5	10/06	In Table 2 updated the device marking codes for MAX6503UKN035, MAX6503UKN025, MAX6503UKN005, MAX6503UKP015, MAX6504UKN035, MAX6504UKN025, and MAX6504UKN005	7
6	2/11	Removed the TO-220 package from entire data sheet; changed all leaded parts to lead(Pb)-free parts in the <i>Ordering Information</i> table; in the <i>Absolute Maximum Ratings</i> section changed the continuous power dissipation numbers (7.1mW/°C to 3.1mW/°C and 571mW to 247mW) and added the soldering temperature; added the <i>Package Information</i> table	All

MAX6501-MAX6504

Maxim cannot assume responsibility for use of any circuitry other than circuitry entirely embodied in a Maxim product. No circuit patent licenses are implied. Maxim reserves the right to change the circuitry and specifications without notice at any time.

Maxim Integrated Products, 120 San Gabriel Drive, Sunnyvale, CA 94086 408-737-7600 _____ 9

Looking for pricing, stock, or lifecycle information?

Click below to explore more details on WIN SOURCE:

- ⊖ [View MAX6501UKP125+T on WIN SOURCE](#)
- ⊖ [Maxim Integrated Information](#)

Optimize Your Supply Chain with WIN SOURCE Solutions

- ✓ Global Sourcing Solution
- ✓ Obsolete Management
- ✓ Cost Control Management
- ✓ Shortage Management
- ✓ Alternative Solution
- ✓ Excess Inventory Management