



**THE DATASHEET OF
MAX6605MXK-T**





Low-Power Analog Temperature Sensor in SC70 Package

MAX6605

General Description

The MAX6605 precision, low-power, analog output temperature sensor is available in a 5-pin SC70 package. The device has a +2.7V to +5.5V supply voltage range and 10 μ A supply current over the -55°C to +125°C temperature range. For the -40°C to +105°C temperature range, the supply voltage can go as low as +2.4V. Accuracy is $\pm 0.75^\circ\text{C}$ at $T_A = +25^\circ\text{C}$ and $\pm 3^\circ\text{C}$ from 0°C to +70°C.

The MAX6605 output voltage is dependent on its die temperature and has a slope of 11.9mV/ $^\circ\text{C}$ and an offset of 744mV at 0°C. The output typically shows only +0.4°C of nonlinearity over the -20°C to +85°C temperature range.

Applications

Cellular Phones
Battery Packs
GPS Equipment
Digital Cameras

Features

- ◆ Low Current Consumption (10 μ A max)
- ◆ Small SC70 Package
- ◆ Accurate ($\pm 0.75^\circ\text{C}$ at $T_A = +25^\circ\text{C}$)
- ◆ Optimized to Drive Large Capacitive Loads

Ordering Information

PART	TEMP RANGE	PIN-PACKAGE
MAX6605MXK-T	-55°C to +125°C	5 SC70-5
MAX6605MXK+T	-55°C to +125°C	5 SC70-5
MAX6605MXK/V+T	-40°C to +85°C	5 SC70-5

+ Denotes a lead(Pb)-free/RoHS-compliant package.

T = Tape and reel.

V denotes an automotive qualified part.

Pin Configuration

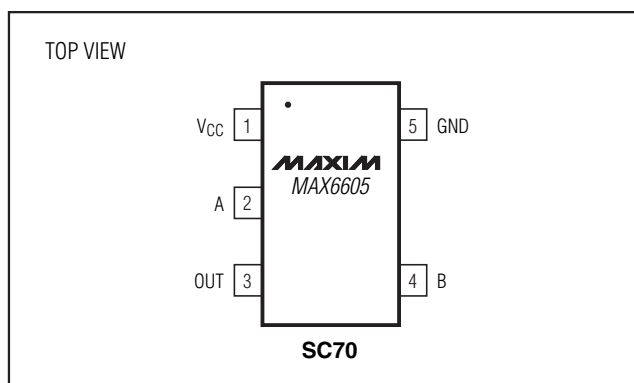

Typical Application Circuit

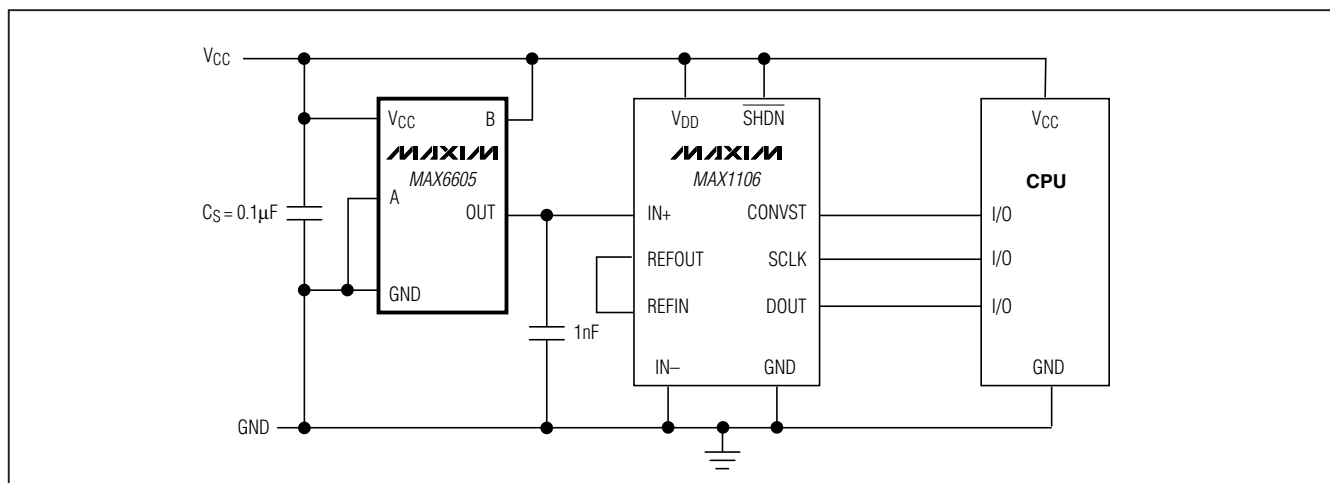

Low-Power Analog Temperature Sensor in SC70 Package

ABSOLUTE MAXIMUM RATINGS

V_{CC} to GND-0.3V to +6V
 OUT, A, B to GND-0.3V to (V_{CC} + 0.3V)
 ESD Protection (Human Body Model)> 2000V
 Current into Any Pin10mA
 Output Short-Circuit Duration.....Continuous

Continuous Power Dissipation (T_A = +70°C)
 5-Pin SC70 (derate 3.1mW/°C above +70°C).....245mW
 Operating Temperature Range-55°C to +125°C
 Junction Temperature+150°C
 Storage Temperature Range-65°C to +150°C
 Lead Temperature (soldering, 10s)+300°C

Stresses beyond those listed under "Absolute Maximum Ratings" may cause permanent damage to the device. These are stress ratings only, and functional operation of the device at these or any other conditions beyond those indicated in the operational sections of the specifications is not implied. Exposure to absolute maximum rating conditions for extended periods may affect device reliability.

ELECTRICAL CHARACTERISTICS

(V_{CC} = +2.7V to +5.5V, C_L = 1nF, T_A = -55°C to +125°C, unless otherwise noted.) (Note 1)

PARAMETER	SYMBOL	CONDITIONS	MIN	TYP	MAX	UNITS
Temperature Error V _{OUT} = 0.744 + (0.0119 × T°C) + (1.604 × 10 ⁻⁶ × T ²)V (Note 2)		V _{CC} = +3.3V	T _A = +25°C	±0.75		°C
			T _A = -0°C to +70°C	-3.0	+3.0	
			T _A = -20°C to +85°C	-3.8	+3.8	
			T _A = -40°C to +100°C	-5.0	+5.0	
			T _A = -55°C to +125°C	-5.8	+5.8	
Supply Voltage	V _{CC}	T _A = -55°C to +125°C	2.7		5.5	V
		T _A = -40°C to +105°C	2.4		5.5	
Supply Current	I _Q	No load		4.5	10	μA
Output Voltage	V _{OUT}	T _A = 0°C		744		mV
Nonlinearity		T _A = -20°C to +85°C		0.4		°C
Sensor Gain (Average Slope)		T _A = -40°C to +100°C	11.1	11.9	12.7	mV/°C
Capacitive Load		Required for stability	1			nF
Load Regulation		T _A = -20°C to +125°C, I _{OUT} = -20μA to +20μA			20	m°C/μA
		T _A = -55°C, I _{OUT} = -10μA to +10μA			20	

Note 1: All parameters are measured at T_A = +25°C. Specifications over temperature range are guaranteed by design.

Note 2: Error (expressed in °C) is defined as the difference between the calculated and measured values of output voltage. Guaranteed by design to 5 sigma.

Low-Power Analog Temperature Sensor in SC70 Package

Typical Operating Characteristics

($V_{CC} = +3.3V$, $C_S = 0.1\mu F$, $C_L = 1nF$, unless otherwise noted.)

MAX6605

OUTPUT VOLTAGE vs. TEMPERATURE

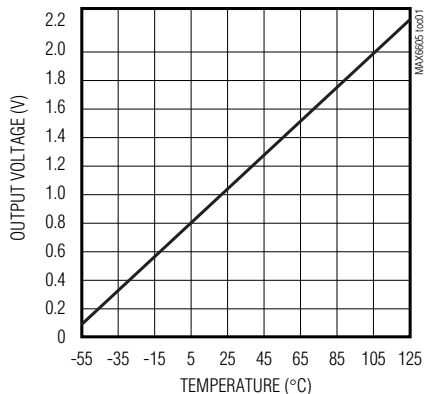

TEMPERATURE ERROR vs. TEMPERATURE

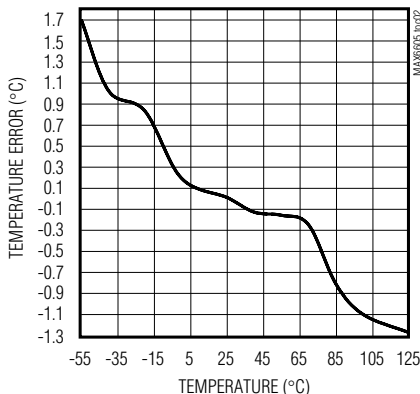

SUPPLY CURRENT vs. SUPPLY VOLTAGE

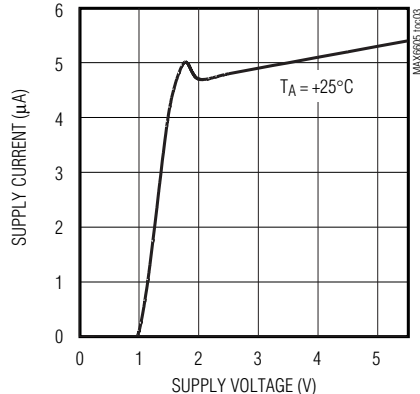

SUPPLY CURRENT vs. TEMPERATURE

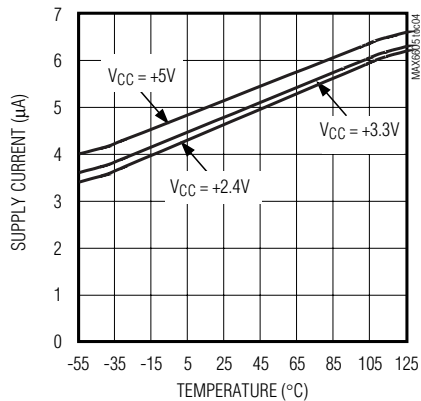

OUTPUT VOLTAGE vs. SUPPLY VOLTAGE

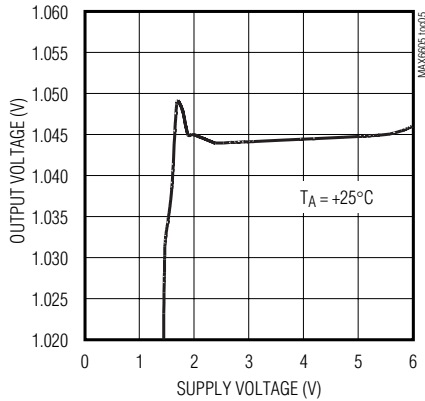

STEP-RESPONSE FROM +25°C TO +100°C (FLUORINERT BATH)

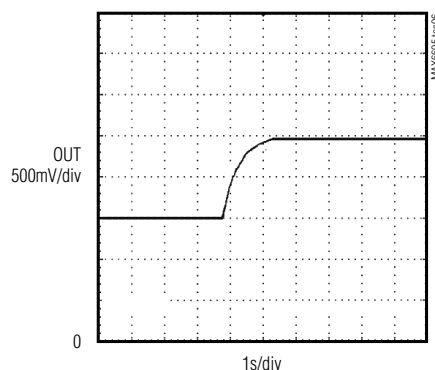

Low-Power Analog Temperature Sensor in SC70 Package

Pin Description

PIN	NAME	FUNCTION
1	V _{CC}	Supply Input. Decouple with a 0.1μF capacitor to GND.
2	A	Must be connected to GND.
3	OUT	Temperature Sensor Output, C _L ≥ 1nF
4	B	Must be connected to V _{CC} .
5	GND	Ground

Detailed Description

The MAX6605 analog output temperature sensor's output voltage is a linear function of its die temperature. The slope of the output voltage is 11.9mV/°C, and there is a 744mV offset at 0°C to allow measurement of negative temperatures. The MAX6605 has three terminals: V_{CC}, GND, and OUT. The maximum supply current is 10μA, and the supply voltage range is from +2.4V to +5.5V for the -40°C to +105°C temperature range and +2.7V to +5.5V for the -55°C to +125°C temperature range. The temperature error is <1°C at T_A = +25°C, <3.8°C from T_A = -20°C to +85°C, and <5.8°C from T_A = -55°C to +125°C.

Nonlinearity

The benefit of silicon analog temperature sensors over thermistors is linearity over extended temperatures. The nonlinearity of the MAX6605 is typically 0.4°C over the -20°C to +85°C temperature range.

Transfer Function

The temperature-to-voltage transfer function has an approximately linear positive slope and can be described by the equation:

$$V_{OUT} = 744\text{mV} + (T \times 11.9\text{mV}/^{\circ}\text{C})$$

where T is the MAX6605's die temperature in °C.

Therefore:

$$T (^{\circ}\text{C}) = (V_{OUT} - 744\text{mV}) / 11.9\text{mV}/^{\circ}\text{C}$$

To account for the small amount of curvature in the transfer function, use the equation below to obtain a more accurate temperature reading:

$$V_{OUT} = 0.744\text{V} + 0.0119\text{V}/^{\circ}\text{C} \times T(^{\circ}\text{C}) + 1.604 \times 10^{-6} \text{ V}/^{\circ}\text{C}^2 \times (T(^{\circ}\text{C}))^2$$

Applications Information

Sensing Circuit Board and Ambient Temperatures

Temperature sensor ICs like the MAX6605 that sense their own die temperatures must be mounted on, or close to, the object whose temperature they are intended to measure. Because there is a good thermal path between the SC70 package's metal leads and the IC die, the MAX6605 can accurately measure the temperature of the circuit board to which it is soldered. If the sensor is intended to measure the temperature of a heat-generating component on the circuit board, it should be mounted as close as possible to that component and should share supply and ground traces (if they are not noisy) with that component where possible. This will maximize the heat transfer from the component to the sensor.

The thermal path between the plastic package and the die is not as good as the path through the leads, so the MAX6605, like all temperature sensors in plastic packages, is less sensitive to the temperature of the surrounding air than it is to the temperature of its leads. It can be successfully used to sense ambient temperature if the circuit board is designed to track the ambient temperature.

As with any IC, the wiring and circuits must be kept insulated and dry to avoid leakage and corrosion, especially if the part will be operated at cold temperatures where condensation can occur.

The thermal resistance junction to ambient (θ_{JA}) is the parameter used to calculate the rise of a device junction temperature (T_J) due to its power dissipation. For the MAX6605, use the following equation to calculate the rise in die temperature:

$$T_J = T_A + \theta_{JA} ((V_{CC} \times I_Q) + (V_{CC} - V_{OUT}) I_{OUT})$$

The MAX6605 is a very-low-power temperature sensor and is intended to drive very light loads. As a result, the temperature rise due to power dissipation on the die is insignificant under normal conditions. For example, assume that the MAX6605 is operating from a +3V supply at +21.6°C (V_{OUT} = 1V) and is driving a 100kΩ load (I_{OUT} = 10μA). In the 5-pin SC70 package, the die temperature will increase above the ambient by:

$$T_J - T_A = \theta_{JA} ((V_{CC} \times I_Q) + (V_{CC} - V_{OUT}) I_{OUT}) = 324^{\circ}\text{C}/\text{W} \times ((3\text{V} \times 10\mu\text{A}) + (3\text{V} - 1\text{V}) \times 10\mu\text{A}) = 0.0162^{\circ}\text{C}$$

Therefore, the error caused by power dissipation will be negligible.

Low-Power Analog Temperature Sensor in SC70 Package

Capacitive Loads

The MAX6605 can drive unlimited load capacitance. For stable operation load capacitance should be $\geq 1\text{nF}$.

Chip Information

TRANSISTOR COUNT: 573

Package Information

For the latest package outline information and land patterns, go to www.maxim-ic.com/packages. Note that a "+", "#", or "-" in the package code indicates RoHS status only. Package drawings may show a different suffix character, but the drawing pertains to the package regardless of RoHS status.

PACKAGE TYPE	PACKAGE CODE	DOCUMENT NO.
5 SC70	X5-1	21-0076

MAX6605

Low-Power Analog Temperature Sensor in SC70 Package

Revision History

REVISION NUMBER	REVISION DATE	DESCRIPTION	PAGES CHANGED
0	10/00	Initial release	—
1	8/04	—	—
2	11/08	Corrected the parameter unit for V_{OUT} in the <i>Transfer Function</i> section.	4
3	12/09	Added lead-free and automotive-qualified parts to the <i>Ordering Information</i> table.	1

Maxim cannot assume responsibility for use of any circuitry other than circuitry entirely embodied in a Maxim product. No circuit patent licenses are implied. Maxim reserves the right to change the circuitry and specifications without notice at any time.

6 **Maxim Integrated Products, 120 San Gabriel Drive, Sunnyvale, CA 94086 408-737-7600**

Looking for pricing, stock, or lifecycle information?

Click below to explore more details on WIN SOURCE:

 [View MAX6605MXK-T on WIN SOURCE](#)

 [Maxim Integrated](#) Information

Optimize Your Supply Chain with WIN SOURCE Solutions

-  Global Sourcing Solution
-  Obsolete Management
-  Cost Control Management
-  Shortage Management
-  Alternative Solution
-  Excess Inventory Management