



THE DATASHEET OF MAX755ESA-T





-5V/Adjustable, Negative-Output, Inverting, Current-Mode PWM Regulators

General Description

The MAX735 and MAX755 are CMOS, inverting switch-mode regulators with internal power MOSFETs. The MAX755 operates from a +2.7V to +9V input and generates an adjustable negative output; 1W output power is guaranteed when powered from a +4.5V input. The MAX735 operates from a +4.0V to +6.2V input; 200mA output current is guaranteed for inputs greater than +4.5V. Quiescent supply current for the MAX735 is typically 1.6mA, and a shutdown mode reduces this to 10 μ A. These power-conserving features, along with high efficiency and applications circuits that lend themselves to miniaturization, make the MAX735/MAX755 excel in a broad range of on-card and portable-equipment applications.

The MAX735/MAX755 employ a high-performance current-mode pulse-width modulation (PWM) control scheme to provide tight output-voltage regulation and low subharmonic noise. The fixed-frequency oscillator is factory-trimmed to 160kHz, allowing for easy noise filtering. The regulators are production tested in actual application circuits, and output accuracy is guaranteed to within $\pm 5\%$ over all specified conditions of line, load, and temperature.

The input-to-output differential of the MAX755 is limited to $V_{IN} + IV_{OUT1} \leq 11.7V$.

For an adjustable-output device with a wider input voltage range, refer to the MAX759 data sheet. For a fixed -5V part with a wider input voltage range, refer to the MAX739 data sheet. For fixed -12V and -15V versions, see the MAX736 and MAX737 data sheets. For lower-power applications, refer to the MAX635/636/637 data sheet.

Applications

Board-Level DC-DC Conversion
Battery-Powered Equipment
Computer Peripherals

Typical Operating Circuit

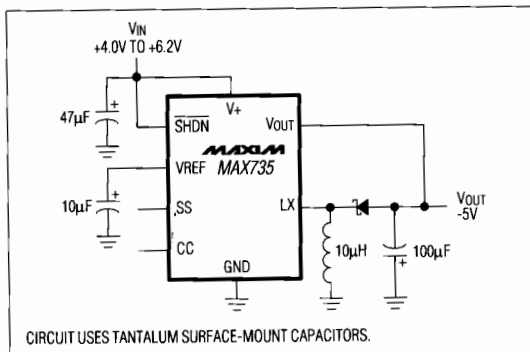

Features

- ◆ Converts +2.7V to +9V Input to Adjustable Negative Output (MAX755)
- ◆ Converts +4.0V to +6.2V Input to -5V Output (MAX735)
- ◆ 1W Guaranteed Output Power ($V_{IN} \geq 4.5V$)
- ◆ 78% Typical Efficiency
- ◆ 1.6mA Quiescent Current (MAX735)
- ◆ 10 μ A Shutdown Mode
- ◆ 160kHz Fixed-Frequency Oscillator
- ◆ Current-Mode PWM - Low Noise and Jitter
- ◆ Soft-Start
- ◆ Simple Application Circuit

Ordering Information

PART	TEMP. RANGE	PIN-PACKAGE
MAX735CPA	0°C to +70°C	8 Plastic DIP
MAX735CSA	0°C to +70°C	8 SO
MAX735C/D	0°C to +70°C	Dice*
MAX735EPA	-40°C to +85°C	8 Plastic DIP
MAX735ESA	-40°C to +85°C	8 SO
MAX735MJA	-55°C to +125°C	8 CERDIP**
MAX755CPA	0°C to +70°C	8 Plastic DIP
MAX755CSA	0°C to +70°C	8 SO
MAX755C/D	0°C to +70°C	Dice*
MAX755EPA	-40°C to +85°C	8 Plastic DIP
MAX755ESA	-40°C to +85°C	8 SO
MAX755MJA	-55°C to +125°C	8 CERDIP**

* Contact factory for dice specifications.

** Contact factory for availability and processing to MIL-STD-883.

Pin Configuration

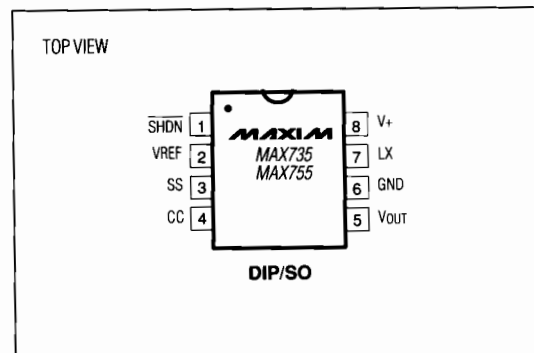

MAX735/MAX755



Maxim Integrated Products 1

Call toll free 1-800-998-8800 for free samples or literature.

-5V/Adjustable, Negative-Output, Inverting, Current-Mode PWM Regulators

ABSOLUTE MAXIMUM RATINGS

Supply Voltage (V+ to GND)	MAX735 +7V, -0.3V
	MAX755 (Note 1) +11, -0.3V
Switch Voltage (LX to V+) -12.5V, +0.3V
Feedback Voltage (VOUT to GND) ±25V
Auxiliary Input Voltages (SS, CC, SHDN to GND) -0.3V to (V+ + 0.3V)
Peak Switch Current (ILX) 2.0A
Reference Current (I _{VREF}) 2.5mA
Continuous Power Dissipation (T _A = +70°C)	
Plastic DIP (derate 9.09mW/°C above +70°C) 727mW
SO (derate 5.88mW/°C above +70°C) 471mW
CERDIP (derate 8.00mW/°C above +70°C) 640mW

Operating Temperature Ranges:

MAX7_5C_	0°C to +70°C
MAX7_5E_	-40°C to +85°C
MAX7_5MJA	-55°C to +125°C
Junction Temperatures:	
MAX7_5C/E_	+150°C
MAX7_5MJA	+175°C
Storage Temperature Range	-65°C to +160°C
Lead Temperature (soldering, 10 sec)	+300°C

Stresses beyond those listed under "Absolute Maximum Ratings" may cause permanent damage to the device. These are stress ratings only, and functional operation of the device at these or any other conditions beyond those indicated in the operational sections of the specifications is not implied. Exposure to absolute maximum rating conditions for extended periods may affect device reliability.

ELECTRICAL CHARACTERISTICS

(Circuit of Figure 2, V+ = 5V, -5.25V ≤ V_{OUT} ≤ -4.75V, I_{LOAD} = 0mA, T_A = T_{MIN} to T_{MAX}, typical values are at T_A = +25°C, unless otherwise noted.)

PARAMETER	CONDITIONS	MIN	TYP	MAX	UNITS	
Input Voltage Range	MAX735	4.0		6.2	V	
	MAX755 (Note 1)	2.7		9.0		
Output Voltage	V+ = 4.5V to 6.2V	0mA < I _{LOAD} < 200mA, T _A = 0°C to +70°C, -40°C to +85°C (MAX735) T _A = 0°C to +70°C (MAX755)	-5.25	-5.0	-4.75	V
		0mA < I _{LOAD} < 175mA, T _A = -55°C to +125°C (MAX735) T _A = -40°C to +85°C, -55°C to +125°C (MAX755)	-5.25	-5.0	-4.75	
Output Current	V+ = 4.5V to 6.2V	T _A = 0°C to +70°C, -40°C to +85°C (MAX735) T _A = 0°C to +70°C (MAX755)	200	275		mA
		T _A = -55°C to +125°C (MAX735) T _A = -40°C to +85°C, -55°C to +125°C (MAX755)	175			
	V+ = 4.0V, V _{OUT} = -5V		175			
	V+ = 2.7V, V _{OUT} = -5V, MAX755 only		125			
Line Regulation	V+ = 4.0V to 6.2V		0.1		%/V	
Load Regulation	I _{LOAD} = 0mA to 200mA		0.001		%/mA	
Efficiency	I _{LOAD} = 100mA		78		%	
Supply Current	Includes switch current	MAX735	1.6	3.0	mA	
		MAX755	1.8	3.5		
Standby Current	V _{SHDN} = 0V		10	100	μA	
Short-Circuit Current			1.5		A	
Undervoltage Lock-Out	MAX735 only		3.7	4.0	V	
LX On Resistance			0.5		Ω	
LX Leakage Current	V _{DS} = 10V		1		μA	
Reference Voltage	T _A = +25°C (Note 3)	1.15	1.23	1.30	V	
Reference Drift	T _A = T _{MIN} to T _{MAX}		50		ppm/°C	
Oscillator Frequency			160		kHz	
Compensation Pin Impedance			7500		Ω	
SHDN Input Current				1	μA	
SHDN Logic High		2.0			V	
SHDN Logic Low				0.25	V	

Note 1: Additionally, V_{IN} is limited to: V_{IN} ≤ 11.7V - |V_{OUT}|

Note 2: MAX755 external feedback resistor tolerance is 0.1%.

Note 3: Tested at I_{VREF} = 0μA for the MAX735, I_{VREF} = 125μA for the MAX755.

-5V/Adjustable, Negative-Output, Inverting, Current-Mode PWM Regulators

Typical Operating Characteristics

MAX735/MAX755

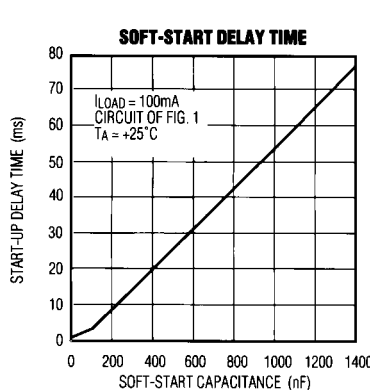
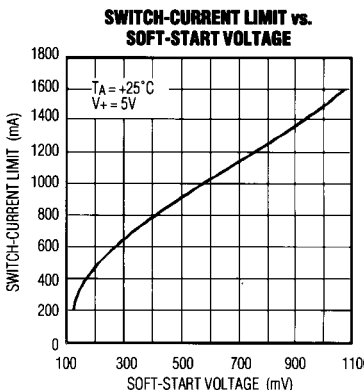
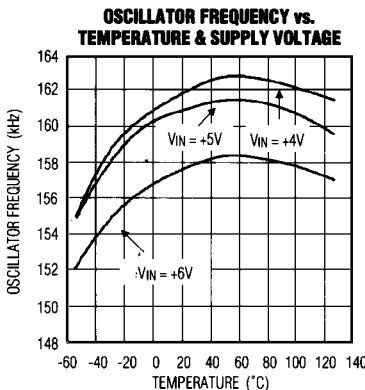
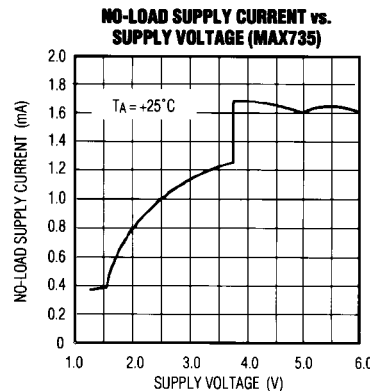
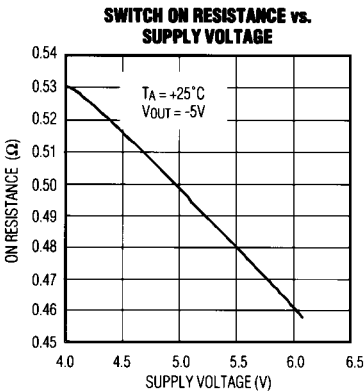
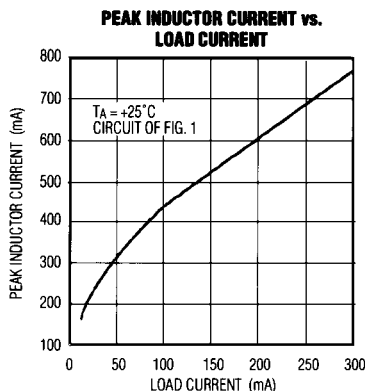
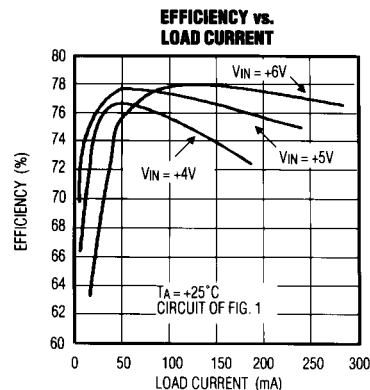
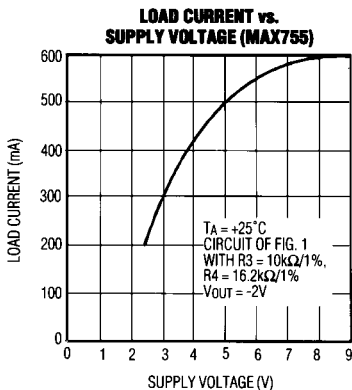
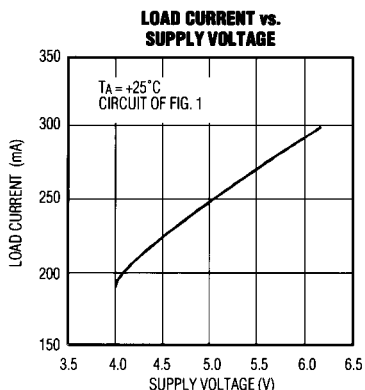

-5V/Adjustable, Negative-Output, Inverting, Current-Mode PWM Regulators

Typical Operating Characteristics (continued)

SWITCHING WAVEFORMS

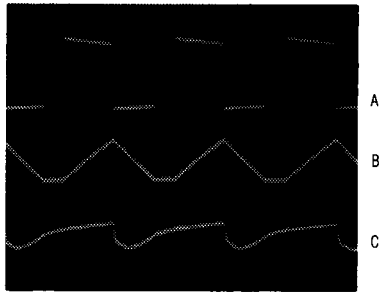

A = SWITCH VOLTAGE (LX), 5V/div
 B = INDUCTOR CURRENT, 500mA/div
 C = OUTPUT VOLTAGE RIPPLE, 50mV/div
 TIMEBASE = 2 μ s/div
 CIRCUIT OF FIG. 1
 $V_{IN} = 5V$
 $T_A = +25^{\circ}C$

LOAD-TRANSIENT RESPONSE

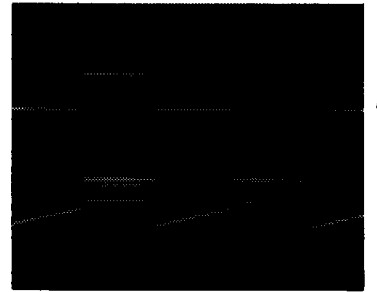

A = LOAD CURRENT, 0mA TO 200mA
 B = OUTPUT VOLTAGE, 50mV/div
 TIMEBASE = 10ms/div
 CIRCUIT OF FIG. 1
 $V_{IN} = 5V$
 $T_A = +25^{\circ}C$

LINE-TRANSIENT RESPONSE

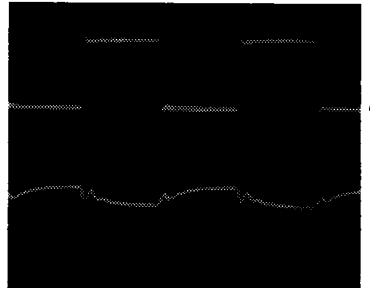

A = INPUT VOLTAGE, 4V TO 6V
 B = OUTPUT VOLTAGE, 50mV/div
 TIMEBASE = 500 μ s/div
 CIRCUIT OF FIG. 1
 $I_{LOAD} = 100mA$
 $T_A = +25^{\circ}C$

Pin Description

PIN	NAME	FUNCTION
1	SHDN	SHUTDOWN Control. V+ = normal operation, GND = shutdown.
2	VREF	Reference Voltage Output = 1.23V. Supplies up to 125 μ A for external loads.
3	SS	Soft-Start
4	CC	Compensation Input of the error amplifier and feedback summing node.
5	V _{OUT}	Output Voltage feedback terminal (actually an input); connected to internal resistors (MAX735). Also provides MOSFET driver bias.
6	GND	Ground
7	LX	Switch Output - internal P-channel MOSFET drain
8	V+	Positive Supply-Voltage Input. Bypass with a 1μF ceramic capacitor close to V+ and GND pins. Use additional bypass capacitor as shown in Figures 1, 2, and 3.

-5V/Adjustable, Negative-Output, Inverting, Current-Mode PWM Regulators

MAX735/MAX755

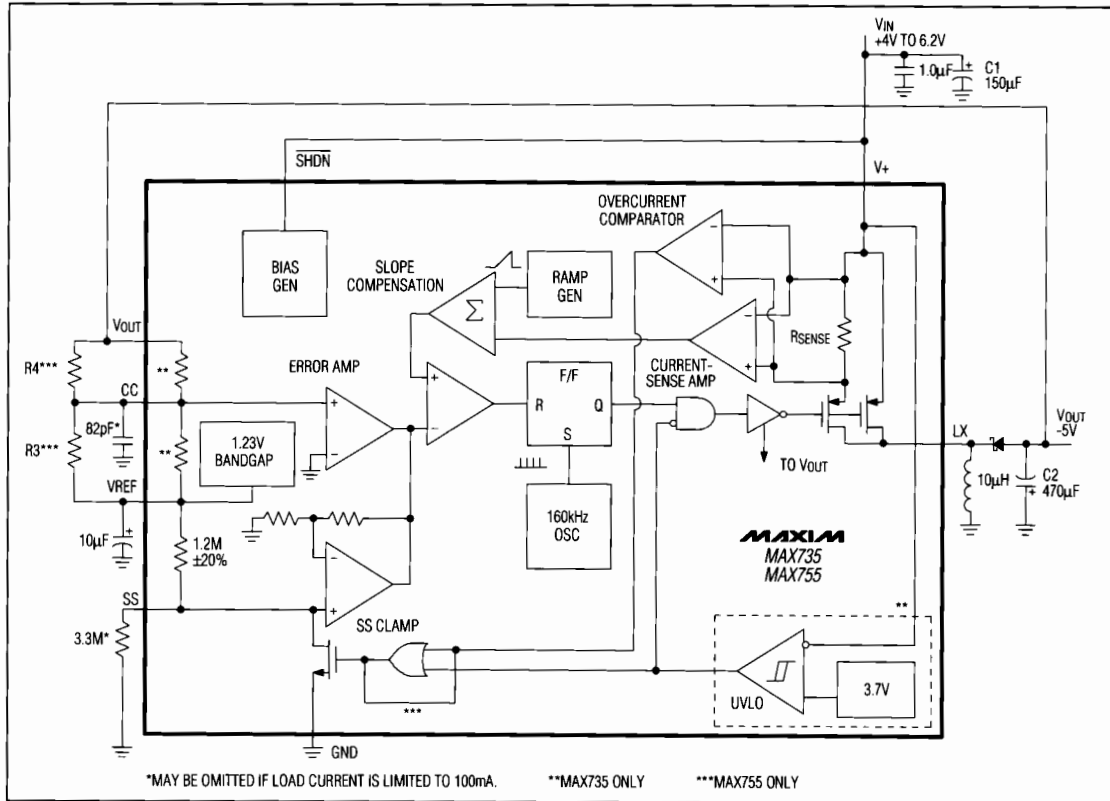

Figure 4. Detailed Block Diagram

Figure 2's circuit provides a through-hole solution for commercial-temperature operation. The capacitors are radial-lead aluminum electrolytics with an ESR of approximately 100mΩ at +25°C. These and other standard aluminum electrolytic capacitors have an ESR 100 times greater at -55°C than at +25°C, so they are not recommended for operation below 0°C. Since output voltage ripple is proportional to the ESR of the output filter capacitor, the ripple with standard aluminum electrolytic capacitors is 1.4 times that associated with tantalum capacitors.

Refer to Figure 3 for a wide-temperature, through-hole solution. The capacitors are organic semiconductor (Os-Con) aluminum electrolytics, which exhibit low ESR over a wide temperature range (typically 30mΩ at +25°C and -55°C).

Table 1 lists component suppliers for the circuits discussed above.

If the load current is limited to 100mA, R1, R2, and C3 (Figures 1-3) may be omitted. **The 1.0µF V+ bypass capacitor must be placed as close as possible to pins 6 and 8.**

Output-Ripple Filtering

An optional lowpass pi-filter (Figures 1-3) can be added to the output to reduce output ripple to about 5mV_{p-p}. The cutoff frequency of the filter shown is 21kHz. Since the filter inductor is in series with the circuit output, its resistance should be minimized to avoid excessive voltage drop. Note that the feedback must be taken before the filter, not after the filter.

-5V/Adjustable, Negative-Output, Inverting, Current-Mode PWM Regulators

MAX735/MAX755

Soft-Start Buffer

The voltage applied to the Soft-Start (SS) input determines the peak switch-current limit (see Soft-Start Delay Time graph in *Typical Operating Characteristics*). A capacitor attached to SS ensures an orderly power-up sequence by gradually increasing the current limit. SS is pulled up to VREF internally through a 1.2MΩ resistor. The maximum current limit can be fixed externally at a lower than normal value by clamping the SS voltage to a voltage less than VREF. An SS cycle is initiated whenever either an undervoltage lockout (MAX735 only) or overcurrent fault condition triggers an internal transistor to discharge the SS capacitor to ground. Note that the SS capacitor should be at least 10nF for the overcurrent limit to function properly.

Undervoltage Lockout

The MAX735 operates for supply voltages greater than 3.7V typ (4V guaranteed), with 0.25V of hysteresis. Internal control logic holds the output power MOSFET off until the supply rises above the undervoltage threshold, at which time a soft-start cycle begins.

The MAX755 operates with supply voltages greater than +2.7V. It does not have the undervoltage lockout feature of the MAX735. The output is limited to $I_{VOUT1} \leq 11.7V - V_{IN}$.

Inductor Selection

The MAX735 and MAX755 operate with a standard 10μH inductor for the entire range of supply voltages and load currents. The inductor must have a saturation (incremental) current rating greater than the peak switch current obtained from the Peak Inductor Current vs. Load Current graph under *Typical Operating Characteristics*.

Output Adjustment - MAX755

The output voltage for the MAX755 is set by two resistors, R3 and R4, which form a voltage divider between the output, CC pin, and VREF pin. The regulator adjusts the output voltage so the voltage at CC is GND. R3 can be any value from 10kΩ to 20kΩ. R4 is given by the following formula:

$$R4 = \frac{|V_{OUT}|}{1.23V} R3$$

The output is limited to $I_{VOUT1} \leq 11.7V - V_{IN}$.

Table 1. Component Suppliers

PRODUCTION METHOD	INDUCTORS	CAPACITORS
Surface Mount	Sumida CD54-100 (10μH)	Matsuo 267 series
Miniature Through Hole	Sumida RCH855-100M (10μH)	Sanyo Os-Con series low-ESR organic semiconductor
Low-Cost Through Hole	Renco RL 1284 (10μH)	Nichicon PL series low-ESR electrolytics United Chemicon LXF series

Matsuo USA (714) 969-2491 FAX (714) 960-6492
 Matsuo Japan (06) 332-0871
 Nichicon (708) 843-7500 FAX (708) 843-2798
 Renco (516) 586-5566 FAX (516) 586-5562
 Sanyo Os-Con USA (619) 661-6322
 Sanyo Os-Con Japan (0720) 70-1005 FAX (0720) 70-1174
 Sumida USA (708) 956-0666
 Sumida Japan (03) 3607-5111 FAX (03) 3607-5428
 United Chemi-Con (708) 696-2000 FAX (708) 640-6311

Printed Circuit Layout and Grounding

Good layout and grounding practices will ensure low-noise, jitter-free operation. Minimize wire lengths in the high-current paths, especially the distance between the inductor and the return leads of the filter and bypass capacitors (C1 and C2). These high-current ground connections should be brought to a single common point (a "star" ground). Place a low-ESR bypass capacitor directly at V+ and GND. The use of sockets or wire-wrap boards is not recommended.

MAX735/MAX755

-5V/Adjustable, Negative-Output, Inverting, Current-Mode PWM Regulators

Chip Topography

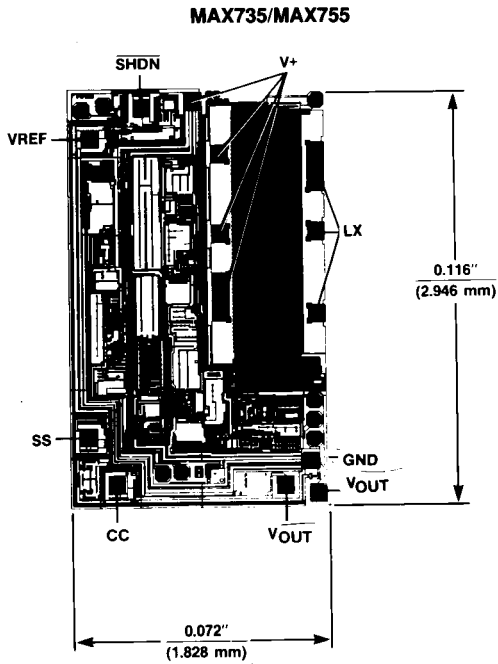

Note: TRANSISTOR COUNT: 274
CONNECT SUBSTRATE TO V+

Maxim cannot assume responsibility for use of any circuitry other than circuitry entirely embodied in a Maxim product. No circuit patent licenses are implied. Maxim reserves the right to change the circuitry and specifications without notice at any time.

8 **Maxim Integrated Products, 120 San Gabriel Drive, Sunnyvale, CA 94086 (408) 737-7600**

© 1994 Maxim Integrated Products

Printed USA

MAXIM is a registered trademark of Maxim Integrated Products.

Looking for pricing, stock, or lifecycle information?

Click below to explore more details on WIN SOURCE:

 [View MAX755ESA-T on WIN SOURCE](#)

 [Maxim Integrated](#) Information

Optimize Your Supply Chain with WIN SOURCE Solutions

-  Global Sourcing Solution
-  Obsolete Management
-  Cost Control Management
-  Shortage Management
-  Alternative Solution
-  Excess Inventory Management