



**THE DATASHEET OF
MAX8559EBAJJ+T**



EVALUATION KIT
AVAILABLE

MAXIM

Dual, 300mA, Low-Noise Linear Regulator with Independent Shutdown in UCSP or TDFN

General Description

The MAX8559 dual, low-noise, low-dropout (LDO) linear regulator operates from a 2.5V to 6.5V input voltage and delivers at least 300mA of continuous output current. It offers low output noise and low dropout of only 60mV at 100mA. Typical output noise for this device is 32 μ V_{RMS}, and PSRR is 70dB at 10kHz. Designed with an internal P-channel MOSFET pass transistor, the MAX8559 maintains a low 115 μ A supply current per LDO, independent of the load current and dropout voltage. Other features include short-circuit protection and thermal-shutdown protection. The MAX8559 includes two independent logic-controlled shutdown inputs and is capable of operating without a bypass capacitor to further reduce total solution size. The MAX8559 is available in a miniature 8-bump UCSP™ (2mm x 1mm) or 8-pin TDFN (3mm x 3mm) package.

Applications

Cellular and Cordless Phones
PDAs and Palmtop Computers
Notebook Computers
Digital Cameras
PCMCIA Cards
Wireless LAN Cards
Handheld Instruments

Typical Operating Circuit

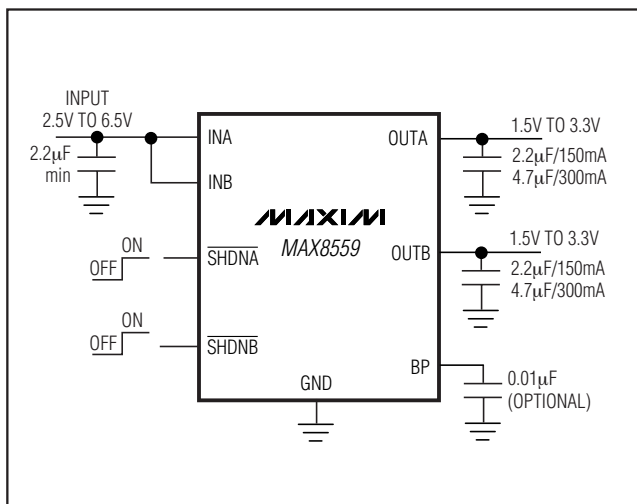

UCSP is a trademark of Maxim Integrated Products, Inc.
Output Voltage Selector Guide appears at end of data sheet.

Features

- ◆ Two Low-Dropout-Voltage Regulators
- ◆ Low 32 μ V_{RMS} Output Noise
- ◆ 300mA Output Current for Each LDO
- ◆ 70dB PSRR at 10kHz
- ◆ Independent Shutdown Controls
- ◆ Low 60mV Dropout at 100mA Load
- ◆ 115 μ A Operating Supply Current per LDO
- ◆ 1.5V to 3.3V Factory-Preset Output
- ◆ Small Ceramic Output Capacitors
- ◆ Output Current Limit
- ◆ Thermal-Overload and Short-Circuit Protection
- ◆ 1.95W Power-Dissipation Capability (TDFN)
- ◆ 2mm² Footprint (UCSP)

Ordering Information

PART	TEMP RANGE	PIN-PACKAGE
MAX8559EBAxy*-T	-40°C to +85°C	8 UCSP (B8-1)
MAX8559EBAxy*+T	-40°C to +85°C	8 UCSP (B8-1)
MAX8559ETAxy*-T	-40°C to +85°C	8 TDFN-EP**
MAX8559ETAxy*+T	-40°C to +85°C	8 TDFN-EP**

*xy = Output voltage code (see the Output Voltage Selector Guide).

**EP = Exposed pad.

+Denotes lead-free package.

Pin Configurations

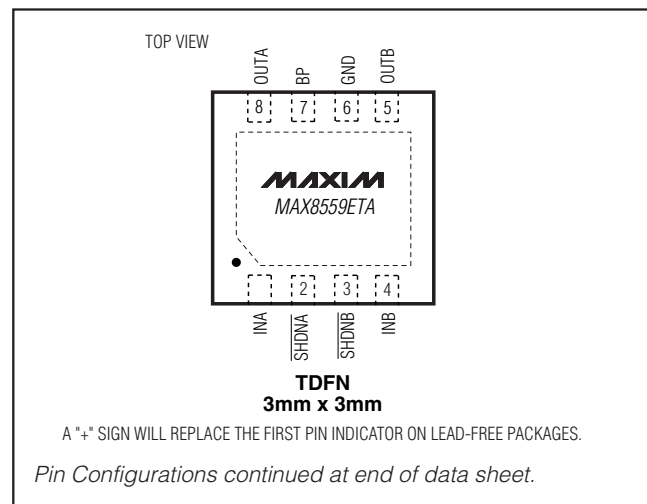

MAXIM

Maxim Integrated Products 1

For pricing, delivery, and ordering information, please contact Maxim/Dallas Direct! at 1-888-629-4642, or visit Maxim's website at www.maxim-ic.com.

MAX8559

Dual, 300mA, Low-Noise Linear Regulator with Independent Shutdown in UCSP or TDFN

ABSOLUTE MAXIMUM RATINGS

INA, INB, $\overline{\text{SHDN}}_A$, $\overline{\text{SHDN}}_B$, BP to GND-0.3V to +7V
 INA to INB.....-0.3V to +0.3V
 OUTA, OUTB to GND-0.3V to ($V_{IN} + 0.3V$)
 Output Short-Circuit Duration.....Continuous
 Continuous Power Dissipation ($T_A = +70^\circ\text{C}$)
 8-Bump UCSP (derate 4.7mW/ $^\circ\text{C}$ above +70 $^\circ\text{C}$).....379mW
 8-Pin TDFN (derate 24.4mW/ $^\circ\text{C}$ above +70 $^\circ\text{C}$)1951mW

Operating Temperature Range-40 $^\circ\text{C}$ to +85 $^\circ\text{C}$
 Junction Temperature+150 $^\circ\text{C}$
 Storage Temperature Range-65 $^\circ\text{C}$ to +150 $^\circ\text{C}$
 8-Pin TDFN Lead Temperature (soldering, 10s).....+300 $^\circ\text{C}$
 8-Bump UCSP Solder Profile.....(Note 1)

Note 1: For UCSP solder profile information, please refer to the application note APP_1891 on the Maxim website, www.maxim-ic.com.

Stresses beyond those listed under "Absolute Maximum Ratings" may cause permanent damage to the device. These are stress ratings only, and functional operation of the device at these or any other conditions beyond those indicated in the operational sections of the specifications is not implied. Exposure to absolute maximum rating conditions for extended periods may affect device reliability.

ELECTRICAL CHARACTERISTICS

($V_{IN} = 3.8V$, $\overline{\text{SHDN}}_A = \overline{\text{SHDN}}_B = \text{IN}_-$, $T_A = -40^\circ\text{C}$ to +85 $^\circ\text{C}$, unless otherwise noted. Typical values are at $T_A = +25^\circ\text{C}$.) (Note 1)

PARAMETER	SYMBOL	CONDITIONS	MIN	TYP	MAX	UNITS
Input Voltage	V_{IN}		2.5		6.5	V
Undervoltage-Lockout Threshold	V_{UVLO}	V_{IN} rising, hysteresis is 40mV (typ)	2.15	2.35	2.45	V
Output Voltage Accuracy		$T_A = +25^\circ\text{C}$, $I_{OUTA} = I_{OUTB} = 1\text{mA}$	-1		+1	%
		$T_A = -40^\circ\text{C}$ to +85 $^\circ\text{C}$, $I_{OUTA} = I_{OUTB} = 1\text{mA}$	-2		+2	
		$T_A = -40^\circ\text{C}$ to +85 $^\circ\text{C}$, I_{OUTA} or $I_{OUTB} = 0.1\text{mA}$ to 300mA	-3		+3	
Maximum Output Current	$I_{OUT_}$		300			mA
Output Current Limit	$I_{LIM_}$		310	550	920	mA
Ground Current	I_Q	No load		180	290	μA
		No load, one LDO shutdown		115		
		$I_{OUTA} = I_{OUTB} = 100\text{mA}$		220		
Dropout Voltage (Note 2)	$V_{OUT_} - V_{IN_}$	$I_{OUT_} = 1\text{mA}$		0.6		mV
		$I_{OUT_} = 100\text{mA}$		60	120	
Line Regulation	ΔV_{LNR}	$V_{IN_} = (V_{OUT_} + 0.1V)$ to 6.5V, $I_{OUT_} = 1\text{mA}$	-0.15	0	+0.15	%/V
Output Voltage Noise		100Hz to 100kHz, $C_{OUT_} = 10\mu\text{F}$, $I_{OUT_} = 1\text{mA}$, $C_{BP} = 0.01\mu\text{F}$		32		μVRMS
		100Hz to 100kHz, $C_{OUT_} = 10\mu\text{F}$, $I_{OUT_} = 1\text{mA}$, $C_{BP} = \text{not installed}$		254		
Power-Supply Ripple Rejection	PSRR	$V_{IN_} = V_{OUT_} + 1V$, $C_{BP} = 0.01\mu\text{F}$, $C_{OUT_} = 2.2\mu\text{F}$, $I_{OUT_} = 50\text{mA}$	10kHz		70	dB
			100kHz		54	
SHUTDOWN						
Shutdown Supply Current	I_{SHDN}	$\overline{\text{SHDN}}_ = 0V$	$T_A = +25^\circ\text{C}$	0.01	1	μA
			$T_A = -40^\circ\text{C}$ to +85 $^\circ\text{C}$	0.1		
$\overline{\text{SHDN}}$ Input Threshold	V_{IH}	Input high voltage	1.6			V
	V_{IL}	Input low voltage			0.4	

Dual, 300mA, Low-Noise Linear Regulator with Independent Shutdown in UCSP or TDFN

MAX8559

ELECTRICAL CHARACTERISTICS (continued)

($V_{IN} = 3.8V$, $\overline{SHDN_A} = \overline{SHDN_B} = IN_{-}$, $T_A = -40^{\circ}C$ to $+85^{\circ}C$, unless otherwise noted. Typical values are at $T_A = +25^{\circ}C$.) (Note 1)

PARAMETER	SYMBOL	CONDITIONS	MIN	TYP	MAX	UNITS
\overline{SHDN} Input Bias Current	I_{SHDN}	$\overline{SHDN_{-}} = IN$ or GND	$T_A = +25^{\circ}C$	10	100	nA
			$T_A = -40^{\circ}C$ to $+85^{\circ}C$	100		
V_{OUT} Discharge Resistance in Shutdown		$\overline{SHDN_{-}} = GND$		385		Ω
THERMAL PROTECTION						
Thermal-Shutdown Temperature	T_{SHDN}	T_J rising		+160		$^{\circ}C$
Thermal-Shutdown Hysteresis	ΔT_{SHDN}			10		$^{\circ}C$

Note 1: All units are 100% production tested at $T_A = +25^{\circ}C$. Limits over the operating temperature range are guaranteed by design.

Note 2: The dropout voltage is defined as $V_{IN} - V_{OUT}$ when V_{OUT} is 100mV below the nominal value of V_{OUT} . Specification only applies when $V_{OUT} \geq 2.5V$.

Typical Operating Characteristics

($V_{OUTA} = V_{OUTB} = 2.85V$, $V_{INA} = V_{INB} = 3.8V$, $C_{OUT} = 2.2\mu F$ (or $4.7\mu F$ for 300mA), $C_{BP} = 0.01\mu F$, and $C_{IN} = 2.2\mu F$ (or $4.7\mu F$ for 300mA), unless otherwise noted.)

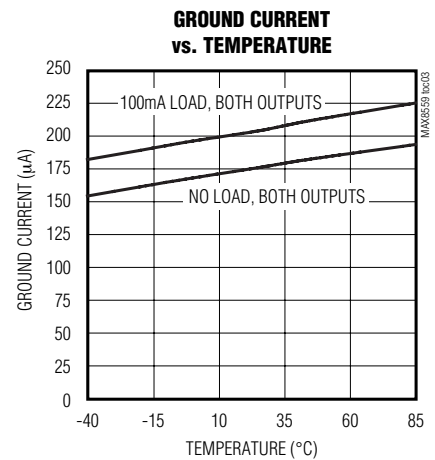
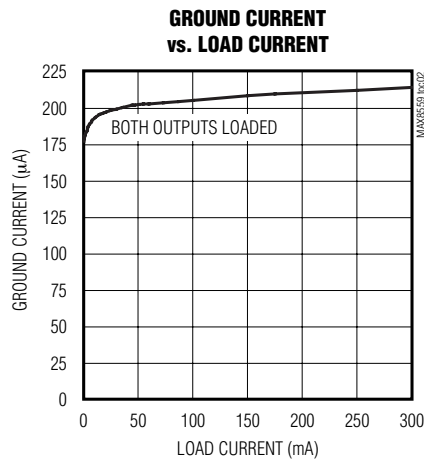
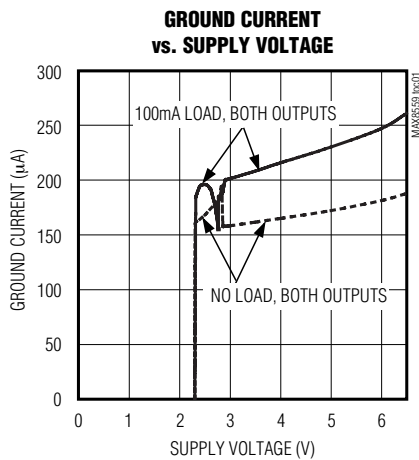

Dual, 300mA, Low-Noise Linear Regulator with Independent Shutdown in UCSP or TDFN

Typical Operating Characteristics (continued)

($V_{OUTA} = V_{OUTB} = 2.85V$, $V_{INA} = V_{INB} = 3.8V$, $C_{OUT} = 2.2\mu F$ (or $4.7\mu F$ for 300mA), $C_{BP} = 0.01\mu F$, and $C_{IN} = 2.2\mu F$ (or $4.7\mu F$ for 300mA), unless otherwise noted.)

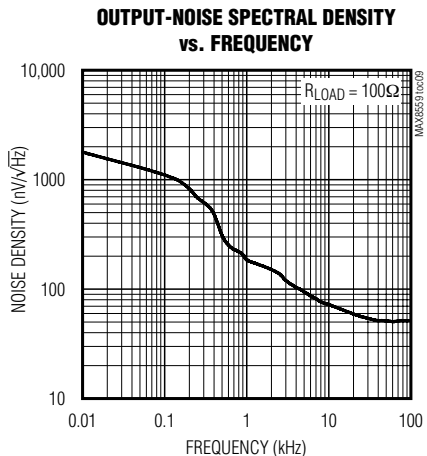
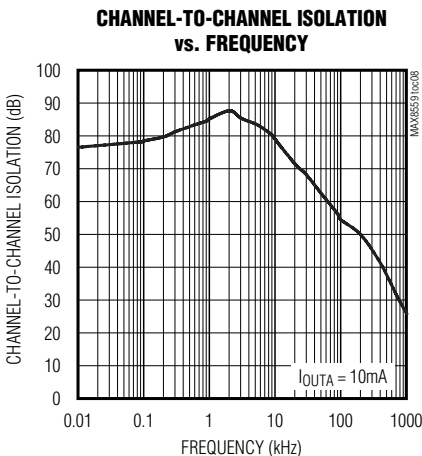
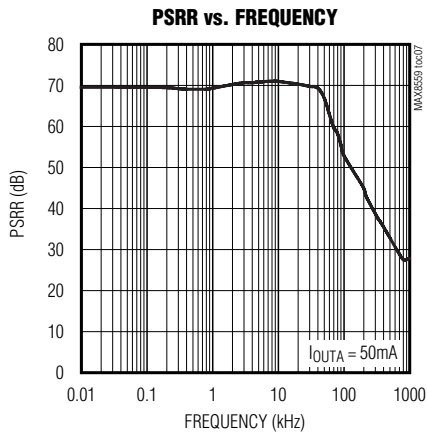
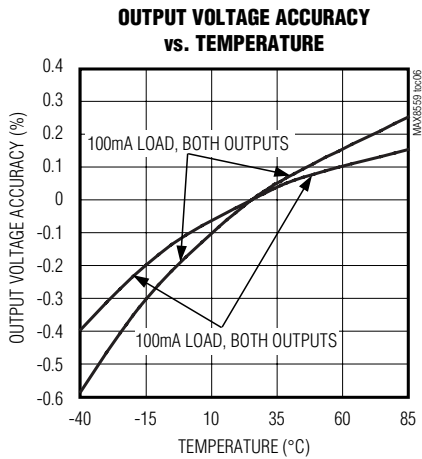
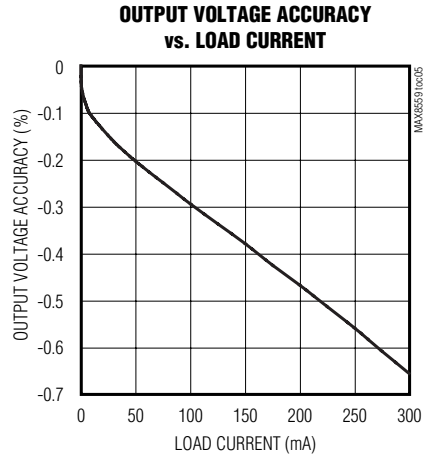
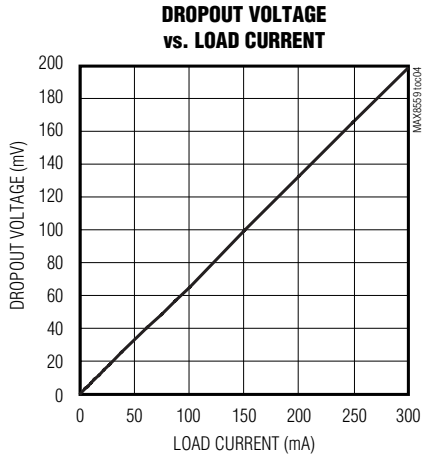

Dual, 300mA, Low-Noise Linear Regulator with Independent Shutdown in UCSP or TDFN

MAX8559

Typical Operating Characteristics (continued)

($V_{OUTA} = V_{OUTB} = 2.85V$, $V_{INA} = V_{INB} = 3.8V$, $C_{OUT} = 2.2\mu F$ (or $4.7\mu F$ for 300mA), $C_{BP} = 0.01\mu F$, and $C_{IN} = 2.2\mu F$ (or $4.7\mu F$ for 300mA), unless otherwise noted.)

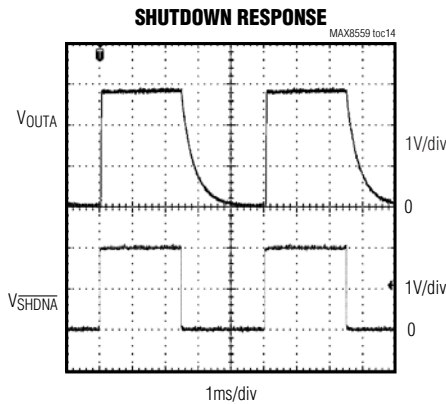
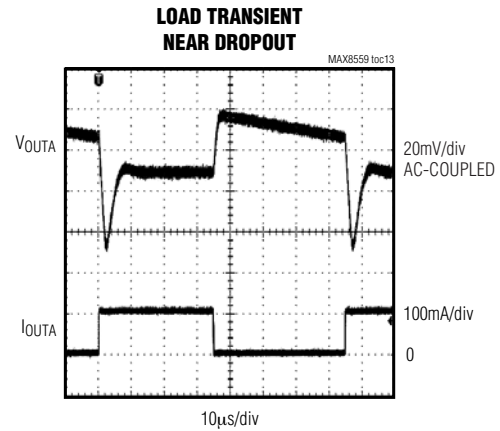
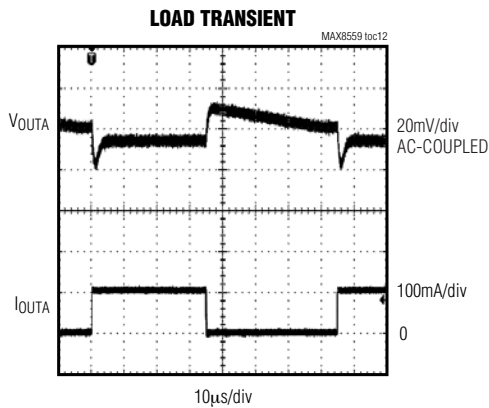
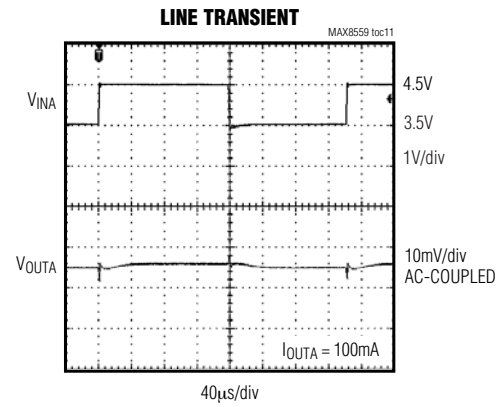
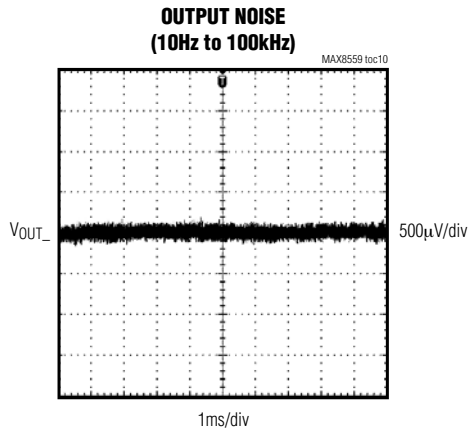

Dual, 300mA, Low-Noise Linear Regulator with Independent Shutdown in UCSP or TDFN

Pin Description

PIN		NAME	FUNCTION
TDFN	UCSP		
1	A1	INA	LDO A Regulator Input. Connect to INB. Input voltage can range from 2.5V to 6.5V. Bypass INA with a ceramic capacitor to GND (see the <i>Capacitor Selection and Regulator Stability</i> section).
2	A2	$\overline{\text{SHDNA}}$	Shutdown A Input. A logic-low on $\overline{\text{SHDNA}}$ shuts down regulator A. If $\overline{\text{SHDNA}}$ and $\overline{\text{SHDNB}}$ are both low, both regulators and the internal reference are off and the supply current is reduced to 10nA (typ). If either $\overline{\text{SHDNA}}$ or $\overline{\text{SHDNB}}$ is a logic high, the internal reference is on. Connect $\overline{\text{SHDNA}}$ to INA for always-on operation of regulator A.
3	A3	$\overline{\text{SHDNB}}$	Shutdown B Input. A logic-low on $\overline{\text{SHDNB}}$ shuts down regulator B. If $\overline{\text{SHDNA}}$ and $\overline{\text{SHDNB}}$ are both low, both regulators and the internal reference are off and the supply current is reduced to 10nA (typ). If either $\overline{\text{SHDNA}}$ or $\overline{\text{SHDNB}}$ is a logic high, the internal reference is on. Connect $\overline{\text{SHDNB}}$ to INB for always-on operation of regulator B.
4	A4	INB	LDO B Regulator Input. Connect to INA. Input voltage can range from 2.5V to 6.5V. Bypass INB with a ceramic capacitor to GND (see the <i>Capacitor Selection and Regulator Stability</i> section).
5	B4	OUTB	Regulator B Output. OUTB can source up to 300mA continuous current. Bypass OUTB with a ceramic capacitor to GND (see the <i>Capacitor Selection and Regulator Stability</i> section). During shutdown, OUTB is internally discharged to GND through a 385 Ω resistor.
6	B3	GND	Ground
7	B2	BP	Reference Noise Bypass. Bypass BP with a low-leakage 0.01 μ F ceramic capacitor for reduced noise at both outputs.
8	B1	OUTA	Regulator A Output. OUTA can source up to 300mA continuous current. Bypass OUTA with a ceramic capacitor to GND (see the <i>Capacitor Selection and Regulator Stability</i> section). During shutdown, OUTB is internally discharged to GND through a 385 Ω resistor.
EP	—	Exposed Paddle	Connect to ground plane. EP also functions as a heatsink. Solder to the circuit-board ground plane to maximize thermal dissipation.

Detailed Description

The MAX8559 is a dual, low-noise, low-dropout, low-quiescent-current linear regulator designed primarily for battery-powered applications. The regulators are available with preset 1.5V to 3.3V output voltages. These outputs can supply loads up to 300mA with a 4.7 μ F output capacitor, or up to 150mA with a 2.2 μ F output capacitor. As illustrated in the *Functional Diagram*, the MAX8559 consists of a 1.25V reference, error amplifiers, P-channel pass transistors, internal feedback voltage-dividers, and autodischarge circuitry.

Feedback Control Loop

The 1.25V bandgap reference is connected to the error amplifier's inverting input. The error amplifier compares this reference with the feedback voltage and amplifies the difference. If the feedback voltage is lower than the reference voltage, the pass-transistor gate is pulled

lower, allowing more current to pass to the output and increasing the output voltage. If the feedback voltage is too high, the pass-transistor gate is pulled up, allowing less current to pass to the output. The output voltage is fed back through an internal resistor voltage-divider connected to OUT_{_}.

Internal P-Channel Pass Transistor

The MAX8559 features two 0.6 Ω P-channel MOSFET pass transistors. A P-channel MOSFET provides several advantages over similar designs using PNP pass transistors, including longer battery life. It requires no base drive, reducing quiescent current considerably. PNP-based regulators waste considerable current in dropout when the pass transistor saturates, and they also use high base-drive currents under large loads. The MAX8559 does not suffer from these problems, and with both outputs on it only consumes 180 μ A of

Dual, 300mA, Low-Noise Linear Regulator with Independent Shutdown in UCSP or TDFN

quiescent current at no load and 220 μ A with 100mA load current on both outputs (see the *Typical Operating Characteristics*). A PNP-based regulator has a high dropout voltage that is independent of the load. A P-channel MOSFET's dropout voltage is proportional to load current, providing for low dropout voltage at heavy loads and extremely low dropout at lighter loads.

Current Limit

The MAX8559 contains two independent current limiters, one for each regulator output, monitoring and controlling the pass transistor's gate voltage and limiting the output current to 310mA (min). The outputs can be shorted to ground continuously without damaging the part.

Low-Noise Operation

An external 0.01 μ F bypass capacitor at BP in conjunction with an internal resistor creates a lowpass filter. The MAX8559 exhibits less than 32 μ V_{RMS} of output voltage noise with C_{BP} = 0.01 μ F and C_{OUT} = 10 μ F. The *Typical Operating Characteristics* show a graph of Output-Noise Spectral Density with these values. If output noise is not critical, the BP capacitor can be removed to reduce total solution size and cost.

Shutdown

The MAX8559 has independent shutdown control inputs (SHDNA and SHDNB). Drive SHDNA low to shut down OUTA. Drive SHDNB low to shut down OUTB. Drive both SHDNA and SHDNB low to shut down the entire chip, reducing supply current to 0.01 μ A. Connect SHDNA or SHDNB to a logic high or IN_ for always-on operation of the corresponding LDO. Each LDO output is internally discharged to ground through a 385 Ω resistor in shutdown mode.

Thermal-Overload Protection

Thermal-overload protection limits total power dissipation in the MAX8559. Each regulator has its own independent thermal detector. When one of the regulators' junction temperature exceeds T_J = +160°C, that regulator's pass transistor is turned off allowing the IC to cool. The thermal sensor turns the pass transistor on again after the IC's junction temperature cools by 10°C. This results in a pulsed output during continuous thermal-overload conditions.

Operating Region and Power Dissipation

The MAX8559 maximum power dissipation depends on the thermal resistance of the case and the circuit board, the temperature difference between the die junction and ambient air, and the rate of airflow. The power dissipation across the device is P = I_{OUT} x (V_{IN} - V_{OUT}).

The maximum power dissipation allowed is:

$$P_{MAX} = (T_J - T_A) / (R_{\theta JB} + R_{\theta BA})$$

where T_J - T_A is the temperature difference between the MAX8559 die junction and the surrounding air, R _{θ JB} (R _{θ JC}) is the thermal resistance of the package, and R _{θ BA} is the thermal resistance through the printed circuit board, copper traces, and other materials to the surrounding air.

The exposed paddle of the TDFN package performs the function of channeling heat away. Connect the exposed paddle to the board ground plane.

Applications Information

Capacitor Selection and Regulator Stability

For load currents up to 150mA, use a single 2.2 μ F capacitor to bypass both inputs of the MAX8559 and a 2.2 μ F capacitor to bypass each output. Larger input-capacitor values and lower ESRs provide better supply-noise rejection and line-transient response. To reduce output noise and improve load-transient voltage dips, use larger output capacitors up to 10 μ F. For stable operation over the full temperature range with load currents up to 300mA, input and output capacitors should be a minimum of 4.7 μ F.

Note that some ceramic dielectrics exhibit large capacitance and ESR variation with temperature. With dielectrics such as Z5U and Y5V, it may be necessary to use 4.7 μ F or more for up to 150mA load current to ensure stability at temperatures below -10°C. With X7R or X5R dielectrics, 2.2 μ F is sufficient at all operating temperatures. These regulators are optimized for ceramic capacitors. Tantalum capacitors are not recommended.

Use a 0.01 μ F bypass capacitor at BP for low-output voltage noise. Increasing the capacitance slightly decreases the output noise, but increases the startup time.

PSRR and Operation from Sources Other than Batteries

The MAX8559 is designed to deliver low-dropout voltages and low quiescent currents in battery-powered systems. Power-supply rejection ratio is 70dB at 10kHz (see Power-Supply Rejection Ratio vs. Frequency in the *Typical Operating Characteristics*). When operating from sources other than batteries, improved supply-noise rejection and transient response is achieved by increasing the values of the input and output bypass capacitors and through passive RC or CRC filtering techniques.

Dual, 300mA, Low-Noise Linear Regulator with Independent Shutdown in UCSP or TDFN

Load-Transient Considerations

The MAX8559 load-transient response graphs (see the *Typical Operating Characteristics*) show two components of the output response: a DC shift in the output voltage due to the different load currents and the transient response. Typical overshoot for step changes in the load current from 10 μ A to 100mA is 15mV. Increase the output capacitor's value and decrease its ESR to attenuate transient spikes.

Dropout Voltage

A regulator's minimum input-output voltage differential (or dropout voltage) determines the lowest usable supply voltage. In battery-powered systems, this determines the useful end-of-life battery voltage. Because the MAX8559 uses an internal P-channel MOSFET pass transistor, its dropout voltage is a function of the drain-to-source on-resistance ($R_{DS(ON)}$) multiplied by the load current (see the *Typical Operating Characteristics*).

Calculating the Maximum Output Power in UCSP

The maximum output power of the MAX8559 is limited by the maximum power dissipation of the package. By calculating the power dissipation of the package as a function of the input voltage, output voltages, and output currents, the maximum input voltage can be obtained. The maximum power dissipation should not exceed the package's maximum power rating.

$$P = (V_{IN(MAX)} - V_{OUTA}) \times I_{OUTA} + (V_{IN(MAX)} - V_{OUTB}) \times I_{OUTB}$$

where:

$V_{IN(MAX)}$ = maximum input voltage

P_{MAX} = maximum power dissipation of the package (379mW for the UCSP and 1951mW for the TDFN)

V_{OUTA} = output voltage of OUTA

V_{OUTB} = output voltage of OUTB

I_{OUTA} = maximum output current of OUTA

I_{OUTB} = maximum output current of OUTB

P should be less than P_{MAX} . If P is greater than P_{MAX} , consider the TDFN.

Layout Guidelines

Due to the low output noise and tight output voltage accuracy required by most applications, careful PC board layout is required. An evaluation kit (MAX8559EVKIT) is available to speed design.

Follow these guidelines for good PC board layout:

- Keep the input and output paths short and wide if possible, especially at the ground terminals.
- Use thick copper PC boards (2oz vs. 1oz) to enhance thermal capabilities.
- Place output, input, and bypass capacitors as close as possible to the IC.
- Ensure traces to BP and the BP capacitor are away from noisy sources to ensure low output voltage noise.

Dual, 300mA, Low-Noise Linear Regulator with Independent Shutdown in UCSP or TDFN

Functional Diagram

MAX8559

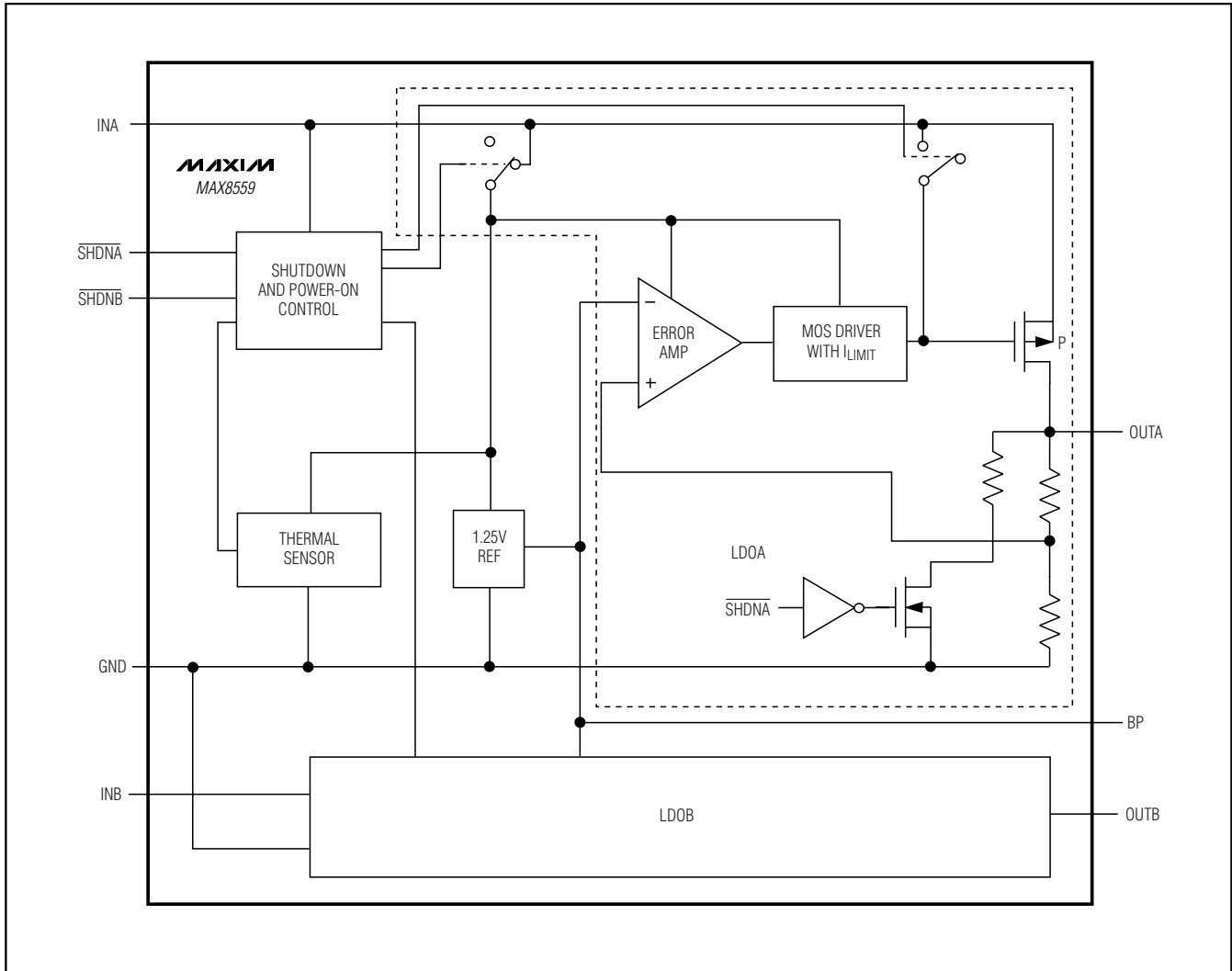

Dual, 300mA, Low-Noise Linear Regulator with Independent Shutdown in UCSP or TDFN

Output Voltage Selector Guide

PART	V _{OUTA} (x)	V _{OUTB} (y)	TOP MARK
MAX8559EBA8A	1.50	3.30	AAE
MAX8559EBA2G	1.80	3.00	AAF
MAX8559EBA11	1.85	1.85	AAK
MAX8559EBAP2	2.50	1.80	AAG
MAX8559EBAK2	2.80	1.80	AAH
MAX8559EBAJJ	2.85	2.85	AAC
MAX8559EBAJG	2.85	3.00	AAI
MAX8559EBAIL	2.90	2.90	AAB
MAX8559EBAG2	3.00	1.80	AAJ
MAX8559EBAGJ	3.00	2.85	AAD
MAX8559EBAGG	3.00	3.00	AAA
MAX8559EBAAA	3.30	3.30	AAL
MAX8559ETA88	1.50	1.50	AOL
MAX8559ETA8A	1.50	3.30	AIM
MAX8559ETA22	1.80	1.80	API
MAX8559ETA2G	1.80	3.00	ALK
MAX8559ETA11	1.85	1.85	AOV
MAX8559ETAP2	2.50	1.80	ALL
MAX8559ETA01	2.60	1.85	APJ
MAX8559ETAK2	2.80	1.80	ALM
MAX8559ETAKG	2.80	3.00	AIN
MAX8559ETAJ2	2.85	1.80	ALD
MAX8559ETAJJ	2.85	2.85	AIG
MAX8559ETAJG	2.85	3.00	ALN
MAX8559ETAIL	2.90	2.90	AIF
MAX8559ETAG2	3.00	1.80	ALO
MAX8559ETAGG	3.00	3.00	AIE
MAX8559ETAAO	3.30	2.60	APK
MAX8559ETAAJ	3.30	2.85	AOM
MAX8559ETAAA	3.30	3.30	APD

Note: Standard output voltage options, shown in bold, are available. Contact the factory for other output voltages between 1.5V and 3.3V. Minimum order quantity is 15,000 units.

Pin Configurations (continued)

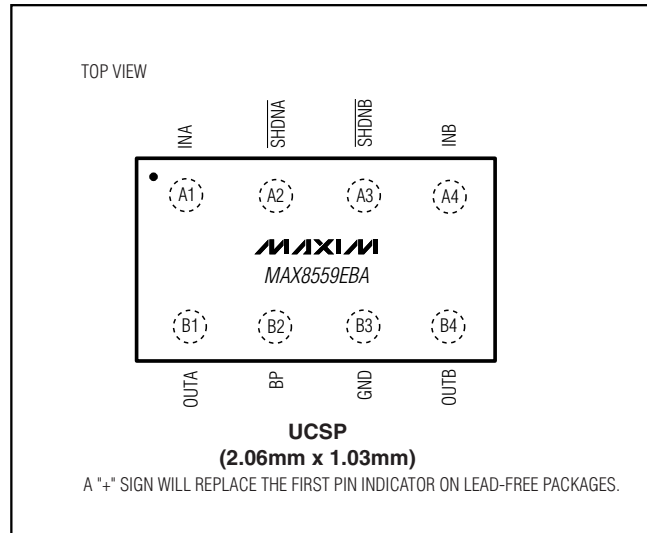

Chip Information

TRANSISTOR COUNT: 634

PROCESS: BiCMOS

Dual, 300mA, Low-Noise Linear Regulator with Independent Shutdown in UCSP or TDFN

Package Information

(The package drawing(s) in this data sheet may not reflect the most current specifications. For the latest package outline information, go to www.maxim-ic.com/packages.)

MAX8559

TOP VIEW

COMMON DIMENSIONS	
A	0.62±0.05-0.08
A1	0.29±0.02
A2	0.33 REF.
b	∅0.35±0.03
D1	0.50 BASIC
E1	1.50 BASIC
e	0.50 BASIC
SD	0.25 BASIC
SE	0.25 BASIC

PKG. CODE	VARIABLE DIMENSIONS		DEPOPULATED SOLDER BALLS
	D	E	
BB-1	1.02±0.05	2.02±0.05	NONE

NOTES:

- ALL DIMENSIONS ARE IN MILLIMETERS.
- PRODUCT MARKING: NUMBER OF CHARACTERS AND LINES VARY PER PRODUCT.

BOTTOM VIEW

SIDE VIEW

	DALLAS SEMICONDUCTOR	MAXIM
PROPRIETARY INFORMATION		
TITLE		
PACKAGE OUTLINE, 4x2 UCSP		
APPROVAL	DOCUMENT CONTROL NO.	REV.
	21-0156	A 1/1

UCSP 4x2.EPS

Looking for pricing, stock, or lifecycle information?

Click below to explore more details on WIN SOURCE:

 [View MAX8559EBAJJ+T on WIN SOURCE](#)

 [Maxim Integrated](#) Information

Optimize Your Supply Chain with WIN SOURCE Solutions

-  Global Sourcing Solution
-  Obsolete Management
-  Cost Control Management
-  Shortage Management
-  Alternative Solution
-  Excess Inventory Management