



**THE DATASHEET OF
MAX864EEE+**





Dual-Output Charge Pump with Shutdown

MAX864

General Description

The MAX864 CMOS, charge-pump, DC-DC voltage converter produces a positive and a negative output from a single positive input, and requires only four capacitors. The charge pump first doubles the input voltage, then inverts the doubled voltage. The input voltage ranges from +1.75V to +6.0V.

The internal oscillator can be pin-programmed from 7kHz to 185kHz, allowing the quiescent current, capacitor size, and switching frequency to be optimized. The 55Ω output impedance permits useful output currents up to 20mA. The MAX864 also has a 1μA logic-controlled shutdown.

The MAX864 comes in a 16-pin QSOP package that uses the same board area as a standard 8-pin SOIC. For more space-sensitive applications, the MAX865 is available in an 8-pin μMAX package, which uses half the board area of the MAX864.

Applications

Low-Voltage GaAsFET Bias in Wireless Handsets
VCO and GaAsFET Supply
Split Supply from 2 to 4 Ni Cells or 1 Li+ Cell
Low-Cost Split Supply for Low-Voltage Data-Acquisition Systems
Split Supply for Analog Circuitry
LCD Panels

Pin Configuration

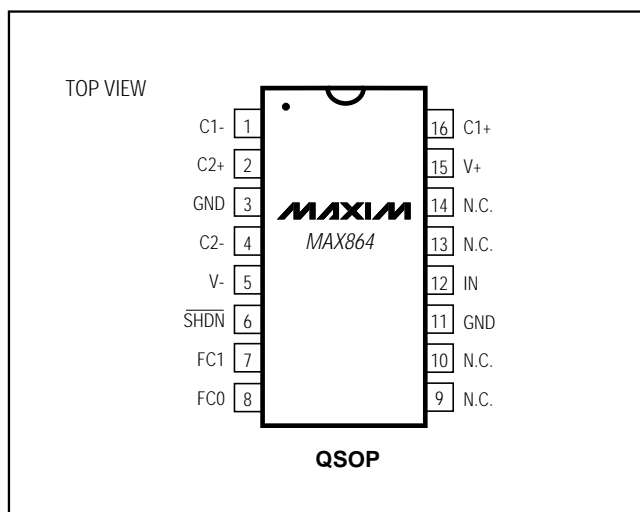

Features

- ◆ Requires Only Four Capacitors
- ◆ Dual Outputs (Positive and Negative)
- ◆ Low Input Voltages: +1.75V to +6.0V
- ◆ 1μA Logic-Controlled Shutdown
- ◆ Selectable Frequencies Allow Optimization of Capacitor Size and Supply Current

Ordering Information

PART	TEMP. RANGE	PIN-PACKAGE
MAX864C/D	0°C to +70°C	Dice*
MAX864EEE	-40°C to +85°C	16 QSOP

* Contact factory for dice specifications.

Typical Operating Circuit

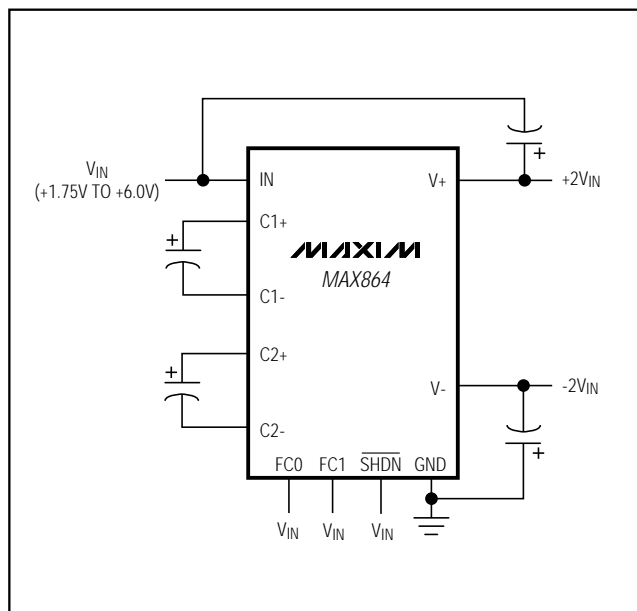

Dual-Output Charge Pump with Shutdown

ABSOLUTE MAXIMUM RATINGS

V+ to GND	-0.3V to +12V
SHDN, FC0, FC1 to GND	-0.3V to (V+ + 0.3V)
IN to GND	-0.3V to +6.2V
V- to GND	+0.3V to -12V
V- Output Current	100mA
V- Short Circuit to GND	Indefinite

Operating Temperature Range	
MAX864EEE	-40°C to +85°C
Continuous Power Dissipation (T _A = +70°C)	
QSOP (derate 8.70mW/°C above +70°C)	696mW
Storage Temperature Range	-65°C to +160°C
Lead Temperature (soldering, 10sec)	+300°C

Stresses beyond those listed under "Absolute Maximum Ratings" may cause permanent damage to the device. These are stress ratings only, and functional operation of the device at these or any other conditions beyond those indicated in the operational sections of the specifications is not implied. Exposure to absolute maximum rating conditions for extended periods may affect device reliability.

ELECTRICAL CHARACTERISTICS (Note 1)

(V_{IN} = 5V, $\overline{\text{SHDN}}$ = V_{IN}, circuit of Figure 1, T_A = T_{MIN} to T_{MAX}, unless otherwise noted. Typical values are at T_A = +25°C.)

PARAMETER	SYMBOL	MIN	TYP	MAX	UNITS
SUPPLY					
Minimum Start-Up Voltage	R _{LOAD} = 10kΩ	T _A = +25°C	1.75	1.25	V
		T _A = T _{MIN} to T _{MAX}	2.00		
Maximum Supply Voltage	R _{LOAD} = 10kΩ			6.0	V
Supply Current	FC1 = FC0 = GND, f = 7kHz		0.6	1.0	mA
	FC1 = GND, FC0 = IN, f = 33kHz		2.4	3.65	
	FC1 = IN, FC0 = GND, f = 100kHz		7	11	
	FC1 = FC0 = IN, f = 185kHz		12	18	
Shutdown Current	FC1 = FC0 = IN or GND, $\overline{\text{SHDN}}$ = GND		0.1	1	μA
Oscillator Frequency	FC1 = FC0 = GND	5	7	10	kHz
	FC1 = GND, FC0 = IN	24	33	48	
	FC1 = IN, FC0 = GND	70	100	140	
	FC1 = FC0 = IN	130	185	260	
INPUTS AND OUTPUTS					
Logic Input Low Voltage	$\overline{\text{SHDN}}$, FC0, FC1		2.2	1.0	V
Logic Input High Voltage	$\overline{\text{SHDN}}$, FC0, FC1	3.5	2.8		V
Logic Input Bias Current	$\overline{\text{SHDN}}$, FC0 = FC1 = GND or IN	-1		1	μA
V+ to IN Shutdown Resistance	I _{V+} = 10mA		22	100	Ω
V- to GND Shutdown Resistance	I _{V-} = 10mA		6	50	Ω
Output Resistance (Note 1)	I _{V+} = 10mA, I _{V-} = 0mA	T _A = +25°C	55	75	Ω
		T _A = T _{MIN} to T _{MAX}		100	
	V+ = 10V, I _{V-} = 10mA (forced)	T _A = +25°C	34	50	
		T _A = T _{MIN} to T _{MAX}		60	
Voltage Conversion Efficiency	V+, R _L = ∞	95	99		%
	V-, R _L = ∞	95	99		

Note 1: Measured using the capacitor values in Table 1. Capacitor ESR contributes approximately 10% of the output impedance [ESR + 1 / (pump frequency x capacitance)].

Dual-Output Charge Pump with Shutdown

Typical Operating Characteristics

($V_{IN} = 5.0V$, capacitor values in Table 1, $T_A = +25^\circ C$, unless otherwise noted.)

MAX864

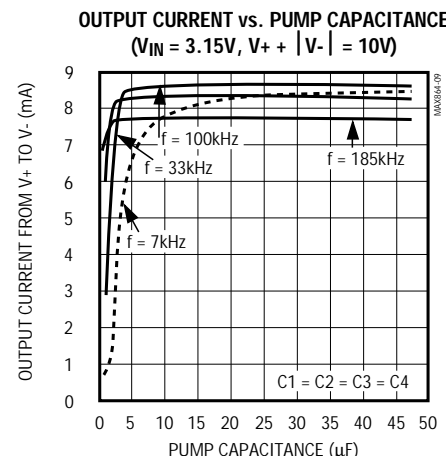
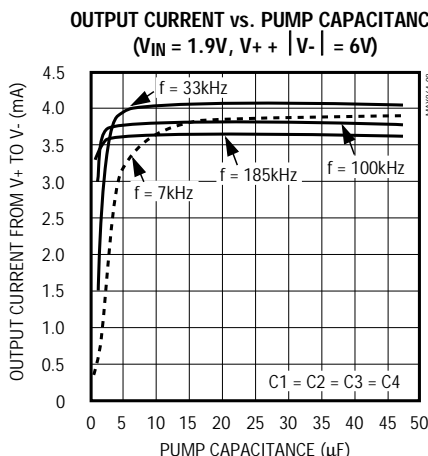
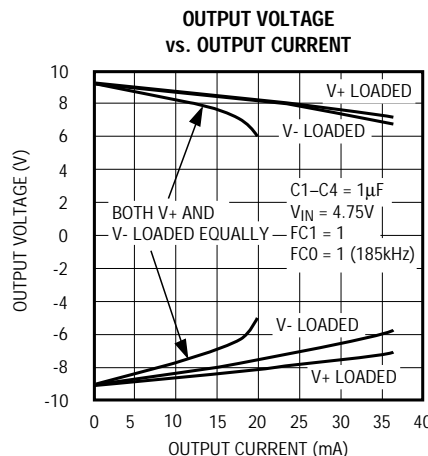
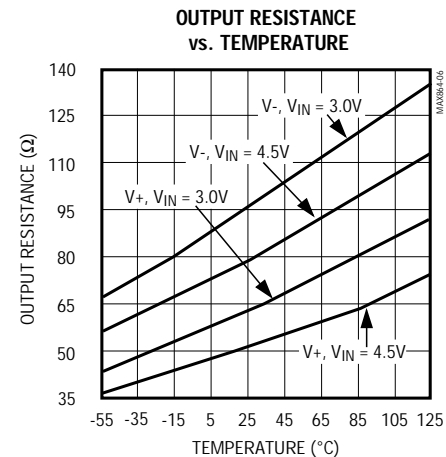
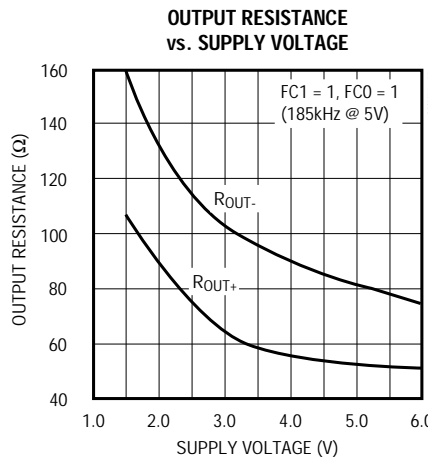
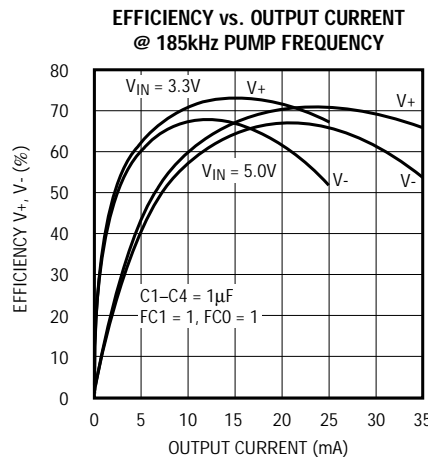
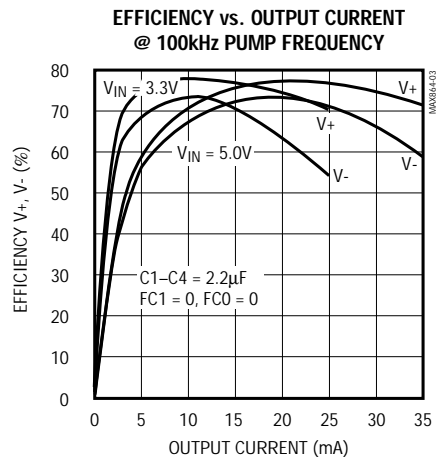
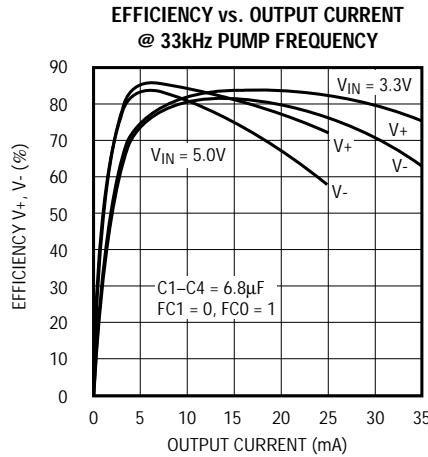
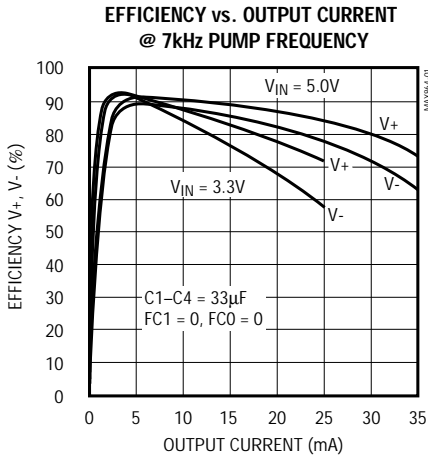

Dual-Output Charge Pump with Shutdown

Typical Operating Characteristics (continued)

($V_{IN} = 5.0V$, capacitor values in Table 1, $T_A = +25^\circ C$, unless otherwise noted.)

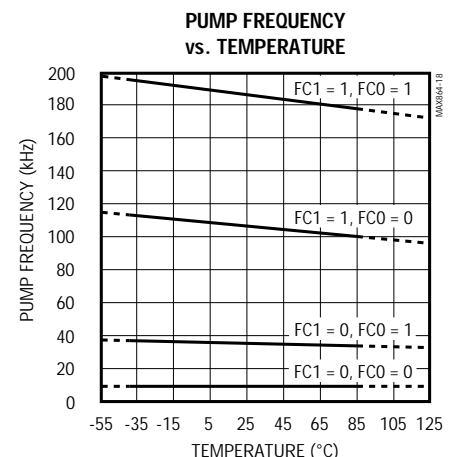
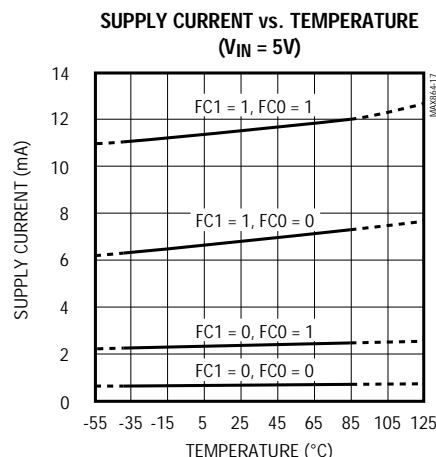
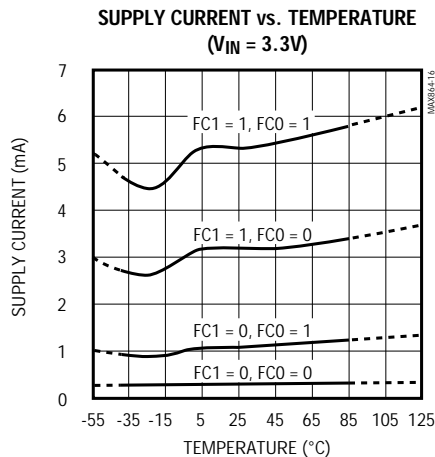
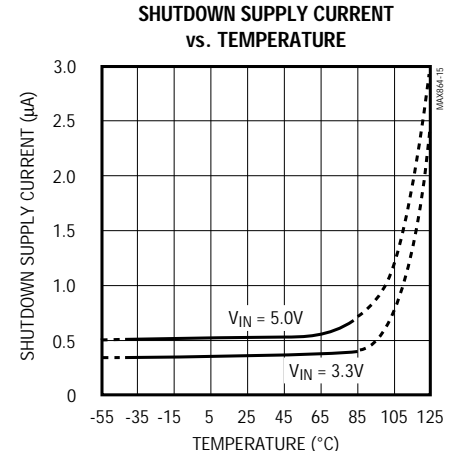
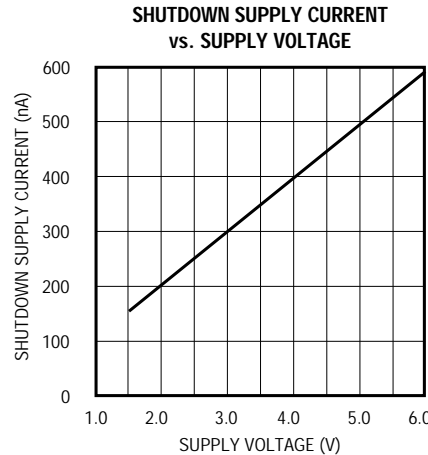
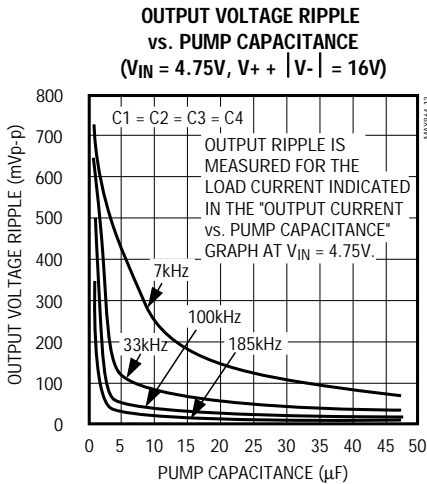
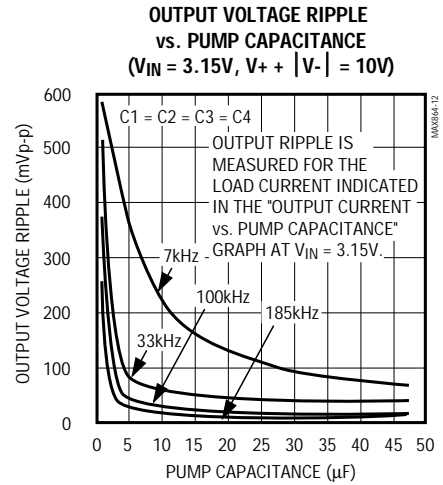
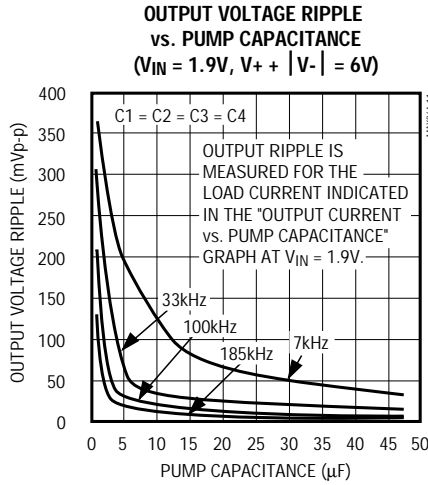
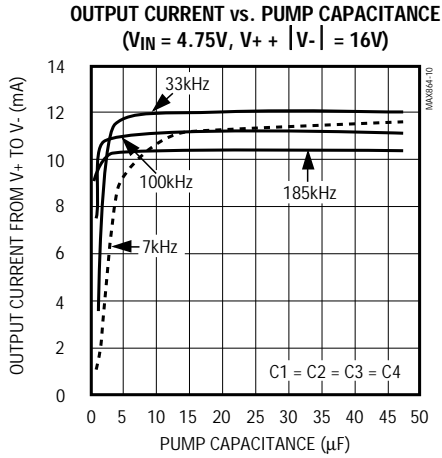

Dual-Output Charge Pump with Shutdown

MAX864

Typical Operating Characteristics (continued)

($V_{IN} = 5.0V$, capacitor values in Table 1, $T_A = +25^\circ C$, unless otherwise noted.)

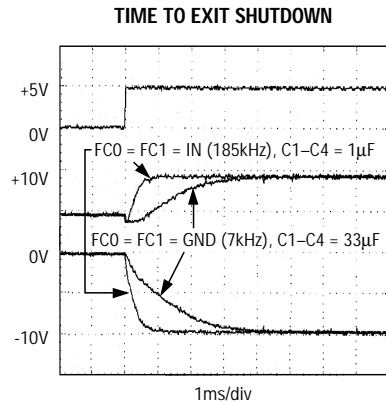

Pin Description

PIN	NAME	FUNCTION
1	C1-	Negative Terminal of the Flying Boost Capacitor
2	C2+	Positive Terminal of the Flying Inverting Capacitor
3, 11	GND	Ground (connect pins 3 and 11 together)
4	C2-	Negative Terminal of the Flying Inverting Capacitor
5	V-	Output of the Inverting Charge Pump
6	$\overline{\text{SHDN}}$	Active-Low Shutdown Input. With $\overline{\text{SHDN}}$ low, the part is in shutdown mode and its supply current is less than $1\mu A$. In shutdown mode, V+ connects to IN through a 22Ω switch, and V- connects to GND through a 6Ω switch.
7	FC1	Frequency Select, MSB (see Table 1)
8	FC0	Frequency Select, LSB (see Table 1)
9, 10, 13, 14	N.C.	No Connect—no internal connection. Connect these to ground to improve thermal dissipation.
12	IN	Positive Power-Supply Input
15	V+	Output of the Boost Charge Pump
16	C1+	Positive Terminal of the Flying Boost Capacitor

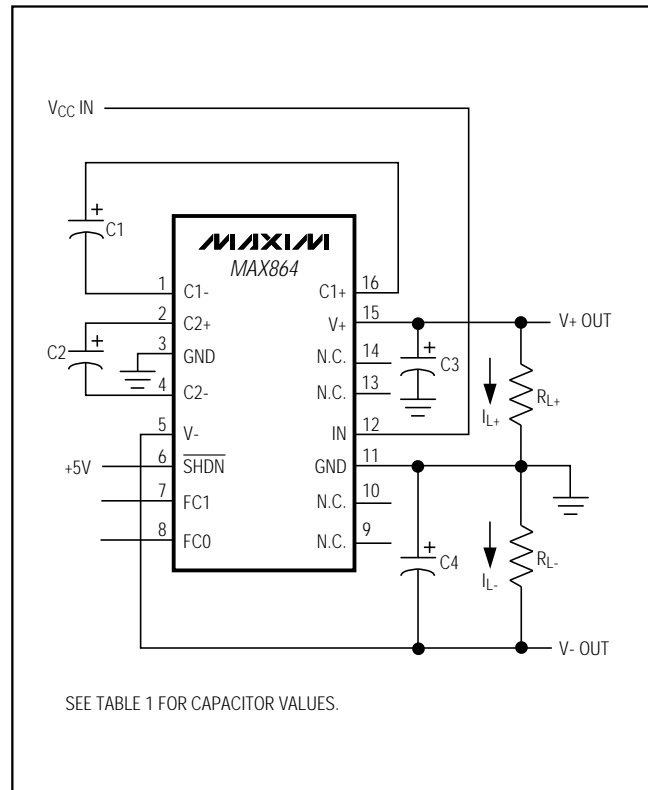

Figure 1. Test Circuit

Dual-Output Charge Pump with Shutdown

Detailed Description

The MAX864 requires only four external capacitors to implement a voltage doubler/inverter. These may be ceramic or polarized capacitors (electrolytic or tantalum) with values ranging from 0.47 μ F to 100 μ F.

Figure 2a illustrates the ideal operation of the positive voltage doubler. The on-chip oscillator generates a 50% duty-cycle clock signal. During the first half cycle, switches S2 and S4 open, switches S1 and S3 close, and capacitor C1 charges to the input voltage (V_{IN}). During the second half cycle, switches S1 and S3 open, switches S2 and S4 close, and capacitor C1 is level shifted upward by V_{IN} volts. Assuming ideal switches and no load on C3, charge transfers into C3 from C1 such that the voltage on C3 will be $2V_{IN}$, generating the positive supply output ($V+$).

Figure 2b illustrates the ideal operation of the negative converter. The switches of the negative converter are out of phase from the positive converter. During the second half cycle, switches S6 and S8 open, and switches S5 and S7 close, charging C2 from $V+$ (pumped up to $2V_{IN}$ by the positive charge pump) to GND. In the first half of the clock cycle, switches S5 and S7 open, switches S6 and S8 close, and the charge on capacitor C2 transfers to C4, generating the negative supply. The eight switches are CMOS power MOSFETs. Switches S1, S2, S4, and S5 are P-channel devices, while switches S3, S6, S7, and S8 are N-channel devices.

Charge-Pump Frequency and Capacitor Selection

The MAX864 offers four different charge-pump frequencies. To select a desired frequency, define pins FC0 and FC1 as shown in Table 1. Lower charge-pump frequencies produce lower average supply currents, while higher charge-pump frequencies require smaller capacitors.

Table 1 also lists the recommended charge-pump capacitor values for each pump frequency. Using values larger than those recommended will have little effect on the output current. Using values smaller than those recommended will reduce the available output current and increase the output ripple. To cut the output ripple in half, double the values of C3 and C4.

To maintain the lowest output resistance, use capacitors with low effective series resistance (ESR). At each switching frequency, the charge-pump output resistance is a function of C1, C2, C3, and C4's ESR. Minimizing the charge-pump capacitors' ESR minimizes output resistance. Use ceramic capacitors for best results.

Table 1. Frequency Selection

FC1	FC0	FREQUENCY (kHz)	CAPACITORS C1-C4 (μ F)
0	0	7	33
0	1	33	6.8
1	0	100	2.2
1	1	185	1

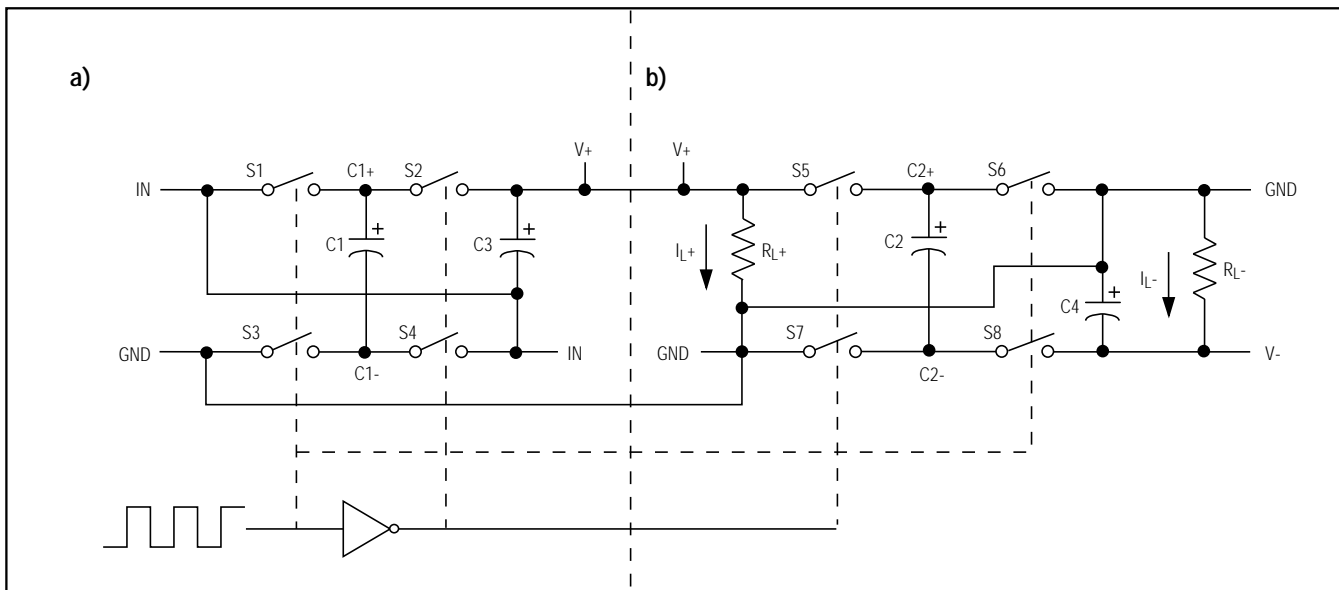

Figure 2. Idealized Voltage Quadrupler: a) Positive Charge Pump; b) Negative Charge Pump

Dual-Output Charge Pump with Shutdown

Charge-Pump Output

The MAX864 is not a voltage regulator: the output source resistance of either charge pump is approximately 55Ω at room temperature (with $V_{IN} = 5V$); and V_+ and V_- approach +10V and -10V, respectively, when lightly loaded. Both V_+ and V_- will droop toward GND as the current draw from either V_+ or V_- increases, since V_- is derived from V_+ . Treating each converter separately, the droop of the negative supply (V_{DROOP-}) is the product of the current draw from V_- (I_{V-}) and the source resistance of the negative converter (RS_-):

$$V_{DROOP-} = I_{V-} \times RS_-$$

The droop of the positive supply (V_{DROOP+}) is the product of the current draw from the positive supply (I_{LOAD+}) and the source resistance of the positive converter (RS_+), where I_{LOAD+} is the combination of I_{V-} and the external load on V_+ (I_{V+}):

$$V_{DROOP+} = I_{LOAD+} \times RS_+ = (I_{V+} + I_{V-}) \times RS_+$$

Determine V_+ and V_- as follows:

$$\begin{aligned} V_+ &= 2V_{IN} - V_{DROOP+} \\ V_- &= (V_+ - V_{DROOP-}) \\ &= -(2V_{IN} - V_{DROOP+} - V_{DROOP-}) \end{aligned}$$

The output resistances for the positive and negative charge pumps are tested and specified separately. The positive charge pump is tested with V_- unloaded. The negative charge pump is tested with V_+ supplied from an external source, isolating the negative charge pump.

Current draw from either V_+ or V_- is supplied by the reservoir capacitor alone during one half cycle of the clock. Calculate the resulting ripple voltage on either output as follows:

$$V_{RIPPLE} = \frac{1}{2} I_{LOAD} (1 / f_{PUMP}) (1 / C_{RESERVOIR})$$

where I_{LOAD} is the load on either V_+ or V_- . For example, with an f_{PUMP} of 33kHz and 6.8μF reservoir capacitors, the ripple is 26mV when I_{LOAD} is 12mA. Remember that, in most applications, the total load on V_+ is the V_+ load current (I_{V+}) and the current taken by the negative charge pump (I_{V-}).

Shutdown

The MAX864 features a shutdown mode that reduces the maximum supply current to 1μA over temperature. The \overline{SHDN} pin is an active-low TTL logic-level input. If the shutdown feature is unused, connect \overline{SHDN} to IN. In shutdown mode, V_+ connects to IN through a 22Ω switch and V_- connects to GND through a 6Ω switch.

Efficiency Considerations

Theoretically, a charge-pump voltage multiplier can approach 100% efficiency under the following conditions:

- The charge-pump switches have virtually no offset, and extremely low on-resistance.
- The drive circuitry consumes minimal power.
- The impedances of the reservoir and pump capacitors are negligible.

For the MAX864, the energy loss per clock cycle is the sum of the energy loss in the positive and negative converters, as follows:

$$\begin{aligned} LOSS_{CYCLE} &= LOSS_{POS} + LOSS_{NEG} \\ &= \frac{1}{2} C1 \left[(V_+)^2 - 2(V_+) (V_{IN}) \right] \\ &\quad + \frac{1}{2} C2 \left[(V_+)^2 - (V_-)^2 \right] \end{aligned}$$

where V_+ and V_- are the actual measured output voltages.

The average power loss is simply:

Resulting in an efficiency of:

$$P_{LOSS} = LOSS_{CYCLE} \times f_{PUMP}$$

$$\eta = \text{Total Output Power} / (\text{Total Output Power} - P_{LOSS})$$

There will be a substantial voltage difference between $(V_+ - V_{IN})$ and V_{IN} for the positive pump, and between V_+ and V_- if the impedances of the pump capacitors ($C1$ and $C2$) are large with respect to their respective output loads.

Larger reservoir capacitor ($C3$ and $C4$) values will reduce output ripple. Larger values of both pump and reservoir capacitors will improve efficiency.

Dual-Output Charge Pump with Shutdown

Applications Information

Positive and Negative Converter

The most common application of the MAX864 is as a dual charge-pump voltage converter that provides positive and negative outputs of two times a positive input voltage for biasing analog circuitry (Figure 3). Select a charge-pump frequency high enough so it does not interfere with other circuitry, but low enough to maintain low supply current. See Table 1 for the correct device configuration.

Paralleling Devices

Paralleling multiple MAX864s reduces the output resistance of both the positive and negative converters (Figure 4). The effective output resistance is the output resistance of one device divided by the total number of devices. Separate C1 and C2 charge-pump capacitors are required for each MAX864, but the reservoir capacitors C3 and C4 can be shared.

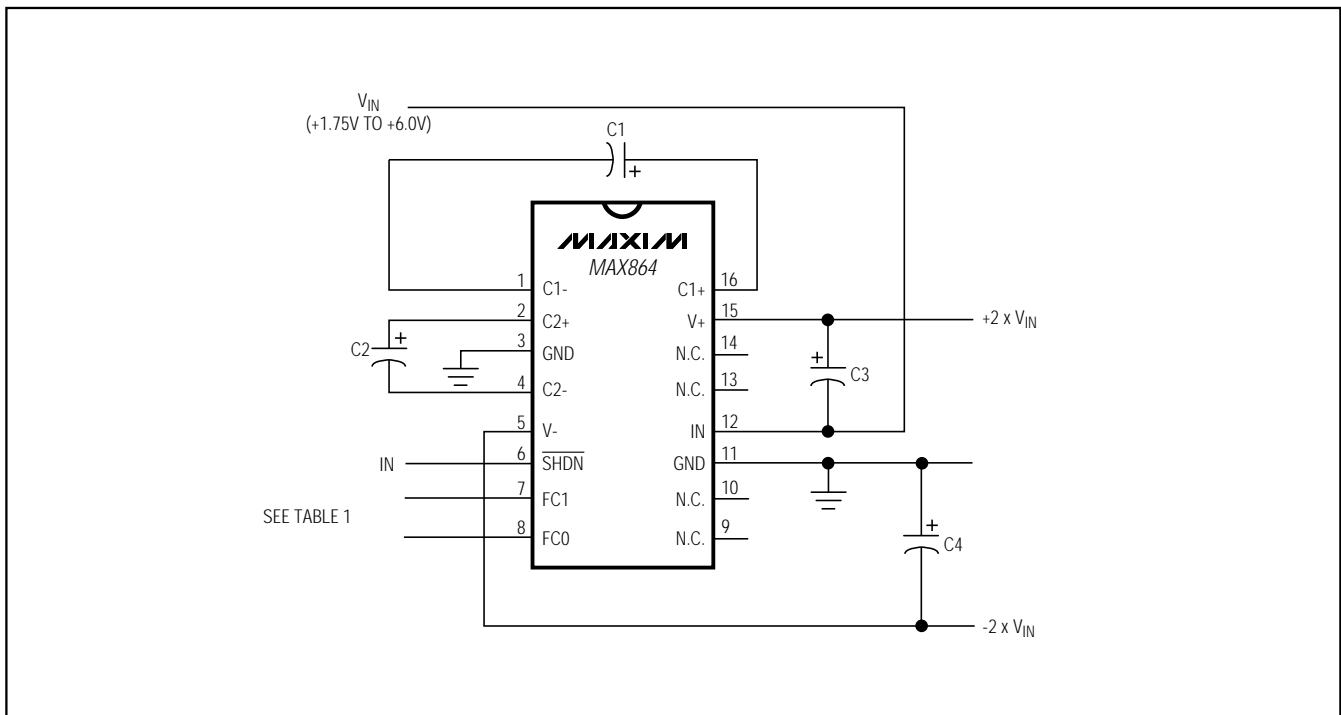

Figure 3. Positive and Negative Converter

Dual-Output Charge Pump with Shutdown

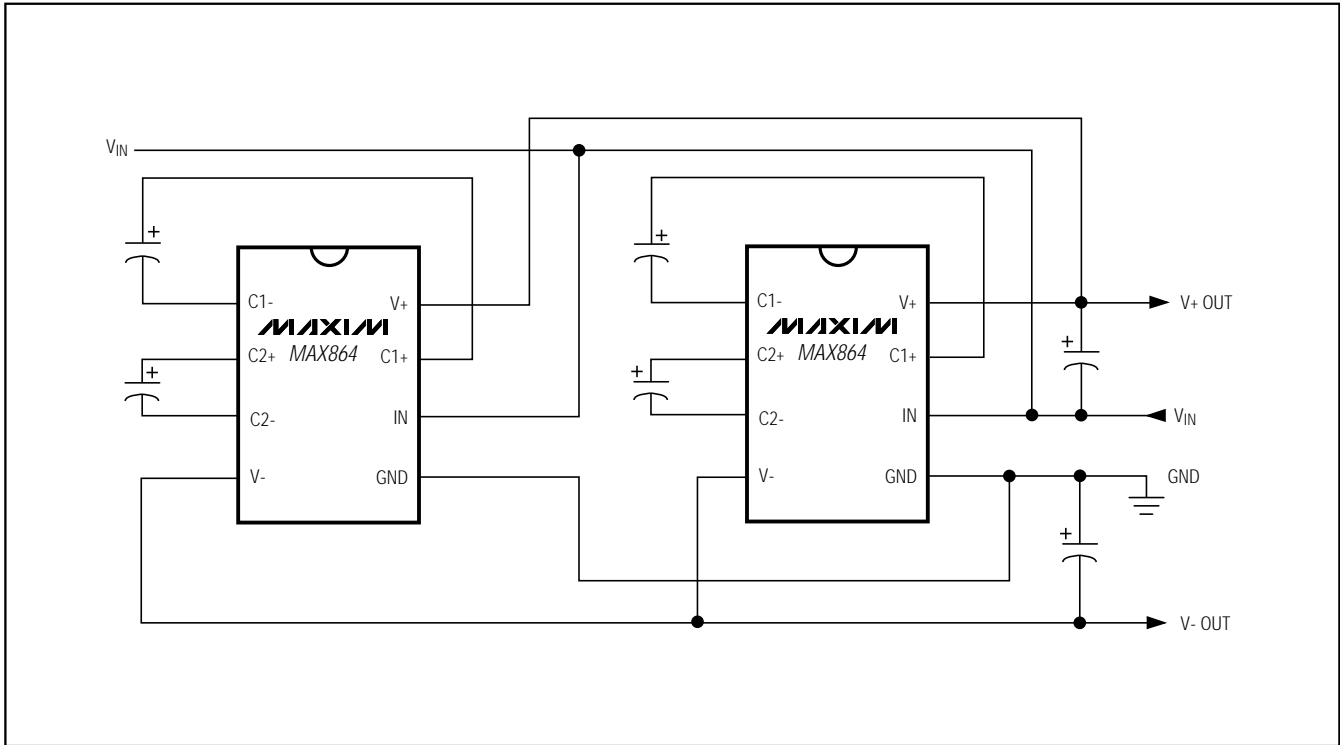

Figure 4. Paralleling Two MAX864s

Heavy Output Current Loads

When under heavy loads, where $V+$ is sourcing current into $V-$ (i.e., load current flows from $V+$ to $V-$, rather than from supply to ground), do not allow the $V-$ supply to pull above ground. In applications where large currents flow from $V+$ to $V-$, use a Schottky diode (1N5817) between GND and $V-$, with the anode connected to GND (Figure 5).

Layout and Grounding

Good layout is important, primarily for good noise performance. To ensure good layout, mount all components as close together as possible, keep traces short to minimize parasitic inductance and capacitance, and use a ground plane. Connecting all N.C. pins to a ground plane improves thermal dissipation.

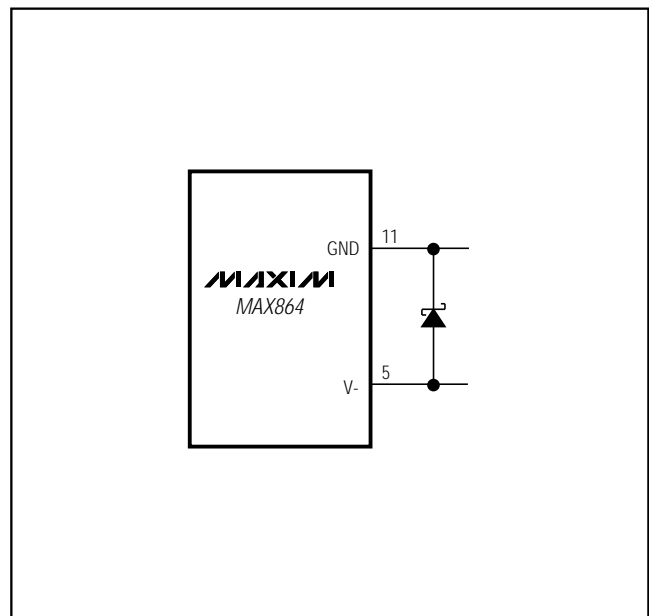
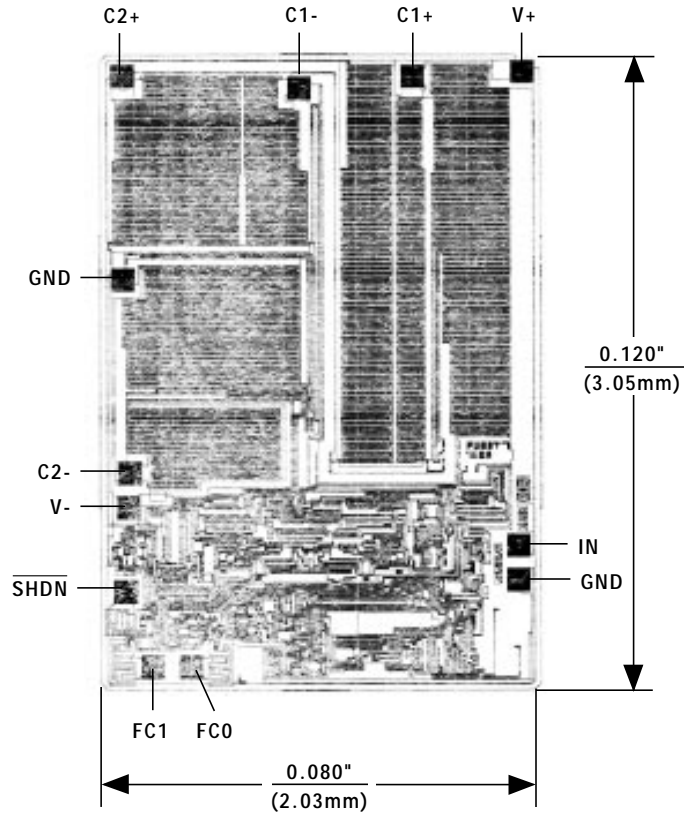

Figure 5. High $V-$ Load Circuit

Dual-Output Charge Pump with Shutdown

Chip Topography



TRANSISTOR COUNT: 143
SUBSTRATE CONNECTED TO V+

Dual-Output Charge Pump with Shutdown

Package Information

MAX864

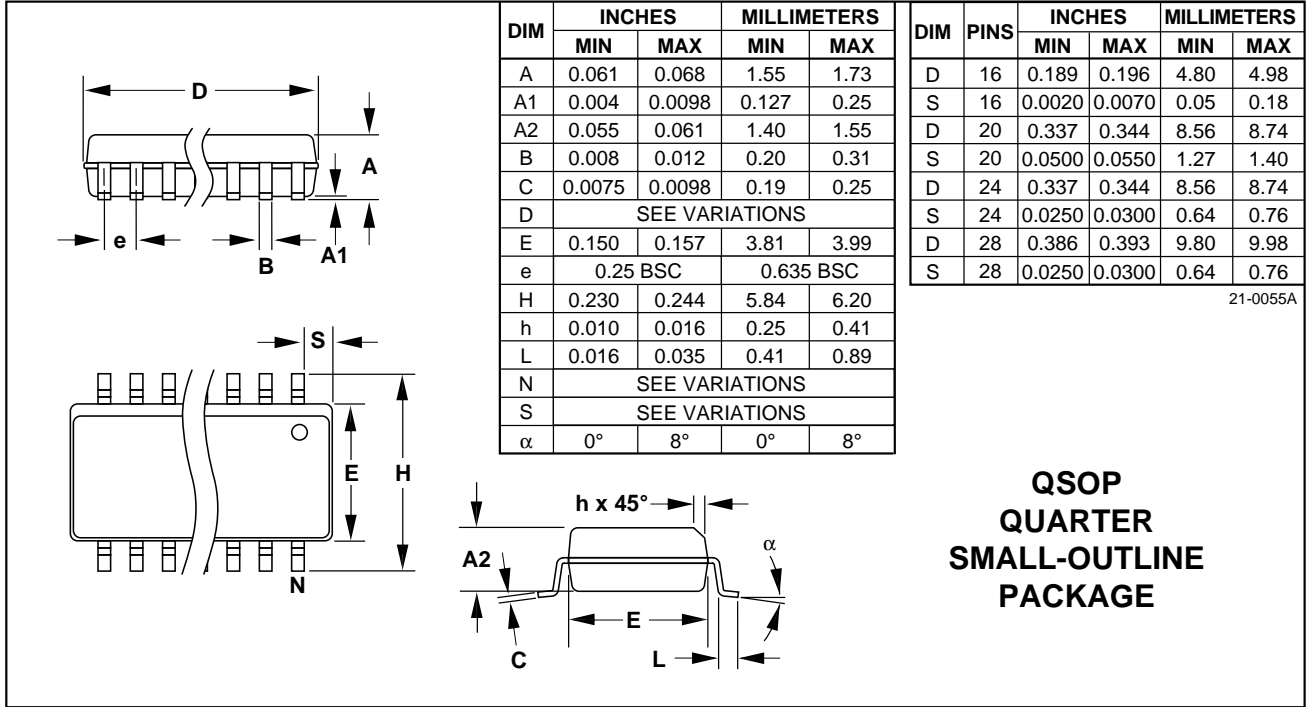

Dual-Output Charge Pump with Shutdown

Maxim cannot assume responsibility for use of any circuitry other than circuitry entirely embodied in a Maxim product. No circuit patent licenses are implied. Maxim reserves the right to change the circuitry and specifications without notice at any time.

12 _____ Maxim Integrated Products, 120 San Gabriel Drive, Sunnyvale, CA 94086 (408) 737-7600

Looking for pricing, stock, or lifecycle information?

Click below to explore more details on WIN SOURCE:

- ⊖ [View MAX864EEE+ on WIN SOURCE](#)
- ⊖ [Maxim Integrated Information](#)

Optimize Your Supply Chain with WIN SOURCE Solutions

- ✓ Global Sourcing Solution
- ✓ Obsolete Management
- ✓ Cost Control Management
- ✓ Shortage Management
- ✓ Alternative Solution
- ✓ Excess Inventory Management