



**THE DATASHEET OF
MAX8860EUA25+**



MAXIM

Low-Dropout, 300mA Linear Regulator in μ MAX

MAX8860

General Description

The MAX8860 low-noise, low-dropout linear regulator operates from a 2.5V to 6.5V input and is guaranteed to deliver 300mA. Typical output noise for this device is 60 μ V_{RMS}, and typical dropout is 105mV at 200mA. In addition to the six available preset output voltages (1.8V, 2.5V, 2.77V, 2.82V, 3V, and 3.3V), the Dual Mode™ feature allows the device to be configured as an adjustable output regulator from 1.25V to 6.5V.

Designed with an internal P-channel MOSFET pass transistor, the MAX8860 has a low 120 μ A supply current. An output fault-detection circuit indicates loss of regulation. Other features include a 10nA, logic-controlled shutdown mode, short-circuit and thermal-shutdown protection, and reverse battery protection. The MAX8860 is available in a miniature 8-pin μ MAX package.

Applications

Wireless Handsets
 DSP Core Power
 PCMCIA Cards
 Hand-Held Instruments
 Palmtop Computers
 Electronic Planners

Typical Operating Circuit

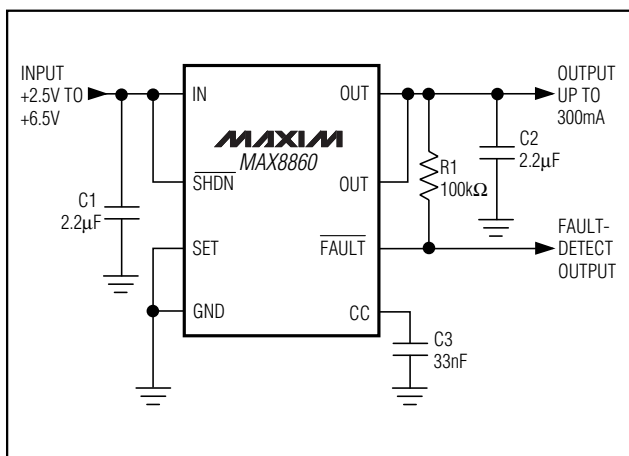

Dual Mode is a trademark of Maxim Integrated Products.

Features

- ◆ High Output Current (300mA)
- ◆ Low Output Voltage Noise: 60 μ V_{RMS}
- ◆ Low 105mV Dropout at 200mA Output
- ◆ Low 120 μ A No-Load Supply Current
- ◆ Thermal Overload and Short-Circuit Protection
- ◆ Reverse Battery Protection
- ◆ 10nA Logic-Controlled Shutdown
- ◆ FAULT Indicator
- ◆ Small, Space-Saving μ MAX Package (1.1mm max height)
- ◆ Small 2.2 μ F Output Capacitor Saves Space and Cost

Ordering Information

PART	TEMP RANGE	PIN-PACKAGE	V _{OUT} (V)
MAX8860EUA18	-40°C to +85°C	8 μ MAX	+1.80
MAX8860EUA25	-40°C to +85°C	8 μ MAX	+2.50
MAX8860EUA27	-40°C to +85°C	8 μ MAX	+2.77
MAX8860EUA28	-40°C to +85°C	8 μ MAX	+2.82
MAX8860EUA30	-40°C to +85°C	8 μ MAX	+3.00
MAX8860EUA33	-40°C to +85°C	8 μ MAX	+3.30

Pin Configuration

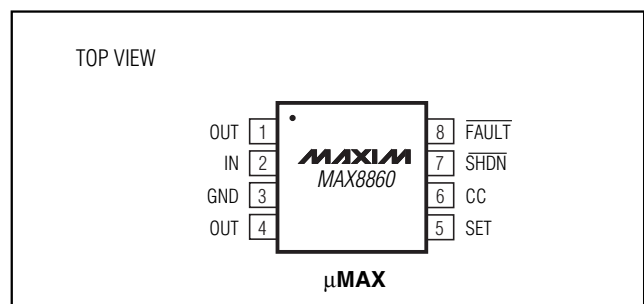

Low-Dropout, 300mA Linear Regulator in μ MAX

ABSOLUTE MAXIMUM RATINGS

IN, $\overline{\text{SHDN}}$ to GND	-7V to +7V
$\overline{\text{SHDN}}$ to IN	-7V to +0.3V
SET, CC, $\overline{\text{FAULT}}$ to GND	-0.3V to +7V
OUT to GND	-0.3V to ($V_{\text{IN}} + 0.3\text{V}$)
$\overline{\text{FAULT}}$ Sink Current	20mA
Continuous Output Current	330mA
Output Short-Circuit Duration	Continuous
Continuous Power Dissipation ($T_A = +70^\circ\text{C}$)	
8-Pin μ MAX (derate 4.1mW/ $^\circ\text{C}$ above $+70^\circ\text{C}$)	330mW

Thermal Resistance (θ_{JA})	
8-Pin μ MAX	+244 $^\circ\text{C}/\text{W}$
Operating Temperature Range	
MAX8860EUA_ _	-40 $^\circ\text{C}$ to +85 $^\circ\text{C}$
Junction Temperature	+150 $^\circ\text{C}$
Storage Temperature Range	-65 $^\circ\text{C}$ to +150 $^\circ\text{C}$
Lead Temperature (soldering, 10sec)	+300 $^\circ\text{C}$

Stresses beyond those listed under "Absolute Maximum Ratings" may cause permanent damage to the device. These are stress ratings only, and functional operation of the device at these or any other conditions beyond those indicated in the operational sections of the specifications is not implied. Exposure to absolute maximum rating conditions for extended periods may affect device reliability.

ELECTRICAL CHARACTERISTICS

($V_{\text{IN}} = 3.6\text{V}$, $C_{\text{CC}} = 33\text{nF}$, $T_A = -40^\circ\text{C}$ to $+85^\circ\text{C}$, unless otherwise noted. Typical values are at $T_A = +25^\circ\text{C}$.) (Note 1)

PARAMETER	CONDITIONS		MIN	TYP	MAX	UNITS	
Input Voltage (Note 2)			2.5		6.5	V	
Output Voltage	$100\mu\text{A} < I_{\text{OUT}} < 300\text{mA}$, $V_{\text{IN}} = V_{\text{OUT}} + 1\text{V}$, SET = GND	MAX8860EUA33	$T_A = +25^\circ\text{C}$	3.24	3.3	3.35	V
			$T_A = -40^\circ\text{C}$ to $+85^\circ\text{C}$	3.21		3.38	
		MAX8860EUA30	$T_A = +25^\circ\text{C}$	2.95	3.00	3.05	
			$T_A = -40^\circ\text{C}$ to $+85^\circ\text{C}$	2.92		3.08	
		MAX8860EUA28	$T_A = +25^\circ\text{C}$	2.78	2.82	2.87	
			$T_A = -40^\circ\text{C}$ to $+85^\circ\text{C}$	2.75		2.90	
		MAX8860EUA27	$T_A = +25^\circ\text{C}$	2.73	2.77	2.81	
			$T_A = -40^\circ\text{C}$ to $+85^\circ\text{C}$	2.70		2.84	
		MAX8860EUA25	$T_A = +25^\circ\text{C}$	2.46	2.50	2.54	
			$T_A = -40^\circ\text{C}$ to $+85^\circ\text{C}$	2.43		2.57	
		MAX8860EUA18	$T_A = +25^\circ\text{C}$	1.77	1.80	1.83	
			$T_A = -40^\circ\text{C}$ to $+85^\circ\text{C}$	1.755		1.845	
SET Threshold Voltage	SET = OUT, $V_{\text{IN}} = 2.5\text{V}$ to 6.5V , $I_{\text{OUT}} = 1\text{mA}$	$T_A = +25^\circ\text{C}$	1.230	1.248	1.267	V	
		$T_A = -40^\circ\text{C}$ to $+85^\circ\text{C}$	1.220		1.275		
Adjustable Output Voltage Range (Note 3)			1.25		6.5	V	
Maximum Output Current	DC average current rating		300			mA	
Output Current Limit			330	770		mA	
Supply Current	SET = GND	$I_{\text{OUT}} = 0$		120	270	μA	
		$I_{\text{OUT}} = 300\text{mA}$		165			
Shutdown Supply Current	$V_{\text{OUT}} = 0$, $\overline{\text{SHDN}} = \text{GND}$	$T_A = +25^\circ\text{C}$		0.01	1	μA	
		$T_A = +85^\circ\text{C}$		0.05			
Dropout Voltage (Note 4)	$I_{\text{OUT}} = 1\text{mA}$			0.6		mV	
	$I_{\text{OUT}} = 200\text{mA}$			105	220		
	$I_{\text{OUT}} = 300\text{mA}$			155			
Line Regulation	$V_{\text{IN}} = 2.5\text{V}$ to 6.5V , SET = OUT, $I_{\text{OUT}} = 1\text{mA}$		-0.1	0.01	0.1	%/V	
Load Regulation	$I_{\text{OUT}} = 100\mu\text{A}$ to 300mA	SET = OUT		0.0001		%/mA	
		SET = GND		0.0006			

Low-Dropout, 300mA Linear Regulator in μ MAX

MAX8860

ELECTRICAL CHARACTERISTICS (continued)

($V_{IN} = 3.6V$, $C_{CC} = 33nF$, $T_A = -40^{\circ}C$ to $+85^{\circ}C$, unless otherwise noted. Typical values are at $T_A = +25^{\circ}C$.) (Note 1)

PARAMETER	CONDITIONS	MIN	TYP	MAX	UNITS
Output Voltage Noise	$I_{OUT} = 10mA$, $10Hz < f < 100kHz$	$C_{OUT} = 2.2\mu F$		65	μV_{RMS}
		$C_{OUT} = 10\mu F$		60	
		$C_{OUT} = 100\mu F$		55	
Output Voltage Noise Density	$10Hz < f < 100kHz$, $C_{OUT} = 10\mu F$		190		$nV\sqrt{Hz}$
\overline{SHDN} Input Threshold	V_{IH} , $2.5V \leq V_{IN} \leq 5.5V$	2.0			V
	V_{IL} , $2.5V \leq V_{IN} \leq 5.5V$			0.4	V
\overline{SHDN} Input Bias Current	$\overline{SHDN} = GND$ or IN	$T_A = +25^{\circ}C$	0.01	100	nA
		$T_A = +85^{\circ}C$		0.5	
SET Input Leakage Current (Note 3)	$V_{SET} = 1.3V$	$T_A = +25^{\circ}C$	0.01	2.5	nA
		$T_A = +85^{\circ}C$		0.5	
\overline{FAULT} Detection Voltage (Note 5)	$SET = GND$, $I_{OUT} = 200mA$		130	280	mV
\overline{FAULT} Output Low Voltage	$V_{IN} = 2.5V$, $I_{SINK} = 2mA$			0.25	V
\overline{FAULT} Output Off-Leakage Current	$V_{\overline{FAULT}} = 3.6V$	$T_A = +25^{\circ}C$	0.01	100	nA
		$T_A = +85^{\circ}C$		0.5	
Thermal Shutdown Temperature			170		$^{\circ}C$
Thermal Shutdown Hysteresis			20		$^{\circ}C$
Start-Up Time	$C_{OUT} = 10\mu F$, V_{OUT} to 90% of final value		120		μs

Note 1: Specifications to $-40^{\circ}C$ are guaranteed by design and not production tested.

Note 2: Guaranteed by line-regulation test.

Note 3: Adjustable mode only.

Note 4: The dropout voltage is defined as $V_{IN} - V_{OUT}$ when V_{OUT} is 100mV below the value of V_{OUT} for $V_{IN} = V_{OUT} + 2V$. Since the minimum input voltage is 2.5V, this is applicable only for voltages of 2.5V or higher.

Note 5: The \overline{FAULT} detection voltage is the difference from input to output voltage. Maintain the input above this level to ensure good line and load regulation.

Typical Operating Characteristics

($V_{IN} = V_{OUT} + 0.5V$, $C_{IN} = C_{OUT} = 2.2\mu F$, $C_{CC} = 33nF$, $T_A = +25^{\circ}C$, unless otherwise noted.)

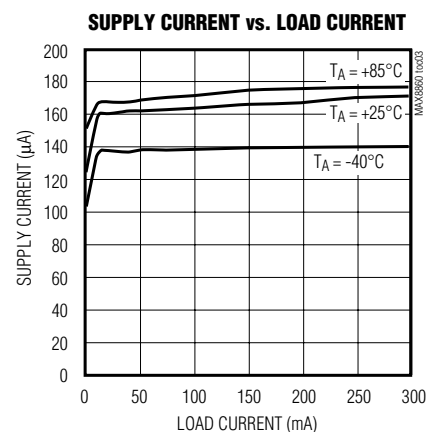
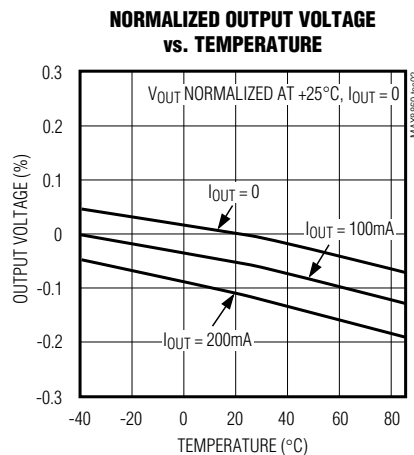
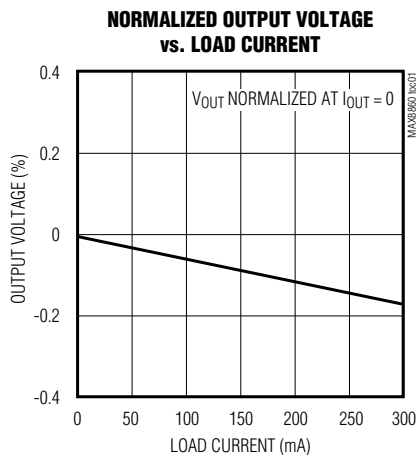

Low-Dropout, 300mA Linear Regulator in μ MAX

Typical Operating Characteristics (continued)

($V_{IN} = V_{OUT} + 0.5V$, $C_{IN} = C_{OUT} = 2.2\mu F$, $C_{CC} = 33nF$, $T_A = +25^\circ C$, unless otherwise noted.)

NO LOAD SUPPLY CURRENT vs. INPUT VOLTAGE

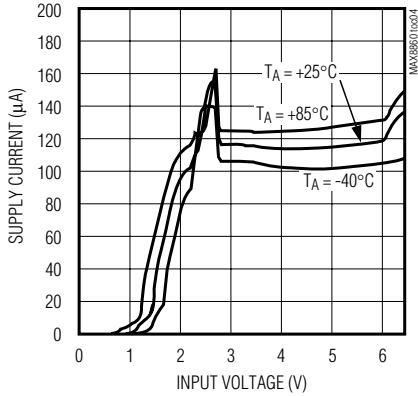

DROPOUT VOLTAGE vs. LOAD CURRENT

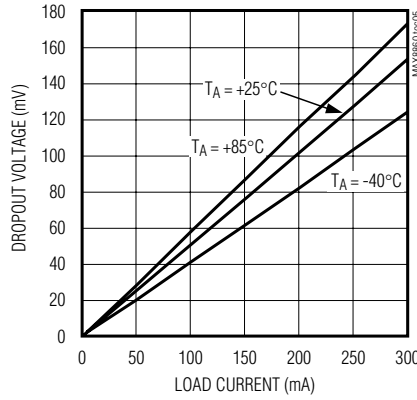

FAULT DETECT THRESHOLD vs. LOAD CURRENT

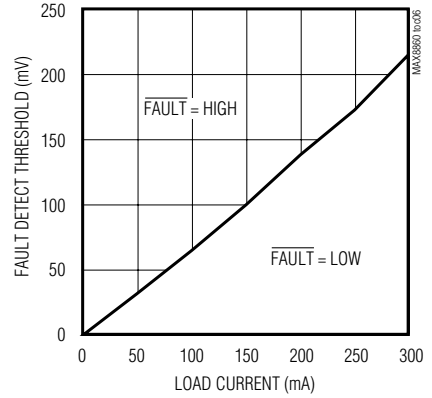

POWER-SUPPLY REJECTION RATIO vs. FREQUENCY

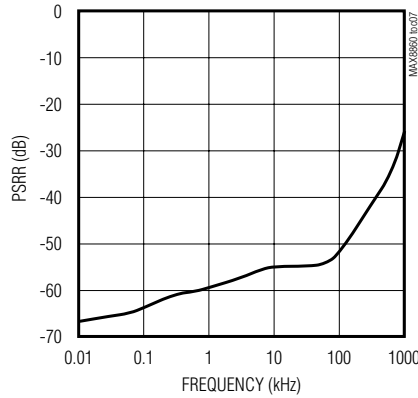

OUTPUT NOISE SPECTRAL DENSITY

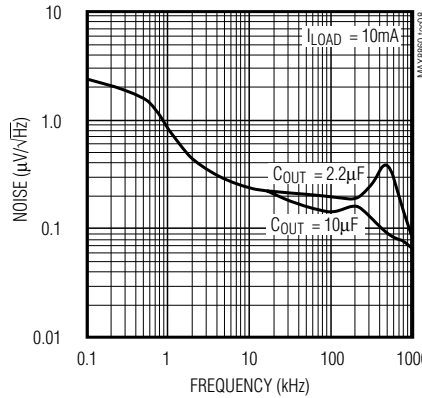

OUTPUT NOISE (10Hz TO 1MHz)

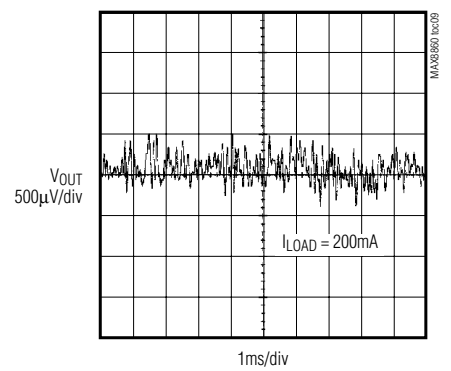

LOAD-TRANSIENT RESPONSE

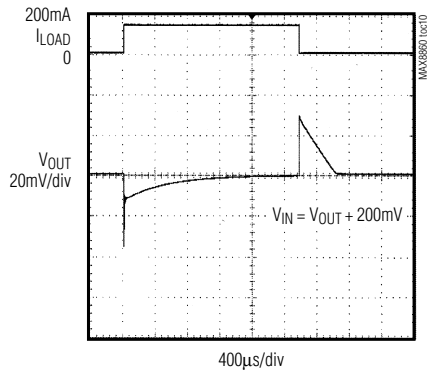

LINE-TRANSIENT RESPONSE

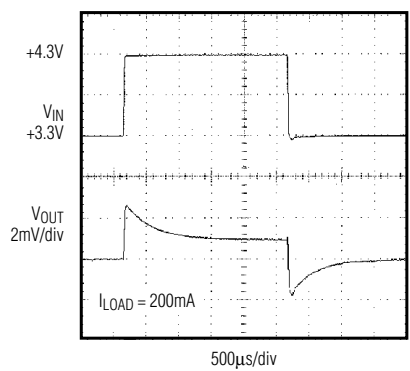

Low-Dropout, 300mA Linear Regulator in μ MAX

MAX8860

Typical Operating Characteristics (continued)

($V_{IN} = V_{OUT} + 0.5V$, $C_{IN} = C_{OUT} = 2.2\mu F$, $C_{CC} = 33nF$, $T_A = +25^\circ C$, unless otherwise noted.)

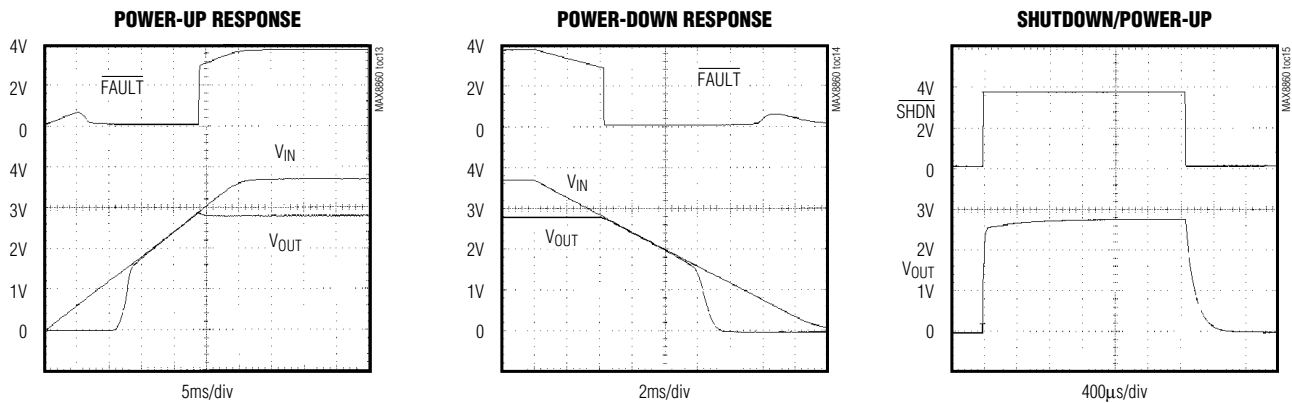

Pin Description

PIN	NAME	FUNCTION
1, 4	OUT	Regulator Output. Bypass with 2.2 μF , low-ESR capacitor to GND for stable operation.
2	IN	Supply Input. Connect to power source (2.5V to 6.5V). Bypass with 2.2 μF capacitor to GND.
3	GND	Ground
5	SET	Output Voltage Set. Connect to GND for internally set threshold. Connect to resistor-divider for adjustable output voltages. See <i>the Output Voltage Selection</i> section for more information.
6	CC	Compensation Capacitor. Connect a 0.033 μF capacitor from CC to GND.
7	\overline{SHDN}	Shutdown Input. Connect to IN for normal operation. Drive \overline{SHDN} low to turn off the regulator.
8	\overline{FAULT}	Fault Output. A high-impedance, open-drain output. When the MAX8860 is out of regulation, \overline{FAULT} goes low. In shutdown, the \overline{FAULT} pin is high impedance. Connect to GND if unused.

Detailed Description

The MAX8860 is a low-dropout, low-quiescent-current linear regulator designed primarily for battery-powered applications. It supplies an adjustable 1.25V to 6.5V output voltage or a fixed-voltage output of 1.8V (MAX8860EUA18), 2.5V (MAX8860EUA25), 2.77V (MAX8860EUA27), 2.82V (MAX8860EUA28), 3.0V (MAX8860EUA30), or 3.3V (MAX8860EUA33) for load currents up to 300mA. The devices with 2.77V and 2.82V nominal outputs are designed to guarantee minimum output voltages of 2.70V and 2.75V, respectively. The device consists of a 1.25V reference, error amplifier, MOSFET driver, P-channel pass transistor, Dual Mode comparator, fault detector, and internal-feedback voltage divider (Figure 1).

The 1.25V bandgap reference is connected to the error amplifier's inverting input. The error amplifier compares

this reference to the selected feedback voltage and amplifies the difference. The MOSFET driver reads the error signal and applies the appropriate drive to the P-channel pass transistor. If the feedback voltage is lower than the reference voltage, the pass-transistor gate is pulled lower, allowing more current to pass and increasing the output voltage. If the feedback voltage is higher than the reference voltage, the pass-transistor gate is driven higher, allowing less current to pass to the output. The output voltage is fed back through either an internal resistor voltage divider connected to OUT, or an external resistor network connected to SET. The Dual Mode comparator examines V_{SET} and selects the feedback path. If V_{SET} is below 60mV, internal feedback is used and the output voltage is regulated to the preset output voltage. Additional blocks include an output current limiter, reverse battery protection, a thermal sensor, a fault detector, and shutdown logic.

Low-Dropout, 300mA Linear Regulator in μ MAX

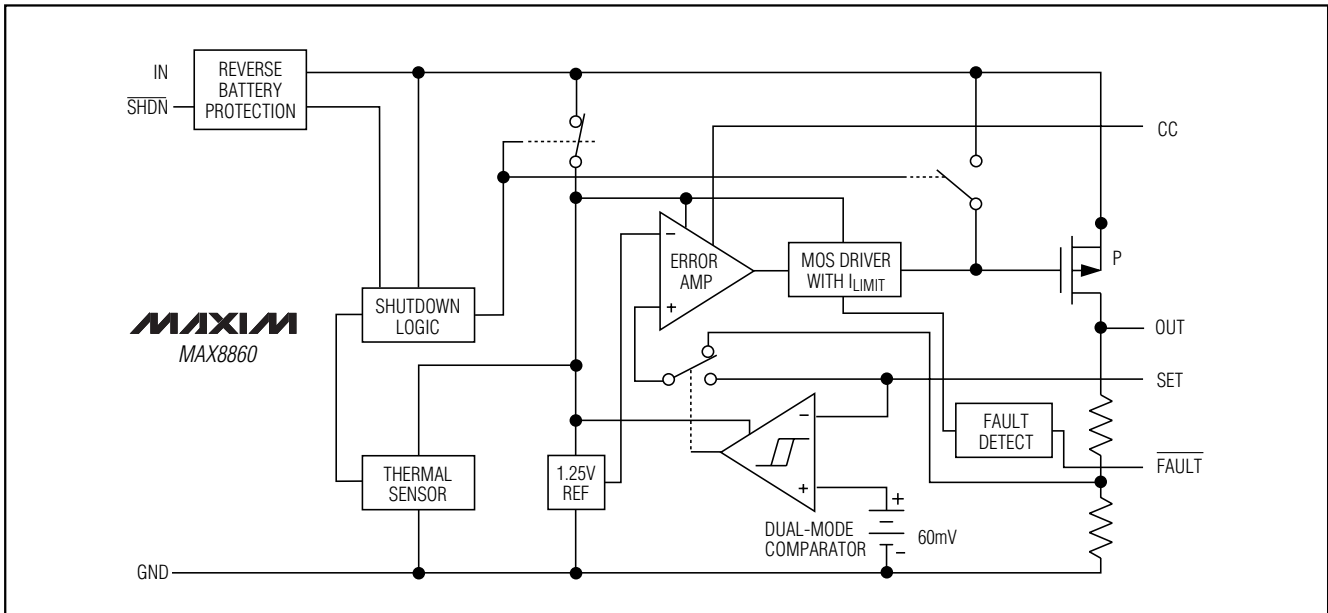

Figure 1. Functional Diagram

Internal P-Channel Pass Transistor

The MAX8860 features a 0.5Ω typical P-channel MOSFET pass transistor. This provides several advantages over similar designs using PNP pass transistors, including longer battery life. PNP-based regulators waste considerable amounts of current in dropout when the pass transistor saturates. They also use high base-drive currents under large loads. The P-channel MOSFET requires no base-drive current, which reduces quiescent current considerably. The MAX8860 consumes less than $165\mu\text{A}$ of quiescent current whether in dropout, light-load, or heavy-load applications (see the *Typical Operating Characteristics*).

Output Voltage Selection

The MAX8860 features Dual Mode operation: it operates in either a preset voltage mode or an adjustable mode. In preset voltage mode, internal, trimmed feedback resistors set the output voltage to an adjustable 1.25V to 6.5V output voltage or a fixed-voltage output of 1.8V (MAX8860EUA18), 2.5V (MAX8860EUA25), 2.77V (MAX8860EUA27), 2.82V (MAX8860EUA28), 3V (MAX8860EUA30), or 3.3V (MAX8860EUA33). Select this mode by connecting SET to ground. In adjustable mode, select an output between 1.25V and 6.5V using two external resistors connected as a voltage divider to SET (Figure 2). Calculate the output voltage with the following equation:

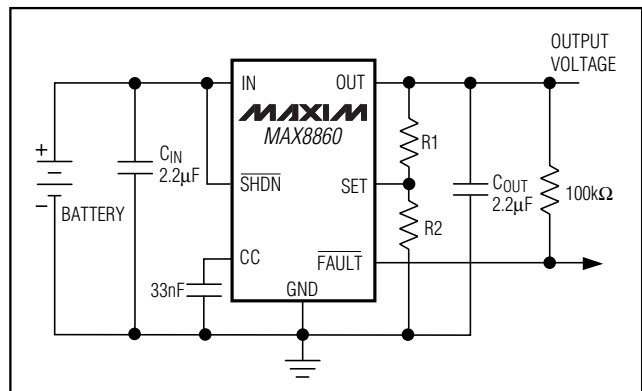

Figure 2. Adjustable Output Using External Feedback Resistors

$$V_{\text{OUT}} = V_{\text{SET}} \left(1 + \frac{R1}{R2} \right)$$

where $V_{\text{SET}} = 1.25\text{V}$. To simplify resistor selection, use the following equation:

$$R1 = R2 \left(\frac{V_{\text{OUT}}}{V_{\text{SET}}} - 1 \right)$$

Low-Dropout, 300mA Linear Regulator in μ MAX

MAX8860

Choose $R_2 = 100k\Omega$ to optimize power consumption, accuracy, and high-frequency power-supply rejection. Ensure that the total current through the external resistive feedback and load resistors is not less than $10\mu A$. Since the V_{SET} tolerance is typically less than $\pm 20mV$, set the output using fixed resistors instead of trim pots.

In preset voltage mode, connect SET to GND. Keep impedances between SET and ground to less than $100k\Omega$. Otherwise, spurious conditions can cause V_{SET} to exceed the 60mV Dual Mode threshold.

Shutdown

Drive \overline{SHDN} low to place the MAX8860 in shutdown mode. In shutdown mode, the pass transistor, control circuit, reference, and all biases are turned off, reducing the supply current to typically 10nA. Connect \overline{SHDN} to IN for normal operation.

Current Limit

The MAX8860 includes short-circuit protection. It includes a current limiter that controls the pass transistor's gate voltage to limit the output current to about 770mA. For design purposes, the minimum current limit is 330mA.

Thermal Overload Protection

Thermal overload protection limits total power dissipation in the MAX8860. When the junction temperature (T_J) exceeds $+170^\circ C$, the thermal sensor sends a signal to the shutdown logic, turning off the pass transistor and allowing the IC to cool. The pass transistor turns on again after the IC's junction temperature typically cools by $20^\circ C$, resulting in a pulsed output during continuous thermal overload conditions.

Thermal overload protection is designed to protect the MAX8860 against fault conditions. Stressing the device with high-load currents and high input-output differential voltages (which result in die temperatures above $+125^\circ C$) may cause a momentary overshoot (2% to 8% for 200ms) when the load is completely removed. Remedy this by raising the minimum load current from 0 ($+125^\circ C$) to $100\mu A$ ($+150^\circ C$). This is accomplished with an external load resistor. For continuous operation, do not exceed the absolute maximum junction temperature rating of $+150^\circ C$.

Operating Region and Power Dissipation

Maximum power dissipation of the MAX8860 depends on the thermal resistance of the case and circuit board, the temperature difference between the die junction and ambient air, and the rate of air flow. The power dissipated by the device is:

$$P = I_{OUT} (V_{IN} - V_{OUT})$$

The maximum power dissipation is:

$$P_{MAX} = (T_{JMAX} - T_A) / \theta_{JA}$$

where: $T_{JMAX} = +150^\circ C$

T_A is the ambient temperature

$$\theta_{JA} = 244^\circ C/W$$

The MAX8860's pins perform the dual function of providing an electrical connection as well as channeling heat away from the die. Use wide circuit-board traces and large, solid copper polygons to improve power dissipation. Using multiple vias to buried ground planes further enhances thermal conductivity.

Reverse Battery Protection

The MAX8860 has a unique protection scheme that limits the reverse supply current to less than 1mA when either V_{IN} or $V_{\overline{SHDN}}$ falls below GND. The circuitry monitors the polarity of these two pins, disconnecting the internal circuitry and parasitic diodes when the applied voltage is reversed. This feature prevents the device from overheating and damaging an improperly installed battery.

Integrator Circuitry

The MAX8860 uses an external 33nF compensation capacitor for minimizing load- and line-regulation errors and for lowering output noise. When the output voltage shifts due to varying load current or input voltage, the integrator capacitor voltage is raised or lowered to compensate for the systematic offset at the error amplifier. Compensation is limited to $\pm 5\%$ to minimize transient overshoot when the device goes out of dropout, current limit, or thermal shutdown.

Fault-Detection Circuitry

When the output voltage goes out of regulation—such as during dropout, current limit, or thermal shutdown— \overline{FAULT} goes low. In addition, the fault-detection circuitry detects when the input-to-output voltage differential is insufficient to ensure good load and line regulation at the output. When the input-to-output voltage differential is less than 130mV for a load current of 200mA, \overline{FAULT} also goes low. The differential threshold is designed to be always higher than and track with the dropout voltage, and to scale proportionally with load current (see Fault Detect Threshold vs. Load Current graph in the *Typical Operating Characteristics*).

The \overline{FAULT} pin is an open-drain N-channel MOSFET. To create a voltage level output, connect a pull-up resistor from \overline{FAULT} to OUT. To minimize current consumption, make this resistor as large as practical. A $100k\Omega$ resistor works well for most applications.

Low-Dropout, 300mA Linear Regulator in μ MAX

$V_{IN} > +5.5V$ Minimum Load Current Requirements

When operating the MAX8860 with an input voltage above 5.5V, a minimum load current of 50 μ A is required to maintain regulation in preset voltage mode. When setting the output with external resistors, ensure that the minimum current through the external feedback resistors and load is at least 60 μ A. This applies only when the input voltage exceeds 5.5V. For input voltages less than 5.5V, the MAX8860 maintains regulation and stability without external loading.

Applications Information

Capacitor Selection and Regulator Stability

Typically, use a 2.2 μ F capacitor on the input and a 2.2 μ F capacitor on the output of the MAX8860. Capacitor type is not critical, as long as it has an ESR less than 0.5 Ω . Larger capacitor values and lower ESR provide better supply-noise rejection and transient response. Use higher-value capacitors (10 μ F) if large, fast input or load transients are anticipated or if the device is located several inches from the power source. For stable operation over the full temperature range, with load currents up to 300mA, a minimum output-capacitor value of 2.2 μ F is recommended. There is no upper limit to capacitor size. The circuit used to generate the typical operating characteristics data used 2.2 μ F, X7R, 16V (1206) ceramic capacitors. These capacitors typically have an ESR of 50m Ω .

Power-Supply Rejection and Operation from Sources Other than Batteries

The MAX8860 is designed to deliver low dropout voltage and low quiescent current in battery-powered systems. Power-supply rejection is 67dB at low frequencies and rolls off above 100kHz. At high frequencies, the output capacitor is the major contributor to the rejection of power-supply noise (see the Power-Supply Rejection Ratio vs. Frequency graph in the *Typical Operating Characteristics*).

When operating from sources other than batteries, improve supply-noise rejection and transient response by increasing the values of the input and output capacitors, and by using passive filtering techniques (see the supply and load-transient responses in the *Typical Operating Characteristics*).

Load-Transient Considerations

The MAX8860 load-transient response graph (see the *Typical Operating Characteristics*) shows the output response due to changing load current. Reduce overshoot by increasing the output capacitor's value and decreasing its ESR.

Input-Output (Dropout) Voltage

A regulator's minimum input-output voltage differential (or dropout voltage) determines the lowest usable supply voltage. In battery-powered systems, this determines the useful end-of-life battery voltage. Because the MAX8860 uses a P-channel MOSFET pass transistor, its dropout voltage is a function of $R_{DS(ON)}$ (typically 0.5 Ω) multiplied by the load current (see the *Electrical Characteristics* table).

Chip Information

TRANSISTOR COUNT: 148

Maxim cannot assume responsibility for use of any circuitry other than circuitry entirely embodied in a Maxim product. No circuit patent licenses are implied. Maxim reserves the right to change the circuitry and specifications without notice at any time.

8 _____ **Maxim Integrated Products, 120 San Gabriel Drive, Sunnyvale, CA 94086 408-737-7600**

Looking for pricing, stock, or lifecycle information?

Click below to explore more details on WIN SOURCE:

- ⊖ [View MAX8860EUA25+](#) on WIN SOURCE
- ⊖ [Maxim Integrated](#) Information

Optimize Your Supply Chain with WIN SOURCE Solutions

- ✓ Global Sourcing Solution
- ✓ Obsolete Management
- ✓ Cost Control Management
- ✓ Shortage Management
- ✓ Alternative Solution
- ✓ Excess Inventory Management