



**THE DATASHEET OF  
MAX8887EZK33+T**



# Low-Dropout, 300mA Linear Regulators in SOT23

## General Description

The MAX8887/MAX8888 low-dropout linear regulators operate from a 2.5V to 5.5V input and deliver up to 300mA continuous (500mA pulsed) current. The MAX8887 is optimized for low-noise operation, while the MAX8888 includes an open-drain power-OK (POK) output flag. Both regulators feature exceptionally low 100mV dropout at 200mA. These devices are available in a variety of preset output voltages in the 1.5V to 3.3V range.

An internal PMOS pass transistor allows the low 55 $\mu$ A supply current to remain independent of load, making these devices ideal for portable battery-powered equipment such as personal digital assistants (PDAs), cellular phones, cordless phones, and notebook computers. Other features include a micropower shutdown mode, short-circuit protection, thermal shutdown protection, and an active-low open-drain POK output that indicates when the output is out of regulation. The MAX8887/MAX8888 are available in a thin 5-pin SOT23 package that is only 1mm high.

## Applications

Notebook Computers  
 Wireless Handsets  
 PDAs and Palmtop Computers  
 Digital Cameras  
 PCMCIA Cards  
 Hand-Held Instruments

## Typical Operating Circuit

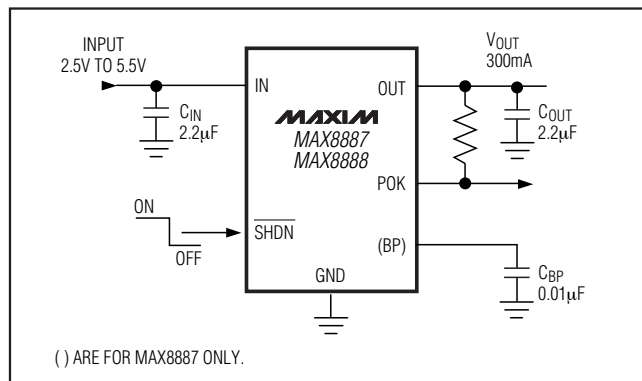

## Features

- ◆ Guaranteed 300mA Output Current (500mA for Pulsed Loads)
- ◆ Low 100mV Dropout at 200mA Load
- ◆ POK Output (MAX8888)
- ◆ 42 $\mu$ V<sub>RMS</sub> Output Noise (MAX8887)
- ◆ Preset Output Voltages (1.5V, 1.8V, 2.85V, and 3.3V)
- ◆ 55 $\mu$ A No-Load Supply Current
- ◆ Thermal-Overload and Short-Circuit Protection
- ◆ Foldback Output Current-Limit Protection
- ◆ 60dB PSRR at 1kHz
- ◆ 0.1 $\mu$ A Shutdown Current
- ◆ Thin 5-Pin SOT23 Package, 1mm High

## Ordering Information

PART	TEMP RANGE	PIN-PACKAGE	TOP MARK
MAX8887EZK15+T	-40°C to +85°C	5 SOT23	ADQD
MAX8887EZK18+T	-40°C to +85°C	5 SOT23	ADPX
MAX8887EZK29+T	-40°C to +85°C	5 SOT23	ADPY
MAX8887EZK33+T	-40°C to +85°C	5 SOT23	ADPZ
MAX8887EZKxy+T*	-40°C to +85°C	5 SOT23	—
MAX8888EZK15+T	-40°C to +85°C	5 SOT23	ADQE
MAX8888EZK18+T	-40°C to +85°C	5 SOT23	ADQA
MAX8888EZK18/V+T	-40°C to +85°C	5 SOT23	—
MAX8888EZK29+T	-40°C to +85°C	5 SOT23	ADQB
MAX8888EZK33+T	-40°C to +85°C	5 SOT23	ADQC
MAX8888EZKxy+T*	-40°C to +85°C	5 SOT23	—

\*Other versions (xy) between +1.5 and +3.3V are available in 100mV increments. Contact factory for other versions. Minimum order quantity is 25,000 units.

+Denotes a lead(Pb)-free RoHS-compliant package.

/V denotes an automotive qualified part.

## Pin Configurations

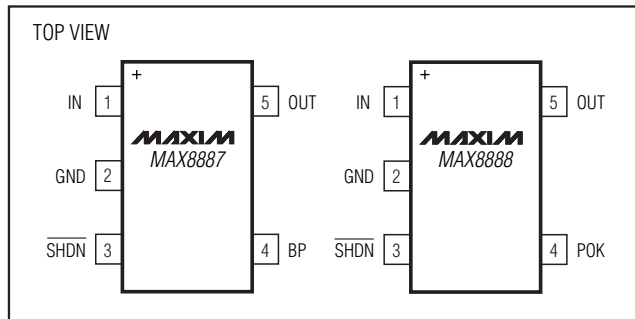

# Low-Dropout, 300mA Linear Regulators in SOT23

## ABSOLUTE MAXIMUM RATINGS

IN,  $\overline{\text{SHDN}}$ , POK, to GND.....-0.3V to +7V  
 OUT, BP to GND.....-0.3 to ( $V_{\text{IN}} + 0.3\text{V}$ )  
 Output Short-Circuit Duration.....Continuous  
 Continuous Power Dissipation ( $T_A = +70^\circ\text{C}$ )  
 5-Pin SOT23 (derate 9.1mW/ $^\circ\text{C}$  above  $+70^\circ\text{C}$ ).....727mW

Operating Temperature Range..... $-40^\circ\text{C}$  to  $+85^\circ\text{C}$   
 Junction Temperature..... $+150^\circ\text{C}$   
 Storage Temperature Range..... $-65^\circ\text{C}$  to  $+150^\circ\text{C}$   
 Lead Temperature (soldering, 10s)..... $+500^\circ\text{C}$

Stresses beyond those listed under "Absolute Maximum Ratings" may cause permanent damage to the device. These are stress ratings only, and functional operation of the device at these or any other conditions beyond those indicated in the operational sections of the specifications is not implied. Exposure to absolute maximum rating conditions for extended periods may affect device reliability.

## ELECTRICAL CHARACTERISTICS

( $V_{\text{IN}} = V_{\text{OUT}} + 1\text{V}$ ,  $\overline{\text{SHDN}} = \text{IN}$ ,  $T_A = -40^\circ\text{C}$  to  $+85^\circ\text{C}$ , unless otherwise noted.) (Note 1)

PARAMETER	SYMBOL	CONDITIONS	MIN	TYP	MAX	UNITS	
Input Voltage	$V_{\text{IN}}$		2.5		5.5	V	
Input Undervoltage Lockout		$V_{\text{IN}}$ rising (2% typical hysteresis)	2.15		2.4	V	
Output Voltage Accuracy		$T_A = +25^\circ\text{C}$ , $I_{\text{OUT}} = 100\text{mA}$	-1.2		+1.2	%	
		$I_{\text{OUT}} = 100\mu\text{A}$ to $300\text{mA}$ , $T_A = 0^\circ\text{C}$ to $+85^\circ\text{C}$	-2		+2		
		$I_{\text{OUT}} = 100\mu\text{A}$ to $300\text{mA}$	-3		+3		
Maximum Output Current		Continuous	300			mA	
		10ms pulse		500			
Current Limit		$V_{\text{OUT}} = 0$	300			mA	
		$V_{\text{OUT}} > 93\%$ of nominal value	420				
Ground-Pin Current		No load		55	100	$\mu\text{A}$	
		$I_{\text{OUT}} = 300\text{mA}$		65			
Dropout Voltage (Note 2)		$V_{\text{OUT}} = +3.3\text{V}$	$I_{\text{OUT}} = 1\text{mA}$		0.5	mV	
			$I_{\text{OUT}} = 200\text{mA}$		100		200
			$I_{\text{OUT}} = 300\text{mA}$		150		
Line Regulation		$V_{\text{IN}} = 2.5\text{V}$ or ( $V_{\text{OUT}} + 0.4\text{V}$ ) to $5.5\text{V}$ , $I_{\text{OUT}} = 5\text{mA}$	-0.15	0	0.15	%/V	
Output Noise		MAX8887	10Hz to 100kHz, $C_{\text{BP}} = 0.01\mu\text{F}$ , $C_{\text{OUT}} = 2.2\mu\text{F}$ , $\text{ESR}_{\text{COUT}} < 0.1\Omega$		42	$\mu\text{VRMS}$	
		MAX8888	10Hz to 100kHz, $C_{\text{OUT}} = 2.2\mu\text{F}$ , $\text{ESR}_{\text{COUT}} < 0.1\Omega$		360		
PSRR		MAX8887	$f < 1\text{kHz}$ , $C_{\text{BP}} = 0.01\mu\text{F}$ , $C_{\text{OUT}} = 4.7\mu\text{F}$ , $\text{ESR}_{\text{COUT}} < 0.1\Omega$		60	dB	
		MAX8888	$f < 1\text{kHz}$ , $C_{\text{OUT}} = 2.2\mu\text{F}$ , $\text{ESR}_{\text{COUT}} < 0.1\Omega$		40		

# Low-Dropout, 300mA Linear Regulators in SOT23

MAX8887/MAX8888

## ELECTRICAL CHARACTERISTICS (continued)

( $V_{IN} = V_{OUT} + 1V$ ,  $\overline{SHDN} = IN$ ,  $T_A = -40^{\circ}C$  to  $+85^{\circ}C$ , unless otherwise noted.) (Note 1)

PARAMETER	SYMBOL	CONDITIONS	MIN	TYP	MAX	UNITS
<b>SHUTDOWN</b>						
Shutdown Supply Current		$\overline{SHDN} = GND$ , $V_{IN} = 5.5V$		0.1	2	$\mu A$
$\overline{SHDN}$ Input Threshold	$V_{IH}$	$2.5V \leq V_{IN} \leq 5.5V$	1.6			V
	$V_{IL}$	$2.5V \leq V_{IN} \leq 5.5V$			0.6	V
$\overline{SHDN}$ Input Bias Current		$\overline{SHDN} = IN$ or $GND$		10	100	nA
OUT Discharge Resistance in Shutdown		$\overline{SHDN} = GND$		650	1100	$\Omega$
<b>POK (MAX8888 ONLY)</b>						
POK Trip Level, Referred to OUT Set Point		$V_{OUT}$ falling (1% typical hysteresis)	90	92.5	95	%
Operating IN Voltage Range for Valid POK			1.0		5.5	V
POK Output Voltage Low	$V_{OL}$	$I_{SINK} = 1mA$			0.1	V
POK Output Leakage Current		$V_{POK} = 5.5V$ , $\overline{SHDN} = IN$			100	nA
<b>THERMAL PROTECTION</b>						
Thermal Shutdown Temperature				170		$^{\circ}C$
Thermal Shutdown Hysteresis				20		$^{\circ}C$

**Note 1:** All parts are 100% tested at  $T_A = +25^{\circ}C$ . Limits over the operating temperature range are guaranteed by design.

**Note 2:** Typical and maximum dropout voltage for different output voltages are shown in the *Typical Operating Characteristics* curves.

## Typical Operating Characteristics

(Typical Operating Circuit,  $T_A = +25^{\circ}C$ , unless otherwise noted.)

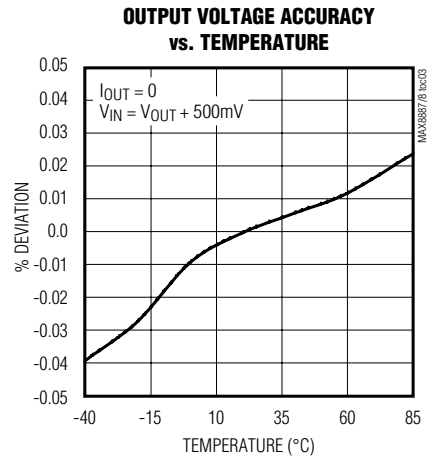
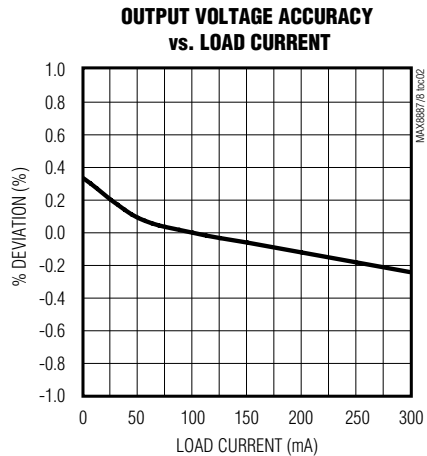
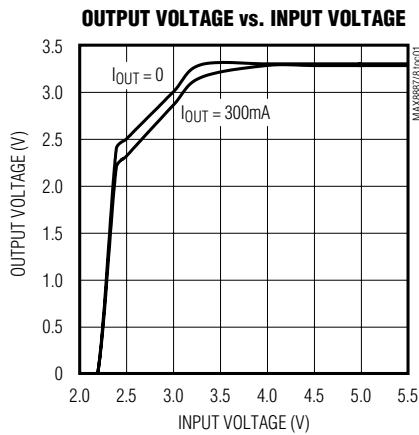

# Low-Dropout, 300mA Linear Regulators in SOT23

## Typical Operating Characteristics (continued)

(Typical Operating Circuit,  $T_A = +25^\circ\text{C}$ , unless otherwise noted.)

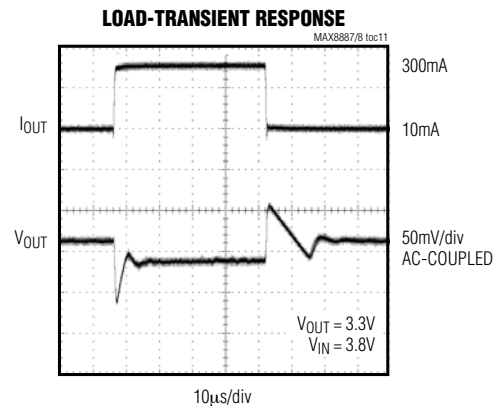
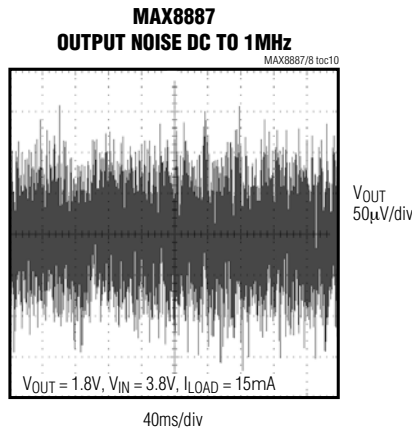
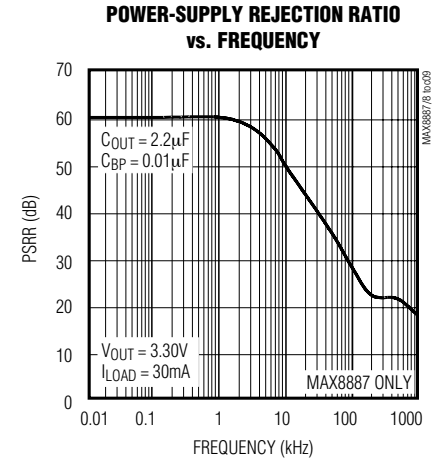
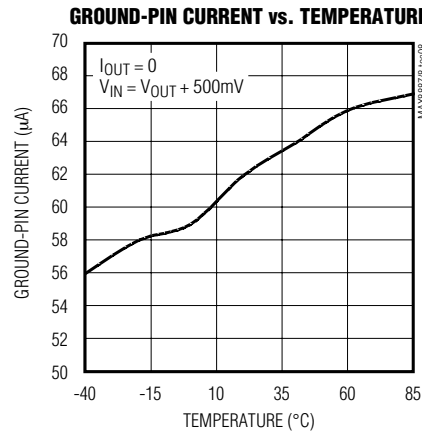
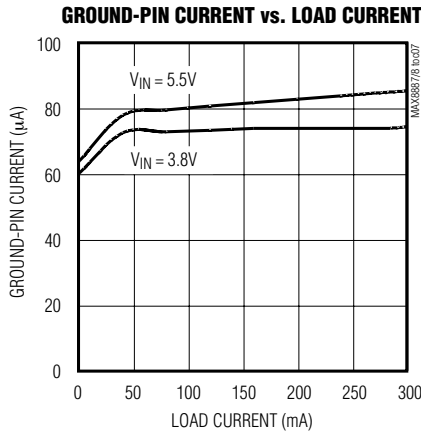
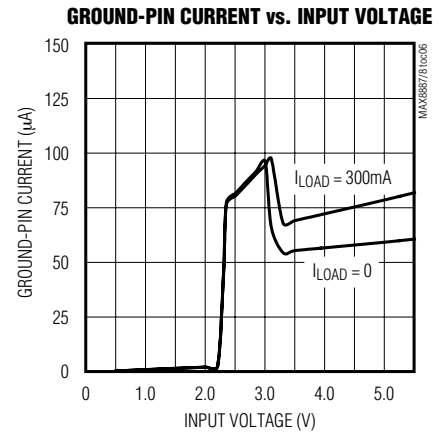
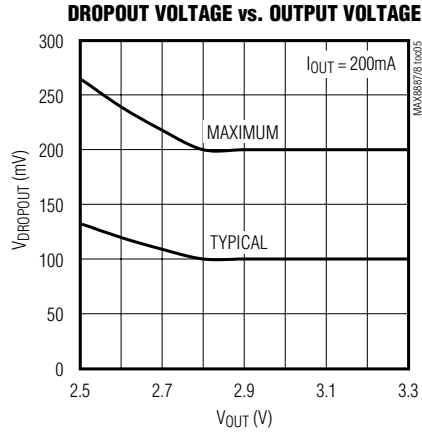
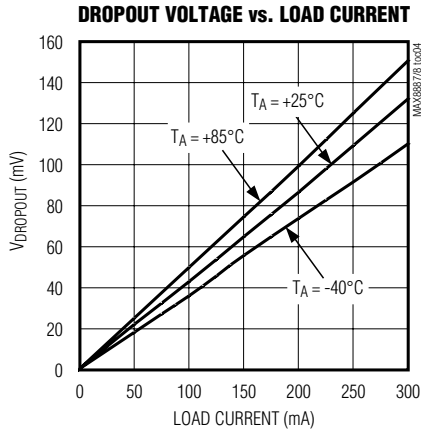

# Low-Dropout, 300mA Linear Regulators in SOT23

## Typical Operating Characteristics (continued)

(Typical Operating Circuit,  $T_A = +25^\circ\text{C}$ , unless otherwise noted.)

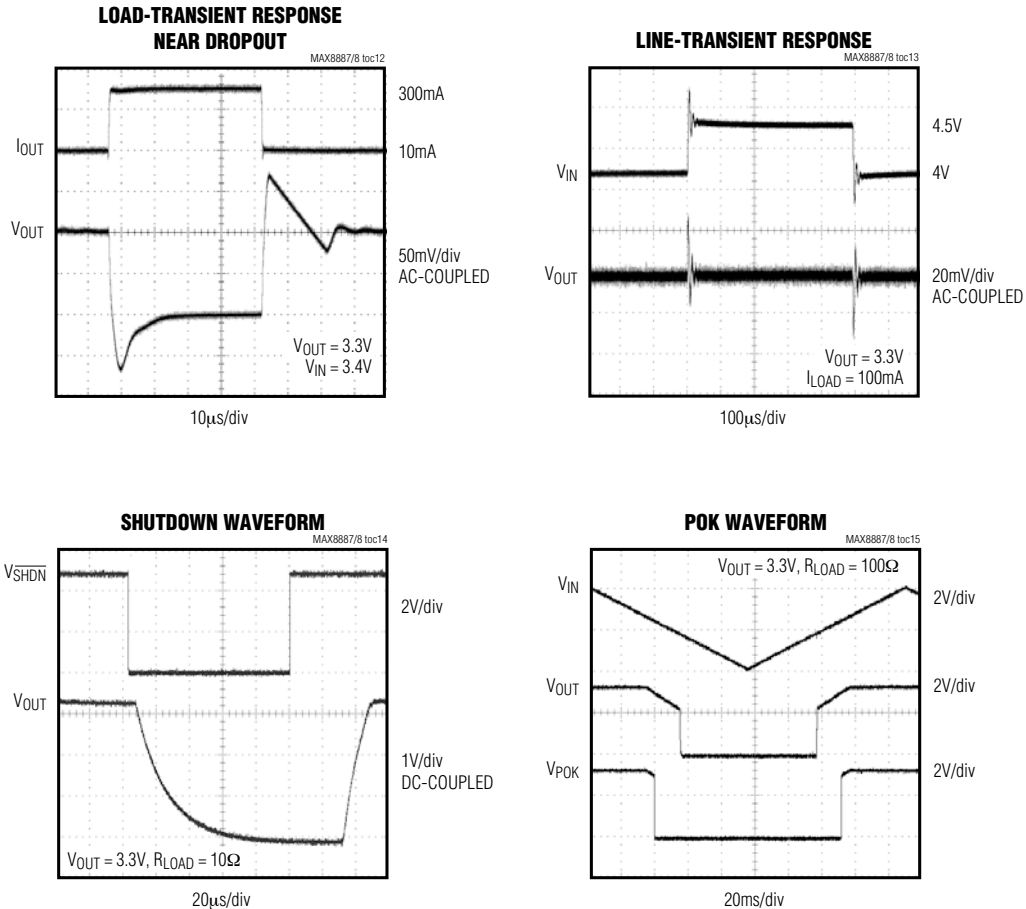

MAX8887/MAX8888

## Pin Description

MAX8887	MAX8888	NAME	FUNCTION
1	1	IN	Regulator Input. Supply voltage can range from 2.5V to 5.5V. Bypass with 2.2 $\mu\text{F}$ capacitor to GND (see the <i>Capacitor Selection and Regulator Stability</i> section).
2	2	GND	Ground
3	3	$\overline{\text{SHDN}}$	Active-Low Shutdown Input. A logic low reduces the supply current to below 0.1 $\mu\text{A}$ . In shutdown, POK and OUT are driven low. Connect to IN for normal operation.
—	4	POK	Open-Drain Active-Low POK Output. POK remains low while the output voltage ( $V_{OUT}$ ) is below the reset threshold. Connect a 100k $\Omega$ pullup resistor to OUT to obtain a logic level output. POK is driven low in shutdown. If not used, leave this pin unconnected.
4	—	BP	Reference Bypass. Bypass with a low-leakage 0.01 $\mu\text{F}$ ceramic capacitor.
5	5	OUT	Regulator Output. Sources up to 300mA guaranteed. Bypass with 2.2 $\mu\text{F}$ (<0.2 $\Omega$ typical ESR) ceramic capacitor to GND.

# Low-Dropout, 300mA Linear Regulators in SOT23

## Detailed Description

The MAX8887/MAX8888 are low-dropout, low-quiescent-current linear regulators designed primarily for battery-powered applications. The devices supply loads up to 300mA and are available in several fixed output voltages in the 1.5V to 3.3V range. The MAX8887 is optimized for low-noise operation, while the MAX8888 includes an open-drain POK output flag. As illustrated in Figure 1, the MAX8888 consists of a 1.25V reference, error amplifier, p-channel pass transistor, and internal feedback voltage divider.

### Internal p-Channel Pass Transistor

The MAX8887/MAX8888 feature a  $0.5\Omega$  p-channel MOSFET pass transistor. Unlike similar designs using PNP pass transistors, p-channel MOSFETs require no base drive, which reduces quiescent current. PNP-based regulators also waste considerable current in dropout when the pass transistor saturates and uses high base drive currents under large loads. The MAX8887/MAX8888 do not suffer from these problems and consume only  $55\mu\text{A}$  of quiescent current under heavy loads as well as in dropout.

### Output Voltage Selection

The MAX8887/MAX8888 are supplied with various factory-set output voltages ranging from 1.5V to 3.3V. The part number's two-digit suffix identifies the nominal output voltage. For example, the MAX8887EZX33 has a pre-set output voltage of 3.3V (see the *Ordering Information*).

### Shutdown

Drive  $\overline{\text{SHDN}}$  low to enter shutdown. During shutdown, the output is disconnected from the input and supply current drops to  $0.1\mu\text{A}$ . When in shutdown, POK and OUT are driven low.  $\overline{\text{SHDN}}$  can be pulled as high as 6V, regardless of the input and output voltages.

### Power-OK Output

The power-OK output (POK) pulls low when OUT is less than 93% of the nominal regulation voltage. Once OUT exceeds 93% of the nominal voltage, POK goes high impedance. POK is an open-drain n-channel output. To obtain a logic level output, connect a pullup resistor from POK to OUT. A  $100\text{k}\Omega$  resistor works well for most applications. POK can be used as a power-on-reset (POR) signal to a microcontroller ( $\mu\text{C}$ ) or to drive other logic. Adding a capacitor from POK to ground creates POK delay. When the MAX8887 is shut down, POK is held low independent of the output voltage. If unused, leave POK grounded or unconnected.

### Current Limit

The MAX8887/MAX8888 monitor and control the pass transistor's gate voltage, limiting the output current to 0.8A (typ). This current limit is reduced to 500mA (typ)

when the output voltage is below 93% of the nominal value to provide foldback current limiting.

### Thermal Overload Protection

Thermal overload protection limits total power dissipation in the MAX8887/MAX8888. When the junction temperature exceeds  $T_J = +170^\circ\text{C}$ , a thermal sensor turns off the pass transistor, allowing the device to cool. The thermal sensor turns the pass transistor on again after the junction temperature cools by  $20^\circ\text{C}$ , resulting in a pulsed output during continuous thermal overload conditions. Thermal overload protection protects the MAX8887/MAX8888 in the event of fault conditions. For continuous operation, do not exceed the absolute maximum junction-temperature rating of  $T_J = +150^\circ\text{C}$ .

### Operating Region and Power Dissipation

The MAX8887/MAX8888's maximum power dissipation depends on the thermal resistance of the IC package and circuit board. The temperature difference between the die junction and ambient air, and the rate of air flow. The power dissipated in the device is  $P = I_{\text{OUT}} \times (V_{\text{IN}} - V_{\text{OUT}})$ . The maximum allowed power dissipation is 727mW or:

$$P_{\text{MAX}} = (T_{\text{J(MAX)}} - T_{\text{A}}) / (\theta_{\text{JC}} + \theta_{\text{CA}})$$

where  $T_{\text{J(MAX)}} - T_{\text{A}}$  is the temperature difference between the MAX8887/MAX8888 die junction and the surrounding air;  $\theta_{\text{JC}}$  is the thermal resistance from the junction to the case; and  $\theta_{\text{CA}}$  is the thermal resistance from the case through PC board, copper traces, and other materials to the surrounding air.

Refer to Figure 2 for the MAX8887/MAX8888 valid operating region.

### Noise Reduction

For the MAX8887 only, an external  $0.01\mu\text{F}$  bypass capacitor at BP creates a lowpass filter for noise reduction. The MAX8887 exhibits  $42\mu\text{VRMS}$  of output voltage noise with  $C_{\text{BP}} = 0.01\mu\text{F}$  and  $C_{\text{OUT}} = 2.2\mu\text{F}$  (see the *Typical Operating Characteristics*).

## Applications Information

### Capacitor Selection and Regulator Stability

Connect a  $2.2\mu\text{F}$  ceramic capacitor between IN and ground and a  $2.2\mu\text{F}$  ceramic capacitor between OUT and ground. The input capacitor ( $C_{\text{IN}}$ ) lowers the source impedance of the input supply. Reduce noise and improve load-transient response, stability, and power-supply rejection by using a larger ceramic output capacitor such as  $4.7\mu\text{F}$ .

The output capacitor's ( $C_{\text{OUT}}$ ) equivalent series resistance (ESR) affects stability and output noise. Use output capacitors with an ESR of  $0.1\Omega$  or less to ensure

# Low-Dropout, 300mA Linear Regulators in SOT23

MAX8887/MAX8888

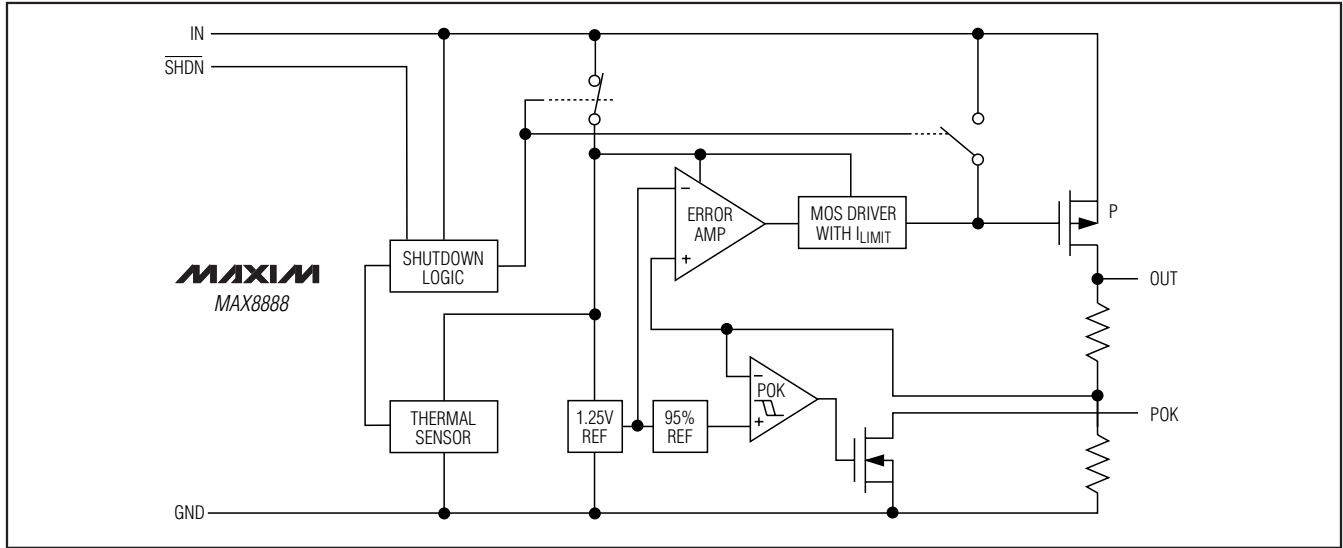

Figure 1. Functional Diagram

stability and optimum transient response. Surface-mount ceramic capacitors have very low ESR and are commonly available in values up to 10µF. Connect C<sub>IN</sub> and C<sub>OUT</sub> as close to the MAX8887/MAX8888 as possible to minimize the impact of PC board trace inductance.

### Noise, PSRR, and Transient Response

The MAX8887/MAX8888 are designed to operate with low dropout voltages and low quiescent currents in battery-powered systems while still maintaining excellent noise, transient response, and AC rejection. See the *Typical Operating Characteristics* for a plot of power-supply rejection ratio (PSRR) versus frequency. When operating from noisy sources, improved supply-noise rejection and transient response can be achieved by increasing the values of the input and output bypass capacitors and through passive filtering techniques.

### Input-Output (Dropout) Voltage

A regulator's minimum input-to-output voltage differential (dropout voltage) determines the lowest usable supply voltage at which the output is regulated. In battery-powered systems, this determines the useful end-of-life battery voltage. The MAX8887/MAX8888 use a p-channel MOSFET pass transistor. Its dropout voltage is a function of drain-to-source on-resistance (R<sub>DS(ON)</sub>) multiplied by the load current (see the *Typical Operating Characteristics*).

$$V_{DROPOUT} = V_{IN} - V_{OUT} = R_{DS(ON)} \times I_{OUT}$$

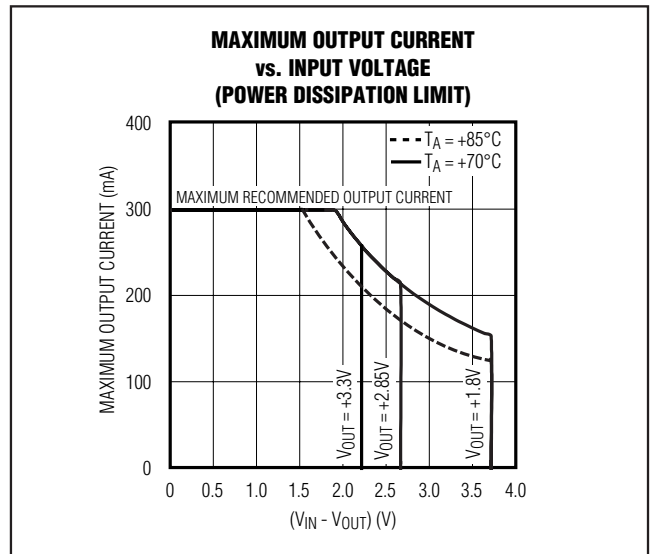

Figure 2. Power Operating Regions: Maximum Output Current vs. Input Voltage

# Low-Dropout, 300mA Linear Regulators in SOT23

## Chip Information

TRANSISTOR COUNT: 620  
PROCESS: BICMOS

## Package Information

For the latest package outline information and land patterns, go to [www.maxim-ic.com/packages](http://www.maxim-ic.com/packages). Note that a "+", "#", or "-" in the package code indicates RoHS status only. Package drawings may show a different suffix character, but the drawing pertains to the package regardless of RoHS status.

PACKAGE TYPE	PACKAGE CODE	DOCUMENT NO.
5 SOT23	Z5-1	<a href="#">21-0113</a>

# Low-Dropout, 300mA Linear Regulators in SOT23

## Revision History

REVISION NUMBER	REVISION DATE	DESCRIPTION	PAGES CHANGED
0	12/00	Initial release	—
1	12/01	Revised <i>Output Voltage Selection</i> section.	6
2	6/04	Revised <i>Absolute Maximum Ratings</i> .	2
3	11/06	Updated <i>Ordering Information</i> and package outlines.	1, 8
4	7/09	Revised <i>Ordering Information</i> .	1

MAX8887/MAX8888

Maxim cannot assume responsibility for use of any circuitry other than circuitry entirely embodied in a Maxim product. No circuit patent licenses are implied. Maxim reserves the right to change the circuitry and specifications without notice at any time.

9 \_\_\_\_\_ **Maxim Integrated Products, 120 San Gabriel Drive, Sunnyvale, CA 94086 408-737-7600**

## Looking for pricing, stock, or lifecycle information?

Click below to explore more details on WIN SOURCE:

- ⊖ [View MAX8887EZK33+T on WIN SOURCE](#)
- ⊖ [Maxim Integrated Information](#)

## Optimize Your Supply Chain with WIN SOURCE Solutions

- ✓ Global Sourcing Solution
- ✓ Obsolete Management
- ✓ Cost Control Management
- ✓ Shortage Management
- ✓ Alternative Solution
- ✓ Excess Inventory Management