



**THE DATASHEET OF  
MAX8934CETI+T**



# MAX8934A–MAX8934E

## Dual-Input Linear Chargers, Smart Power Selector with Advanced Battery Temperature Monitoring

### General Description

The MAX8934\_ dual-input Li+/Li-Poly linear battery chargers with Smart Power Selector™ safely charge a single Li+/Li-Poly cell in accordance with JEITA recommendations. The MAX8934\_ monitors the battery temperature (TBATT) while charging, and automatically adjusts the fast-charge current and charge termination voltage as the battery temperature varies. The MAX8934\_ also monitors the battery temperature while the battery is discharging, and provides a warning flag ( $\overline{OT}$ ) to the system in the event that the battery is over temperature. Two safety profiles are supported (see Figure 6 for details). An ultra-low I<sub>Q</sub>, always-on LDO provides an additional 3.3V supply for system power.

The MAX8934\_ operates with either separate inputs for USB and AC adapter power\*, or from a single input that accepts both. All power switches for charging and switching the load between battery and external power are included on-chip. No external MOSFETs are required.

The MAX8934\_ features a Smart Power Selector to make the best use of limited USB or adapter power. Input current limit and battery charge current limit are independently set. Input power not used by the system charges the battery. Charge current limit and DC current limit can be set up to 1.5A and 2A, respectively, while USB input current can be set to 100mA or 500mA for the MAX8934A/MAX8934B/MAX8934C/MAX8934E and up to 1.5A (max) for the MAX8934D. Automatic input selection switches the system load from battery to external power.

The MAX8934A provides a SYS output voltage of 5.3V, while the MAX8934B–MAX8934E provides a SYS output voltage of 4.35V.

Other features include overvoltage protection (OVP), open-drain charge status and fault outputs, power-OK monitors, charge timers, and a battery thermistor monitor. Additionally, on-chip thermal limiting reduces the battery charge-rate to prevent charger overheating. The MAX8934\_ is available in a 28-pin, 4mm x 4mm, TQFN package.

### Applications

PDAs, Palmtop, and Wireless Handhelds  
 Portable Media, MP3 Players, and PNDs  
 Digital Still Cameras and Digital Video Cameras  
 Handheld Game Systems

Smart Power Selector is a trademark of Maxim Integrated Products, Inc.

\*Protected by U.S. Patent #6,507,172.

### Features

- ◆ Li+ Charger with Smart Power Selector, No External MOSFETs Needed
- ◆ Monitors Battery Temperature and Adjusts Charge Current and Termination Voltage Automatically per JEITA Recommendations
- ◆  $\overline{OT}$  Flags System of a Hot Battery During Discharge
- ◆ Ultra-Low I<sub>Q</sub>, Always-On 3.3V LDO
- ◆ Common or Separate USB and Adapter Inputs
- ◆ Automatic Adapter/USB/Battery Switchover
- ◆ Load Peaks in Excess of Adapter Rating are Supported by Battery
- ◆ Input OVP to 16V (DC) and 9V (USB)
- ◆ 40mΩ SYS-to-BATT Switch
- ◆ Thermal Regulation Prevents Overheating
- ◆ 4.35V or 5.3V SYS Regulation Voltage
- ◆ 1.5A (max) USB Input Current Limit (MAX8934D)

### Ordering Information

PART	TEMP RANGE	PIN-PACKAGE
MAX8934AETI+	-40°C to +85°C	28 Thin QFN-EP**

+Denotes a lead(Pb)-free/RoHS-compliant package.

\*\*EP = Exposed pad.

Ordering Information continued and Selector Guide appears at end of data sheet.

### Typical Operating Circuit

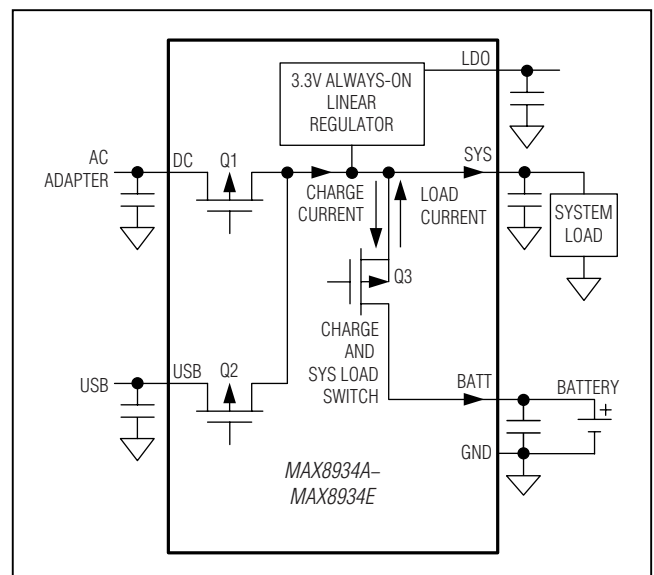

For pricing, delivery, and ordering information, please contact Maxim Direct at 1-888-629-4642, or visit Maxim's website at [www.maximintegrated.com](http://www.maximintegrated.com).

# MAX8934A–MAX8934E

## Dual-Input Linear Chargers, Smart Power Selector with Advanced Battery Temperature Monitoring

### ABSOLUTE MAXIMUM RATINGS

DC, PEN1 to GND .....	-0.3V to +16V	BATT Continuous Current (total in two pins).....	2.4ARMS
USB to GND .....	-0.3V to +9V	LDO Continuous Current.....	50mARMS
V <sub>L</sub> to GND .....	-0.3V to +4V	LDO Short-Circuit Duration .....	Continuous
LDO to GND .....	-0.3V to the lower of +4V and (V <sub>SYS</sub> + 0.3V)	Continuous Power Dissipation (T <sub>A</sub> = +70°C)	
THMEN, THMSW to GND .....	-0.3V to +(V <sub>LDO</sub> + 0.3V)	Single-Layer Board	
THM to GND.....	-0.3V to (V <sub>THMSW</sub> + 0.3V)	(derate 20.8mW/°C above +70°C).....	1666.7mW
PSET, ISET, CT to GND.....	-0.3V to (V <sub>L</sub> + 0.3V)	Multilayer Board	
BATT, SYS, CEN, CHG, OT, DOK,		(derate 28.6mW/°C above +70°C).....	2285.7mW
UOK, FLT, DONE, USUS, PEN2 to GND.....	-0.3V to +6V	Operating Temperature Range.....	-40°C to +85°C
EP (Exposed Pad) to GND.....	-0.3V to +0.3V	Junction Temperature .....	-40°C to +125°C
DC Continuous Current (total in two pins) .....	2.4ARMS	Storage Temperature .....	-65°C to +150°C
SYS Continuous Current (total in two pins).....	2.4ARMS	Lead Temperature (soldering, 10s) .....	+300°C
USB Continuous Current (total in two pins) .....	2.0ARMS	Soldering Temperature (reflow) .....	+260°C

Stresses beyond those listed under "Absolute Maximum Ratings" may cause permanent damage to the device. These are stress ratings only, and functional operation of the device at these or any other conditions beyond those indicated in the operational sections of the specifications is not implied. Exposure to absolute maximum rating conditions for extended periods may affect device reliability.

### ELECTRICAL CHARACTERISTICS

(V<sub>DC</sub> = V<sub>PEN1</sub> = V<sub>PEN2</sub> = 5V, CEN = USUS = THMEN = GND, V<sub>BATT</sub> = 4V, V<sub>THM</sub> = 1.65V, USB, THMSW, CHG, DONE, OT, DOK, UOK, FLT are unconnected, C<sub>CT</sub> = 0.068μF, T<sub>A</sub> = -40°C to +85°C, unless otherwise noted. Typical values are at T<sub>A</sub> = +25°C.) (Note 1)

PARAMETER	CONDITIONS	MIN	TYP	MAX	UNITS	
<b>DC-to-SYS PREREGULATOR</b>						
DC Operating Voltage Range		4.1		6.6	V	
DC Withstand Voltage	V <sub>BATT</sub> = V <sub>SYS</sub> = 0V			14	V	
DC Undervoltage Threshold	When V <sub>DOK</sub> goes low, V <sub>DC</sub> rising, 500mV hysteresis	3.95	4.0	4.05	V	
DC Overvoltage Threshold	When V <sub>DOK</sub> goes high, V <sub>DC</sub> rising, 360mV hysteresis	6.8	6.9	7.0	V	
DC Operating Supply Current	I <sub>SYS</sub> = I <sub>BATT</sub> = 0mA, V <sub>CEN</sub> = 0V		1	2	mA	
	I <sub>SYS</sub> = I <sub>BATT</sub> = 0mA, V <sub>CEN</sub> = 5V		0.8	1.5		
DC Suspend Current	V <sub>DC</sub> = V <sub>CEN</sub> = V <sub>USUS</sub> = 5V, V <sub>PEN1</sub> = 0V		195	340	μA	
DC-to-SYS On-Resistance	I <sub>SYS</sub> = 400mA, V <sub>CEN</sub> = 5V		0.2	0.35	Ω	
DC to BATT Dropout Voltage	When SYS regulation and charging stops, V <sub>DC</sub> falling, 150mV hysteresis	10	50	90	mV	
DC Current Limit	V <sub>DC</sub> = 6V, V <sub>SYS</sub> = 5V, T <sub>A</sub> = +25°C (MAX8934A);	RPSET = 1.5kΩ	1800	2000	2200	mA
		RPSET = 3kΩ	900	1000	1100	
	V <sub>DC</sub> = 5V, V <sub>SYS</sub> = 4V, T <sub>A</sub> = +25°C (MAX8934B–MAX8934E)	V <sub>PEN1</sub> = 0V, V <sub>PEN2</sub> = 5V (500mA USB mode)	450	475	500	
		V <sub>PEN1</sub> = V <sub>PEN2</sub> = 0V (100mA USB mode)	80	95	100	
PSET Resistance Range		1.5		6.3	kΩ	
SYS Regulation Voltage	V <sub>DC</sub> = 6V, I <sub>SYS</sub> = 1mA to 1.75A, V <sub>CEN</sub> = 5V	MAX8934A	5.2	5.3	5.4	V
		MAX8934B–MAX8934E	4.29	4.35	4.4	
Input Current Soft-Start Time	Connecting DC with USB not present		1.5		ms	
	Connecting DC with USB present		50		μs	
Thermal-Limit Temperature	Die temperature at when the charging current and input current limits are reduced		100		°C	

# MAX8934A–MAX8934E

## Dual-Input Linear Chargers, Smart Power Selector with Advanced Battery Temperature Monitoring

### ELECTRICAL CHARACTERISTICS (continued)

( $V_{DC} = V_{PEN1} = V_{PEN2} = 5V$ ,  $\overline{CEN} = USUS = THMEN = GND$ ,  $V_{BATT} = 4V$ ,  $V_{THM} = 1.65V$ , USB, THMSW,  $\overline{CHG}$ ,  $\overline{DONE}$ ,  $\overline{OT}$ ,  $\overline{DOK}$ ,  $\overline{UOK}$ ,  $\overline{FLT}$  are unconnected,  $C_{CT} = 0.068\mu F$ ,  $T_A = -40^\circ C$  to  $+85^\circ C$ , unless otherwise noted. Typical values are at  $T_A = +25^\circ C$ .) (Note 1)

PARAMETER	CONDITIONS		MIN	TYP	MAX	UNITS
Thermal-Limit Gain	I <sub>SYS</sub> reduction with die temperature (above +100°C)			5		%/C
V <sub>L</sub> Voltage	I <sub>VL</sub> = 0 to 5mA, USB = unconnected		3	3.3	3.6	V
<b>USB-TO-SYS PREREGULATOR</b>						
USB Operating Voltage Range			4.1		6.6	V
USB Withstand Voltage	V <sub>BATT</sub> = V <sub>SYS</sub> = 0V				8	V
USB Undervoltage Threshold	When $\overline{UOK}$ goes low, V <sub>USB</sub> rising, 500mV hysteresis		3.95	4.0	4.05	V
USB Overvoltage Threshold	When $\overline{UOK}$ goes high, V <sub>USB</sub> rising, 360mV hysteresis		6.8	6.9	7.0	V
USB Operating Supply Current	I <sub>SYS</sub> = I <sub>BATT</sub> = 0mA, $\overline{V_{CEN}} = V_{PEN2} = 0V$			1	2	mA
	I <sub>SYS</sub> = I <sub>BATT</sub> = 0mA, $\overline{V_{CEN}} = 5V$ , V <sub>PEN2</sub> = 0V			0.9	1.5	
USB Suspend Current	DC = unconnected, V <sub>USB</sub> = $\overline{V_{CEN}} = V_{USUS} = 5V$			190	340	μA
USB to SYS On-Resistance	DC unconnected, V <sub>USB</sub> = $\overline{V_{CEN}} = 5V$ , I <sub>SYS</sub> = 400mA			0.22	0.33	Ω
USB-to-BATT Dropout Voltage	When SYS regulation and charging stops, V <sub>USB</sub> falling, 150mV hysteresis		10	50	90	mV
USB Current Limit (See Tables 2a and 2b for Input Source Control)	DC unconnected, V <sub>USB</sub> = 5V, T <sub>A</sub> = +25°C	MAX8934D only, R <sub>PSET</sub> = 2kΩ	1350	1500	1650	mA
		V <sub>PEN1</sub> = 0V, V <sub>PEN2</sub> = 5V	450	475	500	
		V <sub>PEN1</sub> = V <sub>PEN2</sub> = 0V	80	95	100	
SYS Regulation Voltage	DC unconnected, V <sub>USB</sub> = 6V, V <sub>PEN2</sub> = 5V, I <sub>SYS</sub> = 1mA to 400mA, $\overline{V_{CEN}} = 5V$	MAX8934A	5.2	5.3	5.4	V
		MAX8934B/MAX8934C/MAX8934E	4.29	4.35	4.4	
	DC unconnected, V <sub>USB</sub> = 6V, V <sub>PEN2</sub> = 5V, I <sub>SYS</sub> = 1mA to 1.2A, $\overline{V_{CEN}} = 5V$	MAX8934D	4.29	4.35	4.4	
Input Limiter Soft-Start Time	Input current ramp time			50		μs
Thermal-Limit Temperature	Die temperature at when the charging current and input current limits are reduced			100		°C
Thermal-Limit Gain	I <sub>SYS</sub> reduction with die temperature (above +100°C)			5		%/°C
V <sub>L</sub> Voltage	DC unconnected, V <sub>USB</sub> = 5V, I <sub>VL</sub> = 0 to 5mA		3	3.3	3.6	V
<b>LDO LINEAR REGULATOR</b>						
LDO Output Voltage	DC unconnected, V <sub>USB</sub> = 5V, I <sub>LDO</sub> = 0mA		3.234	3.3	3.366	V
	V <sub>DC</sub> = 5V, USB unconnected, I <sub>LDO</sub> = 0mA		3.234	3.3	3.366	
	DC and USB unconnected, V <sub>BATT</sub> = 4V, I <sub>LDO</sub> = 0mA		3.234	3.3	3.366	
LDO Load Regulation	I <sub>LDO</sub> = 0 to 30mA			0.003		%/mA

# MAX8934A–MAX8934E

## Dual-Input Linear Chargers, Smart Power Selector with Advanced Battery Temperature Monitoring

### ELECTRICAL CHARACTERISTICS (continued)

( $V_{DC} = V_{PEN1} = V_{PEN2} = 5V$ ,  $\overline{CEN} = USUS = THMEN = GND$ ,  $V_{BATT} = 4V$ ,  $V_{THM} = 1.65V$ ,  $USB, THMSW, \overline{CHG}, \overline{DONE}, \overline{OT}, \overline{DOK}, \overline{UOK}, \overline{FLT}$  are unconnected,  $C_{CT} = 0.068\mu F$ ,  $T_A = -40^\circ C$  to  $+85^\circ C$ , unless otherwise noted. Typical values are at  $T_A = +25^\circ C$ .) (Note 1)

PARAMETER	CONDITIONS		MIN	TYP	MAX	UNITS
<b>BATTERY CHARGER</b>						
BATT-to-SYS On-Resistance	$V_{DC} = 0V, V_{BATT} = 4.2V, I_{SYS} = 1A$			0.04	0.08	$\Omega$
BATT-to-SYS Reverse Regulation Voltage	$V_{PEN1} = V_{PEN2} = 0V, I_{SYS} = 200mA$		50	75	105	mV
BATT Regulation Voltage—Safety Region 1 (MAX8934A)	$I_{BATT} = 0mA$	$T_A = +25^\circ C, V_{THM\_T1} < V_{THM} < V_{THM\_T3}$	4.175	4.2	4.225	V
		$T_A = 0^\circ C$ to $+85^\circ C, V_{THM\_T1} < V_{THM} < V_{THM\_T3}$	4.158	4.2	4.242	
		$T_A = +25^\circ C, V_{THM\_T3} < V_{THM} < V_{THM\_T4}$	4.05	4.075	4.1	
		$T_A = 0^\circ C$ to $+85^\circ C, V_{THM\_T3} < V_{THM} < V_{THM\_T4}$	4.034	4.075	4.1	
BATT Regulation Voltage—Safety Region 2	$I_{BATT} = 0mA$	$T_A = +25^\circ C, V_{THM\_T2} < V_{THM} < V_{THM\_T3}$	4.175	4.2	4.225	V
		$T_A = 0^\circ C$ to $+85^\circ C, V_{THM\_T2} < V_{THM} < V_{THM\_T3}$	4.158	4.2	4.242	
		$T_A = +25^\circ C, V_{THM\_T1} < V_{THM} < V_{THM\_T2}$ or $V_{THM\_T3} < V_{THM} < V_{THM\_T4}$	4.05	4.075	4.1	
		$T_A = 0^\circ C$ to $+85^\circ C, V_{THM\_T1} < V_{THM} < V_{THM\_T2}$ or $V_{THM\_T3} < V_{THM} < V_{THM\_T4}$	4.034	4.075	4.1	
BATT Recharge Threshold—Safety Region 1 (MAX8934A)	Change in $V_{BATT}$ from DONE to fast-charge restart	$V_{THM\_T1} < V_{THM} < V_{THM\_T3}$	-145	-104	-65	mV
		$V_{THM\_T3} < V_{THM} < V_{THM\_T4}$	-120	-80	-40	
BATT Recharge Threshold—Safety Region 2	Change in $V_{BATT}$ from DONE to fast-charge restart	$V_{THM\_T2} < V_{THM} < V_{THM\_T3}$	-145	-104	-65	mV
		$V_{THM\_T1} < V_{THM} < V_{THM\_T2}$ or $V_{THM\_T3} < V_{THM} < V_{THM\_T4}$	-120	-80	-40	
BATT Fast-Charge Current Range	$R_{ISET} = 10k\Omega$ to $2k\Omega$		0.3		1.5	A

# MAX8934A–MAX8934E

## Dual-Input Linear Chargers, Smart Power Selector with Advanced Battery Temperature Monitoring

### ELECTRICAL CHARACTERISTICS (continued)

( $V_{DC} = V_{PEN1} = V_{PEN2} = 5V$ ,  $\overline{CEN} = USUS = THMEN = GND$ ,  $V_{BATT} = 4V$ ,  $V_{THM} = 1.65V$ ,  $USB, THMSW, \overline{CHG}, \overline{DONE}, \overline{OT}, \overline{DOK}, \overline{UOK}, \overline{FLT}$  are unconnected,  $C_{CT} = 0.068\mu F$ ,  $T_A = -40^\circ C$  to  $+85^\circ C$ , unless otherwise noted. Typical values are at  $T_A = +25^\circ C$ .) (Note 1)

PARAMETER	CONDITIONS	MIN	TYP	MAX	UNITS	
BATT Charge Current Accuracy	$V_{SYS} = 5.5V$ , $V_{THM\_T2} < V_{THM} < V_{THM\_T4}$ (safety region 1) or $V_{THM\_T1} < V_{THM} < V_{THM\_T4}$ (safety region 2)	$R_{ISET} = 2k\Omega$	1350	1500	1650	mA
		$R_{ISET} = 4k\Omega$	675	750	825	
		$R_{ISET} = 10k\Omega$	270	300	330	
		$R_{ISET} = 2k\Omega$ , $V_{BATT} = 2.5V$ (prequal)	130	150	170	
		$R_{ISET} = 4k\Omega$ , $V_{BATT} = 2.5V$ (prequal)	50	75	100	
		$R_{ISET} = 10k\Omega$ , $V_{BATT} = 2.5V$ (prequal)		30		
	$V_{SYS} = 5.5V$ , $V_{THM\_T1} < V_{THM} < V_{THM\_T2}$ (safety region 1)	$R_{ISET} = 2k\Omega$	675	750	825	
		$R_{ISET} = 4k\Omega$	337.5	375	412.5	
		$R_{ISET} = 10k\Omega$	130	150	170	
		$R_{ISET} = 2k\Omega$ , $V_{BATT} = 2.5V$ (prequal)	130	150	170	
		$R_{ISET} = 4k\Omega$ , $V_{BATT} = 2.5V$ (prequal)	50	75	100	
		$R_{ISET} = 10k\Omega$ , $V_{BATT} = 2.5V$ (prequal)		30		
ISET Output Voltage	$R_{ISET} = 4k\Omega$ , $I_{BATT} = 500mA$ ( $V_{ISET} = 1.5V$ at full charge current) $V_{THM\_T2} < V_{THM} < V_{THM\_T4}$	0.9	1	1.1	V	
Charger Soft-Start Time	Charge-current ramp time		1.5		ms	
BATT Prequal Threshold	$V_{BATT}$ rising, 180mV hysteresis	2.9	3	3.1	V	
BATT Input Current	$V_{BATT} = 4.2V$ , $I_{LDO} = 0$	No DC or USB power connected, $THMEN = low$ , $\overline{VCEN} = 5V$		5	12	$\mu A$
		No DC or USB power connected, $THMEN = high$ , $\overline{VCEN} = 5V$		12	25	
		DC or USB power connected, $\overline{VCEN} = 5V$		0.003	2	
DONE Threshold as a Percentage of Fast-Charge Current	$I_{BATT}$ decreasing		10		%	

# MAX8934A–MAX8934E

## Dual-Input Linear Chargers, Smart Power Selector with Advanced Battery Temperature Monitoring

### ELECTRICAL CHARACTERISTICS (continued)

( $V_{DC} = V_{PEN1} = V_{PEN2} = 5V$ ,  $\overline{CEN} = USUS = THMEN = GND$ ,  $V_{BATT} = 4V$ ,  $V_{THM} = 1.65V$ ,  $USB, THMSW, \overline{CHG}, \overline{DONE}, \overline{OT}, \overline{DOK}, \overline{UOK}, \overline{FLT}$  are unconnected,  $C_{CT} = 0.068\mu F$ ,  $T_A = -40^\circ C$  to  $+85^\circ C$ , unless otherwise noted. Typical values are at  $T_A = +25^\circ C$ .) (Note 1)

PARAMETER	CONDITIONS	MIN	TYP	MAX	UNITS
Maximum Prequal Time	From $\overline{CEN}$ falling to end of prequal charge, $V_{BATT} = 2.5V$		30		min
Maximum Fast-Charge Time	From $\overline{CEN}$ falling to $\overline{FLT}$ falling		300		min
Maximum Top-Off Time	MAX8934A/MAX8934C/MAX8934E		15		s
	MAX8934B/MAX8934D		60		min
Timer Accuracy		-20		+20	%
Timer Extend Threshold	Percentage of fast-charge current below where the timer clock operates at half-speed		50		%
Timer Suspend Threshold	Percentage of fast-charge current below where timer clock pauses		20		%
<b>THERMISTOR MONITOR (Beta = 3477) (Note 2)</b>					
THM Cold No-Charge Threshold (T1)	$I_{CHG} = 0A$ , when charging is suspended, $2^\circ C$ hysteresis	-2.2	0	+2.4	$^\circ C$
		73.9	74.4	75.1	% of THMSW
THM Cold Threshold (T2)	$I_{CHG}$ reduced (safety region 1 only), $V_{BATT\_REG}$ reduced (safety region 2 only), $2^\circ C$ hysteresis	8	10	12	$^\circ C$
		64.5	65	65.5	% of THMSW
THM Hot Threshold (T3)	$V_{BATT\_REG}$ reduced (safety region 1), $2.5^\circ C$ hysteresis	42.8	45	47.5	$^\circ C$
		32.1	32.4	32.8	% of THMSW
THM Hot No-Charge Threshold (T4)	$I_{CHG} = 0mA$ , when charging is suspended, $3^\circ C$ hysteresis	57	60	63.5	$^\circ C$
		22.4	22.7	23	% of THMSW
THM Hot Overtemperature Threshold ( $\overline{TOT}$ )	$\overline{OT}$ asserts low, $5^\circ C$ hysteresis	71	75	80	$^\circ C$
		15.5	15.8	16	% of THMSW
<b>THERMISTOR MONITOR (Beta = 3964) (Note 3)</b>					
THM Cold No-Charge Threshold (T1)	$I_{CHG} = 0A$ , when charging is suspended, $2^\circ C$ hysteresis	-2.1	0	+2.4	$^\circ C$
		76.4	77.2	77.9	% of THMSW
THM Cold Threshold (T2)	$I_{CHG}$ reduced (safety region 1 only), $V_{BATT\_REG}$ reduced (safety region 2), $2^\circ C$ hysteresis	8.2	10	12	$^\circ C$
		66.2	67	67.6	% of THMSW

# MAX8934A–MAX8934E

## Dual-Input Linear Chargers, Smart Power Selector with Advanced Battery Temperature Monitoring

### ELECTRICAL CHARACTERISTICS (continued)

( $V_{DC} = V_{PEN1} = V_{PEN2} = 5V$ ,  $\overline{CEN} = USUS = THMEN = GND$ ,  $V_{BATT} = 4V$ ,  $V_{THM} = 1.65V$ ,  $USB, THMSW, \overline{CHG}, \overline{DONE}, \overline{OT}, \overline{DOK}, \overline{UOK}, \overline{FLT}$  are unconnected,  $C_{CT} = 0.068\mu F$ ,  $T_A = -40^\circ C$  to  $+85^\circ C$ , unless otherwise noted. Typical values are at  $T_A = +25^\circ C$ .) (Note 1)

PARAMETER	CONDITIONS		MIN	TYP	MAX	UNITS
THM Hot Threshold (T3)	VBATT_REG reduced, safety region 1, 2.5°C hysteresis		42.8	45	47.5	°C
			29.8	30	30.6	% of THMSW
THM Hot No-Charge Threshold (T4)	I <sub>CHG</sub> = 0mA, when charging is suspended, 3°C hysteresis		57	60	63.5	°C
			19.5	19.8	20.1	% of THMSW
THM Hot Overtemperature Threshold (T <sub>OT</sub> )	$\overline{OT}$ asserts low, 5°C hysteresis		71	75	80	°C
			12.6	12.9	13.1	% of THMSW
THM Input leakage	THM = GND or LDO	T <sub>A</sub> = +25°C	-1	+0.001	+1	μA
		T <sub>A</sub> = +85°C	0.01			
THMSW Output Leakage	THMSW = GND	T <sub>A</sub> = +25°C	-0.2	+0.001	+1	μA
		T <sub>A</sub> = +85°C	0.01			
THMSW Output Voltage High	Sourcing 1mA		V <sub>LDO</sub> - 0.05			V
<b>LOGIC I/O: PEN1, PEN2, CHG, FLT, DONE, DOK, UOK, USUS, THMEN)</b>						
Logic-Input Thresholds	High level		1.3			V
	Low level		0.4			
	Hysteresis		50			mV
Logic-Input Leakage Current	V <sub>IN</sub> = 0 to 5.5V	T <sub>A</sub> = +25°C	0.001		1	μA
		T <sub>A</sub> = +85°C	0.01			
Logic-Low Output Voltage	Sinking 1mA		25	100		mV
Logic-High Output Leakage Current	V <sub>OUT</sub> = 5.5V	T <sub>A</sub> = +25°C	0.001		1	μA
		T <sub>A</sub> = +85°C	0.01			

**Note 1:** Limits are 100% production tested at  $T_A = +25^\circ C$ . Limits over the operating temperature range are guaranteed by design.

**Note 2:** °C includes external NTC thermistor error. % of THMSW excludes thermistor beta error and external pullup error. NTC thermistor assumed to be 10kΩ nominal, part number Vishay NTHS0603N02N1002FF, external pullup resistor = 10kΩ.

**Note 3:** °C includes external NTC thermistor error. % of THMSW excludes thermistor beta error and external pullup error. NTC thermistor assumed to be 100kΩ ±1% nominal, part number Vishay NTHS0603N01N1003FF, external pullup resistor = 100kΩ ±1%.

# MAX8934A-MAX8934E

## Dual-Input Linear Chargers, Smart Power Selector with Advanced Battery Temperature Monitoring

### Typical Operating Characteristics

(MAX8934A,  $T_A = +25^\circ\text{C}$ , circuit of Figure 2,  $V_{DC} = 6\text{V}$ ,  $V_{BATT} = 3.6\text{V}$ , thermistor Beta = 3964, unless otherwise noted. Negative battery current indicates charging.)

**USB OPERATING SUPPLY CURRENT vs. USB VOLTAGE (CHARGER ENABLED)**

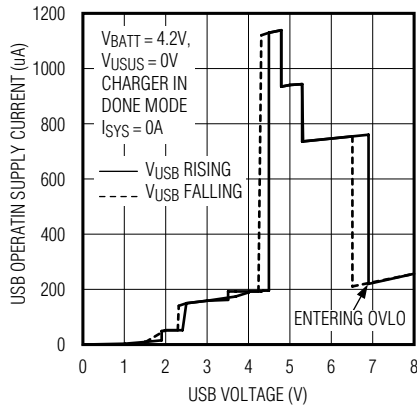

**USB OPERATING SUPPLY CURRENT vs. USB VOLTAGE (CHARGER DISABLED)**

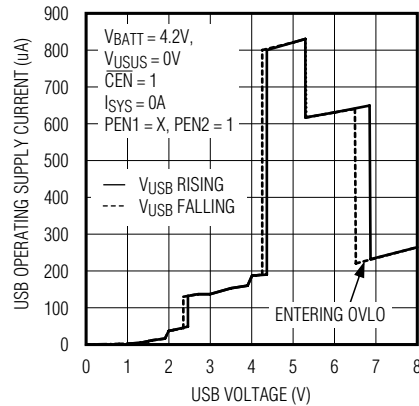

**USB SUSPEND CURRENT vs. USB VOLTAGE**

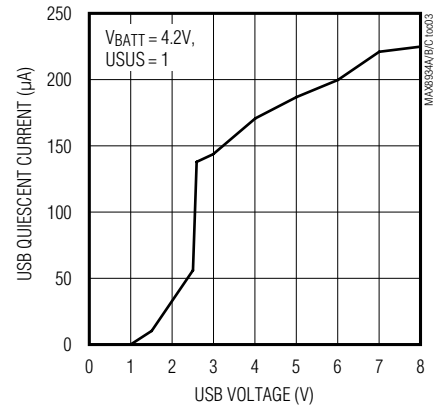

**BATTERY INPUT CURRENT vs. BATTERY VOLTAGE (USB DISCONNECTED)**

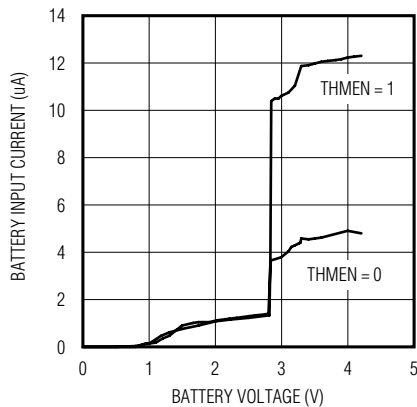

**BATTERY INPUT CURRENT vs. TEMPERATURE**

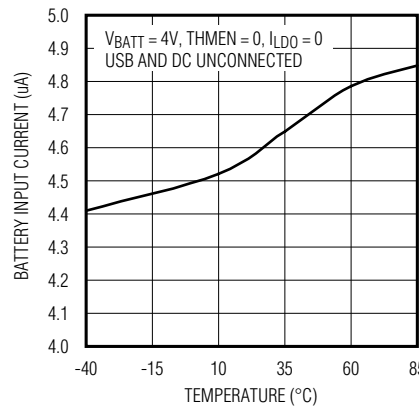

**CHARGE CURRENT vs. BATTERY VOLTAGE (100mA USB)**

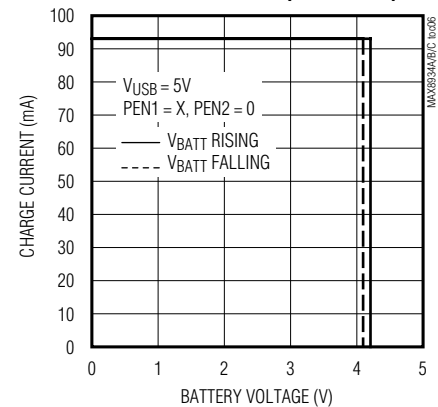

**CHARGE CURRENT vs. BATTERY VOLTAGE (500mA USB)**

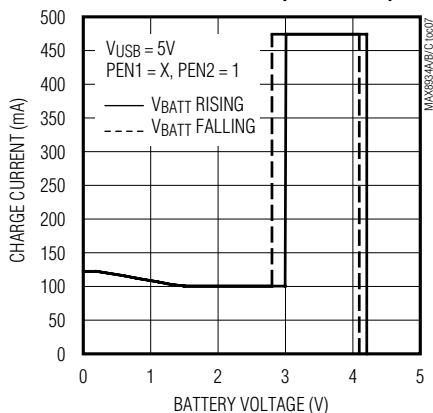

**CHARGE CURRENT vs. BATTERY VOLTAGE (1A DC)**

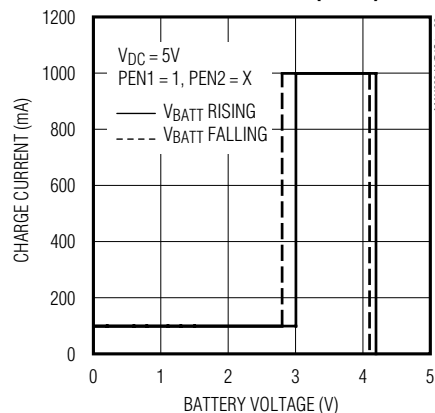

# MAX8934A-MAX8934E

## Dual-Input Linear Chargers, Smart Power Selector with Advanced Battery Temperature Monitoring

### Typical Operating Characteristics (continued)

(MAX8934A,  $T_A = +25^\circ\text{C}$ , circuit of Figure 2,  $V_{DC} = 6\text{V}$ ,  $V_{BATT} = 3.6\text{V}$ , thermistor Beta = 3964, unless otherwise noted. Negative battery current indicates charging.)

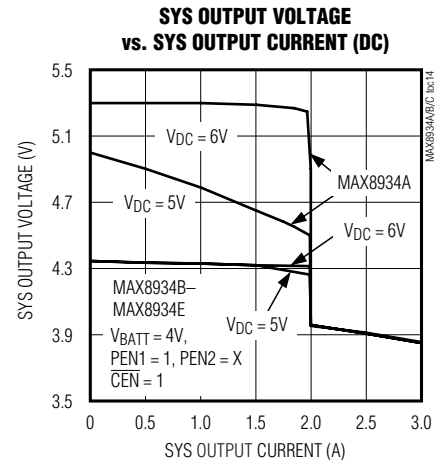
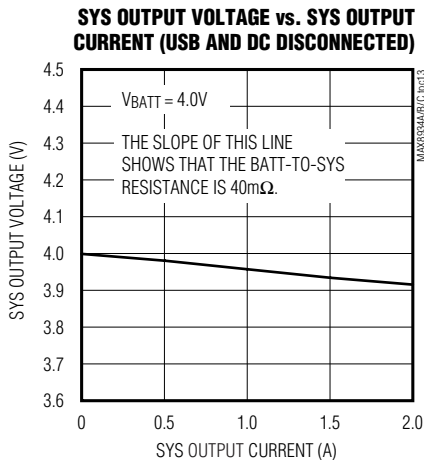
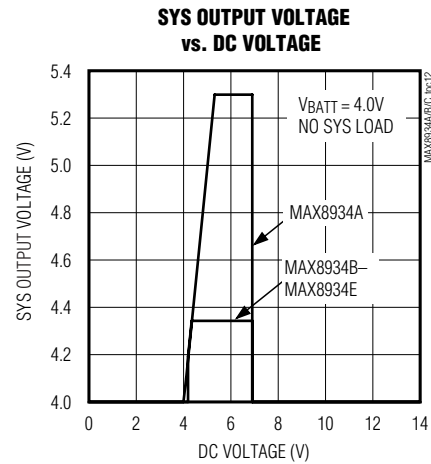
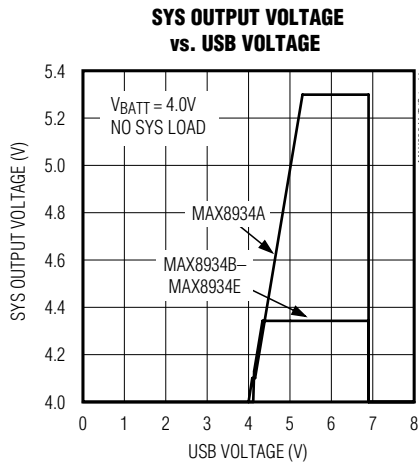
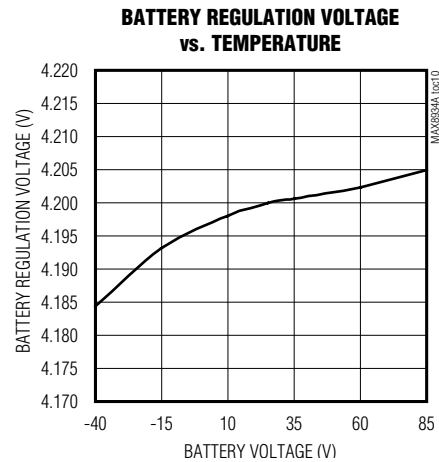
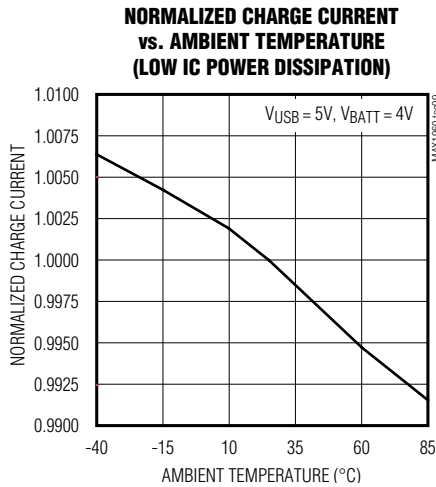

# MAX8934A–MAX8934E

## Dual-Input Linear Chargers, Smart Power Selector with Advanced Battery Temperature Monitoring

### Typical Operating Characteristics (continued)

(MAX8934A,  $T_A = +25^\circ\text{C}$ , circuit of Figure 2,  $V_{DC} = 6\text{V}$ ,  $V_{BATT} = 3.6\text{V}$ , thermistor Beta = 3964, unless otherwise noted. Negative battery current indicates charging.)

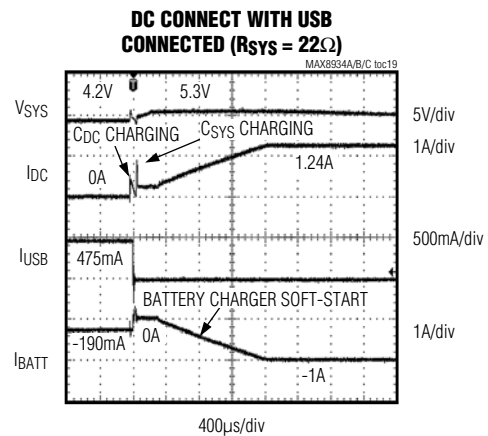
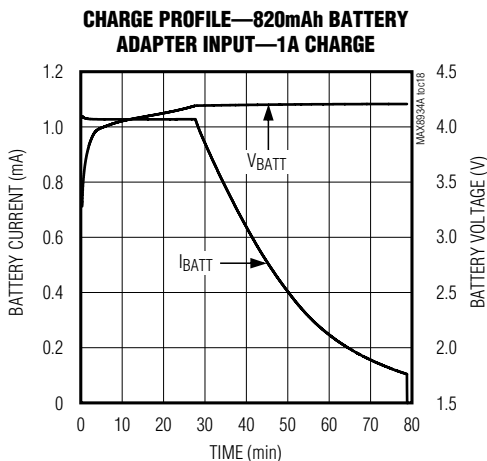
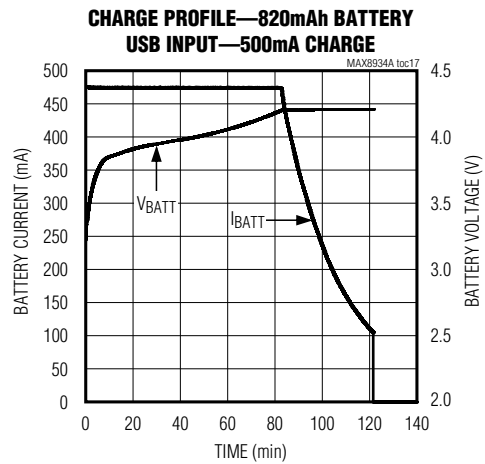
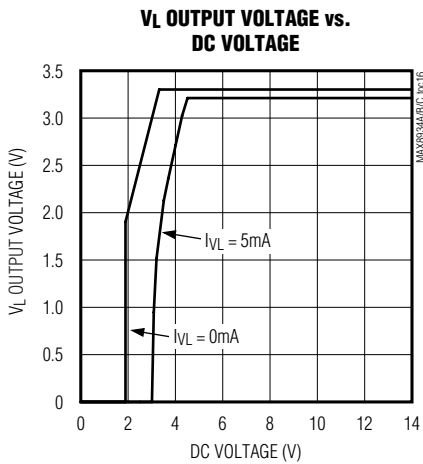
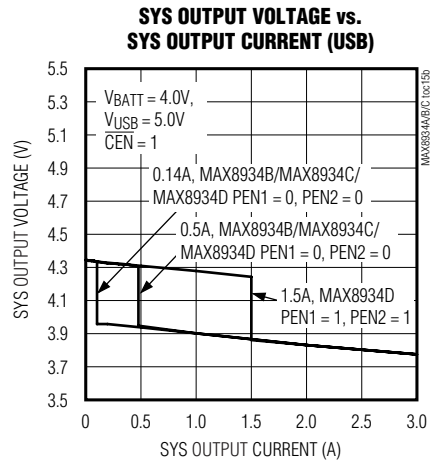
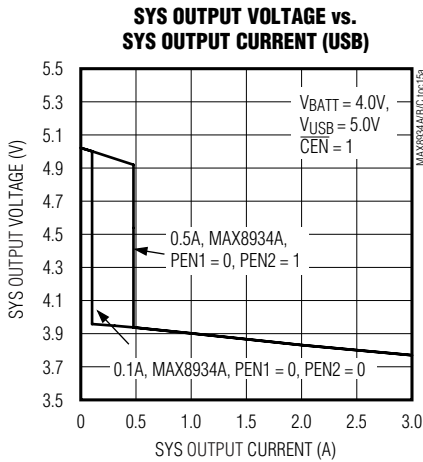

# MAX8934A-MAX8934E

## Dual-Input Linear Chargers, Smart Power Selector with Advanced Battery Temperature Monitoring

### Typical Operating Characteristics (continued)

(MAX8934A,  $T_A = +25^\circ\text{C}$ , circuit of Figure 2,  $V_{DC} = 6\text{V}$ ,  $V_{BATT} = 3.6\text{V}$ , thermistor Beta = 3964, unless otherwise noted. Negative battery current indicates charging.)

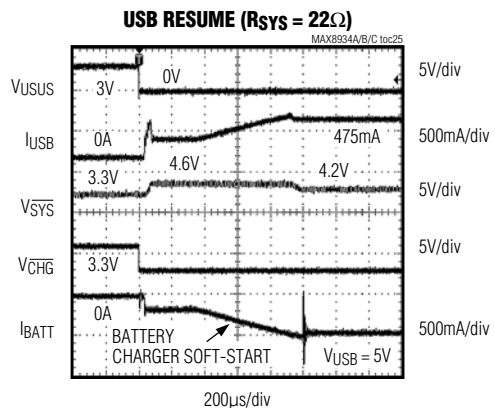
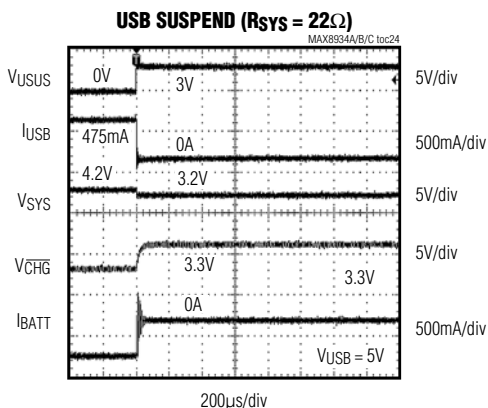
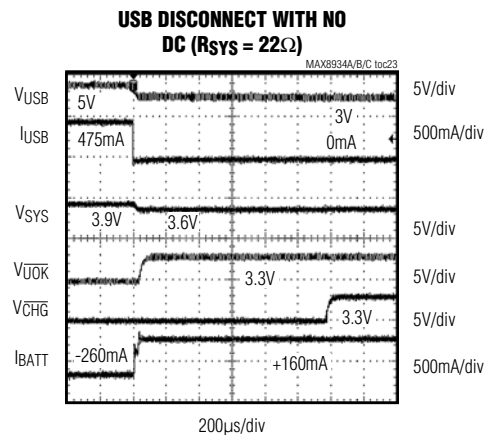
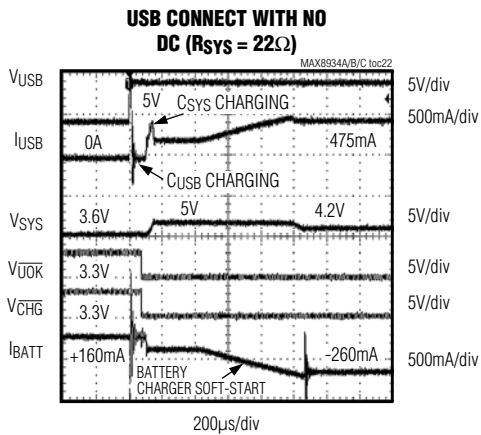
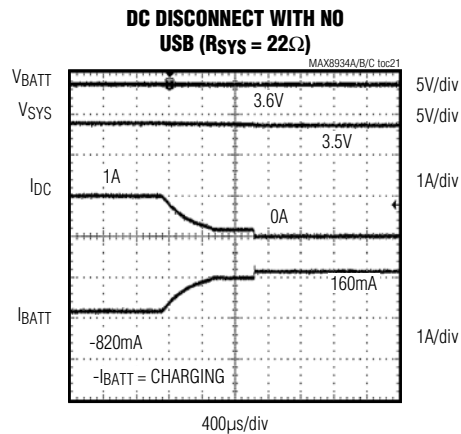
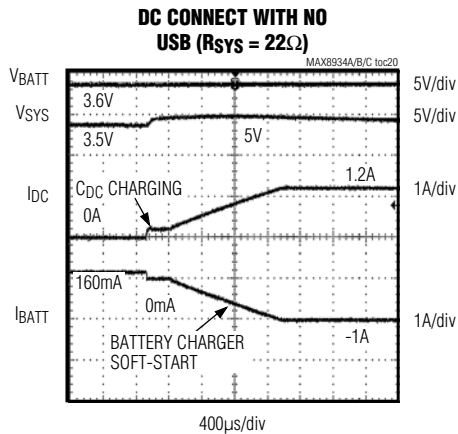

# MAX8934A-MAX8934E

## Dual-Input Linear Chargers, Smart Power Selector with Advanced Battery Temperature Monitoring

### Typical Operating Characteristics (continued)

(MAX8934A,  $T_A = +25^\circ\text{C}$ , circuit of Figure 2,  $V_{DC} = 6\text{V}$ ,  $V_{BATT} = 3.6\text{V}$ , thermistor Beta = 3964, unless otherwise noted. Negative battery current indicates charging.)

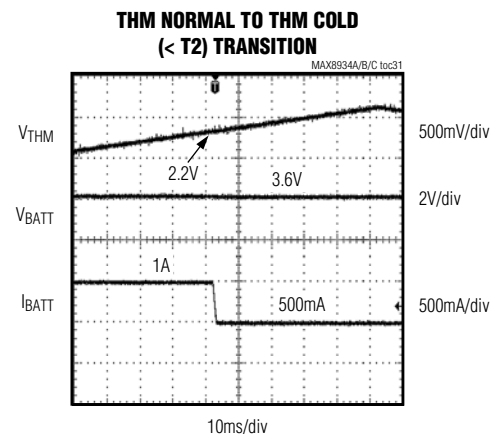
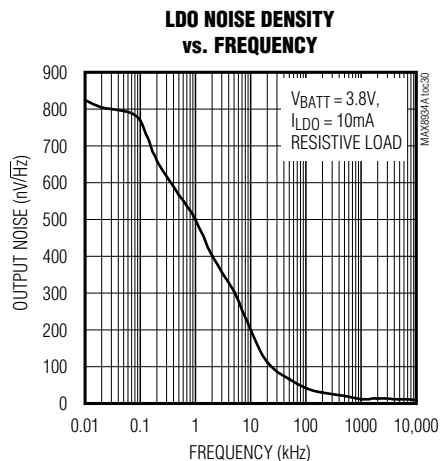
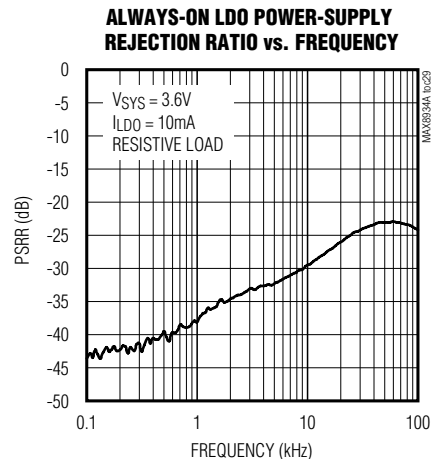
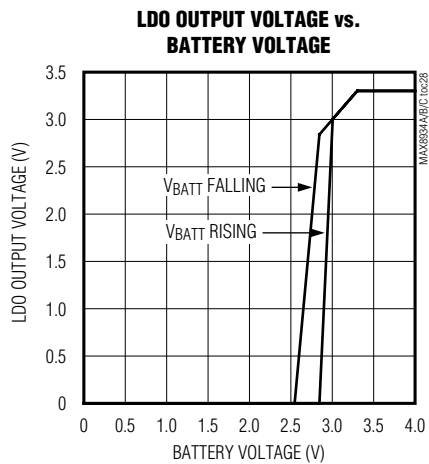
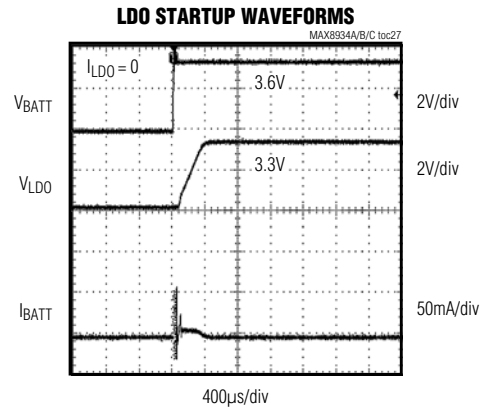
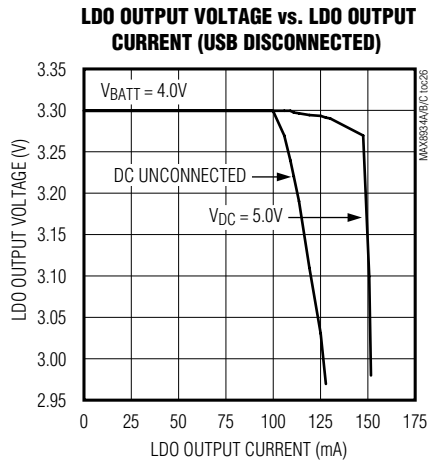

# MAX8934A-MAX8934E

## Dual-Input Linear Chargers, Smart Power Selector with Advanced Battery Temperature Monitoring

### Typical Operating Characteristics (continued)

(MAX8934A,  $T_A = +25^\circ\text{C}$ , circuit of Figure 2,  $V_{DC} = 6\text{V}$ ,  $V_{BATT} = 3.6\text{V}$ , thermistor Beta = 3964, unless otherwise noted. Negative battery current indicates charging.)

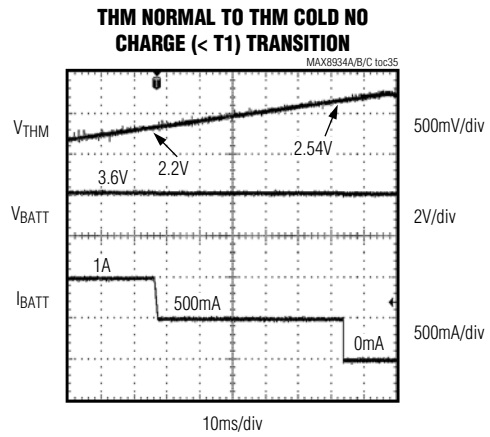
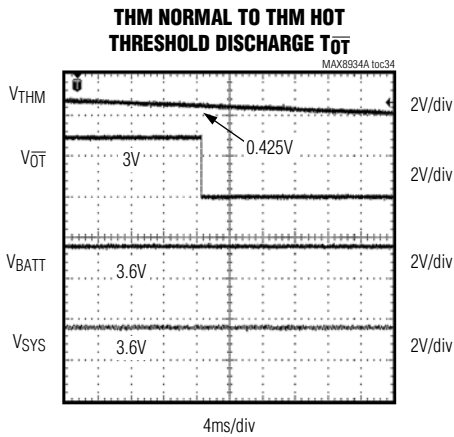
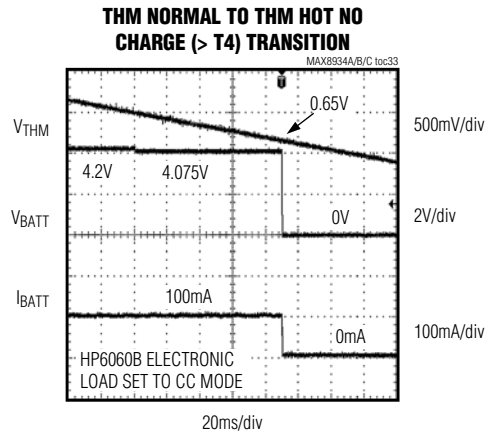
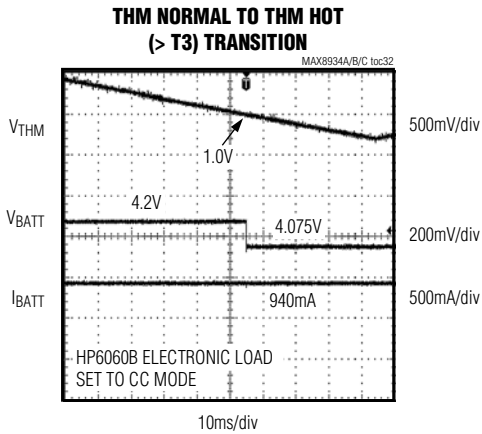

# MAX8934A–MAX8934E

## Dual-Input Linear Chargers, Smart Power Selector with Advanced Battery Temperature Monitoring

### Pin Description

PIN	NAME	FUNCTION
1	$\overline{\text{DONE}}$	Charge Complete Output. The $\overline{\text{DONE}}$ active-low, open-drain output pulls low when the charger enters the DONE state. The charger current = 0mA when $\overline{\text{DONE}}$ is low. See Figure 8.
2, 3	DC	DC Power Input. DC is capable of delivering up to 2A to SYS. DC supports both AC adapter and USB inputs. The DC current limit is set with PEN1, PEN2, and RPSET. See Table 2. Both DC pins must be connected together externally. Connect a 10 $\mu$ F ceramic capacitor from DC to GND. The DC inputs should be grounded if not used.
4	$\overline{\text{CEN}}$	Active-Low Charger Enable Input. Connect $\overline{\text{CEN}}$ to GND or drive low with a logic signal to enable battery charging when a valid source is connected at DC or USB. Drive high with a logic signal to disable battery charging.
5	PEN1	Input Limit Control 1. See Table 2a for complete information (MAX8934A/MAX8934B/MAX8934C/MAX8934E). Input Limit Control 1. See Table 2b for complete information (MAX8934D).
6	PEN2	Input Limit Control 2. See Table 2a for complete information (MAX8934A/MAX8934B/MAX8934C/MAX8934E). Input Limit Control 2. See Table 2b for complete information (MAX8934D).
7	PSET	DC Input Current-Limit Setting. Connect a resistor from PSET to GND to program the DC current limit up to 2A (3000/RPSET).
8	VL	Internal Logic LDO Output Bypass Pin. Provides 3.3V when DC or USB is present. Connect a 0.1 $\mu$ F ceramic capacitor from VL to GND. VL powers the internal circuitry and provides up to 5mA to an external load.
9, 13	GND	Ground. Both GND pins must be connected together externally.
10	CT	Charge Timer Program Input. A capacitor from CT to GND sets the maximum prequal and fast-charge timers. Connect CT to GND to disable the timer.
11	ISET	Charge Current-Limit Setting. A resistor (RISET) from ISET to GND programs the fast-charge charge current up to 1.5A (3000/RISET). The prequal charge current is 10% of the set fast-charge charge current.
12	USUS	USB Suspend Digital Input. As shown in Table 2a, driving USUS high suspends the DC or USB inputs if they are configured as a USB power input (MAX8934A/MAX8934B/MAX8934C/MAX8934E). USB Suspend Digital Input. As shown in Table 2b, driving USUS high suspends the DC or USB inputs if they are configured as a USB power input (MAX8934D).
14	THM	Thermistor Input. Connect a negative temperature coefficient (NTC) thermistor with good thermal contact with the battery from THM to GND. Use a thermistor with Beta = 3964. Connect a resistor of equal resistance to the thermistor resistance at +25°C from THM to THMSW so that the battery temperature can be monitored, and the fast-charge current and/or the charge termination voltage is automatically adjusted, in accordance with safety region 1 or safety region 2 of the JEITA specification.
15	THMEN	Thermistor Enable Input. THMEN controls THMSW by connecting the external thermistor pullup resistor and the thermistor monitoring circuit to LDO. Drive THMEN high to enable the thermistor circuit in discharge mode and to connect the external thermistor pullup resistor. Drive THMEN low to disconnect the external thermistor pullup resistor and to disable the thermistor monitoring circuit to conserve battery energy when not charging.

# MAX8934A–MAX8934E

## Dual-Input Linear Chargers, Smart Power Selector with Advanced Battery Temperature Monitoring

### Pin Description (continued)

PIN	NAME	FUNCTION
16	THMSW	Thermistor Pullup Supply Switch. Drive THMEN high to enable the THMSW, shorting the THMSW output to LDO. Drive THMEN low to open the THMSW switch. THMSW is always on when a valid input source is present and the battery is being charged. When no input source is present, THMSW is controlled by THMEN. THMSW is also active when the battery is being discharged, so that the battery temperature can be monitored for an overtemperature condition.
17	LDO	Always-On Linear Regulator Output. LDO is the output of an internal always-on 3.3V LDO that provides power to external circuitry. The LDO output provides up to 30mA of current for indicator LEDs or other loads. LDO remains active even when only a battery is present, so that the thermistor monitor circuitry can be activated when the battery is being discharged, and other circuitry can remain powered. Connect a 1µF ceramic capacitor from LDO to GND.
18, 19	USB	USB Power Input. USB is capable of delivering up to 0.5A to SYS in the MAX8934A/MAX8934B/MAX8934C/MAX8934E. The USB current limit is set with PEN2 and USUS. See Table 2a. In the MAX8934D, USB is capable of delivering up to 1.5A to SYS. Both USB pins must be connected together externally. Connect a 4.7µF ceramic capacitor from USB to GND. The USB input should be grounded if it is not used.
20, 21	BATT	Battery Connection. Connect the positive terminal of a single-cell Li+ battery to BATT. The battery charges from SYS when a valid source is present at DC or USB. BATT powers SYS when neither DC nor USB power is present, or when the SYS load exceeds the input current limit. Both BATT pins must be connected together externally.
22	$\overline{\text{CHG}}$	Charger Status Output. The $\overline{\text{CHG}}$ active-low, open-drain output pulls low when the battery is in fast charge or prequal. Otherwise, $\overline{\text{CHG}}$ is high impedance.
23, 24	SYS	System Supply Output. SYS is connected to BATT through an internal 40mΩ system load switch when DC or USB are invalid, or when the SYS load is greater than the input current limit. When a valid voltage is present at DC or USB, SYS is limited to 5.3V (MAX8934A) or 4.35V (MAX8934B/MAX8934C/MAX8934D/MAX8934E). When the system load ( $I_{\text{SYS}}$ ) exceeds the DC or USB current limit, SYS is regulated to 68mV below $V_{\text{BATT}}$ and both the input and the battery service the SYS load. Bypass SYS to GND with a 10µF ceramic capacitor. Both SYS pins must be connected together externally.
25	$\overline{\text{OT}}$	Battery Overtemperature Flag. The $\overline{\text{OT}}$ active-low, open-drain output pulls low when THMEN is high and the battery temperature is $\geq +75^{\circ}\text{C}$ .
26	$\overline{\text{DOK}}$	DC Power-OK Output. The $\overline{\text{DOK}}$ active-low, open-drain output pulls low when a valid input is detected at DC.
27	$\overline{\text{UOK}}$	USB Power-OK Output. The $\overline{\text{UOK}}$ active-low, open-drain output pulls low when a valid input is detected at USB.
28	$\overline{\text{FLT}}$	Fault Output. The $\overline{\text{FLT}}$ active-low, open-drain output pulls low when the battery timer expires before prequal or fast charge complete.
—	EP	Exposed Pad. Connect the exposed pad to GND. Connecting the exposed pad does not remove the requirement for proper ground connections to the appropriate pins.



# MAX8934A-MAX8934E

## Dual-Input Linear Chargers, Smart Power Selector with Advanced Battery Temperature Monitoring

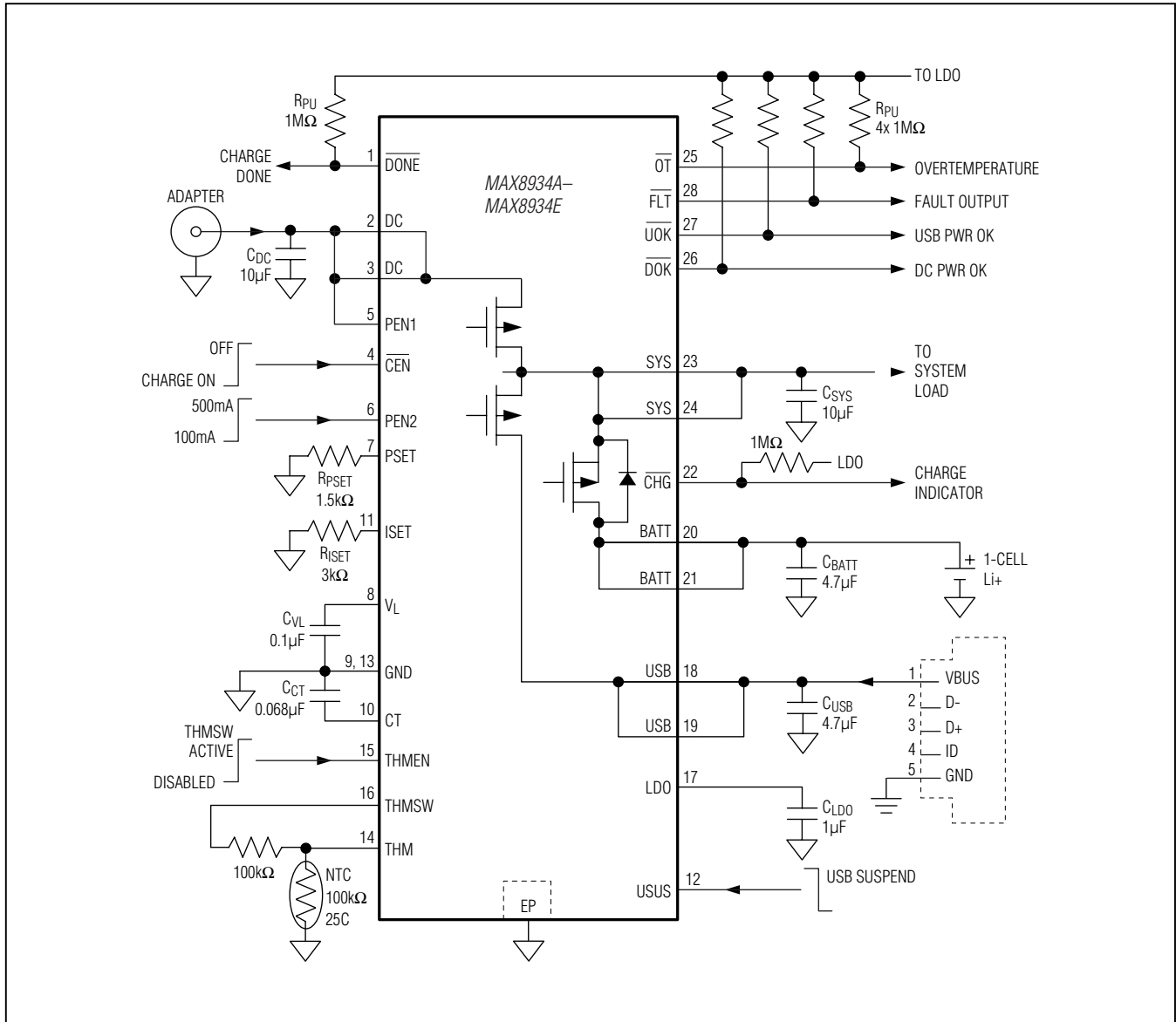

Figure 2. Typical Application Circuit Using Separate DC and USB Connector



# MAX8934A–MAX8934E

## Dual-Input Linear Chargers, Smart Power Selector with Advanced Battery Temperature Monitoring

**Table 1. External Components List for Figures 2 and 3**

COMPONENT (Figures 2 and 3)	FUNCTION	PART NUMBER
CDC	DC filter capacitor	10 $\mu$ F $\pm$ 10%, 16V X5R ceramic capacitor (0805) Taiyo Yuden EMK212BJ106KG
CVL	V <sub>L</sub> filter capacitor	0.1 $\mu$ F $\pm$ 10%, 10V X5R ceramic capacitor (0402) Taiyo Yuden LMK105BJ104KV
CSYS	SYS output bypass capacitors	10 $\mu$ F $\pm$ 10%, 6.3V X5R ceramic capacitor (0805) Taiyo Yuden JMK212BJ106KD
CBATT	Battery bypass capacitor	4.7 $\mu$ F $\pm$ 10%, 6.3V X5R ceramic capacitor (0805) Taiyo Yuden JMK212BJ475KD
CCT	Charger timing capacitor	0.068 $\mu$ F $\pm$ 10%, 16V X5R ceramic capacitor (0402) Taiyo Yuden EMK105BJ683KV
CLDO	LDO output capacitor	1 $\mu$ F $\pm$ 10%, 6.3V X5R ceramic capacitor (0402) Taiyo Yuden JMK105BJ105KV
RPU (x5)	Logic-output pullup resistors	1M $\Omega$ $\pm$ 5% resistor
THM	Negative TC thermistor	Vishay NTC Thermistor P/N NTHS0603N01N1003FF
RTHMSW	THM pullup resistor	100k $\Omega$
RPSET	DC input current-limit programming resistor	1.5k $\Omega$ $\pm$ 1% for 2A limit
R <sub>I</sub> SET	Fast-charge current programming resistor	3k $\Omega$ $\pm$ 1% for 1A charging

### Detailed Description

The MAX8934\_ is a dual-input linear charger with Smart Power Selector that safely charges a single Li+/Li-Poly cell in accordance with JEITA specifications\*. The MAX8934\_ integrates power MOSFETs and control circuitry to manage power flow in portable devices. See Figure 1. The charger has two power inputs, DC and USB. These can be separately connected to an AC adapter output and a USB port, or the DC input could be a single power input that connects to either an adapter or USB. Logic inputs, PEN1 and PEN2, select the correct current limits for two-input or single-input operation. Figure 2 is the typical application circuit using separate DC and USB connectors. Figure 3 is the typical application circuit using a 5-pin USB connector or another DC/USB common connector.

In addition to charging the battery, the MAX8934\_ also supplies power to the system through the SYS output. The charging current is also provided from SYS so that the set input current limit controls the total SYS current, where total SYS current is the sum of the system load current and the battery-charging current. SYS is powered from either the DC input pin or the USB sources

input pin. If both the DC and USB sources are connected, DC takes precedence.

In some instances, there may not be enough adapter current or USB current to supply peak system loads. The MAX8934\_ Smart Power Selector circuitry offers flexible power distribution from an AC adapter or USB source to the battery and system load. The battery is charged with any available power not used by the system load. If a system load peak exceeds the input current limit, supplemental current is taken from the battery. Thermal limiting prevents overheating by reducing power drawn from the input source.

The MAX8934\_ features an overvoltage limiter at SYS. If the DC or USB input voltage exceeds the SYS regulation voltage, V<sub>SYS</sub> does not follow V<sub>DC</sub> or V<sub>USB</sub>, but remains at its regulation voltage. The MAX8934\_ has numerous other charging and power-management features that are detailed in the following sections.

A 3.3V ultra-low quiescent current, always-on LDO provides up to 30mA for indicator LEDs and for backup power to the system. This LDO powers the thermistor monitor circuitry and provides bias to the external pullup resistor for the thermistor.

\*JEITA (Japan Electronics and Information Technology Industries Association) Standard, A Guide to the Safe Use of Secondary Lithium Ion Batteries on Notebook–Type Personal Computers, April 20, 2007.

# MAX8934A–MAX8934E

## Dual-Input Linear Chargers, Smart Power Selector with Advanced Battery Temperature Monitoring

### Smart Power Selector

The MAX8934\_ Smart Power Selector seamlessly distributes power among the external inputs, the battery, and the system load (see the *Typical Operating Circuit*). The basic functions performed are:

- With both an external power supply (USB or adapter) and battery connected:
  - When the system load requirements are less than the input current limit, the battery is charged with residual power from the input.
  - When the system load requirements exceed the input current limit, the battery supplies supplemental current to the load.
- When the battery is connected and there is no external power input, the system is powered from the battery.
- When an external power input is connected and there is no battery, the system is powered from the external power input.

A thermal-limiting circuit reduces the battery charge rate and external power-source current to prevent the MAX8934\_ from overheating.

### System Load Switch

An internal 40m $\Omega$  MOSFET connects SYS to BATT (Q3 in the *Typical Operating Circuit*) when no voltage source is available at DC or USB. When an external source is detected at DC or USB, this switch is opened and SYS is powered from the valid input source through the input limiter.

The SYS-BATT switch also holds up SYS when the system load exceeds the input current limit. If that should happen, the SYS-BATT switch turns on so that the battery supplies additional SYS load current. If the system load continuously exceeds the input current limit, the battery does not charge, even though external power is connected. This is not expected to occur in most cases, since high loads usually occur only in short peaks. During these peaks, battery energy is used, but at all other times the battery charges.

### Input Limiter

The input voltage limiter is essentially an LDO regulator. While in dropout, the regulator dissipates a small  $I^2R$  loss through the 0.2 $\Omega$  MOSFET (Q1 in the *Typical Operating Circuit*) between DC and SYS. With an AC adapter or USB source connected, the input limiter distributes power from the external power source to the system load and battery charger. In addition to the input limiter's primary function of passing power to the system

and charger loads at SYS, it performs several additional functions to optimize use of available power.

### Input Voltage Limiting

If an input voltage is above the overvoltage threshold (6.9V typ), the MAX8934\_ enters overvoltage lockout (OVLO). OVLO protects the MAX8934\_ and downstream circuitry from high-voltage stress up to 14V at DC and 8V at USB. In OVLO,  $V_L$  remains on, the input switch that sees overvoltage (Q1, Q2, *Typical Operating Circuit*) opens, and the appropriate power-monitor output ( $\overline{DOK}$ , UOK) is high impedance, and CHG is high impedance. If both DC and USB see overvoltage, both input switches (Q1 and Q2, *Typical Operating Circuit*) open and the charger turns off. The BATT-to-SYS switch (Q3, *Typical Operating Circuit*) closes, allowing the battery to power SYS. An input is also invalid if it is less than BATT, or less than the DC undervoltage threshold of 3.5V (falling). With an invalid input voltage, SYS connects to BATT through a 40m $\Omega$  switch (Q3, *Typical Operating Circuit*).

### Input Overcurrent Protection

The current at DC and USB is limited to prevent input overload. This current limit can be selected to match the capabilities of the source, whether it is a 100mA or 500mA USB source, or an AC adapter. When the load exceeds the input current limit, SYS drops to 75mV below BATT and the battery supplies supplemental load current.

### Thermal Limiting

The MAX8934\_ reduces input limiter current by 5%/°C when its die temperature exceeds +100°C. The system load (SYS) has priority over the charger current, so lowering the charge current first reduces the input current. If the junction temperature still reaches +120°C in spite of charge current reduction, no input (DC or USB) current is drawn, the battery supplies the entire system load, and SYS is regulated at 75mV below BATT. Note that this on-chip thermal-limiting circuitry is not related to and operates independently from the thermistor input.

### Adaptive Battery Charging

While the system is powered from DC, the charger draws power from SYS to charge the battery. If the charger load plus system load exceeds the input current limit, an adaptive charger control loop reduces charge current to prevent the SYS voltage from collapsing. Maintaining a higher SYS voltage improves efficiency and reduces power dissipation in the input limiter. The total current through the switch (Q1 or Q2 in the *Typical Operating Circuit*) is the sum of the load current at SYS and the battery charging current. The MAX8934A limiter clamps at 5.3V (4.35V for the MAX8934B/MAX8934C/

# MAX8934A–MAX8934E

## Dual-Input Linear Chargers, Smart Power Selector with Advanced Battery Temperature Monitoring

MAX9834D), so input voltages greater than 5.3V (4.35V for the MAX8934B/MAX8934C/MAX8934E) can increase power dissipation in the limiter. The MAX8934\_ input limiter power loss is  $(V_{DC} - V_{SYS}) \times I_{DC}$ , where  $V_{SYS}$  may be as high as 5.3V for the MAX8934A or 4.35V for the MAX8934B–MAX8934E. The input limiter power loss is not less than  $0.2\Omega \times I_{DC}^2$ . Also note that the MAX8934\_ turns off when any input exceeds 6.9V (typ).

### DC and USB Connections and Current-Limit Options

#### Input Current Limit

The input and charger current limits are set as shown in Tables 2a and 2b. It is often preferable to change the input current limit as the input power source is changed. The MAX8934\_ facilitates this by allowing different input current limits for DC and USB as shown in Tables 2a and 2b.

When the input current limit is reached, the first action taken by the MAX8934\_ is to reduce the battery charge current. This allows the regulator to stay in dropout, or at 5.3V (MAX8934A), during heavy loads, thus reducing power dissipation. If, after the charge current is reduced to 0mA, the load at SYS still exceeds the input current limit, SYS voltage begins to fall. When the SYS voltage drops to BATT, the SYS-to-BATT switch turns on, using battery power to support the system load during the load peak. The MAX8934\_ features flexible input connections (at the DC and USB input pins) and current-limit settings (set by PEN1, PEN2, PSET, and ISET) to accommodate nearly any input power configuration. However, it is expected that most systems use one of two external power schemes: separate connections for USB and an AC adapter, or a single connector that accepts either

USB or AC adapter output. Input and charger current limit are controlled by PEN1, PEN2, RPSET, and Riset, as shown in Tables 2a and 2b.

### Separate Adapter and USB Connectors

When the AC adapter and USB have separate connectors, the adapter output connects to DC and the USB source connects to USB. PEN1 is permanently connected high (to DC or  $V_L$ ). The DC current limit is set by RPSET, while the USB current limit is set by PEN2 and USUS.

### Single Common Connector for USB or Adapter

When a single common connector is used for both AC adapter and USB sources, the DC input is used for both input sources. The unused USB inputs should be grounded when an AC adapter is connected at DC, PEN1 should be pulled high to select the current limit set by RPSET. When a USB source is connected, PEN1 should be low to select 500mA, 100mA, or USB suspend (further selected by PEN2 and USUS). PEN1 can be pulled up by the AC adapter power to implement hardware adapter/USB selection.

### USB Suspend

Driving USUS high when PEN1 is low turns off charging, as well as the SYS output and reduces input current to 190µA to accommodate USB suspend mode.

### Power Monitor Outputs ( $\overline{UOK}$ , $\overline{DOK}$ )

$\overline{DOK}$  is an open-drain output that pulls low when the DC input has valid power.  $\overline{UOK}$  is an open-drain output that pulls low when the USB input has valid power. A valid input for DC or USB is between 4.1V and 6.6V. If a single power-OK output is preferred,  $\overline{DOK}$  and  $\overline{UOK}$  can be

**Table 2a. Input Limiter Control Logic (MAX8934A/MAX8934B/MAX8934C/MAX8934E)**

POWER SOURCE	$\overline{DOK}$	$\overline{UOK}$	PEN1	PEN2	USUS	DC INPUT CURRENT LIMIT	USB INPUT CURRENT LIMIT	MAXIMUM CHARGE CURRENT*
AC adapter at DC input	L	X	H	X	X	3000V/RPSET	USB input off; DC input has priority	3000V/Riset
USB power at DC input	L	X	L	H	L	475mA		475mA
	L	X	L	L	L	95mA		95mA
USB power at DC input	L	X	L	X	H	USB suspend		0
	H	L	X	H	L	No DC input	475mA	3000V/Riset
USB power at USB input; DC unconnected	H	L	X	L	L		95mA	
	DC and USB unconnected	H	L	X	X		H	USB suspend
		H	H	X	X		X	No USB input

\*Charge current cannot exceed the input current limit. Charge may be less than the maximum charge current if the total SYS load exceeds the input current limit.

# MAX8934A–MAX8934E

## Dual-Input Linear Chargers, Smart Power Selector with Advanced Battery Temperature Monitoring

Table 2b. Input Limiter Control Logic (MAX8934D)

FEATURE		DC INPUT			USB INPUT		NOTES	
Absolute Maximum Rating		16V			9V		—	
Input Current Limit		Set by RPSET, PEN1, PEN2, and USUS; 2A (max)			Set by RPSET, PEN1, PEN2, and USUS; 1.5A (max)		PSET sets the same input current limit for DC and USB paths.	
POWER SOURCE	$\overline{\text{DOK}}$	$\overline{\text{UOK}}$	PEN1	PEN2	USUS	DC INPUT CURRENT LIMIT	USB INPUT CURRENT LIMIT	MAXIMUM CHARGE CURRENT
AC Adapter at DC	L	X	H	X	X	3000V/RPSET	USB Input Off; DC input has priority	3000V/RISET
USB Power at DC	L	X	H	X	X	3000V/RPSET		3000V/RISET
	L	X	L	H	L	475mA		475mA
	L	X	L	L	L	95mA		95mA
	L	X	L	X	H	USB suspend		0
USB Power at USB; DC Open	H	L	H	H	L	No DC input	3000V/RPSET	3000V/RISET
	H	L	H	L	L		600V/RPSET	3000V/RISET
	H	L	L	H	L		475mA	475mA
	H	L	L	L	L		95mA	95mA
	H	L	X	X	H		USB suspend	0
DC and USB Open	H	H	X	X	X		No USB input	0

wire-ORed together. The combined output then pulls low if either USB or DC is valid.

### Soft-Start

To prevent input transients that can cause instability in the USB or AC adapter power source, the rate of change of input current and charge current is limited. When a valid DC or USB input is connected, the input current limit is ramped from zero to the set current-limit value (as shown in Tables 2a and 2b). If DC is connected with no USB power present, input current ramps in 1.5ms. If DC is connected with USB already present, input current ramps in 50 $\mu$ s. When USB is connected with no DC present, input current also ramps in 50 $\mu$ s. If USB is connected with DC already present, the USB input is ignored.

If an adapter is plugged into DC while USB is already powered, the input current limit reramps from zero back up to the DC current limit so that the AC adapter does not see a load step. During this transition, if the input current limit is below the SYS load current, the battery supplies the additional current needed to support the load. Additionally, capacitance can be added to SYS to

support the load during input power transitions. When the charger is turned on, charge current ramps from zero to the ISET current value in typically 1.5ms. Charge current also ramps when transitioning to fast-charge from prequal and when changing the USB charge current from 100mA to 500mA with PEN2. There is no di/dt limiting, however, if ISET is changed suddenly using a switch at RISET.

### Battery Charger

The battery charger state diagram is illustrated in Figure 8. With a valid DC or USB input, the battery charger initiates a charge cycle when the charger is enabled. It first detects the battery voltage. If the battery voltage is less than the BATT prequal threshold (3.0V), the charger enters prequal mode and charges the battery at 10% of the maximum fast-charge current. This reduced charge rate ensures that the maximum fast-charge current setting does not damage a deeply discharged battery. Once the battery voltage rises to 3.0V, the charger transitions to fast-charge mode and applies the maximum charge current. As charging continues, the battery voltage rises until it approaches the battery regulation volt-

# MAX8934A–MAX8934E

## Dual-Input Linear Chargers, Smart Power Selector with Advanced Battery Temperature Monitoring

age where charge current starts tapering down. When charge current decreases to 10% of the fast-charge current, the charger enters a brief 15s top-off, (60min for the MAX8934B and MAX8934D) and then charging stops. If the battery voltage subsequently drops below the recharge threshold, charging restarts and the timers reset.

### Charge Enable ( $\overline{CEN}$ )

When  $\overline{CEN}$  is low, the charger is on. When  $\overline{CEN}$  is high, the charger turns off.  $\overline{CEN}$  does not affect the SYS output. In many systems, there is no need for the system controller (typically a microprocessor) to disable the charger, because the MAX8934\_ Smart Power Selector circuitry independently manages charging and adapter/battery power hand-off. In these situations,  $\overline{CEN}$  can be connected to ground.

### Setting the Charge Current

ISET adjusts charge current to match the capacity of the battery. A resistor from ISET to ground sets the maximum fast-charge current:

$$I_{CHGMAX} = 2000 \times 1.5V/R_{ISET} = 3000V/R_{ISET}$$

Determine the ICHGMAX value by considering the characteristics of the battery. It is not necessary to limit the charge current based on the capabilities of the expected AC adapter/USB charging input, the system load, or thermal limitations of the PCB. The MAX8934\_ automatically adjusts the charging algorithm to accommodate these factors.

### Monitoring the Charge Current

In addition to setting the charge current, ISET can also be used to monitor the actual current charging the battery. See Figure 4. The ISET output voltage is:

$$V_{ISET} = I_{CHG} \times 1.5V/I_{CHGMAX} = I_{CHG} \times R_{ISET}/2000$$

where ICHGMAX is the set fast-charge current and ICHG is the actual battery charge current. A 1.5V output indicates the battery is being charged at the maximum set fast charge current; 0V indicates no charging. This voltage is also used by the charger control circuitry to set and monitor the battery current. Avoid adding more than 10pF capacitance directly to the ISET pin. If filtering of the charge-current monitor is necessary, add a resistor of 100k $\Omega$  or more between ISET and the filter capacitor to preserve charger stability.

Note that the actual charge current can be less than the set fast-charge current when the charger enters voltage mode or when the input current limiter or thermal limiter

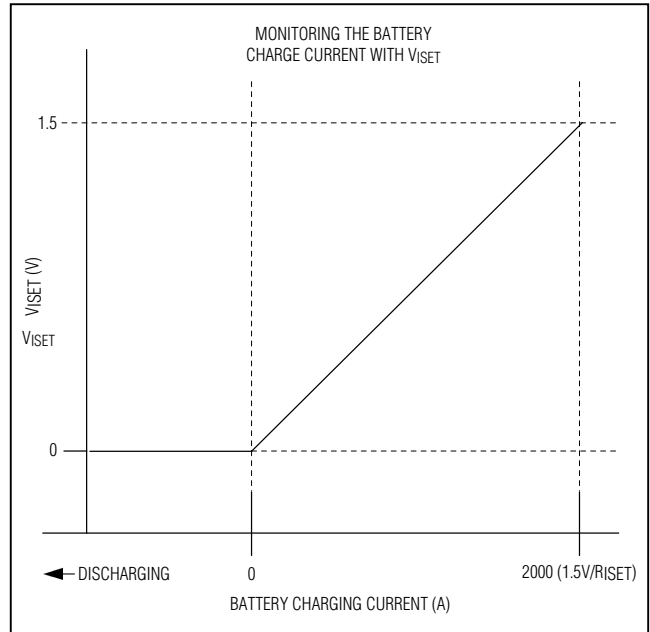

Figure 4. Monitoring the Battery Charge Current with  $V_{ISET}$

reduces charge current. This prevents the charger from overloading the input source or overheating the system.

### Charge Termination

When the charge current falls to the termination threshold and the charger is in voltage mode, charging is complete. Charging continues for a brief 15s top-off period (60min for the MAX8934B and MAX8934D) and then enters the DONE state where charging stops. The DONE current threshold ( $I_{DONE}$ ) is set to 10% of the fast-charge current setting. Note that if charge current falls to  $I_{DONE}$  as a result of the input or thermal limiter, the charger does not enter the DONE state. For the charger to enter the DONE state, the charge current must be less than  $I_{TERM}$ , the charger must be in voltage mode, and the input or thermal limiter must not be reducing the charge current. The charger exits the DONE state, and fast-charge resumes if the battery voltage subsequently drops 104mV or if  $\overline{CEN}$  is cycled.

### Charge Status Outputs

#### Charge Output ( $\overline{CHG}$ )

$\overline{CHG}$  is an open-drain, active-low output that is low during charging.  $\overline{CHG}$  is low when the battery charger is in its prequalification and fast-charge states. When charge current falls to the charge termination threshold and the charger is in voltage mode,  $\overline{CHG}$  goes high impedance.  $\overline{CHG}$  goes high impedance if the thermistor causes the charger to enter temperature suspend mode.

# MAX8934A–MAX8934E

## Dual-Input Linear Chargers, Smart Power Selector with Advanced Battery Temperature Monitoring

When the MAX8934\_ is used with a microprocessor ( $\mu\text{P}$ ), connect a pullup resistor between  $\overline{\text{CHG}}$  and the logic I/O voltage to indicate charge status to the  $\mu\text{P}$ . Alternatively,  $\overline{\text{CHG}}$  can sink up to 20mA for an LED indicator.

### Charge DONE Output ( $\overline{\text{DONE}}$ )

$\overline{\text{DONE}}$  is an open-drain, active-low output that goes low when charging is complete. The charger enters its DONE state 15s (60min for the MAX8934B and MAX8934D) after the charge current falls to the charge-termination threshold and the charger is in voltage mode. The charger exits the DONE state, and fast-charge resumes, if the battery voltage subsequently drops 104mV, or if input power or  $\overline{\text{CEN}}$  is cycled. When the MAX8934\_ is used in conjunction with a  $\mu\text{P}$ , connect a pullup resistor between  $\overline{\text{DONE}}$  and the logic I/O voltage to indicate charge status to the  $\mu\text{P}$ . Alternatively,  $\overline{\text{DONE}}$  can sink up to 20mA for an LED indicator.

### Fault Output ( $\overline{\text{FLT}}$ ) and Charge Timer

$\overline{\text{FLT}}$  is an open-drain, active-low output that goes low during a battery fault. The fault state occurs when either the prequal or fast-charge timer expires. The prequal and fast-charge fault timers are set by  $C_{\text{CT}}$ :

$$\text{PREQUAL: } t_{\text{PQ}} = 30\text{min} \times \frac{C_{\text{CT}}}{0.068\mu\text{F}}$$

$$\text{FAST CHARGE: } t_{\text{FC}} = 300\text{min} \times \frac{C_{\text{CT}}}{0.068\mu\text{F}}$$

$$\text{TOP-OFF: } t_{\text{TO}} = 15\text{s (60 minutes for the MAX8934B and MAX8934D)}$$

While in fast-charge mode, a large system load or device self-heating can cause the MAX8934\_ to reduce charge current. Under these circumstances, the fast-charge timer adjusts to ensure that adequate charge time is still allowed. Consequently, the fast-charge timer is slowed by 2x if charge current is reduced below 50% of the programmed fast-charge level. If charge current is reduced to below 20% of the programmed level, the fast-charge timer is paused. The fast-charge timer is not adjusted if the charger is in voltage mode where charge current reduces due to current tapering under normal charging.

To exit a fault state, toggle  $\overline{\text{CEN}}$  or remove and reconnect the input source(s). Note also that thermistor out of range or on-chip thermal-limit conditions are not considered faults. When the MAX8934\_ is used in conjunction with a  $\mu\text{P}$ , connect a pullup resistor between  $\overline{\text{FLT}}$  and the logic I/O voltage to indicate fault status to the  $\mu\text{P}$ . Alternatively,  $\overline{\text{FLT}}$  can sink up to 20mA for an LED indicator.

### Thermistor Monitor

The MAX8934\_ thermistor monitor is configured to execute JEITA recommendations regarding Li+/Li-Poly battery charging by adjusting the fast charge current and/or the charge termination voltage accordingly (see Figures 6 and 7). Connect the THM input to an external negative temperature coefficient (NTC) thermistor to monitor battery or system temperature. Since the thermistor monitoring circuit employs an external bias resistor from THM to THMSW, the thermistor is not limited only to 10k $\Omega$  (at +25°C). Any thermistor resistance can be used as long as the value of  $R_{\text{THMSW}}$  is equivalent to the thermistor's +25°C resistance. The MAX8934\_ THM thresholds are optimized for a thermistor Beta of 3964 or 3477 (see the *Selector Guide*). The general relation of thermistor resistance to temperature is defined by the following equation:

$$R_T = R_{25} \times e^{\left\{ \beta \left( \frac{1}{T+273^\circ\text{C}} - \frac{1}{298^\circ\text{C}} \right) \right\}}$$

where:

$R_T$  = The resistance in ohms of the thermistor at temperature T in Celsius

$R_{25}$  = The resistance in ohms of the thermistor at +25°C

$\beta$  = The material constant of the thermistor

T = The temperature of the thermistor in °C

Charging is suspended when the thermistor temperature is out of range ( $V_{\text{THM}_T1} > V_{\text{THM}} > V_{\text{THM}_T4}$ ). The charge timers are also suspended and hold their state but no fault is indicated. When the thermistor comes back into range, charging resumes and the charge timer continues from where it left off.

The THMEN input controls THMSW and the thermistor monitor circuitry when the battery charger is disabled, providing the user with the means to minimize the battery current drain caused by the thermistor monitor. The THMEN input is ignored while the battery is charging, since the thermistor must be monitored at all times.

While charging, the thermistor monitor is used to automatically adjust the charge termination voltage and/or the fast-charge current, depending on the sensed battery temperature and the safety region set at the factory. While discharging, if the battery temperature exceeds the THM hot overtemperature threshold and THMEN is high, the  $\overline{\text{OT}}$  flag pulls low. Typical systems connect  $\overline{\text{OT}}$  to a  $\mu\text{P}$  input so that the system can safely shut down.

# MAX8934A-MAX8934E

## Dual-Input Linear Chargers, Smart Power Selector with Advanced Battery Temperature Monitoring

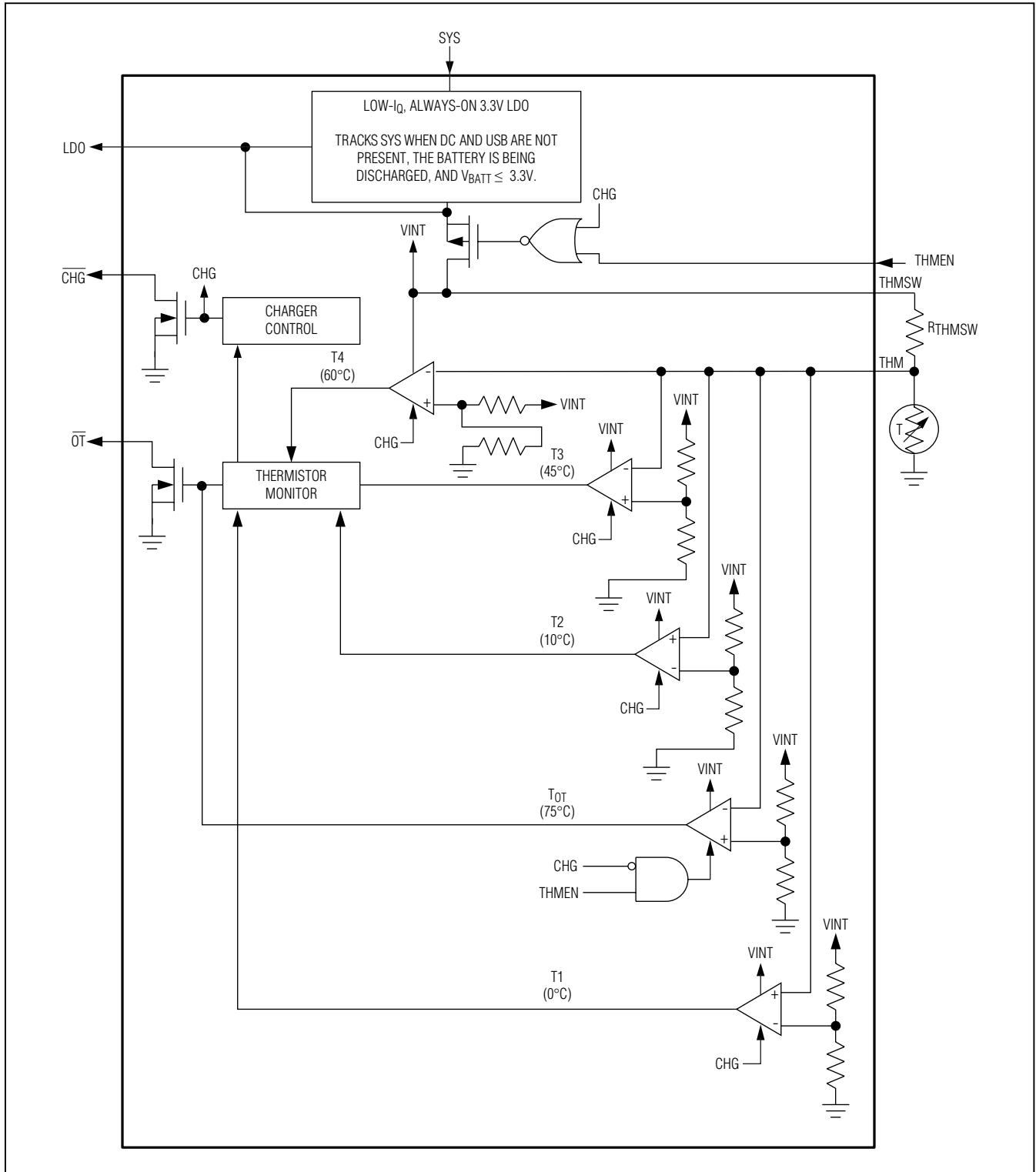

Figure 5. Thermistor Monitor Details

# MAX8934A-MAX8934E

## Dual-Input Linear Chargers, Smart Power Selector with Advanced Battery Temperature Monitoring

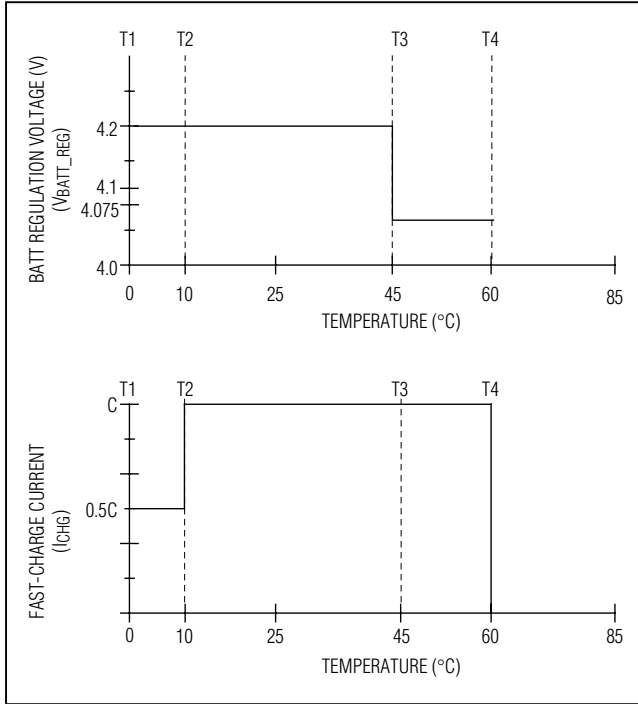

Figure 6. Safety Region 1: Fast-Charge Currents and Charge Termination Voltages

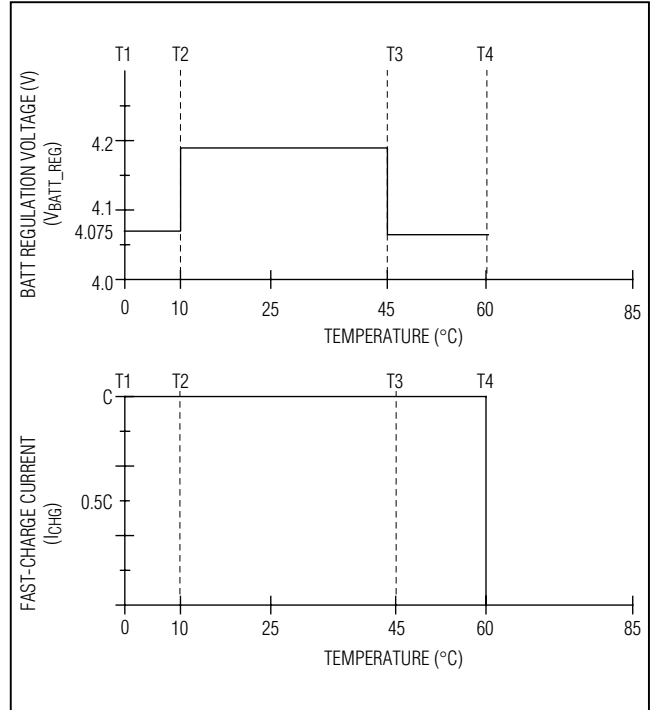

Figure 7. Safety Region 2: Fast-Charge Currents and Charge Termination Voltages

# MAX8934A–MAX8934E

## Dual-Input Linear Chargers, Smart Power Selector with Advanced Battery Temperature Monitoring

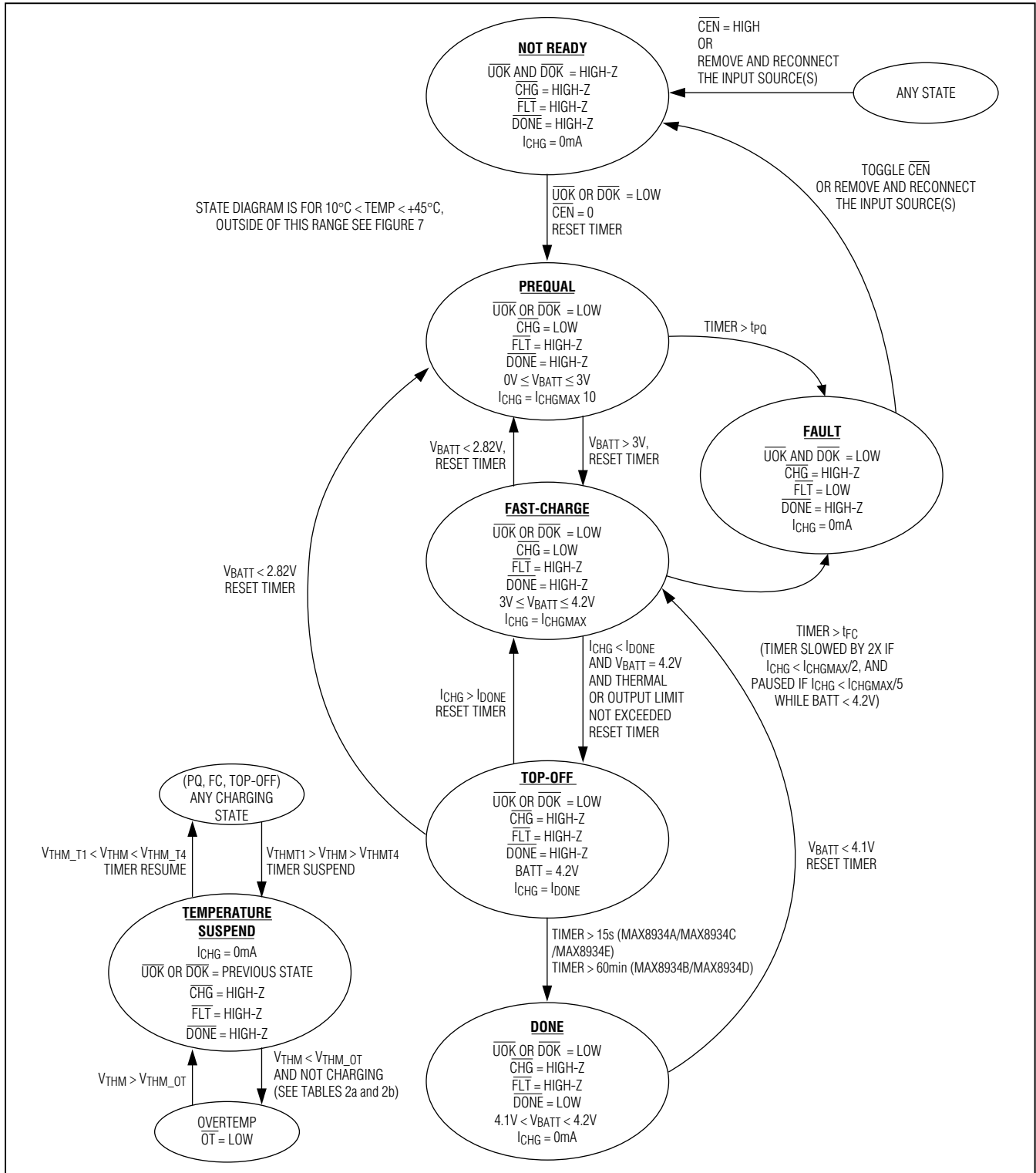

Figure 8. Charger State Diagram

# MAX8934A–MAX8934E

## Dual-Input Linear Chargers, Smart Power Selector with Advanced Battery Temperature Monitoring

### Always-On LDO

The ultra-low quiescent current LDO is always on and is preset to an output voltage of 3.3V. The LDO provides up to 30mA output current. When DC and USB are invalid and the battery is discharging, the LDO output voltage tracks  $V_{SYS}$  as it drops below 3.3V. A 1 $\mu$ F ceramic capacitor connected from LDO to GND is recommended for most applications.

**Table 3. Package Thermal Characteristics**

	28-PIN 4mm x 4mm THIN QFN	
	SINGLE-LAYER PCB	MULTILAYER PCB
Continuous Power Dissipation	1666.7mW (derate 20.8mW/°C above +70°C)	2286mW (derate 28.6mW/°C above +70°C)
$\theta_{JA}$	48°C/W	35°C/W
$\theta_{JC}$	3°C/W	3°C/W

### Pin Configuration

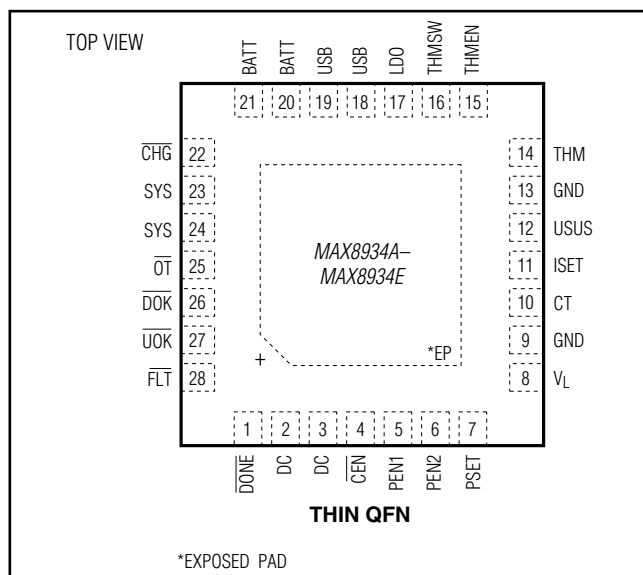

### PCB Layout and Routing

Good design minimizes ground bounce and voltage gradients in the ground plane. GND should connect to the power-ground plane at only one point to minimize the effects of power-ground currents. Battery ground should connect directly to the power-ground plane. Connect GND to the exposed pad directly under the IC. Use multiple tightly spaced vias to the ground plane under the exposed pad to help cool the IC. Position input capacitors from DC, SYS, BATT, and USB to the power-ground plane as close as possible to the IC. Keep high current traces such as those to DC, SYS, and BATT as short and wide as possible. Refer to the MAX8934 Evaluation Kit for a suitable PCB layout example.

### Chip Information

PROCESS: BiCMOS

### Ordering Information

PART	TEMP RANGE	PIN-PACKAGE
MAX8934BETI+	-40°C to +85°C	28 Thin QFN-EP*
MAX8934CETI+	-40°C to +85°C	28 Thin QFN-EP*
MAX8934DET+	-40°C to +85°C	28 Thin QFN-EP*
MAX8934EET+	-40°C to +85°C	28 Thin QFN-EP*

+Denotes a lead(Pb)-free/RoHS-compliant package.

\*EP = Exposed pad.

### Selector Guide

PART	SAFETY REGION**	SYS VOLTAGE (V)	THERMISTOR BETA†	TOP-OFF TIMER	USB INPUT CURRENT LIMIT (max)
MAX8934AETI+	1	5.3	3964	15s	500mA
MAX8934BETI+	1	4.35	3477	60min	500mA
MAX8934CETI+	1	4.35	3964	15s	500mA
MAX8934DET+	1	4.35	3477	60min	1.5A
MAX8934EET+	1	4.35	3477	15s	500mA

\*\*For safety region 2, contact factory.

†For thermistor Beta = 3477, contact factory.

# MAX8934A-MAX8934E

## Dual-Input Linear Chargers, Smart Power Selector with Advanced Battery Temperature Monitoring

### Package Information

For the latest package outline information and land patterns, go to [www.maximintegrated.com/packages](http://www.maximintegrated.com/packages). Note that a "+", "#", or "-" in the package code indicates RoHS status only. Package drawings may show a different suffix character, but the drawing pertains to the package regardless of RoHS status.

PACKAGE TYPE	PACKAGE CODE	OUTLINE NO.	LAND PATTERN NO.
28 TQFN-EP	T2844+1	<a href="#">21-0139</a>	<a href="#">90-0035</a>

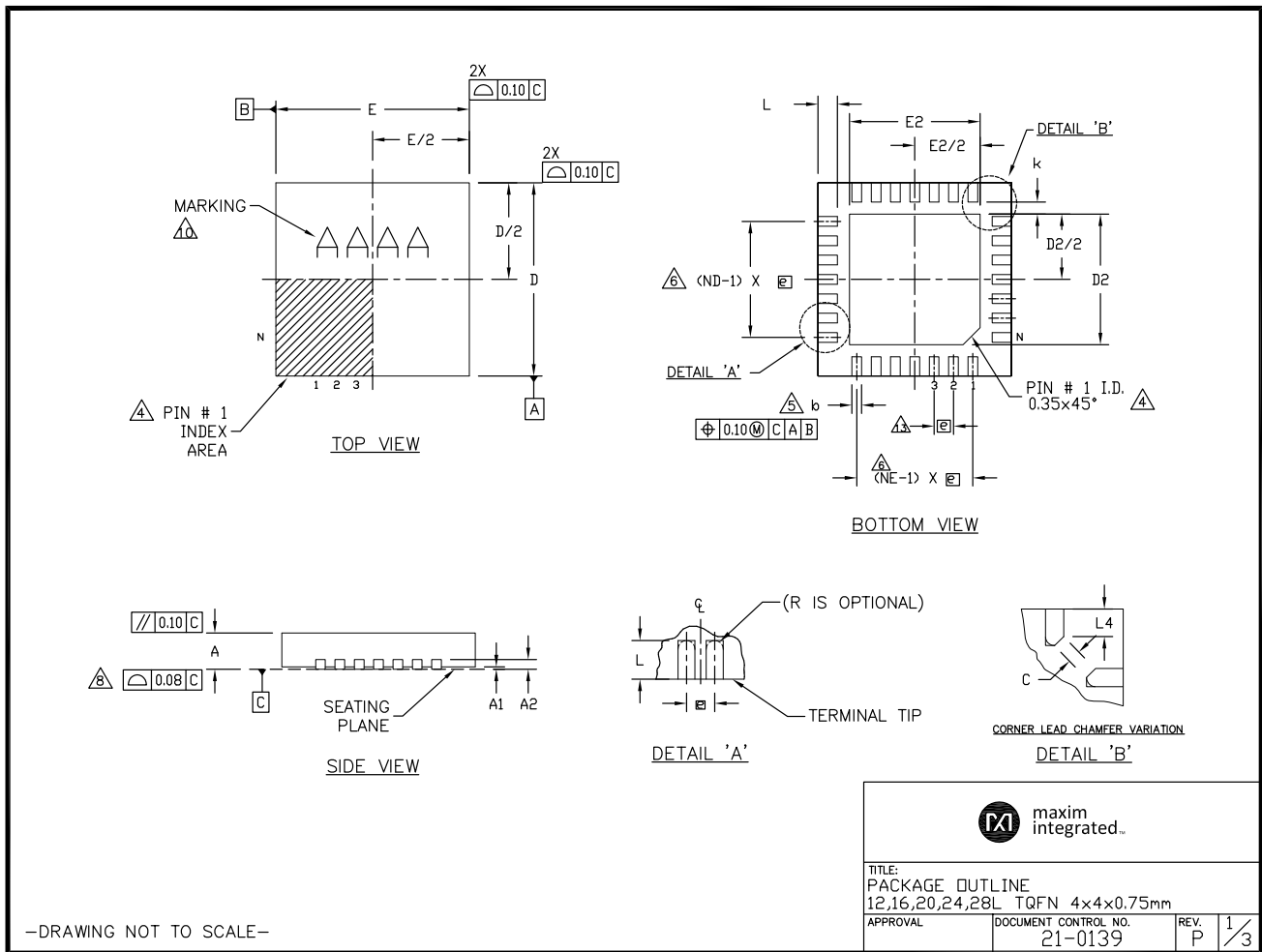

# MAX8934A–MAX8934E

## Dual-Input Linear Chargers, Smart Power Selector with Advanced Battery Temperature Monitoring

### Package Information (continued)

For the latest package outline information and land patterns, go to [www.maximintegrated.com/packages](http://www.maximintegrated.com/packages). Note that a "+", "#", or "-" in the package code indicates RoHS status only. Package drawings may show a different suffix character, but the drawing pertains to the package regardless of RoHS status.

COMMON DIMENSIONS															
PKG REF.	12L 4x4			16L 4x4			20L 4x4			24L 4x4			28L 4x4		
	MIN.	NDM.	MAX.	MIN.	NDM.	MAX.	MIN.	NDM.	MAX.	MIN.	NDM.	MAX.	MIN.	NDM.	MAX.
A	0.70	0.75	0.80	0.70	0.75	0.80	0.70	0.75	0.80	0.70	0.75	0.80	0.70	0.75	0.80
A1	0.0	0.02	0.05	0.0	0.02	0.05	0.0	0.02	0.05	0.0	0.02	0.05	0.0	0.02	0.05
A2	0.20 REF			0.20 REF			0.20 REF			0.20 REF			0.20 REF		
b	0.25	0.30	0.35	0.25	0.30	0.35	0.20	0.25	0.30	0.18	0.23	0.30	0.15	0.20	0.25
D	3.90	4.00	4.10	3.90	4.00	4.10	3.90	4.00	4.10	3.90	4.00	4.10	3.90	4.00	4.10
E	3.90	4.00	4.10	3.90	4.00	4.10	3.90	4.00	4.10	3.90	4.00	4.10	3.90	4.00	4.10
e	0.80 BSC.			0.65 BSC.			0.50 BSC.			0.50 BSC.			0.40 BSC.		
k	0.25	-	-	0.25	-	-	0.25	-	-	0.25	-	-	0.25	-	-
L	0.45	0.55	0.65	0.45	0.55	0.65	0.45	0.55	0.65	0.30	0.40	0.50	0.30	0.40	0.50
N	12			16			20			24			28		
ND	3			4			5			6			7		
NE	3			4			5			6			7		
Jedec Var.	WGGB			WGGC			WGGD-1			WGGD-2			WGGE		

DIMENSION VARIATIONS										
PKG. CODE	D2			E2			L			R <sub>LEAD TIP RADIUS</sub>
	MIN.	NDM.	MAX.	MIN.	NDM.	MAX.	MIN.	NDM.	MAX.	
T2044-4	2.85	2.90	2.95	2.85	2.90	2.95	0.25	0.30	0.35	0.125 REF
T2044-4C	2.85	2.90	2.95	2.85	2.90	2.95	0.25	0.30	0.35	0.125 REF
T2044-5	2.60	2.70	2.80	2.60	2.70	2.80	0.35	0.40	0.45	0.203 REF

  

EXPOSED PAD VARIATIONS					
PKG. CODES	D2			E2	
	MIN.	NDM.	MAX.	MIN.	MAX.
T1244-3	1.95	2.10	2.25	1.95	2.10
T1244-4	1.95	2.10	2.25	1.95	2.10
T1644-3	1.95	2.10	2.25	1.95	2.10
T1644-4	1.95	2.10	2.25	1.95	2.10
T1644-4C	1.95	2.10	2.25	1.95	2.10
T2044-2	1.95	2.10	2.25	1.95	2.10
T2044-3	1.95	2.10	2.25	1.95	2.10
T2444-2	1.95	2.10	2.25	1.95	2.10
T2444-3	2.45	2.60	2.63	2.45	2.60
T2444-3C	2.45	2.60	2.63	2.45	2.60
T2444-4	2.45	2.60	2.63	2.45	2.60
T2444-4C	2.45	2.60	2.63	2.45	2.60
T2444N-4	2.45	2.60	2.63	2.45	2.60
T2444M-1	2.45	2.60	2.63	2.45	2.60
T2444MK-1	2.45	2.60	2.63	2.45	2.60
T2844-1	2.50	2.60	2.70	2.50	2.60
T2844-1C	2.50	2.60	2.70	2.50	2.60
T2844N-1	2.65	2.70	2.75	2.65	2.70

CORNER LEAD CHAMFER VARIATION			
PKG. CODES	C		L4
T2444-2	0.120 X 45° REF		0.31 REF
T2444-3	0.120 X 45° REF		0.31 REF
T2444-3C	0.120 X 45° REF		0.31 REF
T2444-4	0.120 X 45° REF		0.31 REF
T2444-4C	0.120 X 45° REF		0.31 REF
T2444M-1	0.120 X 45° REF		0.31 REF
T2444MK-1	0.120 X 45° REF		0.31 REF
T2444N-4	0.120 X 45° REF		0.31 REF



TITLE: PACKAGE OUTLINE 12,16,20,24,28L TQFN 4x4x0.75mm			
APPROVAL	DOCUMENT CONTROL NO. 21-0139	REV. P	2/3

–DRAWING NOT TO SCALE–

# MAX8934A-MAX8934E

## Dual-Input Linear Chargers, Smart Power Selector with Advanced Battery Temperature Monitoring

### Package Information (continued)

For the latest package outline information and land patterns, go to [www.maximintegrated.com/packages](http://www.maximintegrated.com/packages). Note that a "+", "#", or "-" in the package code indicates RoHS status only. Package drawings may show a different suffix character, but the drawing pertains to the package regardless of RoHS status.

#### NOTES:

1. DIMENSIONING & TOLERANCING CONFORM TO ASME Y14.5M-1994.
2. ALL DIMENSIONS ARE IN MILLIMETERS. ANGLES ARE IN DEGREES.
3. N IS THE TOTAL NUMBER OF TERMINALS.
- △ THE TERMINAL #1 IDENTIFIER AND TERMINAL NUMBERING CONVENTION SHALL CONFORM TO JEDEC 95-1 SPP-012. DETAILS OF TERMINAL #1 IDENTIFIER ARE OPTIONAL, BUT MUST BE LOCATED WITHIN THE ZONE INDICATED. THE TERMINAL #1 IDENTIFIER MAY BE EITHER A MOLD OR MARKED FEATURE.
- △ DIMENSION  $b_1$  APPLIES TO METALLIZED TERMINAL AND IS MEASURED BETWEEN 0.25mm AND 0.30mm FROM TERMINAL TIP.
- △ ND AND NE REFER TO THE NUMBER OF TERMINALS ON EACH D AND E SIDE RESPECTIVELY.
7. DEPOPULATION IS POSSIBLE IN A SYMMETRICAL FASHION.
- △ COPLANARITY APPLIES TO THE EXPOSED HEAT SINK SLUG AS WELL AS THE TERMINALS.
9. DRAWING CONFORMS TO JEDEC MO220, EXCEPT FOR T2444-3, T2444-4 AND T2844-1.
- △ MARKING IS FOR PACKAGE ORIENTATION REFERENCE ONLY.
11. COPLANARITY SHALL NOT EXCEED 0.08mm.
12. WARPAGE SHALL NOT EXCEED 0.10mm.
- △ LEAD CENTERLINES TO BE AT TRUE POSITION AS DEFINED BY BASIC DIMENSION 'e', ±0.05.
14. NUMBER OF LEADS SHOWN ARE FOR REFERENCE ONLY.
15. MATERIAL MUST COMPLY WITH BANNED AND RESTRICTED SUBSTANCES SPEC # 10-0131.
16. ALL DIMENSIONS ARE THE SAME FOR LEADED (-) & PbFREE (+) PACKAGE CODES.

-DRAWING NOT TO SCALE-



TITLE:  
PACKAGE OUTLINE  
12,16,20,24,28L TQFN 4x4x0.75mm

APPROVAL	DOCUMENT CONTROL NO. 21-0139	REV. P	3/3
----------	---------------------------------	-----------	-----

# MAX8934A–MAX8934E

## Dual-Input Linear Chargers, Smart Power Selector with Advanced Battery Temperature Monitoring

### Revision History

REVISION NUMBER	REVISION DATE	DESCRIPTION	DATE	PAGES CHANGED
0	2/10	Initial release		—
1	3/10	Added lead temperature and tightened BATT regulation voltage specs		2, 4
2	6/10	Tightened BATT Charge Current Accuracy specification		5
3	1/14	Updated THM Threshold parameter, TOC 34, USB pin function description, <i>Thermistor Monitor</i> section, Figure 5, and Figure 8		7, 13, 15, 24, 25, 27



Maxim Integrated cannot assume responsibility for use of any circuitry other than circuitry entirely embodied in a Maxim Integrated product. No circuit patent licenses are implied. Maxim Integrated reserves the right to change the circuitry and specifications without notice at any time. The parametric values (min and max limits) shown in the Electrical Characteristics table are guaranteed. Other parametric values quoted in this data sheet are provided for guidance.

## Looking for pricing, stock, or lifecycle information?

Click below to explore more details on WIN SOURCE:

- ⊖ [View MAX8934CETI+T on WIN SOURCE](#)
- ⊖ [Maxim Integrated Information](#)

## Optimize Your Supply Chain with WIN SOURCE Solutions

- ✓ Global Sourcing Solution
- ✓ Obsolete Management
- ✓ Cost Control Management
- ✓ Shortage Management
- ✓ Alternative Solution
- ✓ Excess Inventory Management