



**THE DATASHEET OF  
MB1505**



NOT RECOMMENDED FOR NEW DESIGN, USE  
GBPC15 SERIES, GBPC25 SERIES, OR GBPC35 SERIES

### Features

- High Conductivity
- Metal Case
- Superior Thermal Design
- Terminals Solderable per MIL-STD-202, Method 208
- Universal Terminals; Snap-on, Solder or P.C. Board Mounting
- **Lead Free Finish, RoHS Compliant (Date Code 0514+)**  
(Note 2)

### Mechanical Data

- Terminals: 0.25" Faston Terminals
- Case material - UL Flammability Rating Classification 94V-0
- Moisture sensitivity: Level 1 per J-STD-020C
- Approx Weight: 29 grams
- Mounting Position: Bolt Down on Heat-sink with Silicone Thermal Compound Between Bridge and Mounting Surface for Maximum Heat Transfer Efficiency
- Mounting Torque: 20 in. lb. Max.
- Polarity: Polarity Symbols Marked on Case

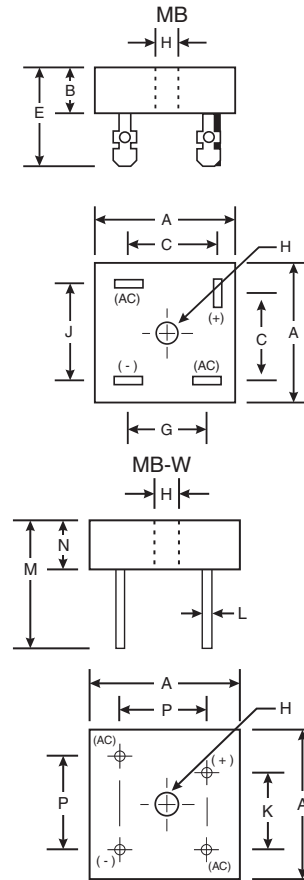

Dim	Min	Max
A	28.40	28.70
B	10.97	11.23
C	15.50	17.60
E	22.86	25.40
G	13.30	15.30
H	Hole for #10 screw	
	4.85Ø	5.59Ø
J	17.10	19.10
K	10.40	12.40
L	0.97Ø Nominal	1.07Ø
M	30.50	—
N	10.97	11.23
P	17.10	19.10

### Maximum Ratings and Electrical Characteristics

Rating at 25°C ambient temperature unless otherwise specified.

Suffix "W" denotes wire leads

Characteristic	Symbol	-05	-1	-2	-4	-6	-8	-10	Units
Maximum Recurrent Peak Reverse Voltage	$V_{RRM}$	50	100	200	400	600	800	1000	V
Maximum RMS Voltage	$V_{RMS}$	35	70	140	280	420	560	700	V
Maximum DC Blocking Voltage	$V_{DC}$	50	100	200	400	600	800	1000	V
Maximum Average Rectified Output Current @ $T_C = 55^\circ\text{C}$	MB15 MB25 MB35 $I_{(AV)}$				15.0 25.0 35.0				A
Peak Forward Surge Current Single Half Sine-Wave Superimposed on Rated Load	MB15 MB25 MB35 $I_{FSM}$				300 300 400				A
Maximum Instantaneous @ 7.5A Forward Voltage Drop per @ 12.5A Rated Load @ 17.5A	MB15 MB25 MB35 $V_F$				1.1 1.1 1.2				V
Maximum Reverse DC current at Rated DC Blocking Voltage (per Element) @ $T_A = 25^\circ\text{C}$ @ $T_A = 100^\circ\text{C}$	$I_R$				10 1.0				$\mu\text{A}$ mA
$I^2t$ rating for fusing (8.3ms)	MB15 MB25 MB35 $I^2t$				373 373 664				$\text{A}^2\text{s}$
Typical Thermal Resistance (Note 1)	$R_{\theta JC}$				2.5				$^\circ\text{C}/\text{W}$
Operating and Storage Temperature Range	$T_J, T_{STG}$				-55 to +150				$^\circ\text{C}$

Notes: 1. Thermal Resistance from junction to case

2. EC Directive 2002/95/EC (RoHS) revision 13.2.2003. Glass and High Temperature Solder Exemptions Applied, see *EU Directive Annex Notes 5 and 7.*

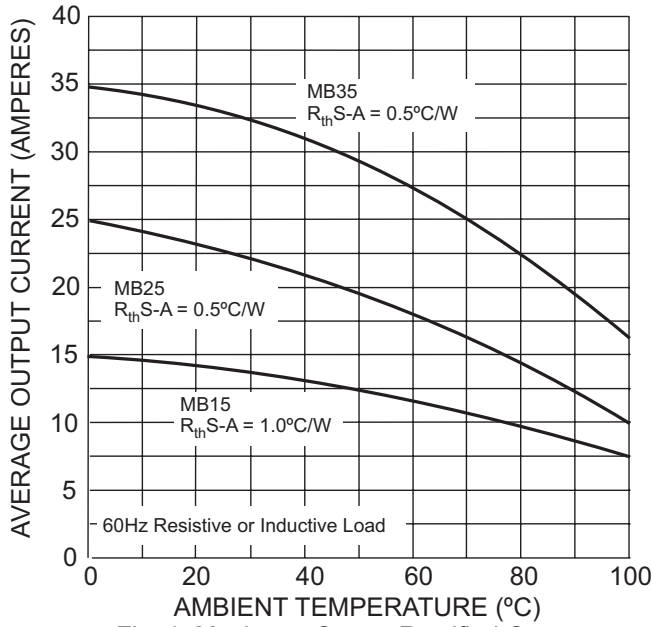

Fig. 1 Maximum Output Rectified Current

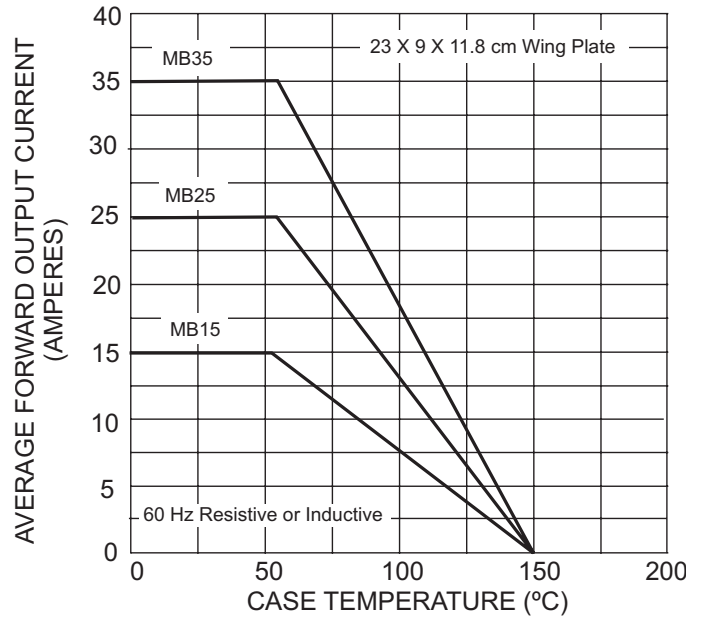

Fig. 2 Maximum Output Rectified Current

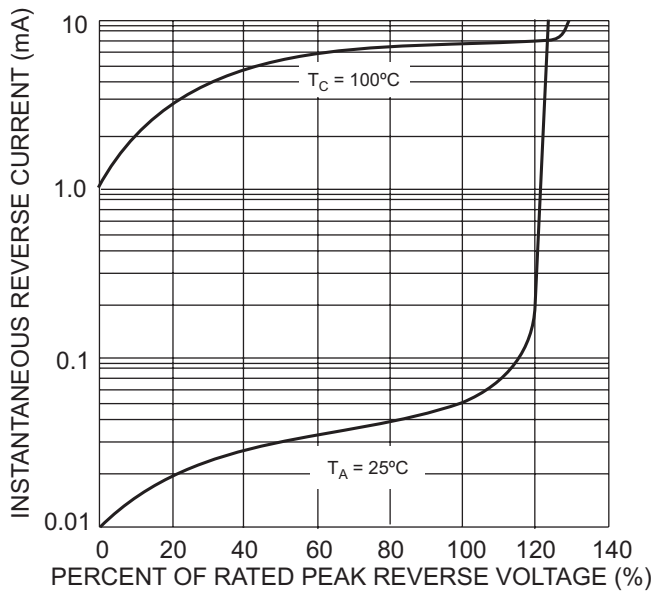

Fig. 3 Typical Reverse Characteristics

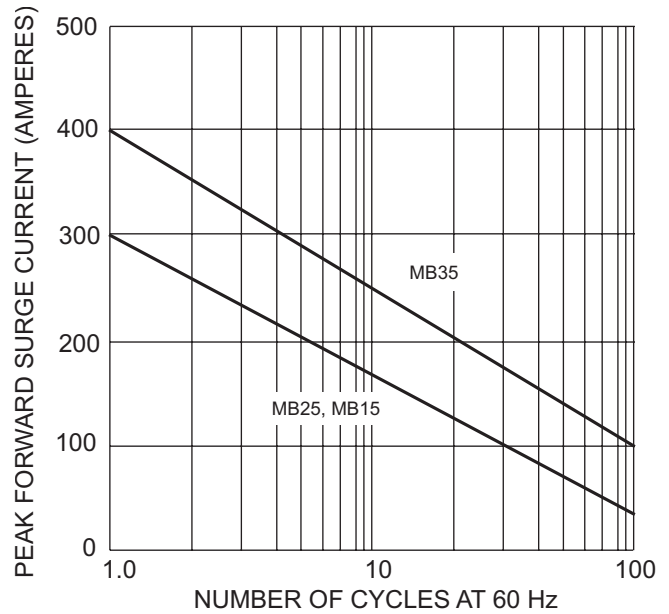

Fig. 4 Maximum Non-Repetitive Peak Forward Surge current

**NOT RECOMMENDED FOR NEW DESIGN, USE  
GBPC15 SERIES, GBPC25 SERIES, OR GBPC35 SERIES**

**Ordering Information** (Note 3)

Device	Packaging	Shipping
MB1505	MB	100/Bulk
MB151	MB	100/Bulk
MB152	MB	100/Bulk
MB154	MB	100/Bulk
MB156	MB	100/Bulk
MB158	MB	100/Bulk
MB1510	MB	100/Bulk
MB1505W	MB-W	100/Bulk
MB151W	MB-W	100/Bulk
MB152W	MB-W	100/Bulk
MB154W	MB-W	100/Bulk
MB156W	MB-W	100/Bulk
MB158W	MB-W	100/Bulk
MB1510W	MB-W	100/Bulk
MB2505	MB	100/Bulk
MB251	MB	100/Bulk
MB252	MB	100/Bulk
MB254	MB	100/Bulk
MB256	MB	100/Bulk
MB258	MB	100/Bulk
MB2510	MB	100/Bulk
MB2505W	MB-W	100/Bulk
MB251W	MB-W	100/Bulk
MB252W	MB-W	100/Bulk
MB254W	MB-W	100/Bulk
MB256W	MB-W	100/Bulk
MB258W	MB-W	100/Bulk
MB2510W	MB-W	100/Bulk
MB3505	MB	100/Bulk
MB351	MB	100/Bulk
MB352	MB	100/Bulk
MB354	MB	100/Bulk
MB356	MB	100/Bulk
MB358	MB	100/Bulk
MB3510	MB	100/Bulk
MB3505W	MB-W	100/Bulk
MB351W	MB-W	100/Bulk
MB352W	MB-W	100/Bulk
MB354W	MB-W	100/Bulk
MB356W	MB-W	100/Bulk
MB358W	MB-W	100/Bulk
MB3510W	MB-W	100/Bulk

Notes: 3. For packaging details, visit our website at <http://www.diodes.com/datasheets/ap2008.pdf>

**IMPORTANT NOTICE**

Diodes, Inc. and its subsidiaries reserve the right to make changes without further notice to any product herein to make corrections, modifications, enhancements, improvements, or other changes. Diodes, Inc. does not assume any liability arising out of the application or use of any product described herein; neither does it convey any license under its patent rights, nor the rights of others. The user of products in such applications shall assume all risks of such use and will agree to hold Diodes Incorporated and all the companies whose products are represented on our website, harmless against all damages.



**LIFE SUPPORT**

The products located on our website at [www.diodes.com](http://www.diodes.com) are not recommended for use in life support systems where a failure or malfunction of the component may directly threaten life or cause injury without the expressed written approval of Diodes Incorporated.

**NOT RECOMMENDED FOR NEW DESIGN, USE  
GBPC15 SERIES, GBPC25 SERIES, OR GBPC35 SERIES**

## Looking for pricing, stock, or lifecycle information?

Click below to explore more details on WIN SOURCE:

-  [View MB1505 on WIN SOURCE](#)
-  [Diodes Incorporated](#) Information

## Optimize Your Supply Chain with WIN SOURCE Solutions

-  Global Sourcing Solution
-  Obsolete Management
-  Cost Control Management
-  Shortage Management
-  Alternative Solution
-  Excess Inventory Management