



THE DATASHEET OF 2SC5868TLQ



Medium power transistor (60V, 0.5A)

2SC5868

●Features

- 1) High speed switching.
(Tf : Typ. : 80ns at Ic = 500mA)
- 2) Low saturation voltage, typically
(Typ. : 75mV at Ic = 100mA, Ib = 10mA)
- 3) Strong discharge power for inductive load and capacitance load.
- 4) Complements the 2SA2090

●Applications

Small signal low frequency amplifier
High speed switching

●Structure

NPN Silicon epitaxial planar transistor

●Packaging specifications

Type	Package	Taping
	Code	TL
	Basic ordering unit (pieces)	3000
2SC5868		○

●Absolute maximum ratings (Ta=25°C)

Parameter		Symbol	Limits	Unit
Collector-base voltage		V _{CB0}	60	V
Collector-emitter voltage		V _{CE0}	60	V
Emitter-base voltage		V _{EB0}	6	V
Collector current	DC	I _c	0.5	A
	Pulsed	I _{cP}	1.0	A *1
Power dissipation		P _c	500	mW *2
Junction temperature		T _j	150	°C
Range of storage temperature		T _{stg}	-55 to 150	°C

*1 Pw=10ms

*2 Each terminal mounted on a recommended land

●External dimensions (Unit : mm)

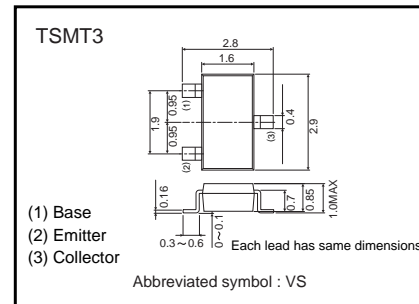

Transistors

●Electrical characteristics (Ta=25°C)

Parameter	Symbol	Min.	Typ.	Max.	Unit	Condition
Collector-emitter breakdown voltage	BV _{CEO}	60	–	–	V	I _C =1mA
Collector-base breakdown voltage	BV _{CBO}	60	–	–	V	I _C =100μA
Emitter-base breakdown voltage	BV _{EBO}	6	–	–	V	I _E =100μA
Collector cut-off current	I _{CBO}	–	–	1.0	μA	V _{CB} =40V
Emitter cut-off current	I _{EBO}	–	–	1.0	μA	V _{EB} =4V
Collector-emitter saturation voltage	V _{CE(sat)}	–	75	300	mV	I _C =100mA I _B =10mA
DC current gain	h _{FE}	120	–	390	–	V _{CE} =2V I _C =50mA
Transition frequency	f _r	–	300	–	MHz	V _{CE} =10V I _E =–100mA f=10MHz
Corrector output capacitance	C _{ob}	–	5	–	pF	V _{CB} =10V I _E =0mA f=1MHz
Turn-on time	T _{on}	–	70	–	ns	I _C =500mA I _{B1} =50mA
Storage time	T _{stg}	–	130	–	ns	I _{B2} =–50mA
Fall time	T _f	–	80	–	ns	V _{CC} ≈25V

*1 Non repetitive pulse

*2 See Switching characteristics measurement circuits

●h_{FE} RANK

Q	R
120–270	180–390

●Electrical characteristic curves

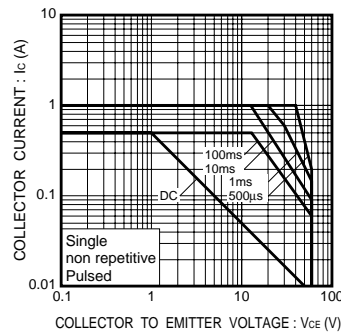

Fig.1 Safe Operating Area

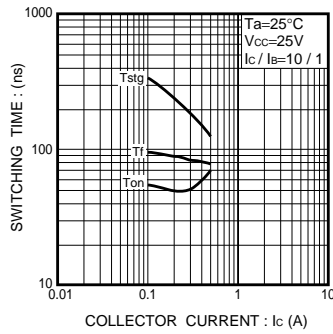

Fig.2 Switching Time

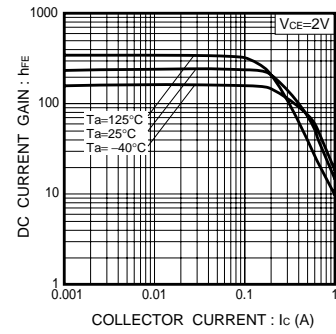

Fig.3 DC Current Gain vs. Collector Current (I)

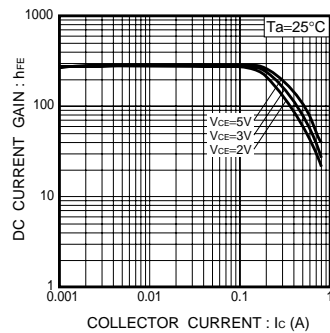

Fig.4 DC Current Gain vs. Collector Current (II)

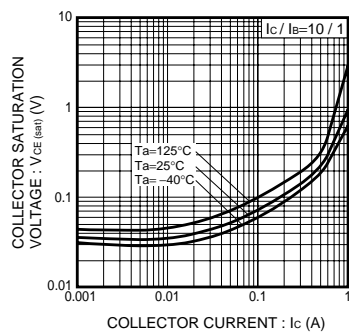

Fig.5 Collector-Emitter Saturation Voltage vs. Collector Current (I)

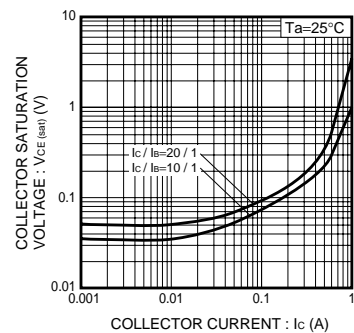

Fig.6 Collector-Emitter Saturation Voltage vs. Collector Current (II)

Transistors

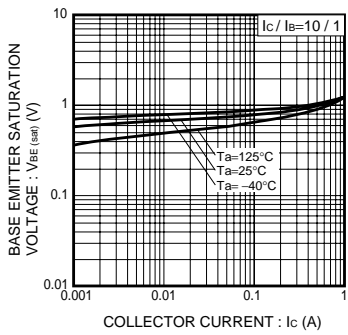

Fig.7 Base-Emitter Saturation Voltage vs. Collector Current

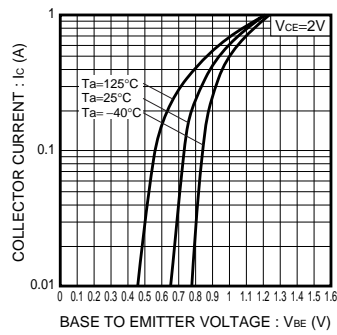

Fig.8 Grounded Emitter Propagation Characteristics

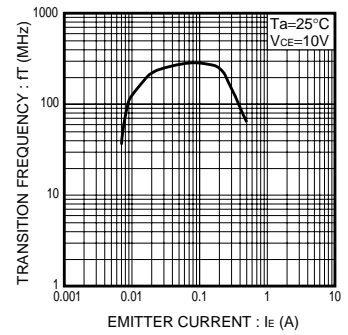

Fig.9 Transition Frequency

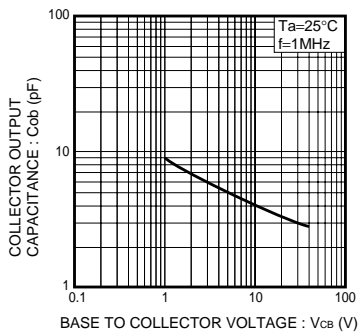
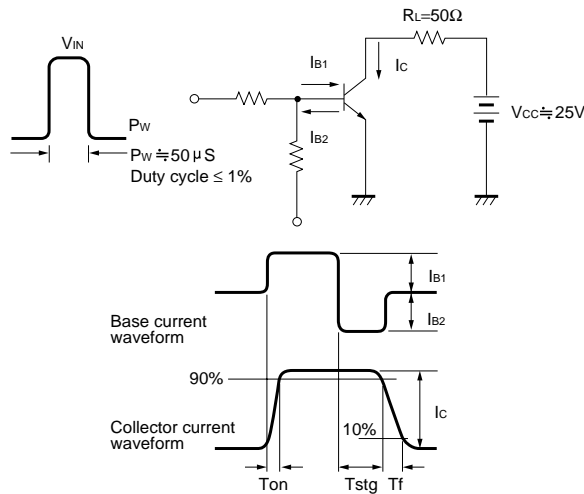

Fig.10 Collector Output Capacitance

●Switching characteristics measurement circuits



Looking for pricing, stock, or lifecycle information?

Click below to explore more details on WIN SOURCE:

- [View 2SC5868TLQ on WIN SOURCE](#)
- [Rohm Semiconductor Information](#)

Optimize Your Supply Chain with WIN SOURCE Solutions

- ✓ Global Sourcing Solution
- ✓ Obsolete Management
- ✓ Cost Control Management
- ✓ Shortage Management
- ✓ Alternative Solution
- ✓ Excess Inventory Management