



**THE DATASHEET OF
MC33186DH1R2**



H-Bridge Driver

The 33186 is a monolithic H-Bridge ideal for fractional horsepower DC-motor and bi-directional thrust solenoid control. The IC incorporates internal control logic, charge pump, gate drive, and low $R_{DS(ON)}$ MOSFET output circuitry. The 33186 is able to control continuous inductive DC load currents up to 5.0 A. Output loads can be pulse width modulated (PWMed) at frequencies up to 10 kHz. This device is powered by SMARTMOS technology.

The 33186 is parametrically specified over a temperature range of $-40\text{ }^{\circ}\text{C} \leq T_A \leq 125\text{ }^{\circ}\text{C}$, $5.0\text{ V} \leq V+ \leq 28\text{ V}$. The IC can also be operated up to 40 V with de-rating of the specifications. The IC is available in a surface mount power package with exposed pad for heat sinking.

Features

- Overtemperature, short-circuit protection, and overvoltage protection against transients up to 40 V at VBAT, typical
- $R_{DS(ON)} = 150\text{ m}\Omega$ for each output transistor at 25 $^{\circ}\text{C}$
- Continuous DC load current 5.0 A ($T_C < 100\text{ }^{\circ}\text{C}$)
- Output current limitation at typ 6.5 A +/- 20%
- Short-circuit shutdown for output currents over 8.0 A
- Logic Inputs TTL/CMOS compatible
- Operating frequency up to 20 kHz
- Undervoltage disable function
- Diagnostic output, 2 disable input
- Coding input for alternative functions
- Stable operation with an external capacitance of 47 μF minimum at VBAT

33186

H-BRIDGE MOTOR DRIVER

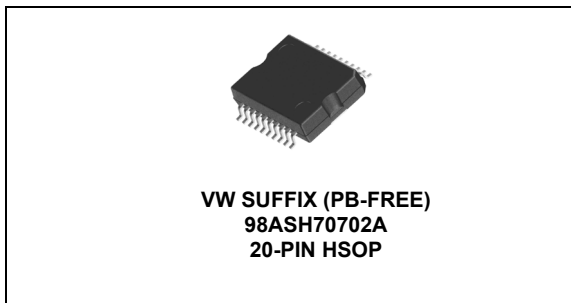

ORDERING INFORMATION		
Device (For Tape and Reel, add an R2 suffix)	Temperature Range (T_A)	Package
MC33186HVW1	-40 to 125 $^{\circ}\text{C}$	20 HSOP
MC33186HVW2		

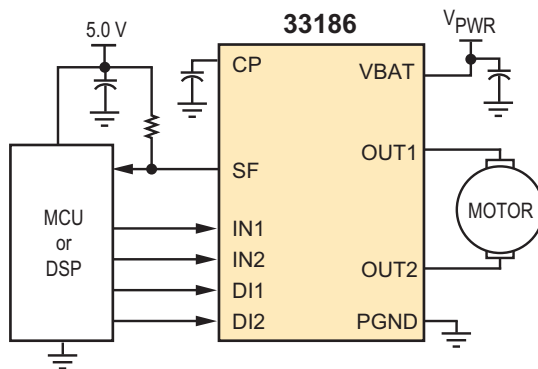

Figure 1. 33186 Simplified Block Diagram

*This document contains certain information on a product under development. Freescale reserves the right to change or discontinue this product without notice

INTERNAL BLOCK DIAGRAM

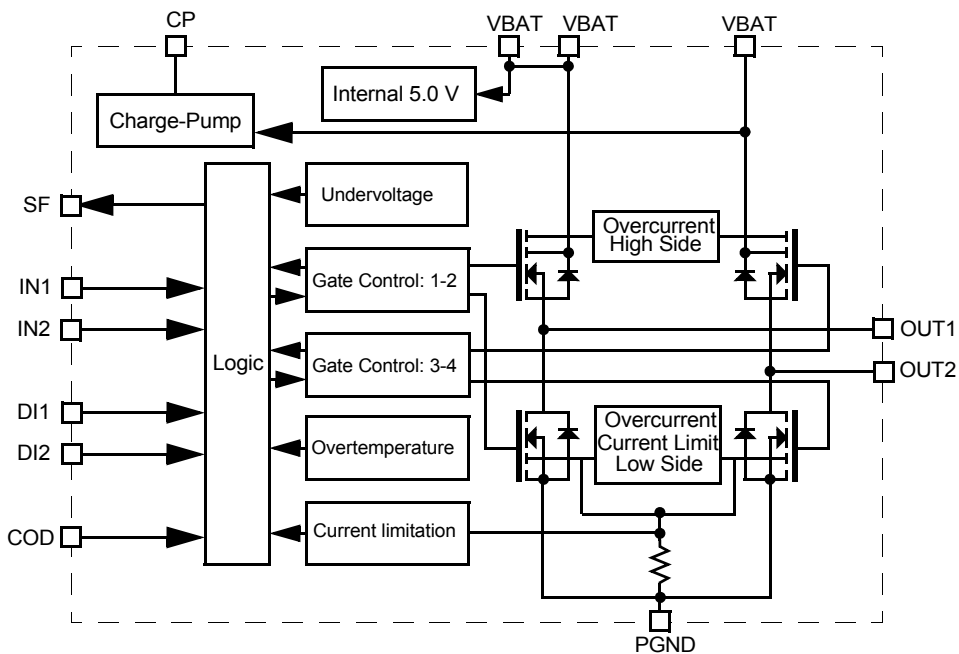

Figure 2. 33186 Simplified Internal Block Diagram

PIN CONNECTIONS

Transparent Top View

Metal slug is connected to power ground

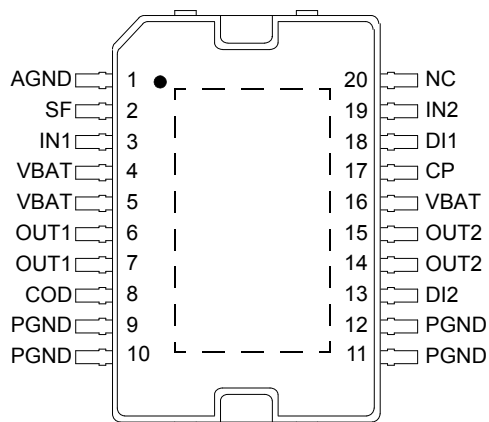

Figure 3. 33186 Pin Locations

Table 1. 33186 Pin Description

Pin	Name	Description
9, 10, 11, 12 Metal slug	PGND	Power Ground. All the ground are connected together, they should be connected as short as possible on the PCB.
1	AGND	Analog ground. All the ground are connected together, they should be connected as short as possible on the PCB.
2	Output Status flag (SF)	Open drain output, active low. Is set according to the truth table. When a fault appears, SF changes typically in less than 100 ms.
3, 13 18, 19	Inputs IN1, IN2, DI1, DI2, COD	Voltage controlled inputs with hysteresis
8	COD	When not connected or connected to GND, a stored failure will be reset by change of the voltage-level on DI1 or DI2. When connected to VCC, the disable Pin DI1 and DI2 are inactive. A stored failure will be reset by change of the voltage level on IN1 or IN2.
6, 7, 14, 15	OUT1, OUT2	H-Bridge outputs with integrated freewheeling diodes.

Table 1. 33186 Pin Description(continued)

Pin	Name	Description
4, 5, 16	VBAT	<p>The Pins 4 and 5 are internally connected. These Pins supply the left high side and the analog/logic part of the device.</p> <p>The Pin 16 supplies the right high side and the charge pump.</p> <p>The Pins 4, 5 and 16 should be connected together on the printed circuit board with connections as short as possible.</p> <p>A V_{BAT} filter capacitor, minimum value 47 μF, should always be employed to prevent IC damage from switching transients.</p> <p>Supervision and protection functions</p> <p>a) Supply voltage supervision</p> <p>The supply voltage is supervised. If it is below its specific threshold, the power stages are switched in tristate and the status flag is switched low.</p> <p>If the supply voltage is over the specific threshold again, the power stage switches independently into normal operation, according to the input Pins and the status flag is reset.</p> <p>b) Thermal supervision</p> <p>In case of overtemperature, the power stages are switched in tristate independent of the inputs signals and the status flag is switched low.</p> <p>If the level changes from high to low on DI1 (IN1) or low to high on DI2 (IN2), the output stage switches on again if the temperature is below the specified limit. The status-flag is reset to high level (Pin names in brackets refer to coding Pin = VCC).</p> <p>c) <i>Supervision of overcurrent on high sides and low sides</i></p> <p>In case of overcurrent detection, the power stages are switched in tristate independent of the inputs signals and the status flag is set.</p> <p>If the level changes from high to low on DI1 (IN1) or low to high on DI2 (IN2) the output stage switches on again and the status flag is reset to high level (Pin names in brackets refer to coding Pin = VCC).</p> <p>The output stage switches into the mode defined by the inputs Pins provided, and/if the temperature is below the specified limits.</p> <p>d) Current limiting on low sides</p> <p>The maximum current which can flow under normal operating conditions is limited to $I_{max} = 6.5 A \pm 20\%$. When the maximum current value is reached, the output stages are switched tristate for a fixed time. According to the time constant the current decreases until the next switch on occurs. See page 9 for schematics.</p>
17	CP	<p>Charge Pump output Pin</p> <p>A filtering capacitor (up to 33 nF) can be connected between Pin 17 and GND. Device can operate without external capacitor, although Pin 17 decoupling capacitor help in noise reduction and allows the device to perform a maximum speed, timing and PWM frequency.</p>

ELECTRICAL CHARACTERISTICS

MAXIMUM RATINGS

Table 2. MAXIMUM RATINGS

All voltages are with respect to ground unless otherwise noted. Exceeding these ratings may cause a malfunction or permanent damage to the device.

Ratings	Symbol	Min	Typ	Max	Unit
---------	--------	-----	-----	-----	------

ELECTRICAL RATINGS

Supply Voltage					V
Static Destruction Proof	V_{BAT}	- 1.0	–	28	
Dynamic Destruction Proof $t < 0,5$ s	V_{Bat}	- 2.0	–	40	
Logic Inputs (IN1, IN2, DI1, DI2, CODE)	U	- 0.5	–	7.0	V
Output Status - Flag SF	U_{SF}	- 0.5	–	7.0	V

THERMAL RATINGS

Junction Temperature	T_J	- 40	–	+150	°C
Storage Temperature	T_S	- 55	–	+125	°C
Ambient Temperature	T_A	- 40	–	+125	°C
Thermal Resistance (with power applied on 2 power MOS)	$R_{th_{JC}}$	–	–	+1.5	K/W
Thermal Resistance (with power applied on 2 power MOS)	$R_{th_{JC}}$	–	–	+1.5	K/W
Peak Package Reflow Temperature During Reflow ^{(1), (2)}	T_{PPRT}	Note 2.			°C

Notes

- Pin soldering temperature limit is for 10 seconds maximum duration. Not designed for immersion soldering. Exceeding these limits may cause malfunction or permanent damage to the device.
- Freescale's Package Reflow capability meets Pb-free requirements for JEDEC standard J-STD-020C. For Peak Package Reflow Temperature and Moisture Sensitivity Levels (MSL), Go to www.freescale.com, search by part number [e.g. remove prefixes/suffixes and enter the core ID to view all orderable parts. (i.e. MC33xxxD enter 33xxx), and review parametrics.

STATIC ELECTRICAL CHARACTERISTICS

Table 3. STATIC ELECTRICAL CHARACTERISTICS

Characteristic noted under conditions -40 °C to +125 °C, V_{BAT} from 5.0 V to 28 V, unless otherwise note. Typical values reflect approximate mean at 25 °C, nominal V_{CC}, at time of device characterization.

Characteristics	Symbol	Min	Typ	Max	Unit
POWER SUPPLY					
Operating Range:					V
Static	V _{BAT}	5.0	–	28	
Dynamic (t < 500 ms)	V _{BAT}	–	–	40	
Stand-by current f = 0 to 10 kHz; I _{OUT} = 0.0 A	I _{V_{BAT}}	–	–	35	mA
V _{BAT} -undervoltage switch-off (without load)					
Switch-off Voltage		4.15	4.4	4.65	V
Switch-on Voltage		4.5	4.75	5.0	V
Hysteresis		150	–	–	mV
CHARGE-PUMP SUPPLY					
V _{BAT} = 4.15 V	V _{CP} - V _{BAT}	3.35	–	–	V
V _{BAT} < 40 V	V _{CP} - V _{BAT}	–	–	20	
LOGIC INPUTS					
Input High	V _{INH}	3.4	–	–	V
Input Low	V _{INL}	–	–	1.4	V
Input Hysteresis	U	0.7	1.0	–	V
Input Pull-up Current (IN1, IN2, DI1) U _{IN} = 0.0 V	I	- 200	- 80	–	μA
Input Pull-down Current (DI2,COD) ⁽³⁾ U _{DI2} = 5.0 V	I _{DI2}	–	25	100	μA
POWER OUTPUTS: OUT1, OUT2					
Switch on resistance: R _{OUT - V_{BAT}} ; R _{OUT - GND} V _{BAT} = 5.0 to 28 V; CCP = 0 to 33 nF		–	–	300	mΩ
Switch-off Current during Current Limitation on Low Sides	(I _{OUT}) MAX	5.2	6.5	7.8	A
Switch-off Time during Current Limitation on Low Sides	t _A	15	20.5	26	μs
Blanking Time during Current Limitation on Low Sides	t _B	12	16.5	21	μs

Notes

- In case of negative voltage at OUT2 (respectively OUT1) this maximum pull down current at DI2 (respectively COD) Pin can be exceeded. This happens during recirculation when the current is flowing in the low side. See [Figure 22](#).

Table 3. STATIC ELECTRICAL CHARACTERISTICS(continued)

Characteristic noted under conditions -40 °C to +125 °C, VBAT from 5.0 V to 28 V, unless otherwise note. Typical values reflect approximate mean at 25 °C, nominal V_{CC}, at time of device characterization.

Characteristics	Symbol	Min	Typ	Max	Unit
High Side Overcurrent Detection ⁽⁴⁾	I _{OCHS}	11	–	–	A
Low Side Overcurrent Detection	I _{OCLS}	8.0	–	–	
Leakage Current Output Stage Switched off		–	–	100	μA
Freewheeling Diode Forward Voltage IOU = 3.0 A	U _D	–	–	2.0	V
Freewheeling Diode Reverse Recovery Time IFM = 1.0 A, di/dt = 4.0 A/μs	t _{RR}	–	2.0	5.0	μs
Switch-off Temperature Hysteresis		160 20	– –	190 30	°C

OUTPUT STATUS FLAG (OPEN DRAIN OUTPUT)

Output High (SF not set) USF = 5.0 V	I _{SF}	–	–	10	μA
Output Low (SF set) ISF = 300 μA	V _{SF}	–	–	1.0	V

TIMING

PWM frequency CCP = 33 nF	f	–	–	10	kHz
Maximum Switching Frequency During Current Limitation VBAT = 6...28 V...CCP = 33 nF	f	–	–	20	kHz
Output ON Delay IN1.....>OUT1 or IN2.....>OUT2	t _{DON}	–	–	15	μs
Output OFF Delay IN1.....>OUT1 or IN2.....>OUT2	t _{DOFF}	–	–	15	μs
Output Switching Time CCP = 0 to 33 nF OUTiH.....OUTiL, OUTiL.....OUTiH, IOU = 3.0 A	t _r , t _f	2.0	–	5.0	μs
Disable Delay Time Dli.....OUTi	t _{DDIS}	–	–	8.0	μs
Turn off in Case of Overcurrent or Overtemperature		–	4.0	8.0	μs
Power On Delay Time (CCP = 33 nF) ⁽⁵⁾		–	1.0	5.0	ms

Notes

- In case of overcurrent, the time when the current is greater than 7.8 A is lower than 30 μs, with a maximum frequency of 1.0 kHz.
- This parameter corresponds to the time for CCP to reach its nominal value when VBAT is applied.

TRUTH TABLE

Table 4. Truth Table

Device State	Input Conditions				Status		Outputs	
	DI1 ⁽⁸⁾	DI2 ⁽⁸⁾	IN1	IN2	SF ⁽⁹⁾	SF ⁽¹⁰⁾	OU1	OU2
1-Forward	L	H	H	L	H	H	H	L
2-Reverse	L	H	L	H	H	H	L	H
3-Free Wheeling Low	L	H	L	L	H	H	L	L
4-Free Wheeling High	L	H	H	H	H	H	H	H
5-Disable 1	H	X	X	X	L	H	Z	Z
6-Disable 2	X	L	X	X	L	H	Z	Z
7-IN1 Disconnected	L	H	Z	X	H	H	H	X
8-IN2 Disconnected	L	H	X	Z	H	H	X	H
9-DI1 Disconnected	Z	X	X	X	L	H	Z	Z
10-DI2 Disconnected	X	Z	X	X	L	H	Z	Z
11-Current Limit.active	L	H	X	X	H	H	Z	Z
12-Undervoltage ⁽⁶⁾	X	X	X	X	L	L	Z	Z
13-Overtemperature ⁽⁷⁾	X	X	X	X	L	L	Z	Z
14-Overcurrent ⁽⁷⁾	X	X	X	X	L	L	Z	Z

Notes

6. In case of undervoltage, tristate and status-flag are reset automatically.
7. Whenever overcurrent or overtemperature is detected, the fault is stored (i.e.status-flag remains low). The tristate conditions and the status-flag are reset via DI1 (IN1) or DI2 (IN2). Pin names in brackets refer to coding Pin (COD = VCC).
8. If COD = VCC then DI1 and DI2 are not active.
9. COD = nc or GND
10. COD = VCC

L = Low

H = High

X = High or Low

Z = High impedance (all output stage transistors are switched off).

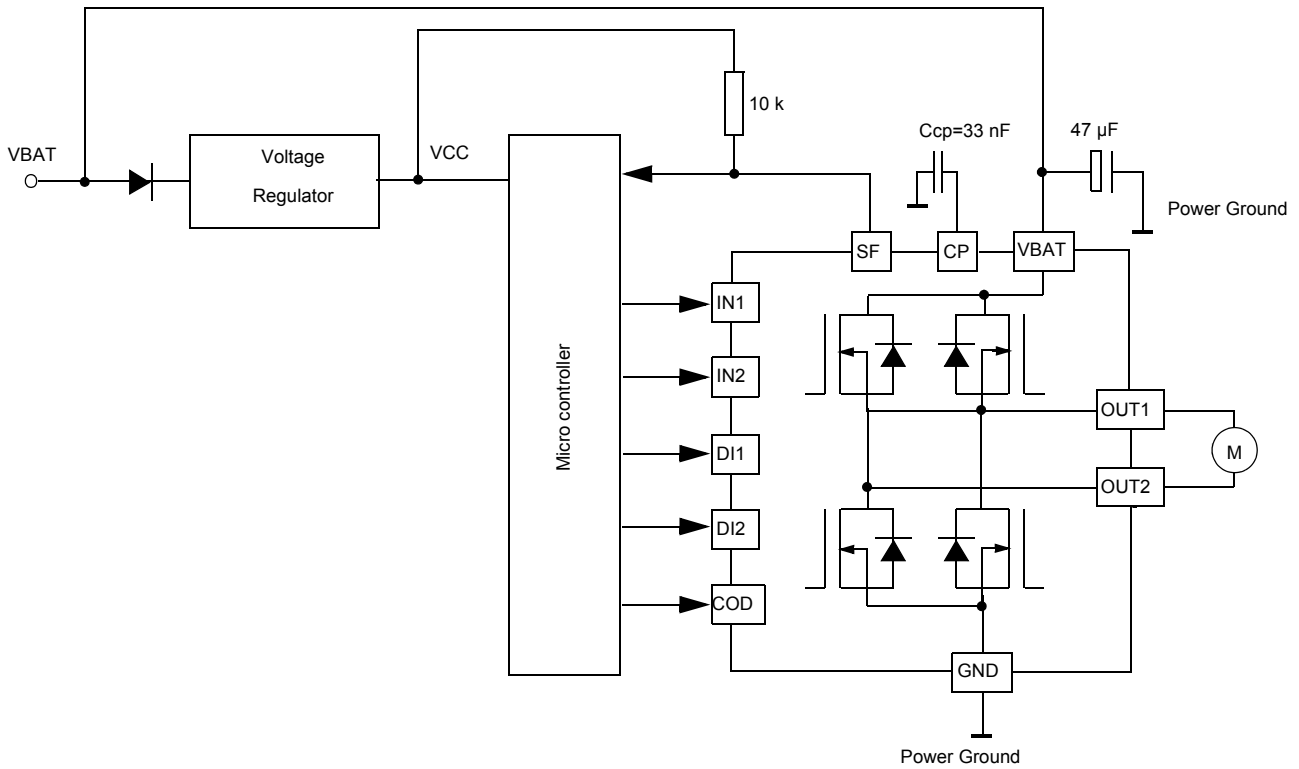

Figure 4. Typical Application

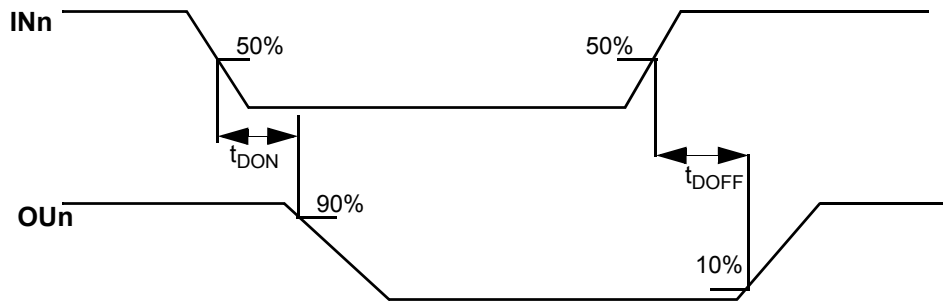

Figure 5. Output Delay Time

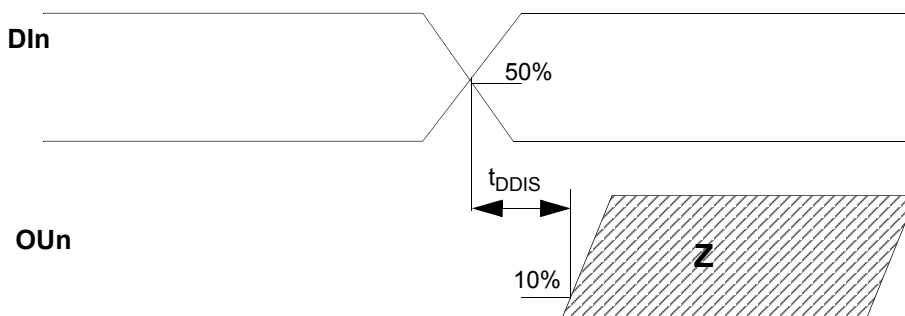

Figure 6. Disable Delay Time

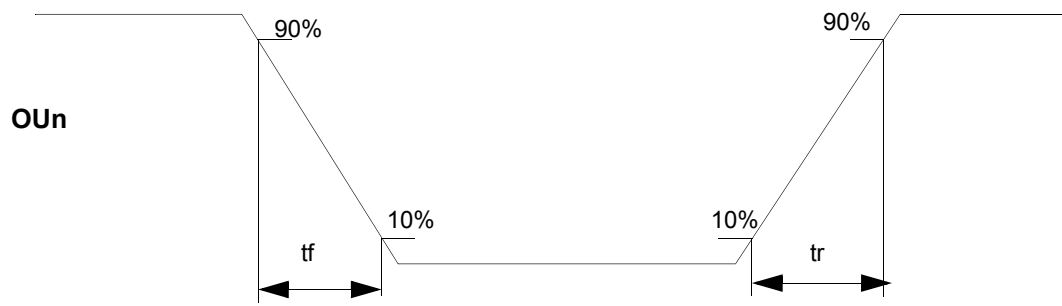

Figure 7. Output Switching Time

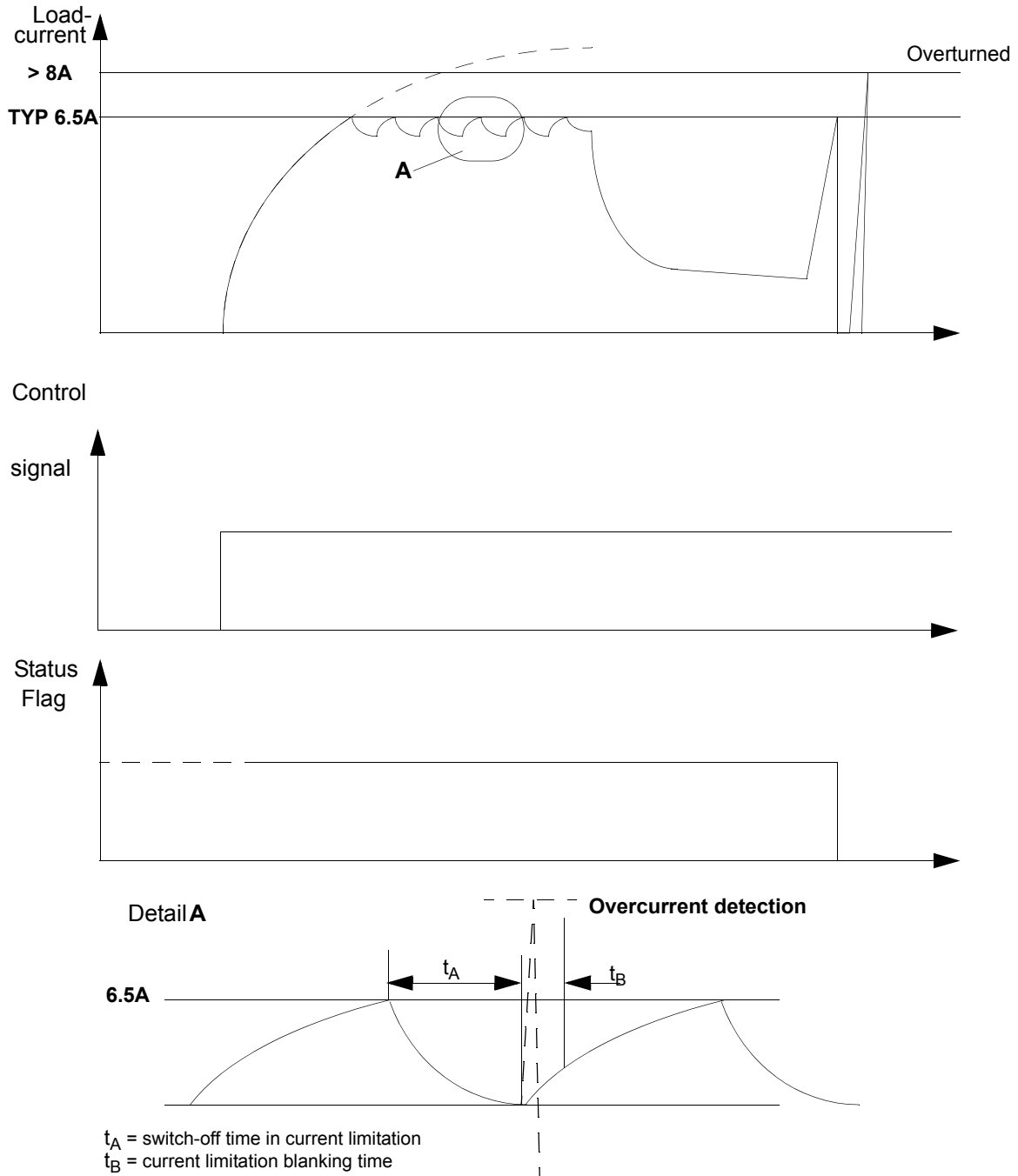

Figure 8. Current Limitation on Low Side

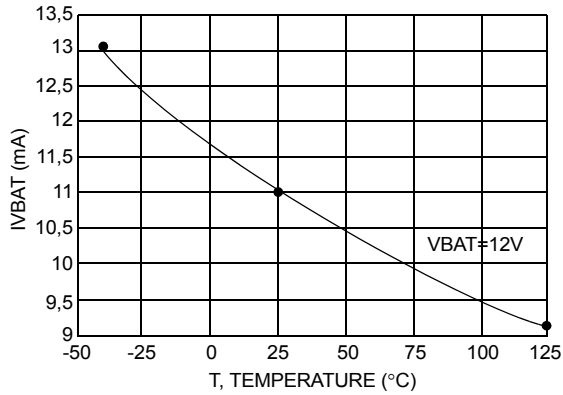

Figure 9. Stand-by Current vs. Temperature

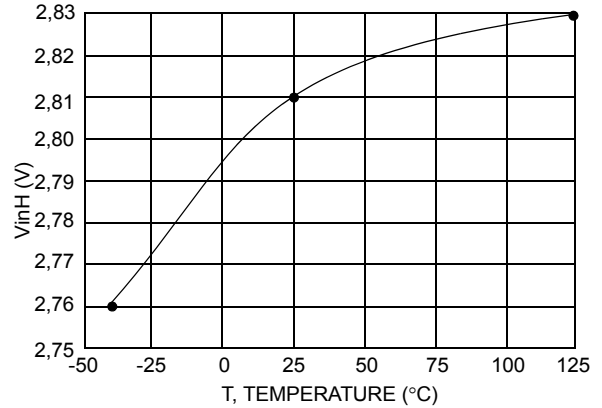

Figure 12. High Threshold Input Voltage vs. Temperature

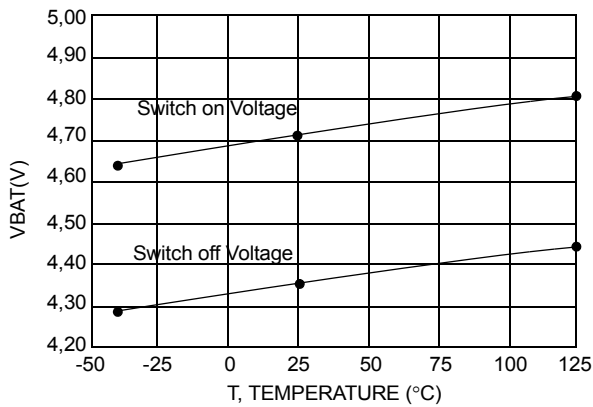

Figure 10. VBAT Undervoltage vs. Temperature

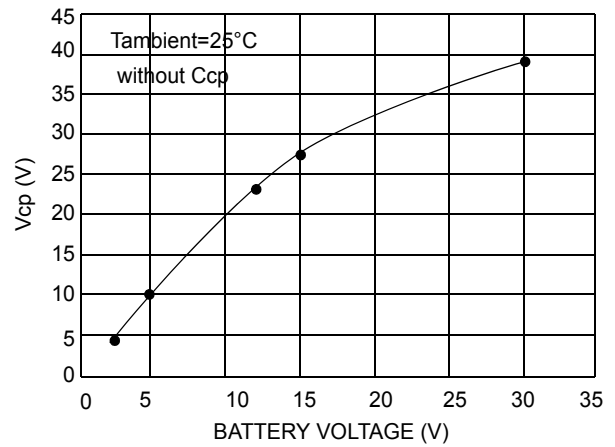

Figure 13. Vcp vs. Battery Voltage

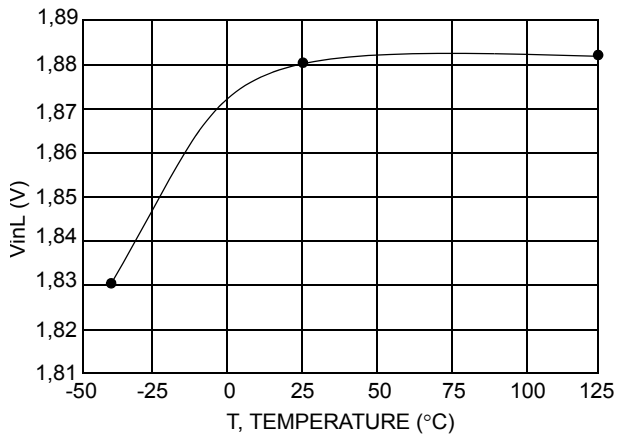

Figure 11. Low Threshold Input Voltage vs. Temperature

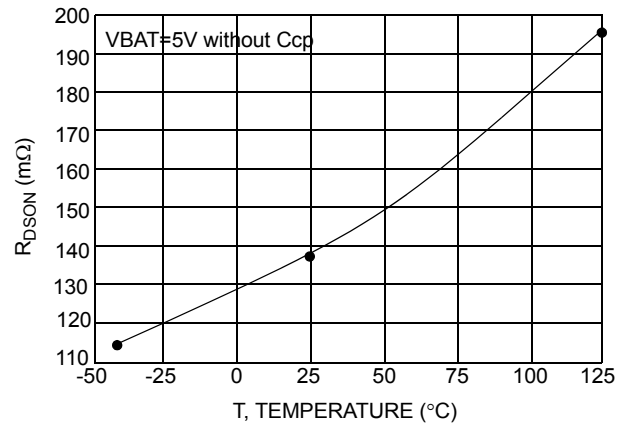

Figure 14. R_DS(on) vs. Temperature

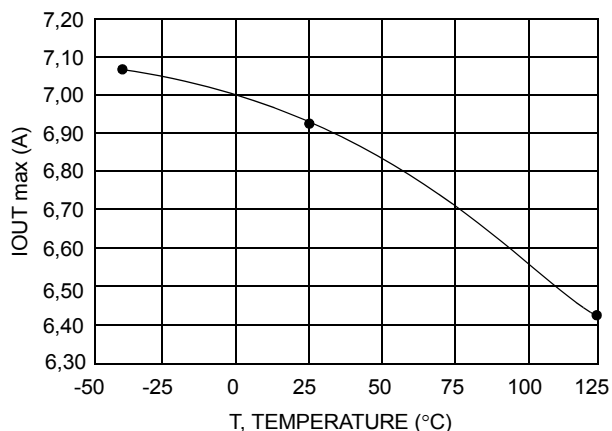

Figure 15. Switch off Current vs. Temperature

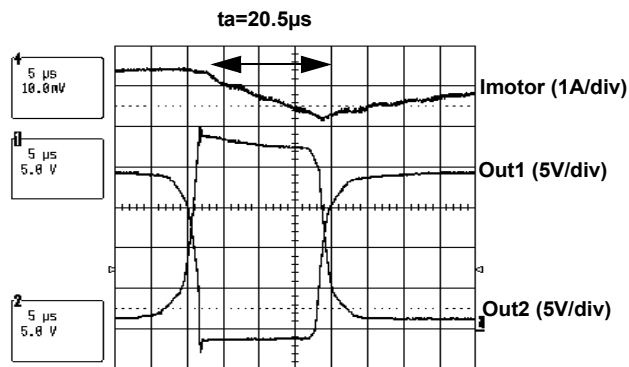

Figure 18. Switch off Time

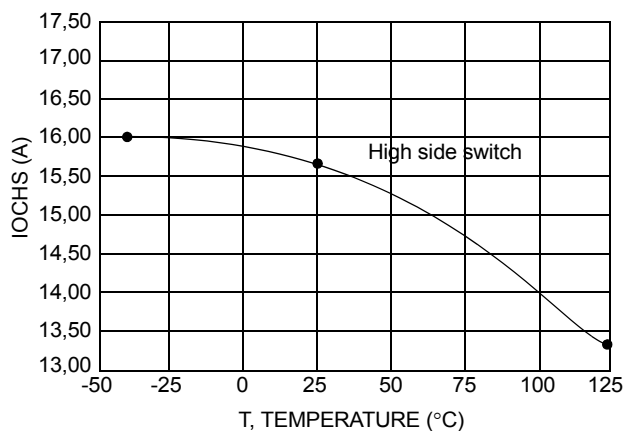

Figure 16. Overcurrent Detection vs. Temperature

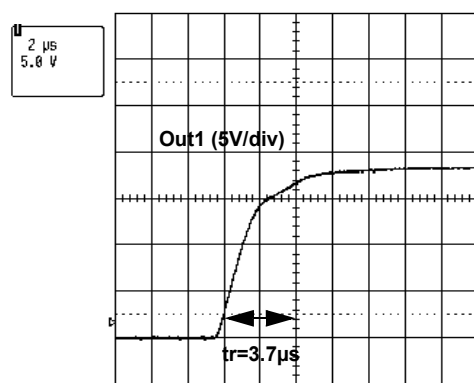

Figure 19. Output Switching Time: T_R

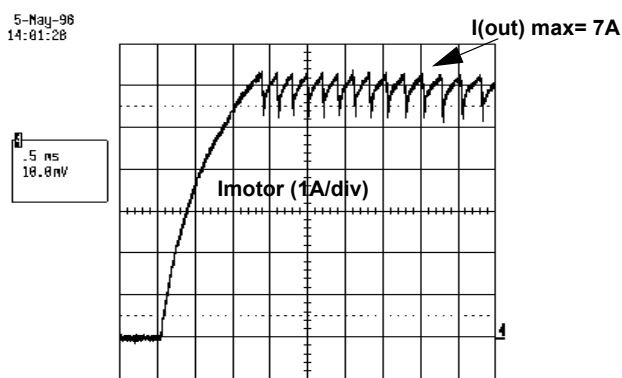

Figure 17. Current Limitation

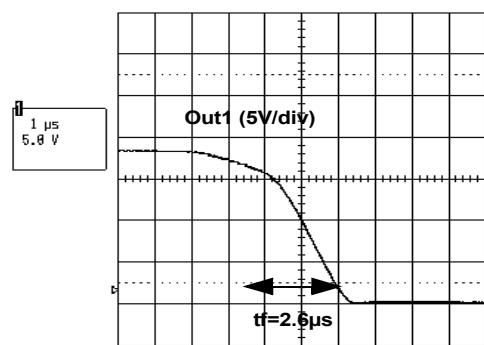

Figure 20. Output Switching Time: T_F

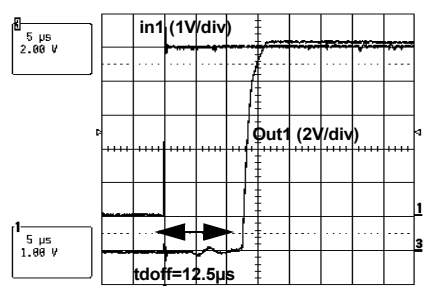

Figure 21. Output OFF Delay

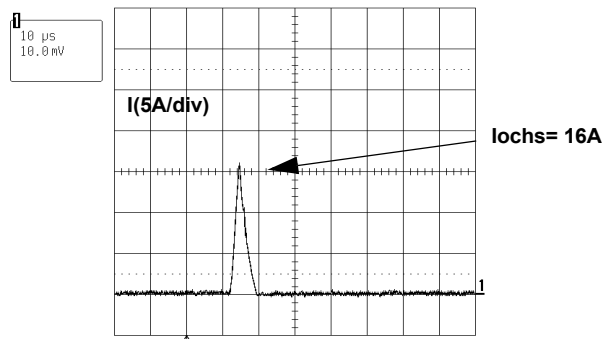

Figure 24. High Side Overcurrent High Side Detection

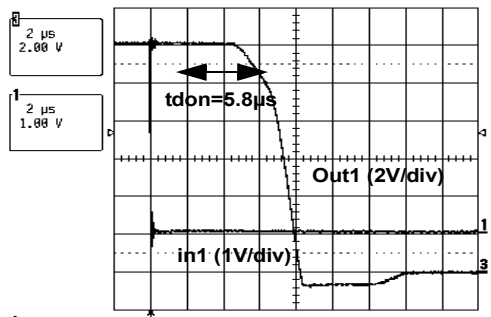
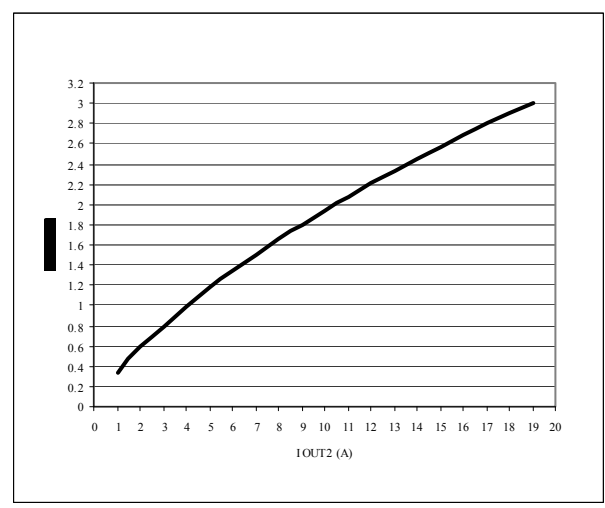

Figure 22. Output ON Delay



Note: Current through internal recirculation diode, @125°C in case of negative voltage at OUT2

Figure 25. Maximum Di2 Input Current vs. I_{OUT2} , current

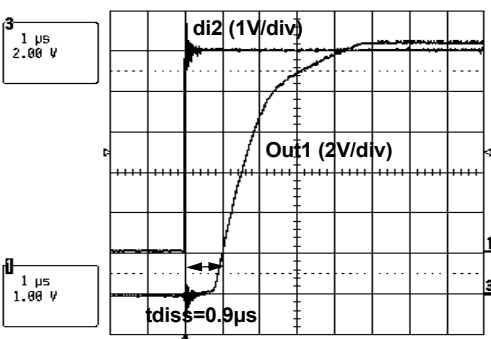

Figure 23. Disable Delay Time

PACKAGING

SOLDERING

The 20 HSOP package is designed for enhanced thermal performance. The particularity of this package is its copper base plate on which the power die is soldered. The base plate is soldered on a PCB to provide heat flow to the ambient and also to provide a large thermal capacitance.

Of course, the more copper area on the PCB, the better the power dissipation and transient behavior.

We characterized the 20 HSOP on a double side PCB. The bottom side area of the copper is 7.8 cm². The top surface is 2.7 cm², see [Figure 26](#).

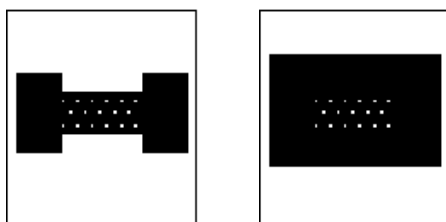

Top Side

Bottom Side

Figure 26. PCB Test Layout

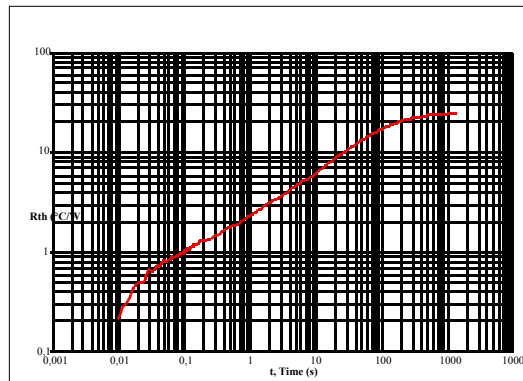

Figure 27. PHSOP20 Thermal Response

[Figure 27](#) shows the thermal response with the device soldered on to the test PCB described on [Figure 26](#).

PACKAGE DIMENSIONS

Important: Package dimensions are provided in package drawings. To find the most current package outline drawing, go to www.freescale.com and perform a keyword search for the drawing's document number.

Table 5. Package Drawing Information

Package	Suffix	Package Outline Drawing Number
20-PIN HSOP	HVW	98ASH70702A

Dimensions shown are provided for reference ONLY (For Layout and Design, refer to the Package Outline Drawing listed in the following figures).

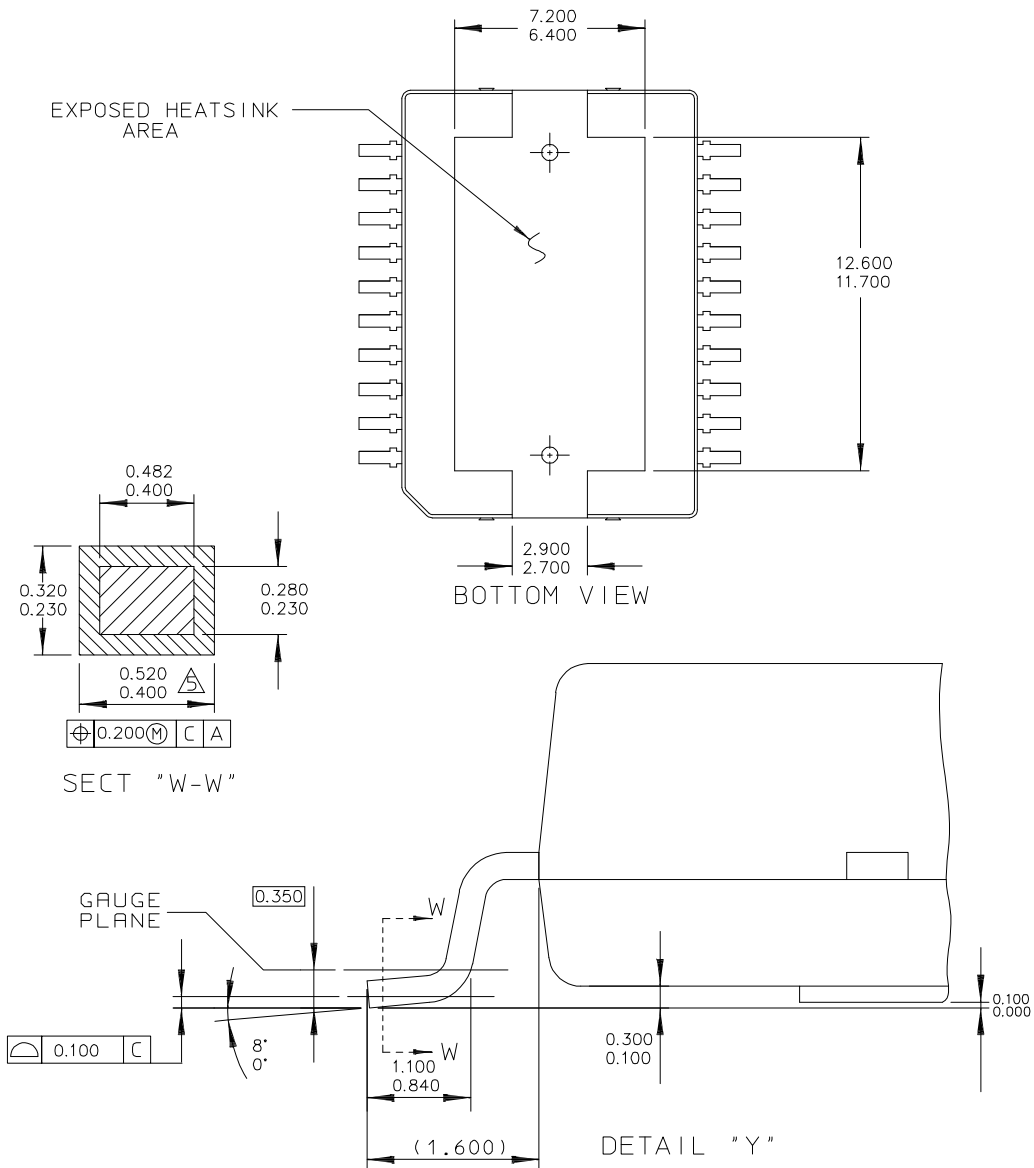

© FREESCALE SEMICONDUCTOR, INC. ALL RIGHTS RESERVED.	MECHANICAL OUTLINE	PRINT VERSION NOT TO SCALE	
TITLE: 20 LEAD HSOP W/PROTRUDING HEATSINK	DOCUMENT NO: 98ASH70702A	REV: C	
	CASE NUMBER: 979	11 OCT 2011	
	STANDARD: NON-JEDEC		

VW (Pb-FREE) SUFFIX
20-PIN HSOP
98ASH70702A
ISSUE C

NOTES:

1. CONTROLLING DIMENSION: MILLIMETER.
2. DIMENSIONS AND TOLERANCES PER ASME Y14.5M-1994.
3. DATUM PLANE H IS LOCATED AT BOTTOM OF THE LEAD AND IS COINCIDENT WITH THE LEAD WHERE THE LEAD EXITS THE PLASTIC BODY AT THE BOTTOM OF THE PARTING LINE.
4. THIS DIMENSION DOES NOT INCLUDE MOLD PROTRUSION. ALLOWABLE MOLD PROTRUSION IS 0.150 PER SIDE. THIS DIMENSION DOES INCLUDE MOLD MISMATCH AND IS DETERMINED AT DATUM H.
5. DIMENSION DOES NOT INCLUDE DAMBAR PROTRUSION. ALLOWABLE DAMBAR PROTRUSION IS 0.127 TOTAL IN EXCESS OF THE DIMENSION AT MAXIMUM MATERIAL CONDITION.
6. DATUM A AND B TO BE DETERMINED AT DATUM PLANE H.
7. DIMENSION DOES NOT INCLUDE TIEBAR PROTRUSIONS. ALLOWABLE TIEBAR PROTRUSIONS ARE 0.150 PER SIDE.
8. THIS DIMENSION DOES NOT INCLUDE MOLD PROTRUSION. ALLOWABLE MOLD PROTRUSION IS 0.250 PER SIDE. THIS DIMENSION DOES INCLUDE MOLD MISMATCH AND IS DETERMINED AT DATUM H.

© FREESCALE SEMICONDUCTOR, INC. ALL RIGHTS RESERVED.	MECHANICAL OUTLINE	PRINT VERSION NOT TO SCALE	
TITLE: 20 LEAD HSOP W/PROTRUDING HEATSINK	DOCUMENT NO: 98ASH70702A	REV: C	
	CASE NUMBER: 979	11 OCT 2011	
	STANDARD: NON JEDEC		

VW (Pb-FREE) SUFFIX
20-PIN HSOP
98ASH70702A
ISSUE C

ADDITIONAL DOCUMENTATION

33186VW

**20-PIN
 HSOP-EP**

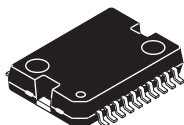

**VW SUFFIX (Pb-FREE)
 98ASH70273A
 20-PIN HSOP-EP**

Note For package dimensions, refer to the 33186 data sheet.

THERMAL ADDENDUM (REV 2.0)

Introduction

This thermal addendum is provided as a supplement to the MC33186 technical datasheet. The addendum provides thermal performance information that may be critical in the design and development of system applications. All electrical, application, and packaging information is provided in the datasheet.

Package and Thermal Considerations

The MC33186 is offered in a 20 pin HSOP exposed pad, single die package. There is a single heat source (P), a single junction temperature (T_J), and thermal resistance (R_{θJA}).

$$\{ T_J \} = [R_{\theta JA}] \cdot \{ P \}$$

The stated values are solely for a thermal performance comparison of one package to another in a standardized environment. This methodology is not meant to and will not predict the performance of a package in an application-specific environment. Stated values were obtained by measurement and simulation according to the standards listed below.

Standards

Table 6. Thermal Performance Comparison

Thermal Resistance	[°C/W]
R _{θJA} (1), (2)	29
R _{θJB} (2), (3)	9.0
R _{θJA} (1), (4)	69
R _{θJC} (5)	2.0

Notes:

- Per JEDEC JESD51-2 at natural convection, still air condition.
- 2s2p thermal test board per JEDEC JESD51-5 and JESD51-7.
- Per JEDEC JESD51-8, with the board temperature on the center trace near the center lead.
- Single layer thermal test board per JEDEC JESD51-3 and JESD51-5.
- Thermal resistance between the die junction and the exposed pad surface; cold plate attached to the package bottom side, remaining surfaces insulated.

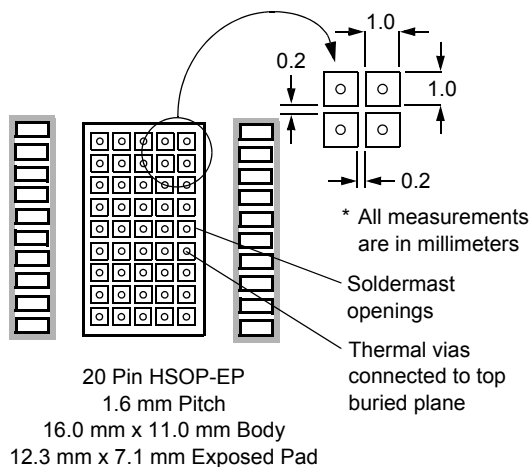

Figure 28. Thermal Land Pattern for Direct Thermal Attachment According to JESD51-5

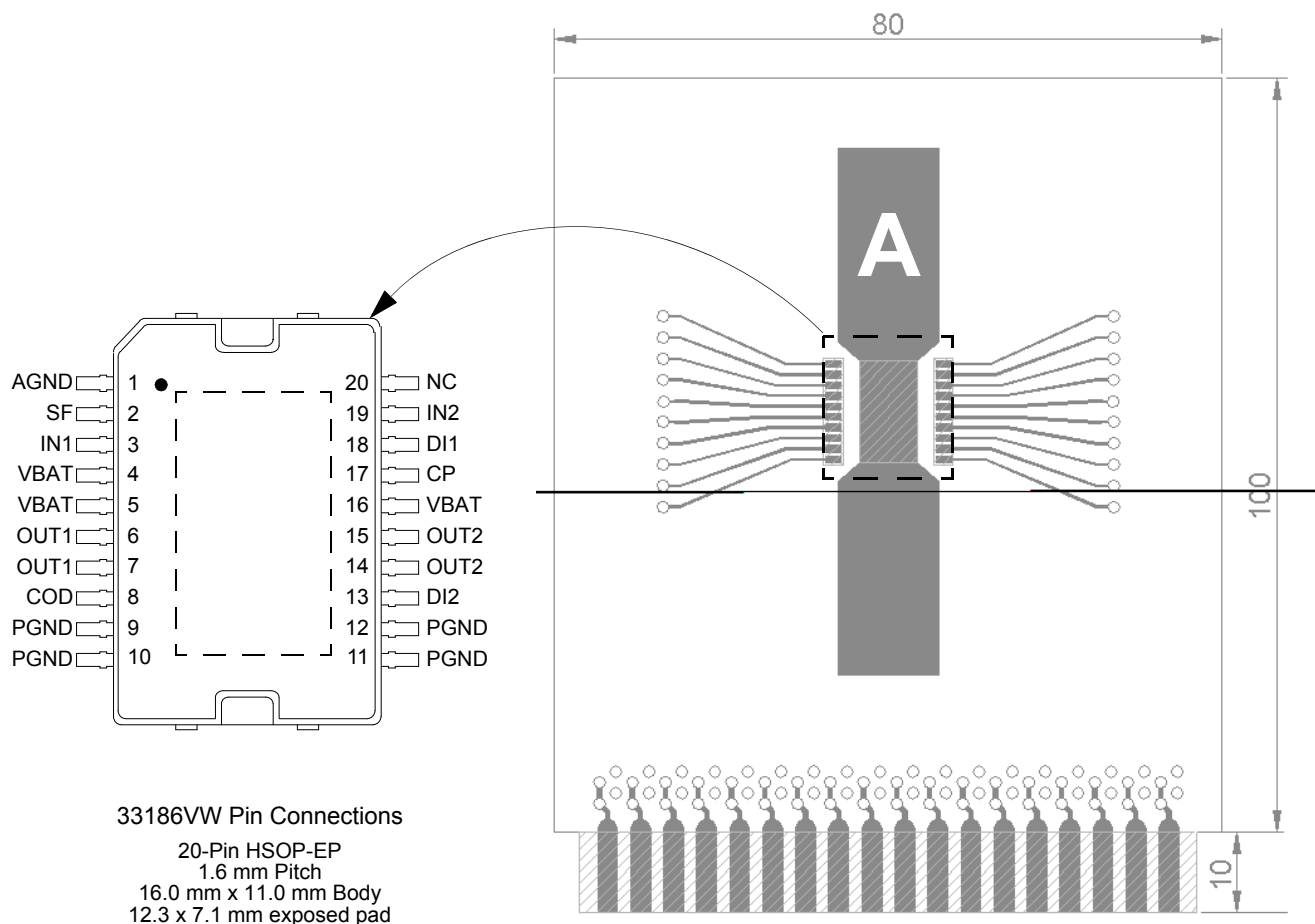

Figure 29. Thermal Test Board

Device on Thermal Test Board

- Material: Single layer printed circuit board
FR4, 1.6 mm thickness
Cu traces, 0.07 mm thickness
- Outline: 80 mm x 100 mm board area,
including edge connector for
thermal testing
- Area A: Cu heat-spreading areas on board
surface
- Ambient Conditions: Natural convection, still air

Table 7. Thermal Resistance Performance

A [mm ²]	R _{θJA} [°C/W]
0	70
300	49
600	47

R_{θJA} is the thermal resistance between die junction and ambient air.

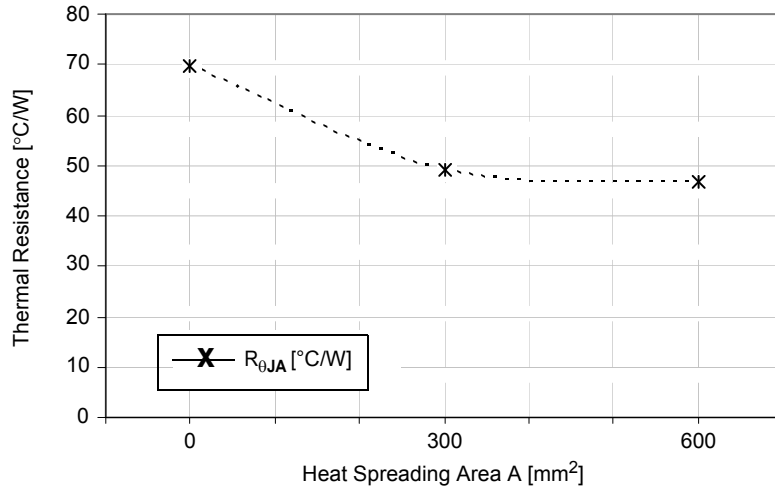
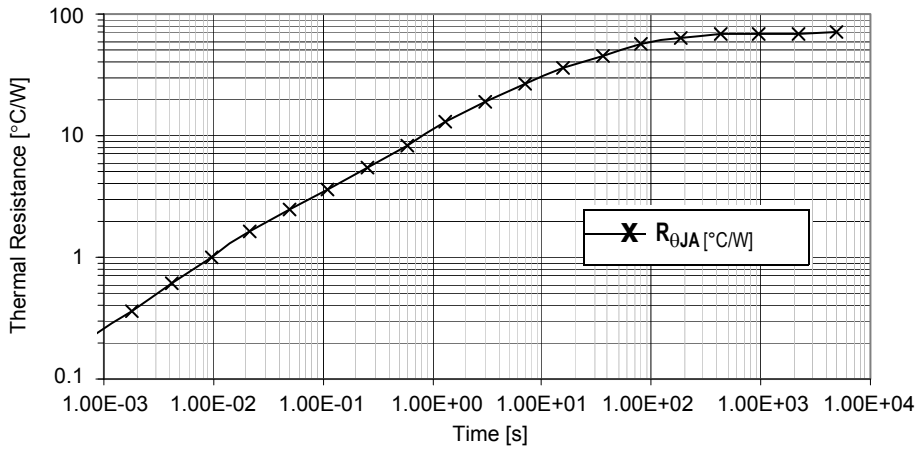

Figure 30. Device on Thermal Test Board $R_{\theta JA}$



**Figure 31. Transient Thermal Resistance $R_{\theta JA}$
 1 W Step Response, Device on Thermal Test Board Area A = 600 (mm²)**

REVISION HISTORY

REVISION	DATE	DESCRIPTION OF CHANGES
5.0	5/2006	<ul style="list-style-type: none"> • Implemented Revision History page • Added Lead Free (Pb-Free) Part Number MC33186VW1
6.0	10/2006	<ul style="list-style-type: none"> • Updated data sheet formal • Removed Peak Package Reflow Temperature During Reflow (solder reflow) parameter from MAXIMUM RATINGS on page 5. Added note with instructions to obtain this information from www.freescale.com.
7.0	10/2011	<ul style="list-style-type: none"> • Updated Package Dimensions according to the latest Freescale package specification 98ASH70702A_C • Updated to the current Freescale form and style.
8.0	4/2013	<ul style="list-style-type: none"> • Removed MC33186DH1 and MC33186VW1 from the ordering information and added MC33186HVW1 and MC33186HVW2 to the ordering information • Added the sentence "A V_{BAT} filter capacitor, minimum value 47 μF, should always be employed to prevent IC damage from switching transients." for pins 4,5 , and 16 in Table 1 • Revised back page. Updated document properties. Added SMARTMOS sentence to first paragraph. Updated form and style.



How to Reach Us:

Home Page:
freescale.com

Web Support:
freescale.com/support

Information in this document is provided solely to enable system and software implementers to use Freescale products. There are no express or implied copyright licenses granted hereunder to design or fabricate any integrated circuits on the information in this document.

Freescale reserves the right to make changes without further notice to any products herein. Freescale makes no warranty, representation, or guarantee regarding the suitability of its products for any particular purpose, nor does Freescale assume any liability arising out of the application or use of any product or circuit, and specifically disclaims any and all liability, including without limitation consequential or incidental damages. "Typical" parameters that may be provided in Freescale data sheets and/or specifications can and do vary in different applications, and actual performance may vary over time. All operating parameters, including "typicals," must be validated for each customer application by customer's technical experts. Freescale does not convey any license under its patent rights nor the rights of others. Freescale sells products pursuant to standard terms and conditions of sale, which can be found at the following address: <http://www.reg.net/v2/webservices/Freescale/Docs/TermsandConditions.htm>

Freescale and the Freescale logo, are trademarks of Freescale Semiconductor, Inc., Reg. U.S. Pat. & Tm. Off. SMARTMOS is a trademark of Freescale Semiconductor, Inc. All other product or service names are the property of their respective owners.

© 2013 Freescale Semiconductor, Inc.

Document Number: MC33186
Rev. 8.0
4/2013



Looking for pricing, stock, or lifecycle information?

Click below to explore more details on WIN SOURCE:

- ⊖ [View MC33186DH1R2 on WIN SOURCE](#)
- ⊖ [Freescale Semiconductor - NXP Information](#)

Optimize Your Supply Chain with WIN SOURCE Solutions

- ✓ Global Sourcing Solution
- ✓ Obsolete Management
- ✓ Cost Control Management
- ✓ Shortage Management
- ✓ Alternative Solution
- ✓ Excess Inventory Management