



**THE DATASHEET OF  
MC33275D-3.3R2G**



# MC33275, NCV33275

## 300 mA, Low Dropout Voltage Regulator

The MC33275 series are micropower low dropout voltage regulators available in a wide variety of output voltages as well as packages, SOT-223, SOP-8, DPAK, and DFN 4x4 surface mount packages. These devices feature a very low quiescent current and are capable of supplying output currents up to 300 mA. Internal current and thermal limiting protection are provided by the presence of a short circuit at the output and an internal thermal shutdown circuit.

Due to the low input-to-output voltage differential and bias current specifications, these devices are ideally suited for battery powered computer, consumer, and industrial equipment where an extension of useful battery life is desirable.

### Features

- Low Input-to-Output Voltage Differential of 25 mV at  $I_O = 10$  mA, and 260 mV at  $I_O = 300$  mA
- Extremely Tight Line and Load Regulation
- Stable with Output Capacitance of only 0.33  $\mu$ F for 2.5 V Output Voltage
- Internal Current and Thermal Limiting
- NCV Prefix for Automotive and Other Applications Requiring Unique Site and Control Change Requirements; AEC-Q100 Qualified and PPAP Capable
- These are Pb-Free Devices

### Applications

- Battery Powered Consumer Products
- Hand-Held Instruments
- Camcorders and Cameras

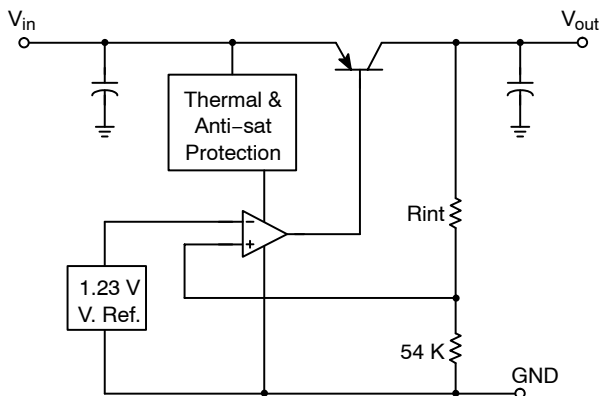

This device contains 41 active transistors

Figure 1. Simplified Block Diagram



ON Semiconductor®

[www.onsemi.com](http://www.onsemi.com)

## LOW DROPOUT MICROPOWER VOLTAGE REGULATOR

### MARKING DIAGRAMS

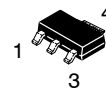

SOT-223  
ST SUFFIX  
CASE 318E

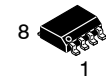
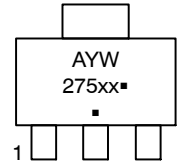

SOIC-8  
D SUFFIX  
CASE 751

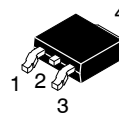
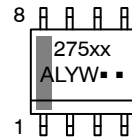

DPAK  
DT SUFFIX  
CASE 369C

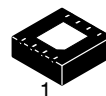
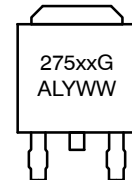

DFN-8, 4x4  
MN SUFFIX  
CASE 488AF

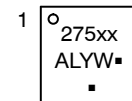

xx = Voltage Version  
A = Assembly Location  
L = Wafer Lot  
Y = Year  
W, WW = Work Week  
▪ or G = Pb-Free Device  
(Note: Microdot may be in either location)

### ORDERING INFORMATION

See detailed ordering and shipping information on page 10 of this data sheet.

# MC33275, NCV33275

## PIN CONNECTIONS



MC33275ST



MC33275DT



Pins 4 and 5 Not Connected

MC33275D

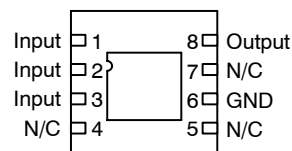

MC33275MN

## MAXIMUM RATINGS

Rating	Symbol	Value	Unit
Input Voltage	$V_{CC}$	13	Vdc
Power Dissipation and Thermal Characteristics $T_A = 25^\circ\text{C}$			
Maximum Power Dissipation	$P_D$	Internally Limited	W
Case 751 (SOIC-8) D Suffix			
Thermal Resistance, Junction-to-Ambient	$R_{\theta JA}$	160	$^\circ\text{C/W}$
Thermal Resistance, Junction-to-Case	$R_{\theta JC}$	25	$^\circ\text{C/W}$
Case 318E (SOT-223) ST Suffix			
Thermal Resistance, Junction-to-Air	$R_{\theta JA}$	245	$^\circ\text{C/W}$
Thermal Resistance, Junction-to-Case	$R_{\theta JC}$	15	$^\circ\text{C/W}$
Case 369A (DPAK-3) DT Suffix			
Thermal Resistance, Junction-to-Air	$R_{\theta JA}$	92	$^\circ\text{C/W}$
Thermal Resistance, Junction-to-Case	$R_{\theta JC}$	6.0	$^\circ\text{C/W}$
Case 488AF (DFN-8, 4x4) MN Suffix			
Thermal Resistance, Junction-to-Air (with 1.0 oz PCB cu area)	$R_{\theta JA}$	183	$^\circ\text{C/W}$
Thermal Resistance, Junction-to-Air (with 1.8 oz PCB cu area)	$R_{\theta JA}$	93	$^\circ\text{C/W}$
Thermal Resistance, Junction-to-Case	psi-JC*	9.0	$^\circ\text{C/W}$
Output Current	$I_O$	300	mA
Maximum Junction Temperature	$T_J$	150	$^\circ\text{C}$
Operating Ambient Temperature Range	$T_A$	- 40 to +125	$^\circ\text{C}$
Storage Temperature Range	$T_{stg}$	- 65 to +150	$^\circ\text{C}$
Electrostatic Discharge Sensitivity (ESD)	ESD		V
Human Body Model (HBM)		4000	
Machine Model (MM)		400	

Stresses exceeding those listed in the Maximum Ratings table may damage the device. If any of these limits are exceeded, device functionality should not be assumed, damage may occur and reliability may be affected.

\*"C" ("case") is defined as the solder-attach interface between the center of the exposed pad on the bottom of the package, and the board to which it is attached.

# MC33275, NCV33275

## ELECTRICAL CHARACTERISTICS ( $C_L = 1.0\mu\text{F}$ , $T_A = 25^\circ\text{C}$ , for min/max values $T_J = -40^\circ\text{C}$ to $+125^\circ\text{C}$ , Note 1)

Characteristic	Symbol	Min	Typ	Max	Unit
Output Voltage $I_O = 0\text{ mA to }250\text{ mA}$ 2.5 V Suffix $T_A = 25^\circ\text{C}$ , $V_{in} = [V_O + 1]\text{ V}$ 3.0 V Suffix 3.3 V Suffix 5.0 V Suffix  2.5 V Suffix $V_{in} = [V_O + 1]\text{ V}$ , $0 < I_O < 100\text{ mA}$ 3.0 V Suffix 2% Tolerance from $T_J = -40$ to $+125^\circ\text{C}$ 3.3 V Suffix 5.0 V Suffix	$V_O$	2.475 2.970 3.267 4.950  2.450 2.940 3.234 4.900	2.50 3.00 3.30 5.00  – – – –	2.525 3.030 3.333 5.05  2.550 3.060 3.366 5.100	Vdc
Line Regulation $V_{in} = [V_O + 1]\text{ V to }12\text{ V}$ , $I_O = 250\text{ mA}$ , All Suffixes $T_A = 25^\circ\text{C}$	$\text{Reg}_{line}$	–	2.0	10	mV
Load Regulation $V_{in} = [V_O + 1]\text{ V}$ , $I_O = 0\text{ mA to }250\text{ mA}$ , All Suffixes $T_A = 25^\circ\text{C}$	$\text{Reg}_{load}$	–	5.0	25	mV
Dropout Voltage $I_O = 10\text{ mA}$ $T_J = -40^\circ\text{C to }+125^\circ\text{C}$ $I_O = 100\text{ mA}$ $I_O = 250\text{ mA}$ $I_O = 300\text{ mA}$	$V_{in} - V_O$	– – – –	25 115 220 260	100 200 400 500	mV
Ripple Rejection (120 Hz) $V_{in(\text{peak-peak})} = [V_O + 1.5]\text{ V to }[V_O + 5.5]\text{ V}$	–	65	75	–	dB
Output Noise Voltage $C_L = 1.0\mu\text{F}$ $I_O = 50\text{ mA}$ (10 Hz to 100 kHz) $C_L = 200\mu\text{F}$	$V_n$	– –	160 46	– –	$\mu\text{Vrms}$

## CURRENT PARAMETERS

Quiescent Current ON Mode $V_{in} = [V_O + 1]\text{ V}$ , $I_O = 0\text{ mA}$	$I_{QOn}$	–	125	200	$\mu\text{A}$
Quiescent Current ON Mode SAT 3.0 V Suffix $V_{in} = [V_O - 0.5]\text{ V}$ , $I_O = 0\text{ mA}$ (Notes 2, 3) 3.3 V Suffix 5.0 V Suffix	$I_{QSAT}$	– – –	1500 1500 1500	2000 2000 2000	$\mu\text{A}$
Current Limit $V_{in} = [V_O + 1]\text{ V}$ , $V_O$ Shorted	$I_{LIMIT}$	–	450	–	mA

## THERMAL SHUTDOWN

Thermal Shutdown	–	–	150	–	$^\circ\text{C}$
------------------	---	---	-----	---	------------------

Product parametric performance is indicated in the Electrical Characteristics for the listed test conditions, unless otherwise noted. Product performance may not be indicated by the Electrical Characteristics if operated under different conditions.

- Low duty pulse techniques are used during test to maintain junction temperature as close to ambient as possible.
- Quiescent Current is measured where the PNP pass transistor is in saturation.  $V_{in} = [V_O - 0.5]\text{ V}$  guarantees this condition.
- For 2.5 V version,  $I_{QSAT}$  is constrained by the minimum input voltage of 2.5 V.

## DEFINITIONS

**Load Regulation** – The change in output voltage for a change in load current at constant chip temperature.

**Dropout Voltage** – The input/output differential at which the regulator output no longer maintains regulation against further reductions in input voltage. Measured when the output drops 100 mV below its nominal value (which is measured at 1.0 V differential), dropout voltage is affected by junction temperature, load current and minimum input supply requirements.

**Output Noise Voltage** – The RMS AC voltage at the output with a constant load and no input ripple, measured over a specified frequency range.

**Maximum Power Dissipation** – The maximum total dissipation for which the regulator will operate within specifications.

**Quiescent Current** – Current which is used to operate the regulator chip and is not delivered to the load.

**Line Regulation** – The change in output voltage for a change in the input voltage. The measurement is made under conditions of low dissipation or by using pulse techniques such that the average chip temperature is not significantly affected.

**Maximum Package Power Dissipation** – The maximum package power dissipation is the power dissipation level at which the junction temperature reaches its maximum value i.e. 150°C. The junction temperature is rising while the difference between the input power ( $V_{CC} \times I_{CC}$ ) and the output power ( $V_{out} \times I_{out}$ ) is increasing.

Depending on ambient temperature, it is possible to calculate the maximum power dissipation and so the maximum current as following:

$$P_d = \frac{T_J - T_A}{R_{\theta JA}}$$

The maximum operating junction temperature  $T_J$  is specified at 150°C, if  $T_A = 25^\circ\text{C}$ , then  $P_D$  can be found. By neglecting the quiescent current, the maximum power dissipation can be expressed as:

$$I_{out} = \frac{P_D}{V_{CC} - V_{out}}$$

The thermal resistance of the whole circuit can be evaluated by deliberately activating the thermal shutdown of the circuit (by increasing the output current or raising the input voltage for example).

Then you can calculate the power dissipation by subtracting the output power from the input power. All variables are then well known: power dissipation, thermal shutdown temperature and ambient temperature.

$$R_{\theta JA} = \frac{T_J - T_A}{P_D}$$

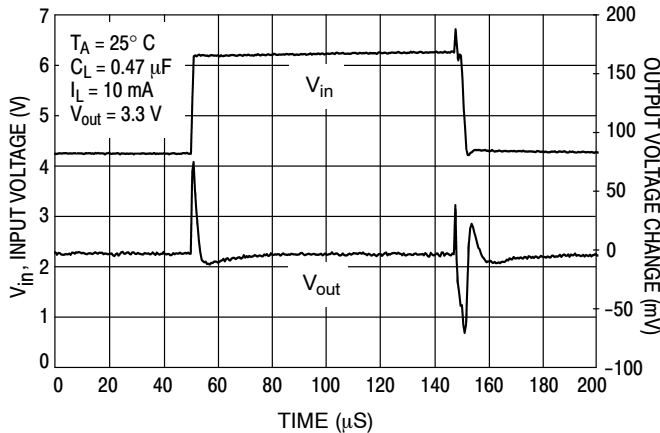

Figure 2. Line Transient Response

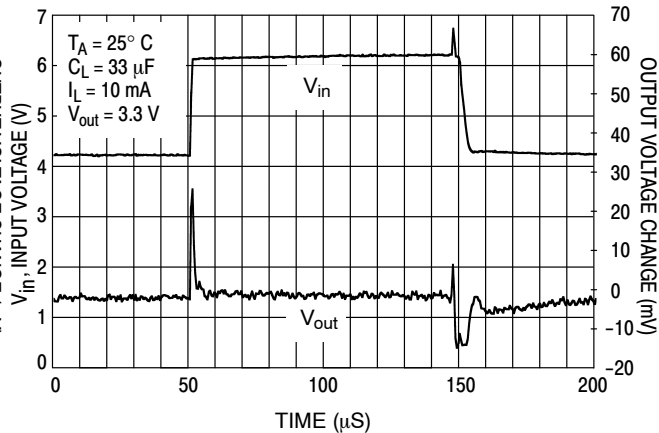

Figure 3. Line Transient Response

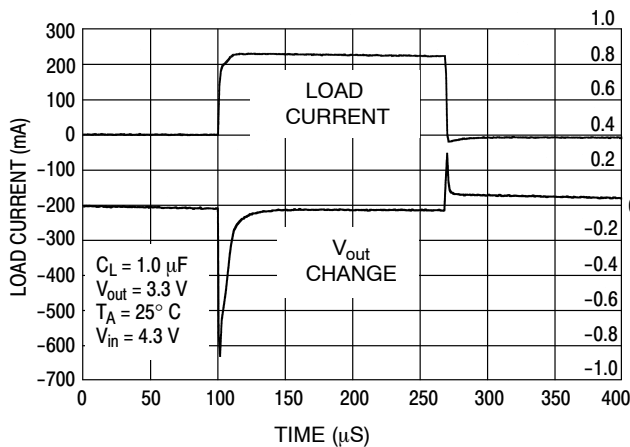

Figure 4. Load Transient Response

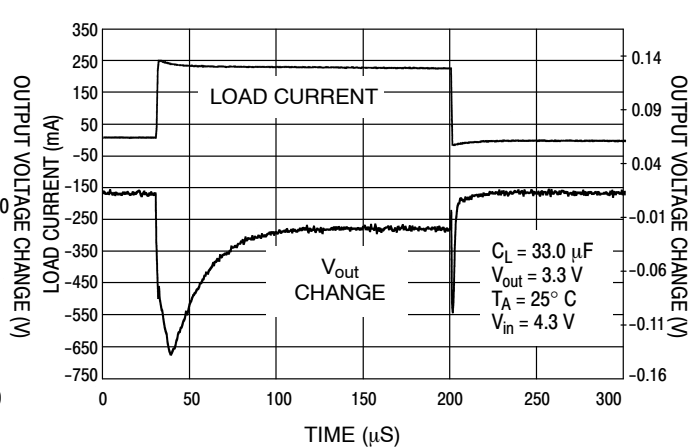

Figure 5. Load Transient Response

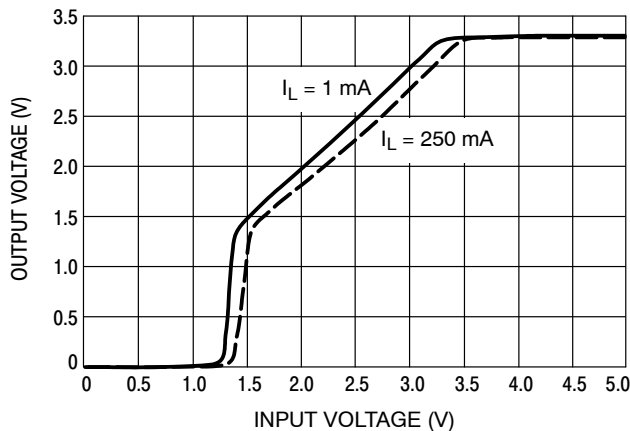

Figure 6. Output Voltage versus Input Voltage

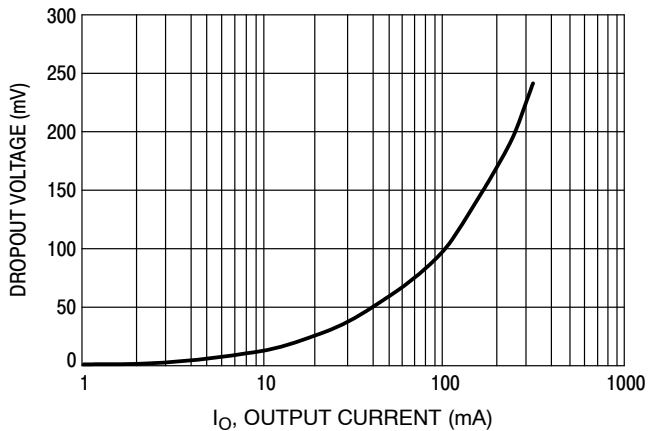

Figure 7. Dropout Voltage versus Output Current

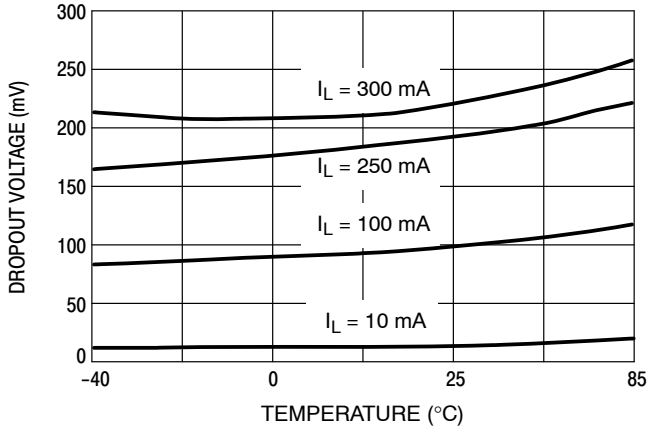

Figure 8. Dropout Voltage versus Temperature

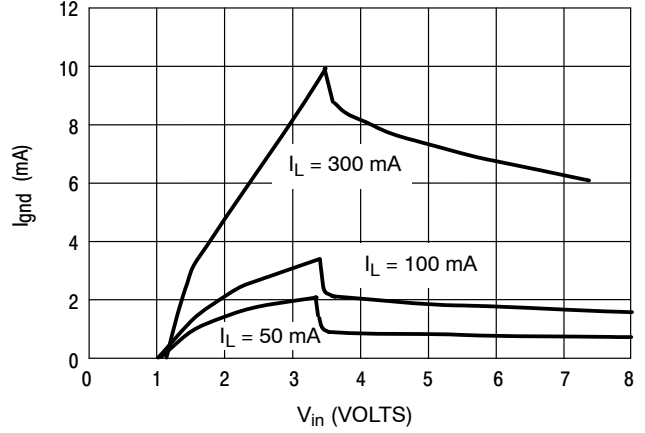

Figure 9. Ground Pin Current versus Input Voltage

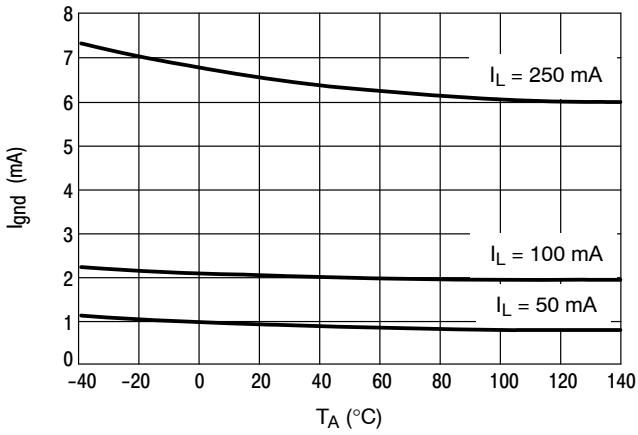

Figure 10. Ground Pin Current versus Ambient Temperature

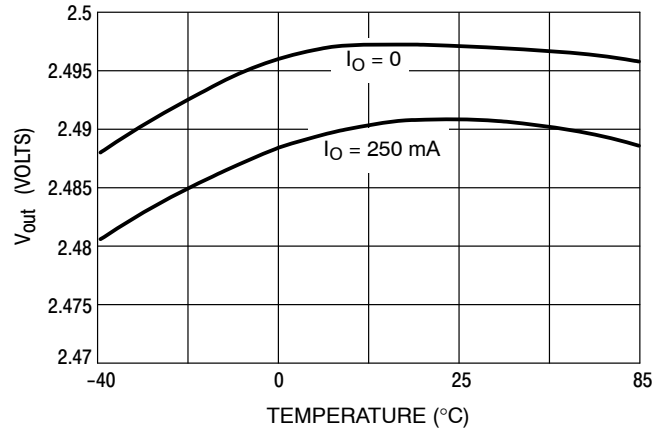
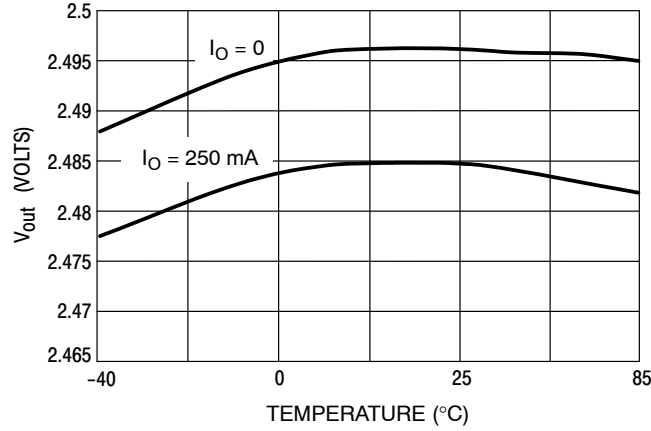

Figure 11. Output Voltage versus Ambient Temperature ( $V_{in} = V_{out} + 1V$ )

# MC33275, NCV33275



**Figure 12. Output Voltage versus Ambient Temperature (V<sub>in</sub> = 12 V)**



**Figure 13. Ripple Rejection**



**Figure 14. Ripple Rejection**

## APPLICATIONS INFORMATION

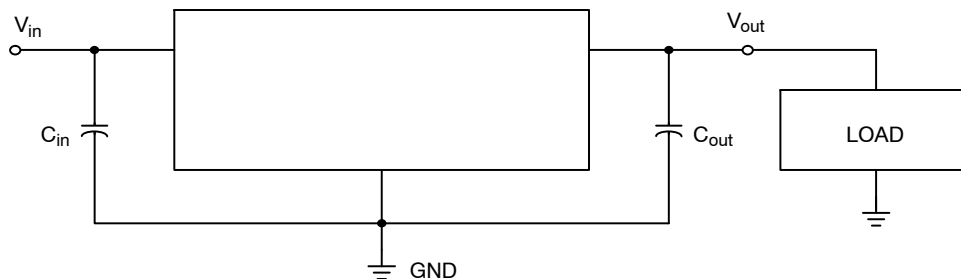
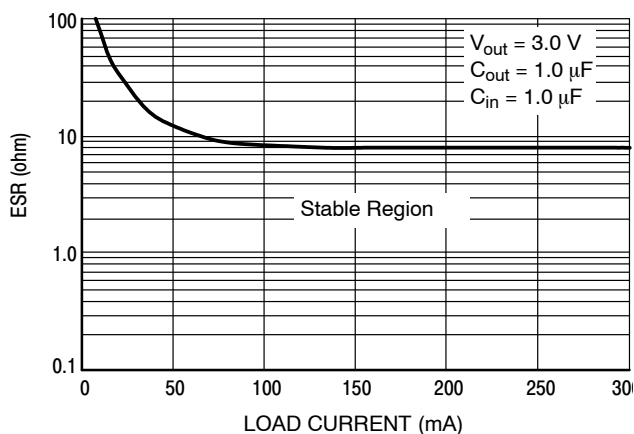

Figure 15. Typical Application Circuit

The MC33275 regulators are designed with internal current limiting and thermal shutdown making them user-friendly. Figure 15 is a typical application circuit. The output capability of the regulator is in excess of 300 mA, with a typical dropout voltage of less than 260 mV. Internal protective features include current and thermal limiting.

**EXTERNAL CAPACITORS**

These regulators require only a 0.33  $\mu\text{F}$  (or greater) capacitance between the output and ground for stability for 1.8 V, 2.5 V, 3.0 V, and 3.3 V output voltage options. Output voltage options of 5.0 V require only 0.22  $\mu\text{F}$  for stability. The output capacitor must be mounted as close as possible to the MC33275. If the output capacitor must be mounted further than two centimeters away, then a larger value of output capacitor may be required for stability. A value of 0.68  $\mu\text{F}$  or larger is recommended. Most type of aluminum, tantalum, or multilayer ceramic will perform adequately. Solid tantalums or appropriate multilayer ceramic capacitors are recommended for operation below 25°C. An input bypass capacitor is recommended to improve transient response or if the regulator is connected to the supply input filter with long wire lengths, more than 4 inches. This will reduce the circuit's sensitivity to the input line impedance at high frequencies. A 0.33  $\mu\text{F}$  or larger tantalum, mylar, ceramic, or other capacitor having low internal impedance at high frequencies should be chosen. The bypass capacitor should be mounted with shortest possible lead or track length directly across the regulator's input terminals. Figure 16 shows the ESR that allows the LDO to remain stable for various load currents.

Figure 16. ESR for  $V_{\text{out}} = 3.0\text{V}$ 

Applications should be tested over all operating conditions to insure stability.

**THERMAL PROTECTION**

Internal thermal limiting circuitry is provided to protect the integrated circuit in the event that the maximum junction temperature is exceeded. When activated, typically at 150°C, the output is disabled. There is no hysteresis built into the thermal protection. As a result the output will appear to be oscillating during thermal limit. The output will turn off until the temperature drops below the 150°C then the output turns on again. The process will repeat if the junction increases above the threshold. This will continue until the existing conditions allow the junction to operate below the temperature threshold.

**Thermal limit is not a substitute for proper heatsinking.**

The internal current limit will typically limit current to 450 mA. If during current limit the junction exceeds 150°C, the thermal protection will protect the device also. **Current limit is not a substitute for proper heatsinking.**

**OUTPUT NOISE**

In many applications it is desirable to reduce the noise present at the output. Reducing the regulator bandwidth by increasing the size of the output capacitor will reduce the noise.

# MC33275, NCV33275

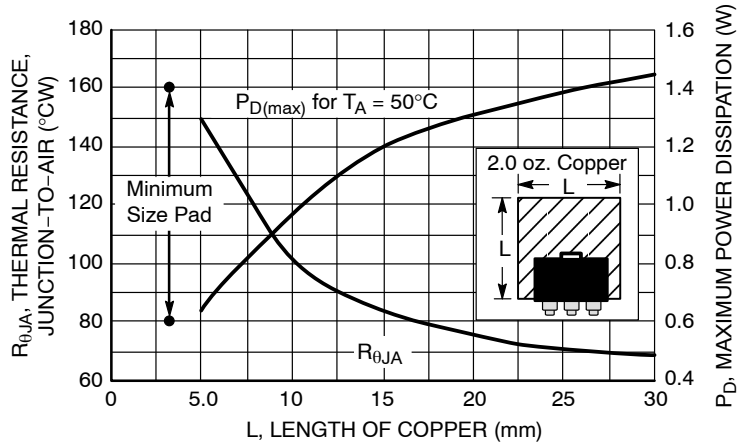

**Figure 17. SOT-223 Thermal Resistance and Maximum Power Dissipation versus P.C.B. Copper Length**

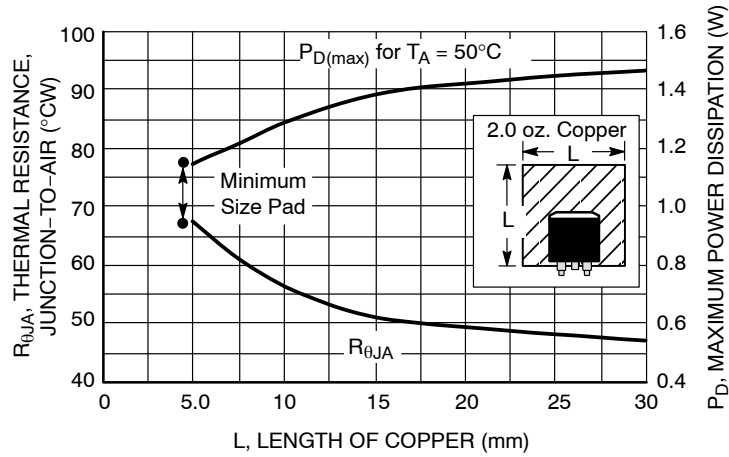

**Figure 18. DPAK Thermal Resistance and Maximum Power Dissipation versus P.C.B. Copper Length**

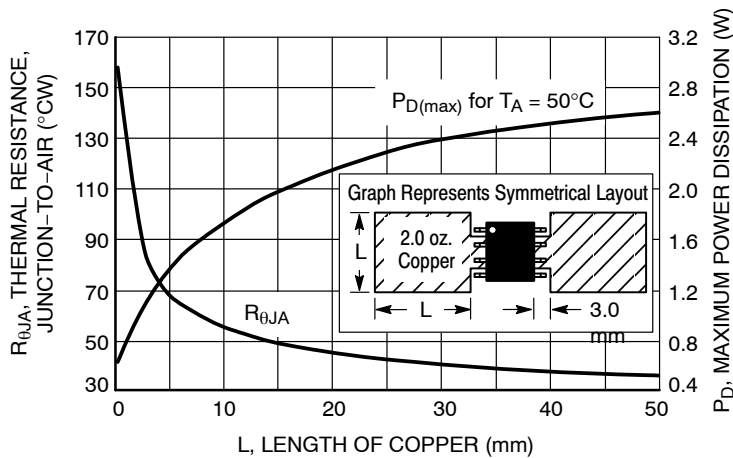

**Figure 19. SOP-8 Thermal Resistance and Maximum Power Dissipation versus P.C.B. Copper Length**

# MC33275, NCV33275

## ORDERING INFORMATION

Device	V <sub>O</sub> Typ (V)	Operating Temperature Range, Tolerance	Case	Package	Marking	Shipping <sup>†</sup>
MC33275D-2.5G	2.5 V (Fixed Voltage)	1% Tolerance at T <sub>A</sub> = 25°C	751	SOIC-8 (Pb-Free)	27525	98 Units/Rail
MC33275D-2.5R2G			751	SOIC-8 (Pb-Free)	27525	2500/Tape & Reel
MC33275DT-2.5G			369A	DPAK (Pb-Free)	27525G	75 Units/Rail
MC33275DT-2.5RKG			369A	DPAK (Pb-Free)	27525G	2500/Tape & Reel
MC33275MN-2.5R2G			488AF	DFN8 (Pb-Free)	27525	3000/Tape & Reel
MC33275ST-2.5T3G			318E	SOT-223 (Pb-Free)	27525	4000/Tape & Reel
MC33275D-3.0G	3.0 V (Fixed Voltage)	2% Tolerance at T <sub>J</sub> from -40°C to +125°C	751	SOIC-8 (Pb-Free)	27530	98 Units/Rail
MC33275D-3.0R2G			751	SOIC-8 (Pb-Free)	27530	2500/Tape & Reel
MC33275DT-3.0G			369A	DPAK (Pb-Free)	27530G	75 Units/Rail
MC33275DT-3.0RKG			369A	DPAK (Pb-Free)	27530G	2500/Tape & Reel
MC33275MN-3.0R2G			488AF	DFN8 (Pb-Free)	27530	3000/Tape & Reel
MC33275ST-3.0T3G			318E	SOT-223 (Pb-Free)	27530	4000/Tape & Reel
MC33275D-3.3G	3.3 V (Fixed Voltage)	1% Tolerance at T <sub>A</sub> = 25°C	751	SOIC-8 (Pb-Free)	27533	98 Units/Rail
MC33275D-3.3R2G			751	SOIC-8 (Pb-Free)	27533	2500/Tape & Reel
MC33275DT-3.3G			369A	DPAK (Pb-Free)	27533G	75 Units/Rail
MC33275DT-3.3RKG		369A	DPAK (Pb-Free)	27533G	2500/Tape & Reel	
MC33275ST-3.3T3G		318E	SOT-223 (Pb-Free)	27533	4000/Tape & Reel	
NCV33275ST3.3T3G*		318E	SOT-223 (Pb-Free)	27533	4000/Tape & Reel	
MC33275MN-3.3R2G		488AF	DFN-8 (Pb-Free)	27330	3000/Tape & Reel	
MC33275D-5.0G	5.0 V (Fixed Voltage)	1% Tolerance at T <sub>A</sub> = 25°C	751	SOIC-8 (Pb-Free)	27550	98 Units/Rail
MC33275D-5.0R2G			751	SOIC-8 (Pb-Free)	27550	2500/Tape & Reel
MC33275DT-5.0G		369A	DPAK (Pb-Free)	27550G	75 Units/Rail	
MC33275DT-5.0RKG		369A	DPAK (Pb-Free)	27550G	2500/Tape & Reel	
MC33275MN-5.0R2G		488AF	DFN-8 (Pb-Free)	27550	3000/Tape & Reel	
MC33275ST-5.0T3G		318E	SOT-223 (Pb-Free)	27550	4000/Tape & Reel	
NCV33275ST-5.0T3G*		318E	SOT-223 (Pb-Free)	27550	4000/Tape & Reel	

<sup>†</sup>For information on tape and reel specifications, including part orientation and tape sizes, please refer to our Tape and Reel Packaging Specifications Brochure, BRD8011/D.

\*NCV Prefix for Automotive and Other Applications Requiring Unique Site and Control Change Requirements; AEC-Q100 Qualified and PPAP Capable

# MC33275, NCV33275

## PACKAGE DIMENSIONS

SOT-223 (TO-261)  
ST SUFFIX  
CASE 318E-04  
ISSUE N

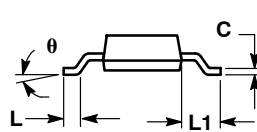
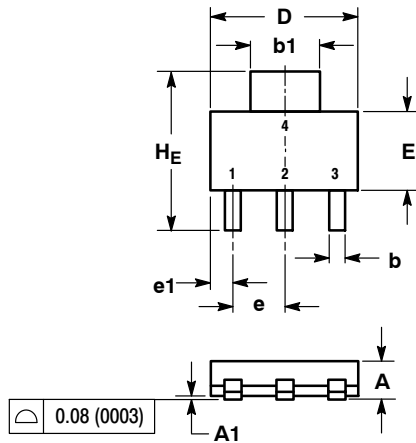

NOTES:

1. DIMENSIONING AND TOLERANCING PER ASME Y14.5M, 1994.
2. CONTROLLING DIMENSION: INCH.

DIM	MILLIMETERS			INCHES		
	MIN	NOM	MAX	MIN	NOM	MAX
A	1.50	1.63	1.75	0.060	0.064	0.068
A1	0.02	0.06	0.10	0.001	0.002	0.004
b	0.60	0.75	0.89	0.024	0.030	0.035
b1	2.90	3.06	3.20	0.115	0.121	0.126
c	0.24	0.29	0.35	0.009	0.012	0.014
D	6.30	6.50	6.70	0.249	0.256	0.263
E	3.30	3.50	3.70	0.130	0.138	0.145
e	2.20	2.30	2.40	0.087	0.091	0.094
e1	0.85	0.94	1.05	0.033	0.037	0.041
L	0.20	---	---	0.008	---	---
L1	1.50	1.75	2.00	0.060	0.069	0.078
HE	6.70	7.00	7.30	0.264	0.276	0.287
θ	0°	---	10°	0°	---	10°

### SOLDERING FOOTPRINT\*

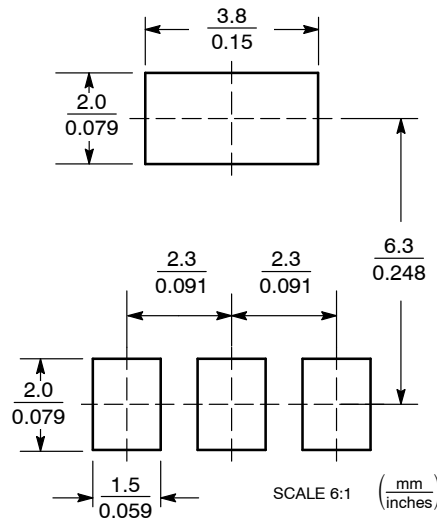

\*For additional information on our Pb-Free strategy and soldering details, please download the ON Semiconductor Soldering and Mounting Techniques Reference Manual, SOLDERRM/D.

# MC33275, NCV33275

## PACKAGE DIMENSIONS

SOIC-8 NB  
D SUFFIX  
CASE 751-07  
ISSUE AK

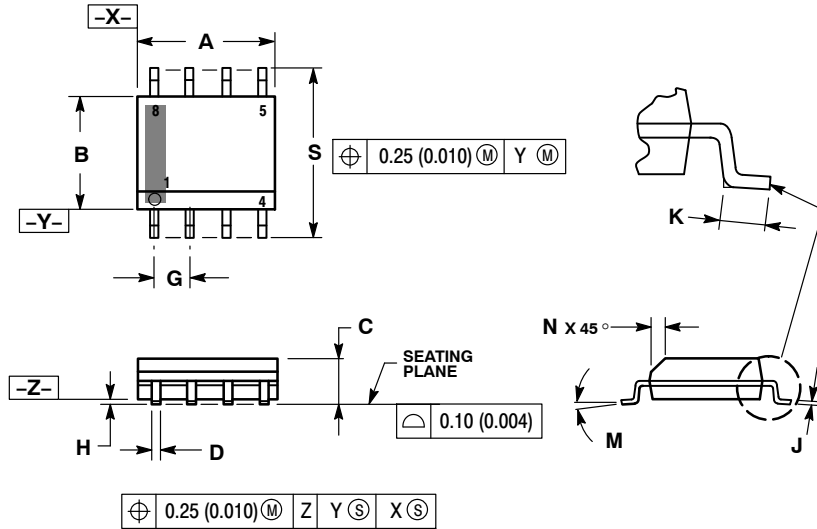

- NOTES:
1. DIMENSIONING AND TOLERANCING PER ANSI Y14.5M, 1982.
  2. CONTROLLING DIMENSION: MILLIMETER.
  3. DIMENSION A AND B DO NOT INCLUDE MOLD PROTRUSION.
  4. MAXIMUM MOLD PROTRUSION 0.15 (0.006) PER SIDE.
  5. DIMENSION D DOES NOT INCLUDE DAMBAR PROTRUSION. ALLOWABLE DAMBAR PROTRUSION SHALL BE 0.127 (0.005) TOTAL IN EXCESS OF THE D DIMENSION AT MAXIMUM MATERIAL CONDITION.
  6. 751-01 THRU 751-06 ARE OBSOLETE. NEW STANDARD IS 751-07.

DIM	MILLIMETERS		INCHES	
	MIN	MAX	MIN	MAX
A	4.80	5.00	0.189	0.197
B	3.80	4.00	0.150	0.157
C	1.35	1.75	0.053	0.069
D	0.33	0.51	0.013	0.020
G	1.27 BSC		0.050 BSC	
H	0.10	0.25	0.004	0.010
J	0.19	0.25	0.007	0.010
K	0.40	1.27	0.016	0.050
M	0°	8°	0°	8°
N	0.25	0.50	0.010	0.020
S	5.80	6.20	0.228	0.244

## SOLDERING FOOTPRINT\*

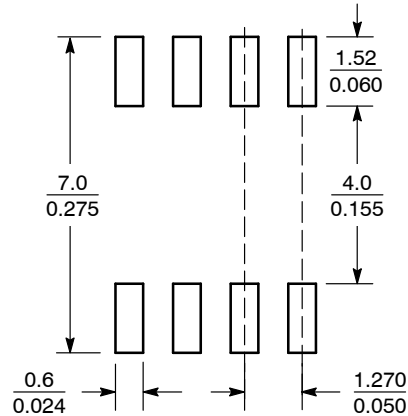

SCALE 6:1 ( $\frac{\text{mm}}{\text{inches}}$ )

\*For additional information on our Pb-Free strategy and soldering details, please download the ON Semiconductor Soldering and Mounting Techniques Reference Manual, SOLDERRM/D.

# MC33275, NCV33275

## PACKAGE DIMENSIONS

**8 PIN DFN, 4x4  
MN SUFFIX  
CASE 488AF  
ISSUE C**

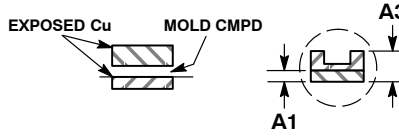
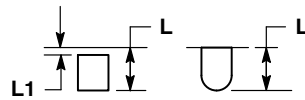
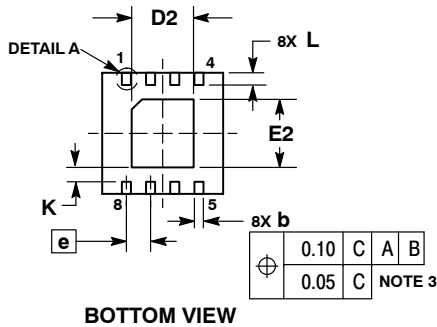
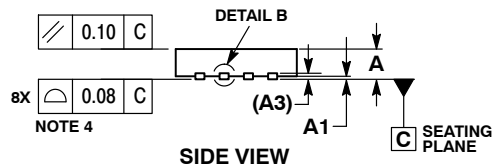
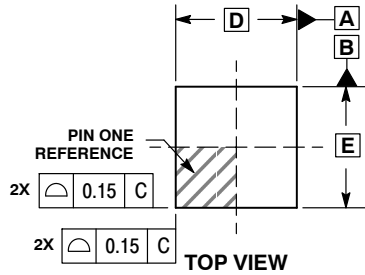

**NOTES:**

1. DIMENSIONS AND TOLERANCING PER ASME Y14.5M, 1994.
2. CONTROLLING DIMENSION: MILLIMETERS.
3. DIMENSION b APPLIES TO PLATED TERMINAL AND IS MEASURED BETWEEN 0.15 AND 0.30MM FROM TERMINAL TIP.
4. COPLANARITY APPLIES TO THE EXPOSED PAD AS WELL AS THE TERMINALS.
5. DETAILS A AND B SHOW OPTIONAL CONSTRUCTIONS FOR TERMINALS.

DIM	MILLIMETERS	
	MIN	MAX
A	0.80	1.00
A1	0.00	0.05
A3	0.20	REF
b	0.25	0.35
D	4.00	BSC
D2	1.91	2.21
E	4.00	BSC
E2	2.09	2.39
e	0.80	BSC
K	0.20	---
L	0.30	0.50
L1	---	0.15

**SOLDERING FOOTPRINT\***

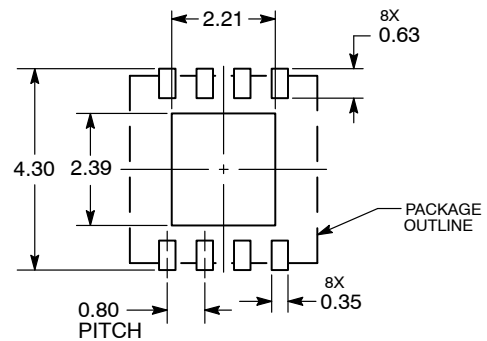

DIMENSIONS: MILLIMETERS

\*For additional information on our Pb-Free strategy and soldering details, please download the ON Semiconductor Soldering and Mounting Techniques Reference Manual, SOLDERRM/D.

# MC33275, NCV33275

## PACKAGE DIMENSIONS

### DPAK (SINGLE GAUGE) CASE 369C ISSUE E

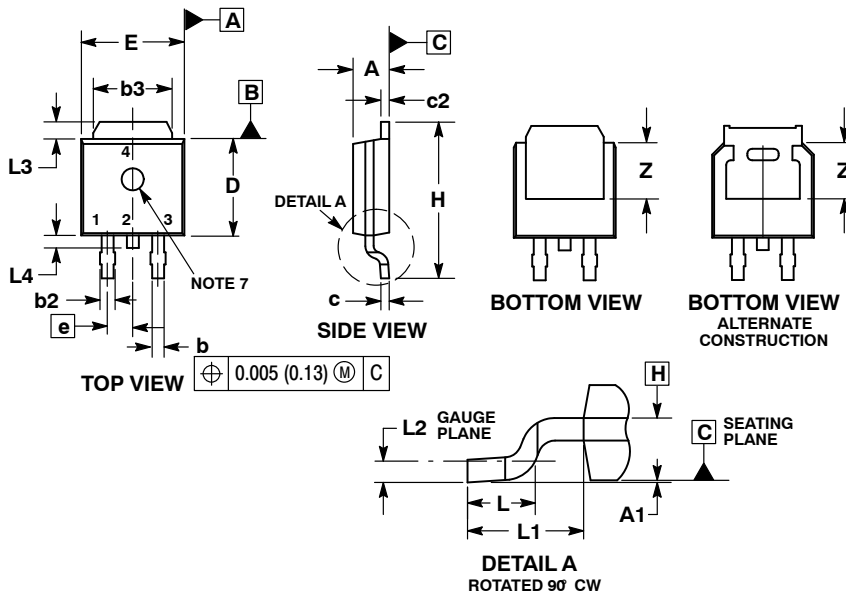

#### NOTES:

1. DIMENSIONING AND TOLERANCING PER ASME Y14.5M, 1994.
2. CONTROLLING DIMENSION: INCHES.
3. THERMAL PAD CONTOUR OPTIONAL WITHIN DIMENSIONS b3, L3 and Z.
4. DIMENSIONS D AND E DO NOT INCLUDE MOLD FLASH, PROTRUSIONS, OR BURRS. MOLD FLASH, PROTRUSIONS, OR GATE BURRS SHALL NOT EXCEED 0.006 INCHES PER SIDE.
5. DIMENSIONS D AND E ARE DETERMINED AT THE OUTERMOST EXTREMES OF THE PLASTIC BODY.
6. DATUMS A AND B ARE DETERMINED AT DATUM PLANE H.
7. OPTIONAL MOLD FEATURE.

DIM	INCHES		MILLIMETERS	
	MIN	MAX	MIN	MAX
A	0.086	0.094	2.18	2.38
A1	0.000	0.005	0.00	0.13
b	0.025	0.035	0.63	0.89
b2	0.028	0.045	0.72	1.14
b3	0.180	0.215	4.57	5.46
c	0.018	0.024	0.46	0.61
c2	0.018	0.024	0.46	0.61
D	0.235	0.245	5.97	6.22
E	0.250	0.265	6.35	6.73
e	0.090 BSC		2.29 BSC	
H	0.370	0.410	9.40	10.41
L	0.055	0.070	1.40	1.78
L1	0.114 REF		2.90 REF	
L2	0.020 BSC		0.51 BSC	
L3	0.035	0.050	0.89	1.27
L4	---	0.040	---	1.01
Z	0.155	---	3.93	---

#### SOLDERING FOOTPRINT\*

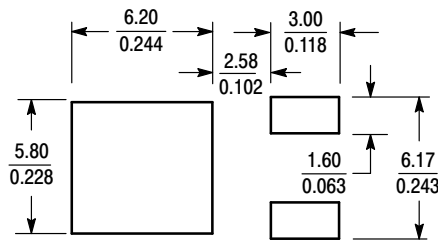

SCALE 3:1  $\left(\frac{\text{mm}}{\text{inches}}\right)$

\*For additional information on our Pb-Free strategy and soldering details, please download the ON Semiconductor Soldering and Mounting Techniques Reference Manual, SOLDERRM/D.

ON Semiconductor and the  are registered trademarks of Semiconductor Components Industries, LLC (SCILLC) or its subsidiaries in the United States and/or other countries. SCILLC owns the rights to a number of patents, trademarks, copyrights, trade secrets, and other intellectual property. A listing of SCILLC's product/patent coverage may be accessed at [www.onsemi.com/site/pdf/Patent-Marketing.pdf](http://www.onsemi.com/site/pdf/Patent-Marketing.pdf). SCILLC reserves the right to make changes without further notice to any products herein. SCILLC makes no warranty, representation or guarantee regarding the suitability of its products for any particular purpose, nor does SCILLC assume any liability arising out of the application or use of any product or circuit, and specifically disclaims any and all liability, including without limitation special, consequential or incidental damages. "Typical" parameters which may be provided in SCILLC data sheets and/or specifications can and do vary in different applications and actual performance may vary over time. All operating parameters, including "Typicals" must be validated for each customer application by customer's technical experts. SCILLC does not convey any license under its patent rights nor the rights of others. SCILLC products are not designed, intended, or authorized for use as components in systems intended for surgical implant into the body, or other applications intended to support or sustain life, or for any other application in which the failure of the SCILLC product could create a situation where personal injury or death may occur. Should Buyer purchase or use SCILLC products for any such unintended or unauthorized application, Buyer shall indemnify and hold SCILLC and its officers, employees, subsidiaries, affiliates, and distributors harmless against all claims, costs, damages, and expenses, and reasonable attorney fees arising out of, directly or indirectly, any claim of personal injury or death associated with such unintended or unauthorized use, even if such claim alleges that SCILLC was negligent regarding the design or manufacture of the part. SCILLC is an Equal Opportunity/Affirmative Action Employer. This literature is subject to all applicable copyright laws and is not for resale in any manner.

#### PUBLICATION ORDERING INFORMATION

##### LITERATURE FULFILLMENT:

Literature Distribution Center for ON Semiconductor  
P.O. Box 5163, Denver, Colorado 80217 USA  
Phone: 303-675-2175 or 800-344-3860 Toll Free USA/Canada  
Fax: 303-675-2176 or 800-344-3867 Toll Free USA/Canada  
Email: [orderlit@onsemi.com](mailto:orderlit@onsemi.com)

**N. American Technical Support:** 800-282-9855 Toll Free  
USA/Canada  
**Europe, Middle East and Africa Technical Support:**  
Phone: 421 33 790 2910  
**Japan Customer Focus Center**  
Phone: 81-3-5817-1050

**ON Semiconductor Website:** [www.onsemi.com](http://www.onsemi.com)

**Order Literature:** <http://www.onsemi.com/orderlit>

For additional information, please contact your local Sales Representative

## Looking for pricing, stock, or lifecycle information?

Click below to explore more details on WIN SOURCE:

 [View MC33275D-3.3R2G on WIN SOURCE](#)

 [ON Semiconductor](#) Information

## Optimize Your Supply Chain with WIN SOURCE Solutions

-  Global Sourcing Solution
-  Obsolete Management
-  Cost Control Management
-  Shortage Management
-  Alternative Solution
-  Excess Inventory Management