



2SD1620

Bipolar Transistor 10V, 3A, Low $V_{CE(sat)}$, NPN Single PCP

ON Semiconductor®
<http://onsemi.com>

Features

- Less power dissipation because of low $V_{CE(sat)}$, permitting more flashes of light to be emitted
- Large current capacity and highly resistant to breakdown
- Excellent linearity of h_{FE} in the region from low current to high current
- Ultrasmall size supports high-density, ultrasmall-sized hybrid IC designs

Specifications

Absolute Maximum Ratings at $T_a=25^\circ\text{C}$

| Parameter | Symbol | Conditions | Ratings | Unit |
|------------------------------|-----------|------------|---------|------|
| Collector-to-Base Voltage | V_{CBO} | | 30 | V |
| Collector-to-Emitter Voltage | V_{CEX} | | 20 | V |
| Collector-to-Emitter Voltage | V_{CEO} | | 10 | V |
| Emitter-to-Base Voltage | V_{EBO} | | 6 | V |
| Collector Current | I_C | | 3 | A |
| Collector Current (Pulse) | I_{CP} | | 5 | A |

Continued on next page.

Package Dimensions

unit : mm (typ)

7007B-004

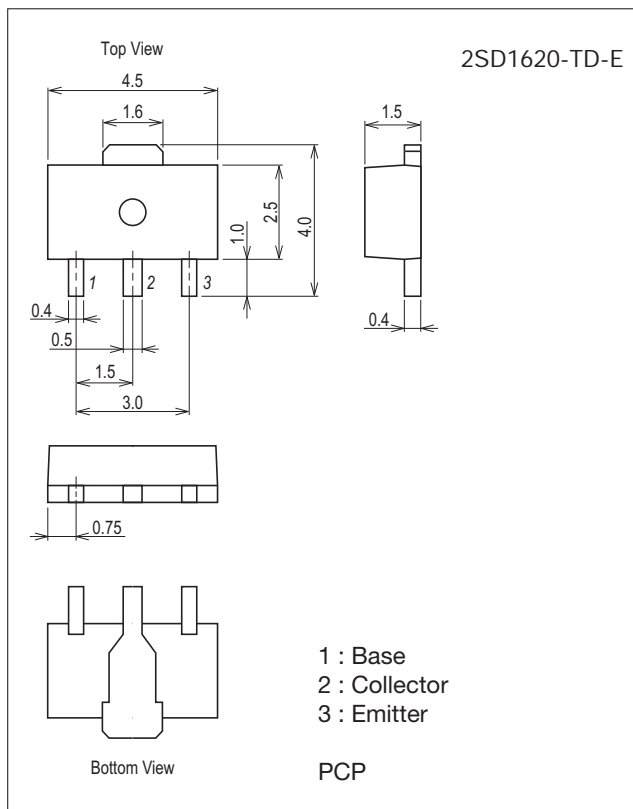

Product & Package Information

- Package : PCP
- JEITA, JEDEC : SC-62, SOT-89, TO-243
- Minimum Packing Quantity : 1,000 pcs./reel

Packing Type: TD

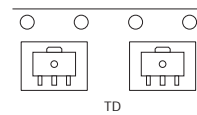

Marking

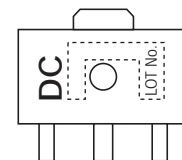

Electrical Connection

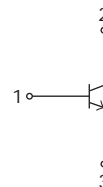

2SD1620

Continued from preceding page.

| Parameter | Symbol | Conditions | Ratings | Unit |
|-----------------------|--------|---|-------------|------|
| Collector Dissipation | Pc | | 500 | mW |
| | | When mounted on ceramic substrate (250mm ² ×0.8mm) | 1.3 | W |
| Junction Temperature | Tj | | 150 | °C |
| Storage Temperature | Tstg | | -55 to +150 | °C |

Stresses exceeding Maximum Ratings may damage the device. Maximum Ratings are stress ratings only. Functional operation above the Recommended Operating Conditions is not implied. Extended exposure to stresses above the Recommended Operating Conditions may affect device reliability.

Electrical Characteristics at Ta=25°C

| Parameter | Symbol | Conditions | Ratings | | | Unit |
|---|----------------------|--|---------|-----|-----|------|
| | | | min | typ | max | |
| Collector Cutoff Current | ICBO | V _{CB} =20V, I _E =0A | | | 100 | nA |
| Emitter Cutoff Current | IEBO | V _{EB} =4V, I _C =0A | | | 100 | nA |
| DC Current Gain | h _{FE} | V _{CE} =2V, I _C =3A | 140 | 210 | | |
| Gain-Bandwidth Product | f _T | V _{CE} =10V, I _C =50mA | | 200 | | MHz |
| Output Capacitance | Cob | V _{CB} =10V, f=1MHz | | 30 | | pF |
| Collector-to-Emitter Saturation Voltage | V _{CE(sat)} | I _C =3A, I _B =60mA | | 0.3 | 0.4 | V |
| Collector-to-Base Breakdown Voltage | V(BR)CBO | I _C =10μA, I _E =0A | 30 | | | V |
| Collector-to-Emitter Breakdown Voltage | V(BR)CEX | I _C =1mA, V _{BE} =3V | 20 | | | V |
| Collector-to-Emitter Breakdown Voltage | V(BR)CEO | I _C =1mA, R _{BE} =∞ | 10 | | | V |
| Emitter-to-Base Breakdown Voltage | V(BR)EBO | I _E =10μA, I _C =0A | 6 | | | V |

Ordering Information

| Device | Package | Shipping | memo |
|--------------|---------|----------------|---------|
| 2SD1620-TD-E | PCP | 1,000pcs./reel | Pb Free |

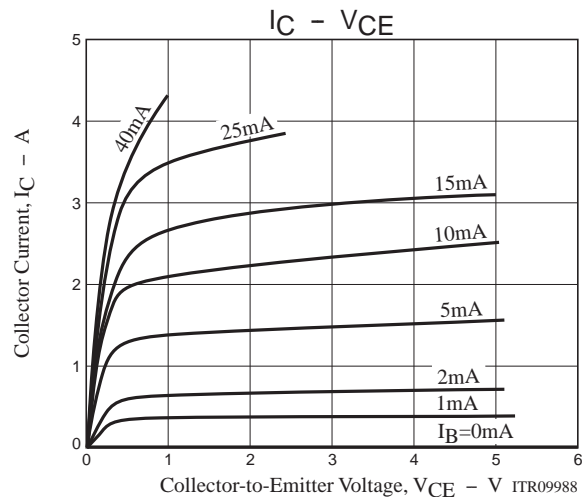
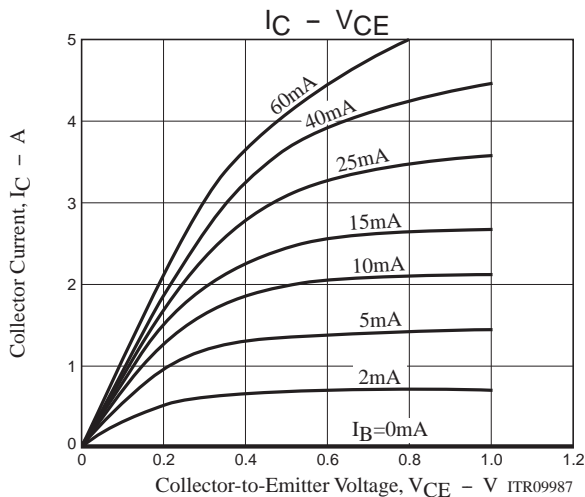

2SD1620

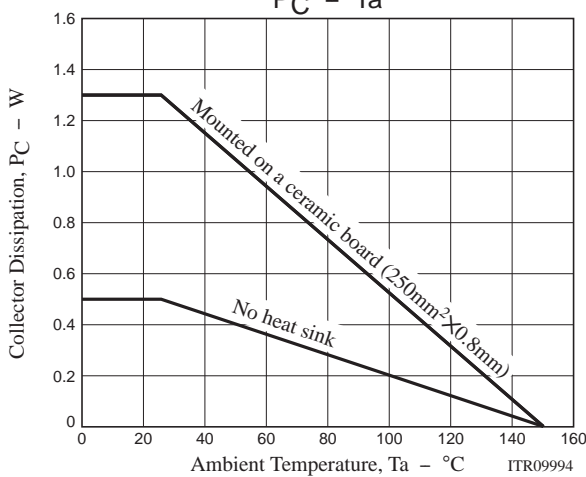
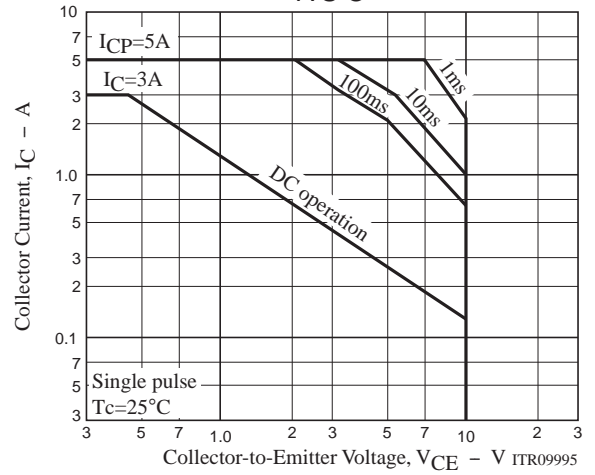
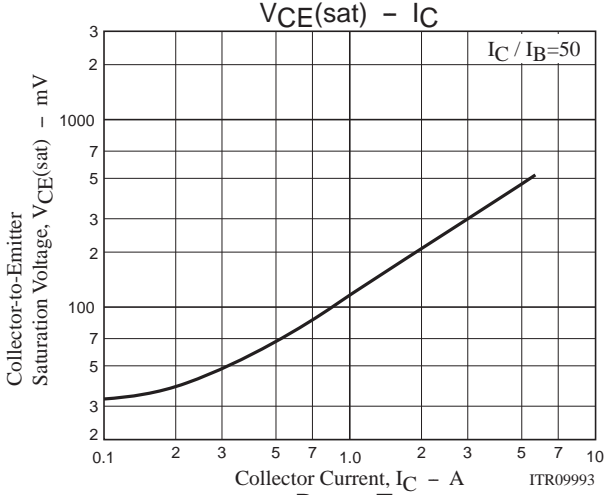
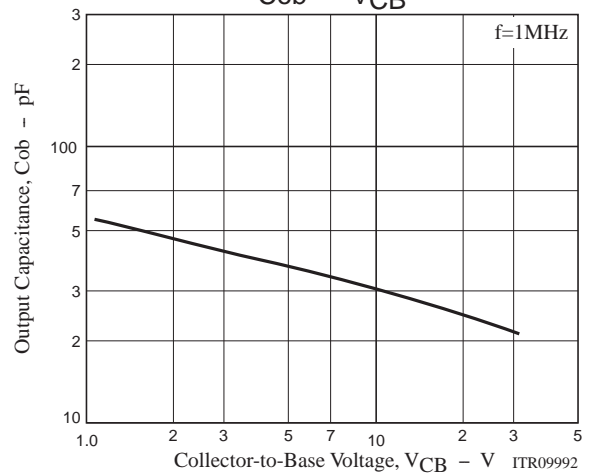
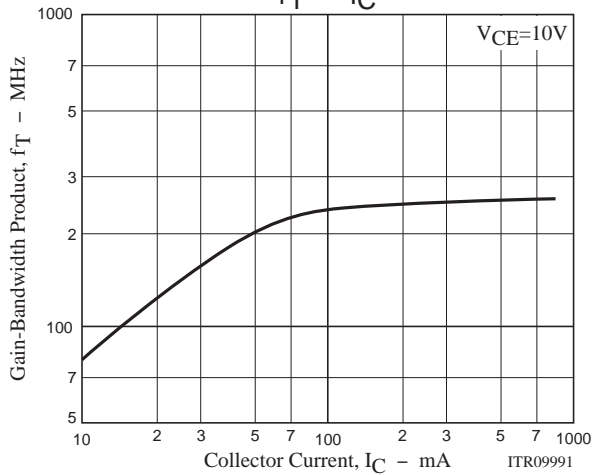
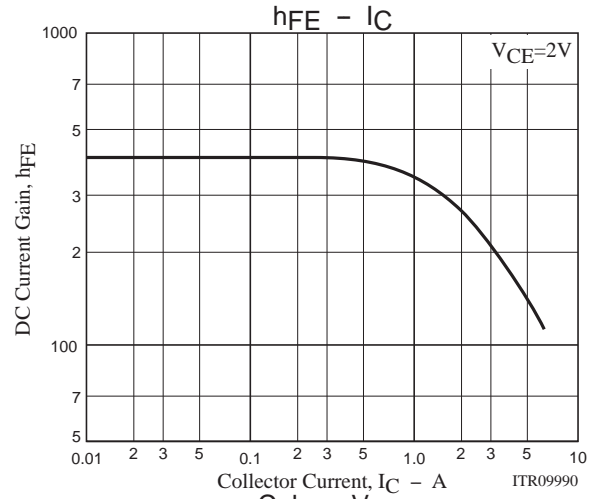
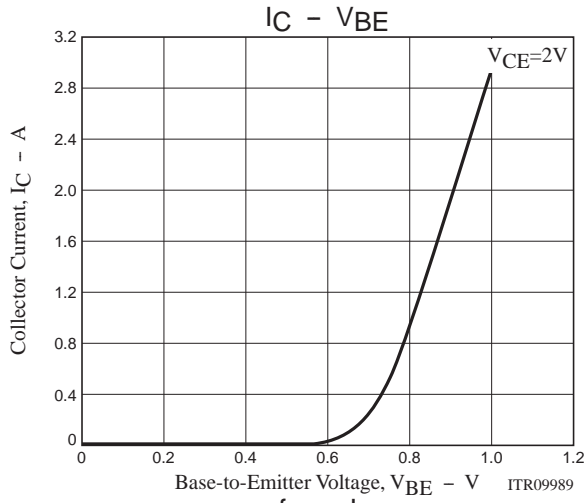

Bag Packing Specification

2SD1620-TD-E

1. Packing Format

| Package Name | Carrier Tape Type | Maximum Number of devices contained (pcs) | | | Packing format | |
|--------------|-------------------|---|-----------|-----------|---|--|
| | | Reel | Inner box | Outer box | Inner BOX (C-1) | Outer BOX (A-7) |
| PCP | PCP | 1,000 | 4,000 | 24,000 | 4 reels contained Dimensions:mm (external) 183×72×185 | 6 inner boxes contained Dimensions:mm (external) 440×195×210 |

Reel label, Inner box label
(unit : mm)

Outer box label
It is a label at the time of factory shipments.
The form of a label may change in physical distribution process.

Packing method

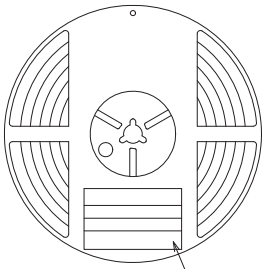

Type No.
LOT No.
Quantity
Origin

Reel label

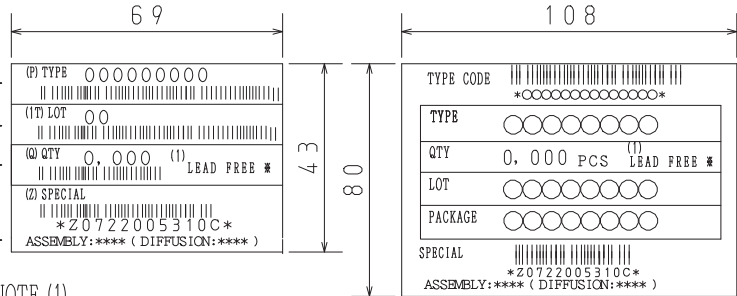

NOTE (1)

The LEAD FREE * description shows that the surface treatment of the terminal is lead free.

| Label | JEITA Phase |
|-------------|----------------|
| LEAD FREE 3 | JEITA Phase 3A |
| LEAD FREE 4 | JEITA Phase 3 |

2. Taping configuration

2-1. Carrier tape size (unit:mm)

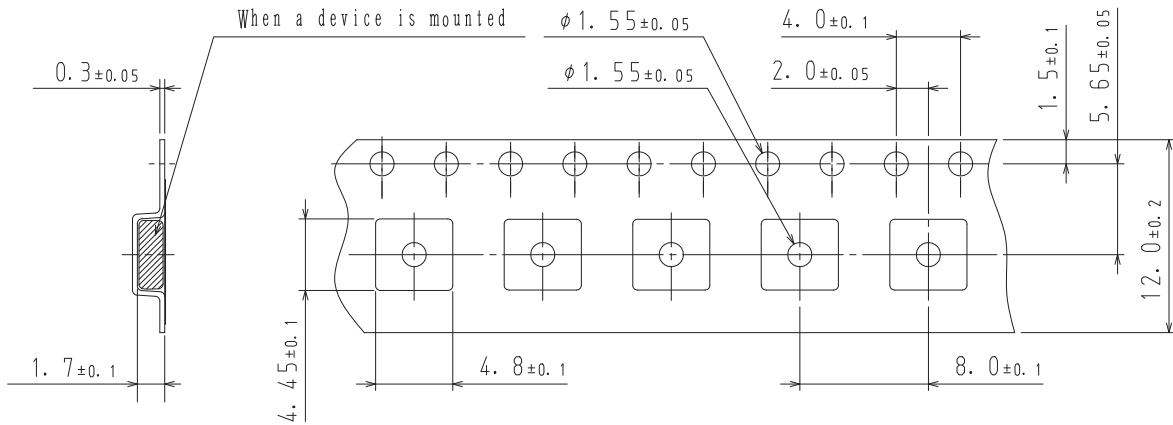

2-2. Device placement direction

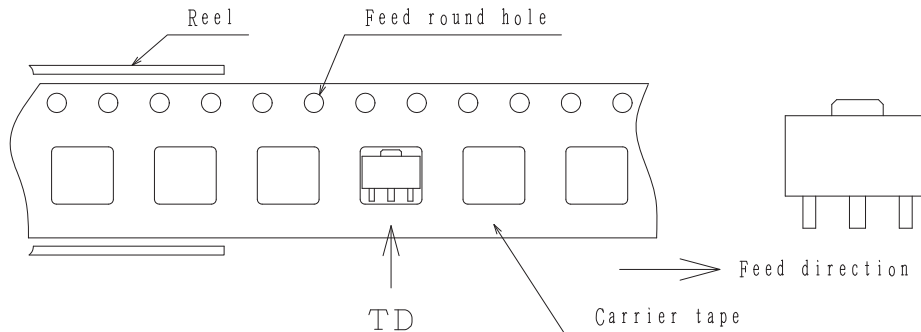

Those with pin 1 index on the feed hole side.....TD

2SD1620

Outline Drawing

2SD1620-TD-E

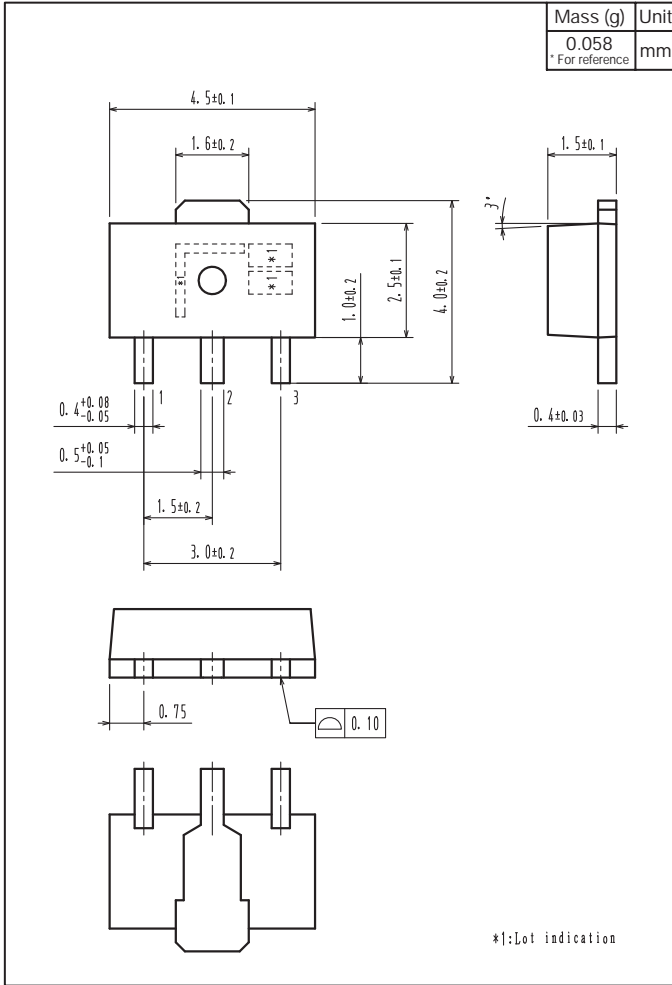

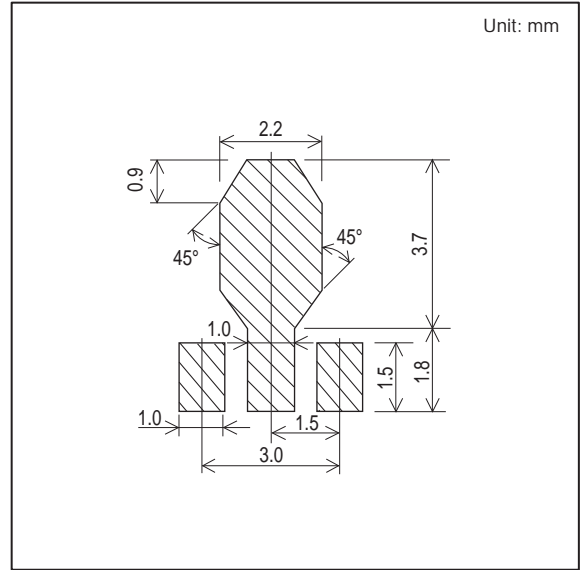

Land Pattern Example



ON Semiconductor and the ON logo are registered trademarks of Semiconductor Components Industries, LLC (SCILLC). SCILLC owns the rights to a number of patents, trademarks, copyrights, trade secrets, and other intellectual property. A listing of SCILLC's product/patent coverage may be accessed at www.onsemi.com/site/pdf/Patent-Marking.pdf. SCILLC reserves the right to make changes without further notice to any products herein. SCILLC makes no warranty, representation or guarantee regarding the suitability of its products for any particular purpose, nor does SCILLC assume any liability arising out of the application or use of any product or circuit, and specifically disclaims any and all liability, including without limitation special, consequential or incidental damages. "Typical" parameters which may be provided in SCILLC data sheets and/or specifications can and do vary in different applications and actual performance may vary over time. All operating parameters, including "Typicals" must be validated for each customer application by customer's technical experts. SCILLC does not convey any license under its patent rights nor the rights of others. SCILLC products are not designed, intended, or authorized for use as components in systems intended for surgical implant into the body, or other applications intended to support or sustain life, or for any other application in which the failure of the SCILLC product could create a situation where personal injury or death may occur. Should Buyer purchase or use SCILLC products for any such unintended or unauthorized application, Buyer shall indemnify and hold SCILLC and its officers, employees, subsidiaries, affiliates, and distributors harmless against all claims, costs, damages, and expenses, and reasonable attorney fees arising out of, directly or indirectly, any claim of personal injury or death associated with such unintended or unauthorized use, even if such claim alleges that SCILLC was negligent regarding the design or manufacture of the part. SCILLC is an Equal Opportunity/Affirmative Action Employer. This literature is subject to all applicable copyright laws and is not for resale in any manner.

Looking for pricing, stock, or lifecycle information?

Click below to explore more details on WIN SOURCE:

-  [View 2SD1620-TD-E on WIN SOURCE](#)
-  [ON Semiconductor](#) Information

Optimize Your Supply Chain with WIN SOURCE Solutions

-  Global Sourcing Solution
-  Obsolete Management
-  Cost Control Management
-  Shortage Management
-  Alternative Solution
-  Excess Inventory Management