



**THE DATASHEET OF
2SD1767T100R**



Medium power transistor (80V, 0.7A)

2SD1767 / 2SD1859

●Features

- 1) High breakdown voltage, $BV_{CEO}=80V$, and high current, $I_C=0.7A$.
- 2) Complements the 2SB1189 / 2SB1238.

●Absolute maximum ratings (Ta=25°C)

Parameter	Symbol	Limits	Unit
Collector-base voltage	V_{CBO}	80	V
Collector-emitter voltage	V_{CEO}	80	V
Emitter-base voltage	V_{EBO}	5	V
Collector current	I_C	0.7	A(DC)
	I_{CP}	1	A(Pulse) *1
Collector power dissipation	Pc	0.5	W
		2 *2	
		1 *3	
Junction temperature	Tj	150	°C
Storage temperature	Tstg	-55 to +150	°C

*1 Pw=10ms, duty=1/2

*2 When mounted on a 40×40×0.7 mm ceramic board.

*3 Printed circuit board 1.7 mm thick, collector plating 1cm² or larger.

●Packaging specifications and hFE

Type	2SD1767	2SD1859
Package	MPT3	ATV
hFE	PQR	QR
Marking	DC*	-
Code	T100	TV2
Basic ordering unit (pieces)	1000	2500

*Denotes hFE

●External dimensions (Unit : mm)

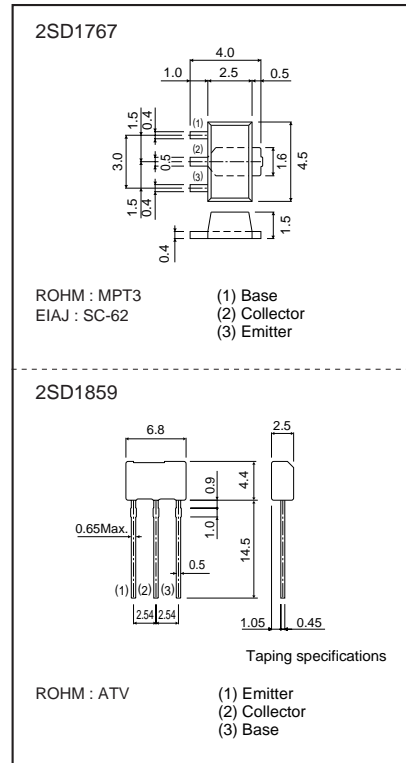

●Electrical characteristics (Ta=25°C)

Parameter	Symbol	Min.	Typ.	Max.	Unit	Conditions
Collector-base breakdown voltage	BV_{CBO}	80	-	-	V	$I_C=50\mu A$
Collector-emitter breakdown voltage	BV_{CEO}	80	-	-	V	$I_C=2mA$
Emitter-base breakdown voltage	BV_{EBO}	5	-	-	V	$I_E=50\mu A$
Collector cutoff current	I_{CBO}	-	-	0.5	μA	$V_{CB}=50V$
Emitter cutoff current	I_{EBO}	-	-	0.5	μA	$V_{EB}=4V$
Collector-emitter saturation voltage	$V_{CE(sat)}$	-	0.2	0.4	V	$I_C/I_E=500mA/50mA$
DC current transfer ratio	hFE	120	-	390	-	$V_{CE}/I_C=3V/0.1A$
Transition frequency	fr	-	120	-	MHz	$V_{CE}=10V, I_E=50mA, f=100MHz$
Output capacitance	Cob	-	10	-	pF	$V_{CB}=10V, I_E=0A, f=1MHz$

Transistors

●Electrical characteristics curves

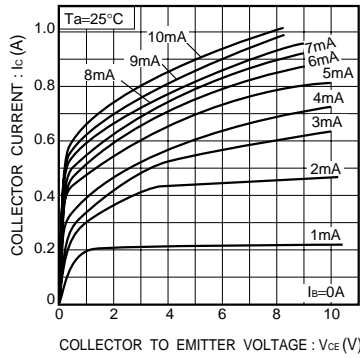

Fig.1 Ground emitter output characteristics

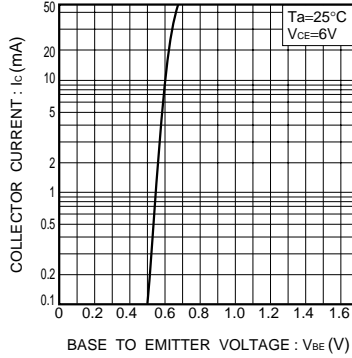

Fig.2 Ground emitter propagation characteristics

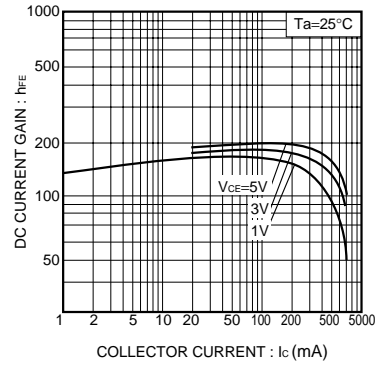

Fig.3 DC current gain vs. collector current

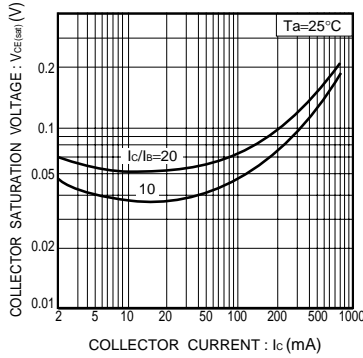

Fig.4 Collector-emitter saturation voltage vs. collector current

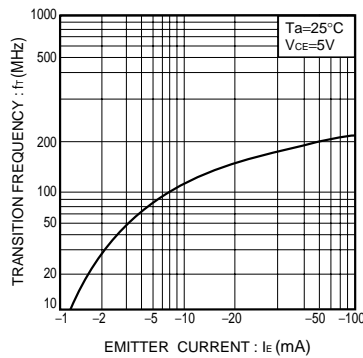

Fig.5 Resistance ratio vs. emitter current

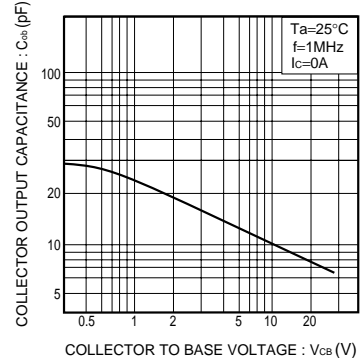

Fig.6 Collector output capacitance vs. collector-base voltage

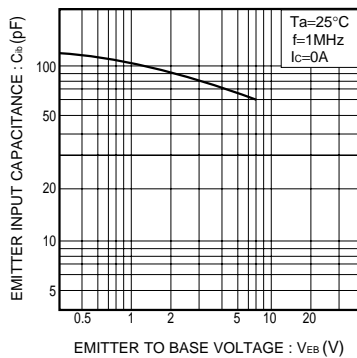

Fig.7 Emitter input capacitance vs. emitter-base voltage

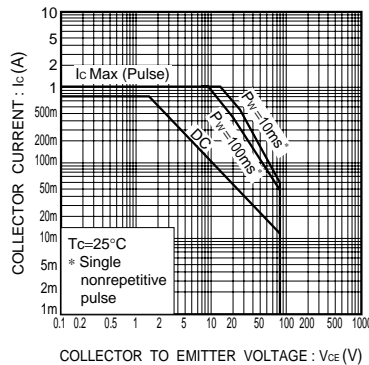

Fig.8 Safe operating area (2SD1859)

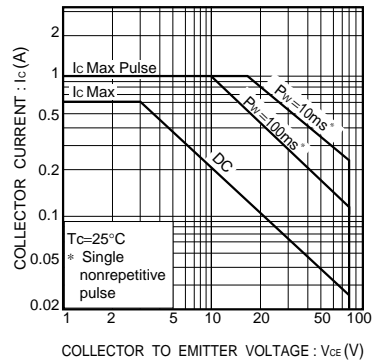

Fig.9 Safe operating area (2SD1767)

Notes

- No technical content pages of this document may be reproduced in any form or transmitted by any means without prior permission of ROHM CO.,LTD.
- The contents described herein are subject to change without notice. The specifications for the product described in this document are for reference only. Upon actual use, therefore, please request that specifications to be separately delivered.
- Application circuit diagrams and circuit constants contained herein are shown as examples of standard use and operation. Please pay careful attention to the peripheral conditions when designing circuits and deciding upon circuit constants in the set.
- Any data, including, but not limited to application circuit diagrams information, described herein are intended only as illustrations of such devices and not as the specifications for such devices. ROHM CO.,LTD. disclaims any warranty that any use of such devices shall be free from infringement of any third party's intellectual property rights or other proprietary rights, and further, assumes no liability of whatsoever nature in the event of any such infringement, or arising from or connected with or related to the use of such devices.
- Upon the sale of any such devices, other than for buyer's right to use such devices itself, resell or otherwise dispose of the same, no express or implied right or license to practice or commercially exploit any intellectual property rights or other proprietary rights owned or controlled by
- ROHM CO., LTD. is granted to any such buyer.
- Products listed in this document are no antiradiation design.

The products listed in this document are designed to be used with ordinary electronic equipment or devices (such as audio visual equipment, office-automation equipment, communications devices, electrical appliances and electronic toys).

Should you intend to use these products with equipment or devices which require an extremely high level of reliability and the malfunction of which would directly endanger human life (such as medical instruments, transportation equipment, aerospace machinery, nuclear-reactor controllers, fuel controllers and other safety devices), please be sure to consult with our sales representative in advance.



About Export Control Order in Japan

Products described herein are the objects of controlled goods in Annex 1 (Item 16) of Export Trade Control Order in Japan.

In case of export from Japan, please confirm if it applies to "objective" criteria or an "informed" (by MITI clause) on the basis of "catch all controls for Non-Proliferation of Weapons of Mass Destruction.

Looking for pricing, stock, or lifecycle information?

Click below to explore more details on WIN SOURCE:

-  [View 2SD1767T100R on WIN SOURCE](#)
-  [Rohm Semiconductor](#) Information

Optimize Your Supply Chain with WIN SOURCE Solutions

-  Global Sourcing Solution
-  Obsolete Management
-  Cost Control Management
-  Shortage Management
-  Alternative Solution
-  Excess Inventory Management