



THE DATASHEET OF
MI1812K121R-00





Medium Current Ferrite Chip Beads

Steward's surface mount ferrite chips provide compact, cost effective EMI filtering for densely packed PCB designs. The small footprint enables placement very close to troublesome high frequency devices. Our proprietary SMT construction yields rugged components with superior impedance vs. frequency characteristics.

Features:

- Small footprint • Excellent retention under Bias • Rugged, monolithic construction • Superior impedance vs. frequency characteristics
- Economical • Broad range of sizes (from 0603 up to 1812) • Broad range of impedance values and current ratings

Applications:

- Filtering of power input pins and devices using high speed clocks • Filtering of low frequency input/output signals of shielded enclosures
- High frequency filtering of medium speed clocks and video signals • Preventing oscillations in high frequency amplifiers
- Data bus filtration • Discrete component filtration in power supplies

Test Specifications:

- Maximum current ratings are determined by testing to a maximum temperature rise of 40° C with continuous operating current
 - Board level components are rated up to a maximum of 75 volts
- Tested with:** • HP4396A (100KHz - 1.8 GHz) or HP8753 (to 6 GHz) Network/Spectrum Analyzer • HP43961A Impedance Test Kit • HP16192A Test Fixture or Inter-Continental Microwave custom fixtures • HP16200A DC Bias Adapter • Philips PM2811 DC Power Supply • Ambient Temperature 23.5°C ± 2° • Bandwidth 3 kHz • Sweep Time 423 ms • Impedance is rated at ± 25% @ 100MHz

PART NUMBERING SYSTEM					
<u>MI</u>	<u>0603</u>	<u>K</u>	<u>300</u>	<u>R</u>	<u>- 00</u>
PRODUCT SERIES CODE	PART SIZE CODE	RATED CURRENT CODE	IMPEDANCE VALUE CODE	PACKAGING CODE	ADDITIONAL PART DESCRIPTION

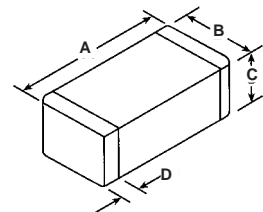

Ambient Operating Temperature Range: -55° C to +125° C

PART NUMBER	A mm (inches)	B mm (inches)	C mm (inches)	D mm (inches)	IMPEDANCE (Z) TYPICAL OHMS @			DCR MAX OHMS	RATED I MAX (continuous) mA
					100MHz	500MHz	1GHz		
MI0603K300R-00	1.60 ± 0.15 (0.063 ± 0.006)	0.80 ± 0.15 (0.031 ± 0.006)	0.80 ± 0.15 (0.031 ± 0.006)	0.36 ± 0.15 (0.014 ± 0.006)	30	41	43	0.090	1,500
MI0603J600R-00	1.60 ± 0.15 (0.063 ± 0.006)	0.80 ± 0.15 (0.031 ± 0.006)	0.80 ± 0.15 (0.031 ± 0.006)	0.36 ± 0.15 (0.014 ± 0.006)	60	92	103	0.100	1,000
MI0603J680R-00	1.60 ± 0.15 (0.063 ± 0.006)	0.80 ± 0.15 (0.031 ± 0.006)	0.80 ± 0.15 (0.031 ± 0.006)	0.36 ± 0.15 (0.014 ± 0.006)	68	106	99	0.100	1,000
* MI0805J070R-00	2.00 ± 0.20 (0.079 ± 0.008)	1.25 ± 0.20 (0.049 ± 0.008)	0.90 ± 0.20 (0.035 ± 0.008)	0.51 ± 0.25 (0.020 ± 0.010)	7	23	28	0.100	1,000
MI0805K110R-00	2.00 ± 0.20 (0.079 ± 0.008)	1.25 ± 0.20 (0.049 ± 0.008)	0.90 ± 0.20 (0.035 ± 0.008)	0.51 ± 0.25 (0.020 ± 0.010)	11	18	19	0.060	1,500
MI0805K170R-00	2.00 ± 0.20 (0.079 ± 0.008)	1.25 ± 0.20 (0.049 ± 0.008)	0.90 ± 0.20 (0.035 ± 0.008)	0.51 ± 0.25 (0.020 ± 0.010)	17	24	24	0.060	1,500
MI0805K260R-00	2.00 ± 0.20 (0.079 ± 0.008)	1.25 ± 0.20 (0.049 ± 0.008)	0.90 ± 0.20 (0.035 ± 0.008)	0.51 ± 0.25 (0.020 ± 0.010)	26	43	45	0.060	1,500
MI0805K320R-00	2.00 ± 0.20 (0.079 ± 0.008)	1.25 ± 0.20 (0.049 ± 0.008)	0.90 ± 0.20 (0.035 ± 0.008)	0.51 ± 0.25 (0.020 ± 0.010)	32	51	51	0.060	1,500
MI0805K400R-00	2.00 ± 0.20 (0.079 ± 0.008)	1.25 ± 0.20 (0.049 ± 0.008)	0.90 ± 0.20 (0.035 ± 0.008)	0.51 ± 0.25 (0.020 ± 0.010)	40	60	63	0.050	1,500
MI1206K260R-00	3.20 ± 0.20 (0.126 ± 0.008)	1.60 ± 0.20 (0.063 ± 0.008)	1.10 ± 0.20 (0.043 ± 0.008)	0.51 ± 0.25 (0.020 ± 0.010)	26	38	40	0.060	1,500
MI1206K310R-00	3.20 ± 0.20 (0.126 ± 0.008)	1.60 ± 0.20 (0.063 ± 0.008)	1.10 ± 0.20 (0.043 ± 0.008)	0.51 ± 0.25 (0.020 ± 0.010)	31	45	50	0.080	1,500
MI1206J700R-00	3.20 ± 0.20 (0.126 ± 0.008)	1.60 ± 0.20 (0.063 ± 0.008)	1.10 ± 0.20 (0.043 ± 0.008)	0.51 ± 0.25 (0.020 ± 0.010)	70	104	107	0.100	1,000
MI1206K900R-00	3.20 ± 0.20 (0.126 ± 0.008)	1.60 ± 0.20 (0.063 ± 0.008)	1.10 ± 0.20 (0.043 ± 0.008)	0.51 ± 0.25 (0.020 ± 0.010)	90	142	158	0.080	1,500

PART NUMBER	A mm (inches)	B mm (inches)	C mm (inches)	D mm (inches)	IMPEDANCE (Z) TYPICAL OHMS @			DCR MAX OHMS	RATED I MAX (continuous) mA
					100MHz	500MHz	1GHz		
MI1206K101R-00	3.20 ± 0.20 (0.126 ± 0.008)	1.60 ± 0.20 (0.063 ± 0.008)	1.10 ± 0.20 (0.043 ± 0.008)	0.51 ± 0.25 (0.020 ± 0.010)	100	146	152	0.075	1,500
MI1206L501R-00	3.20 ± 0.20 (0.126 ± 0.008)	1.60 ± 0.20 (0.063 ± 0.008)	1.10 ± 0.20 (0.043 ± 0.008)	0.51 ± 0.25 (0.020 ± 0.010)	500	150	82	0.060	2,000
MI1806J800R-00	4.50 ± 0.25 (0.177 ± 0.010)	1.60 ± 0.25 (0.063 ± 0.010)	1.60 ± 0.25 (0.063 ± 0.010)	0.51 ± 0.25 (0.020 ± 0.010)	80	129	131	0.150	1,000
MI1812K121R-00	4.50 ± 0.25 (0.177 ± 0.010)	3.20 ± 0.25 (0.126 ± 0.010)	1.40 ± 0.25 (0.055 ± 0.010)	0.51 ± 0.25 (0.020 ± 0.010)	120	198	213	0.060	1,500

* See Steward web site at www.steward.com for the most recent performance curves

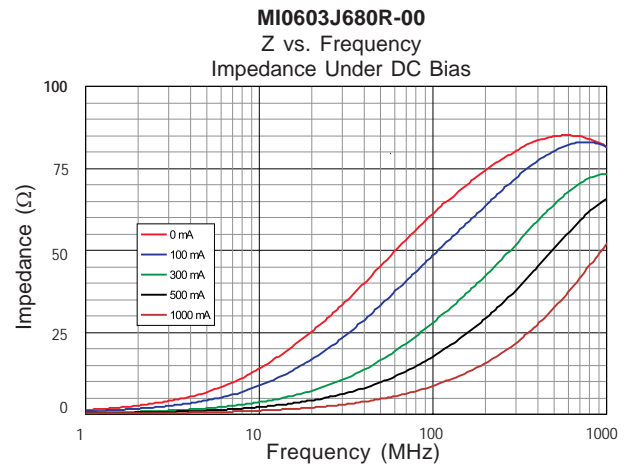
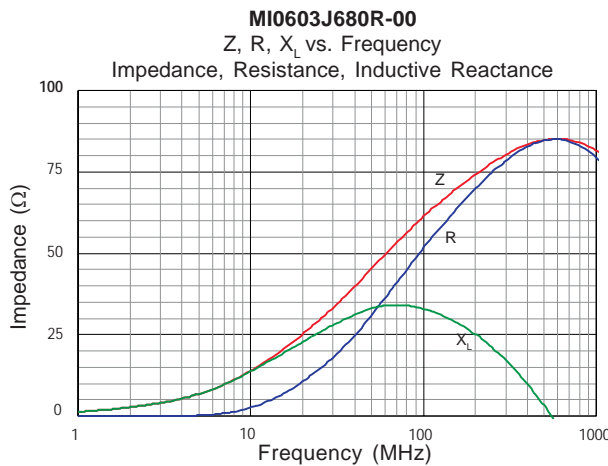
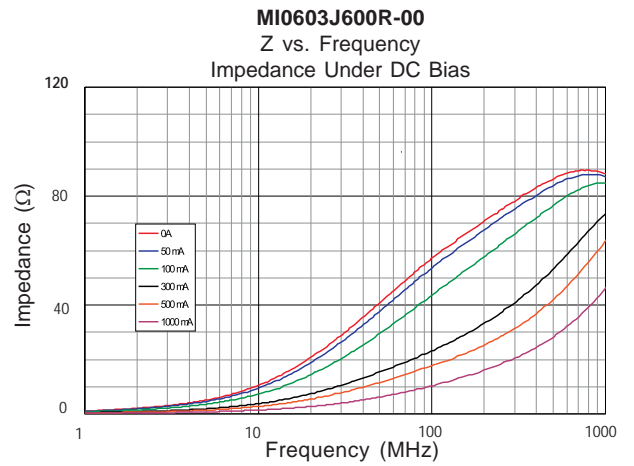
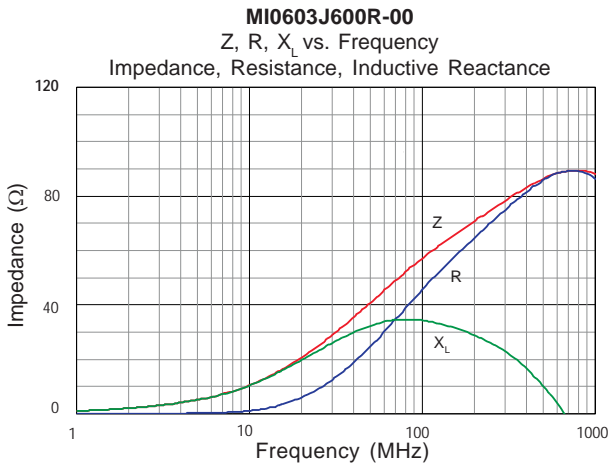
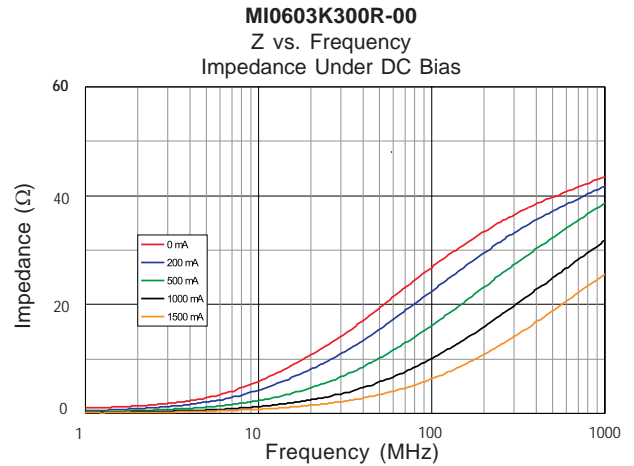
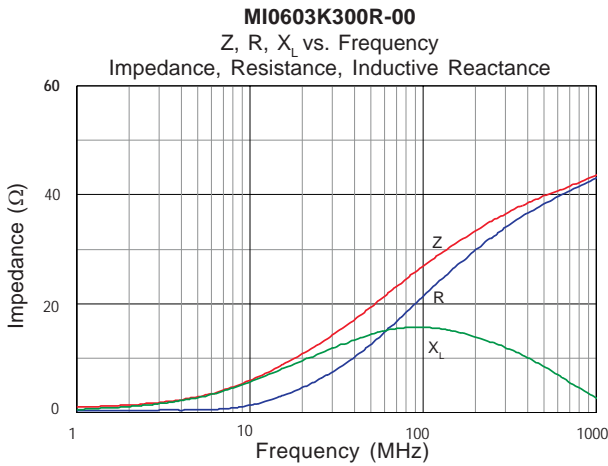

MI0805K110R-00

Z, R, X_L vs. Frequency
Impedance, Resistance, Inductive Reactance

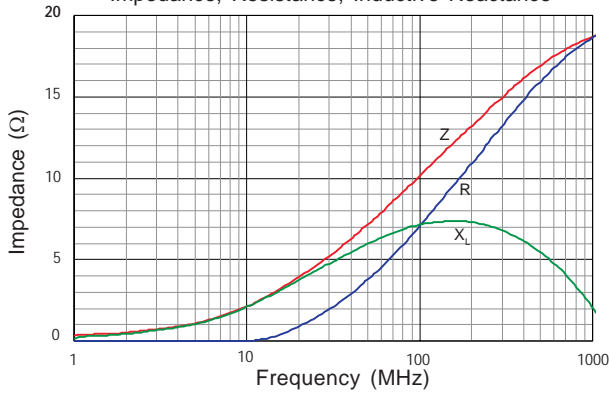

MI0805K110R-00

Z vs. Frequency
Impedance Under DC Bias

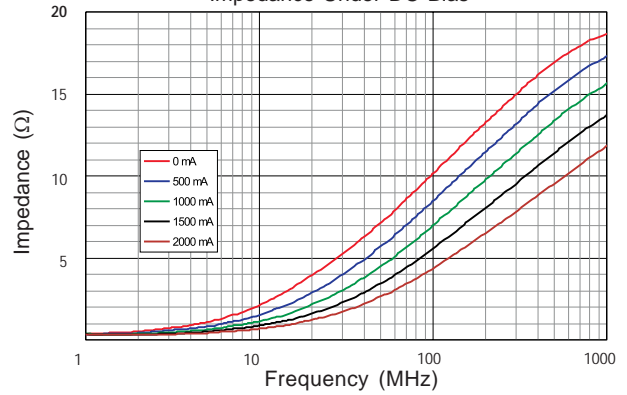

MI0805J170R-00

Z, R, X_L vs. Frequency
Impedance, Resistance, Inductive Reactance

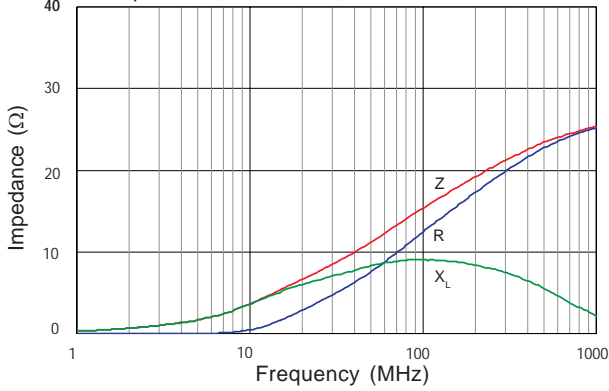

MI0805J170R-00

Z vs. Frequency
Impedance Under DC Bias

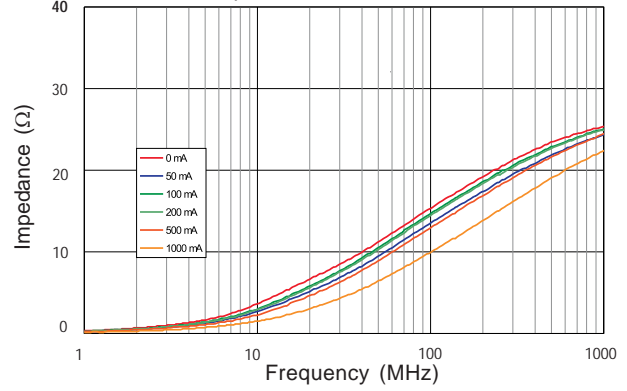

MI0805K260R-00

Z, R, X_L vs. Frequency
Impedance, Resistance, Inductive Reactance

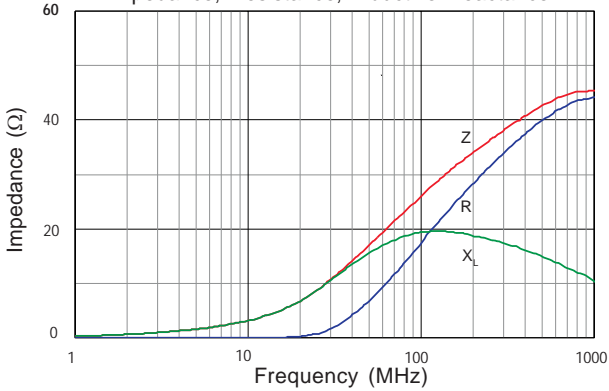

MI0805K260R-00

Z vs. Frequency
Impedance Under DC Bias

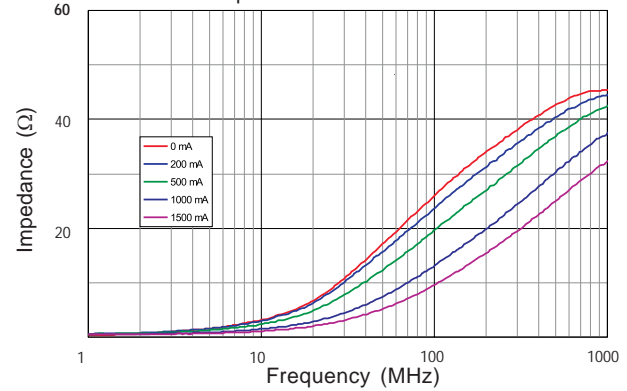

MI0805K320R-00

Z, R, X_L vs. Frequency
Impedance, Resistance, Inductive Reactance

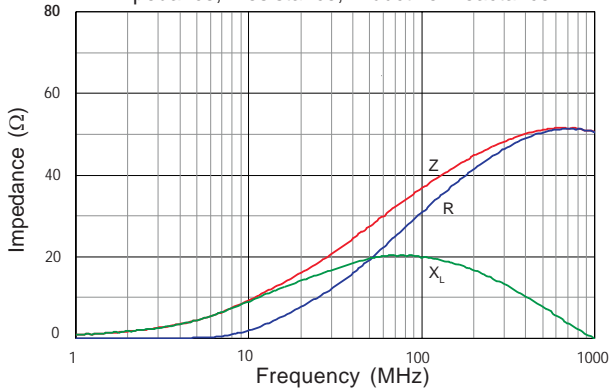

MI0805K320R-00

Z vs. Frequency
Impedance Under DC Bias

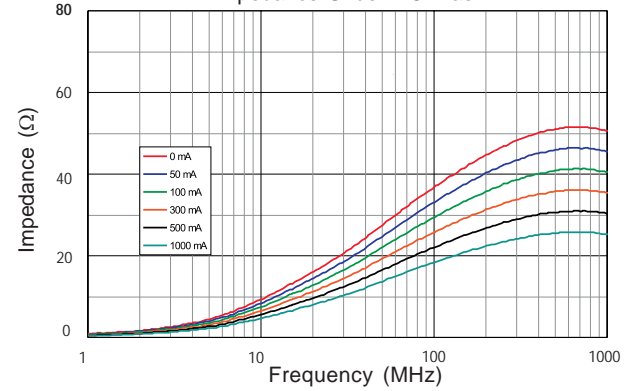

MI0805K400R-00

Z, R, X_L vs. Frequency
Impedance, Resistance, Inductive Reactance

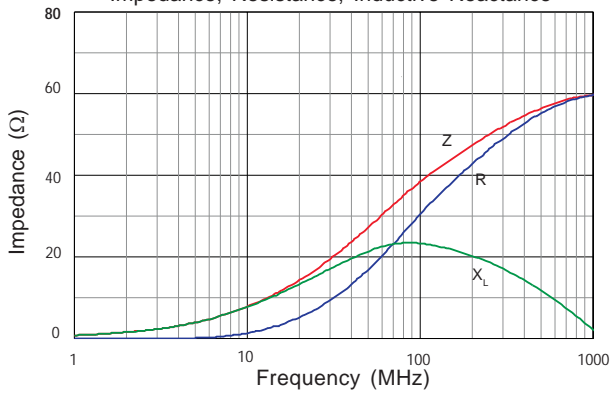

MI0805K400R-00

Z vs. Frequency
Impedance Under DC Bias

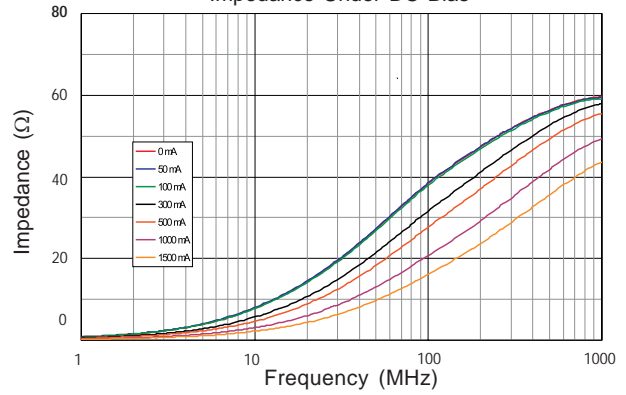

MI1206K260R-00

Z, R, X_L vs. Frequency
Impedance, Resistance, Inductive Reactance

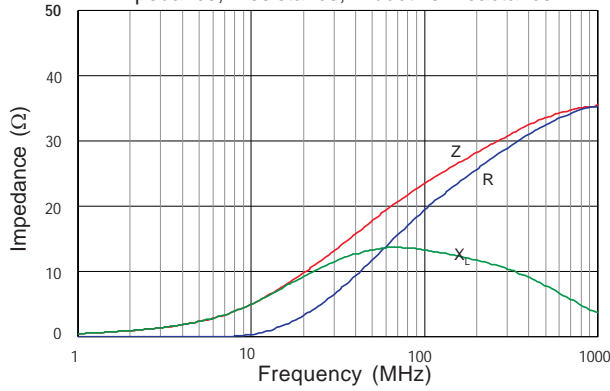

MI1206K260R-00

Z vs. Frequency
Impedance Under DC Bias

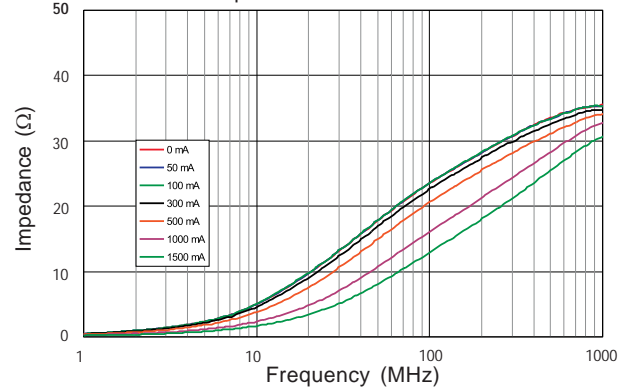

MI1206K310R-00

Z, R, X_L vs. Frequency
Impedance, Resistance, Inductive Reactance

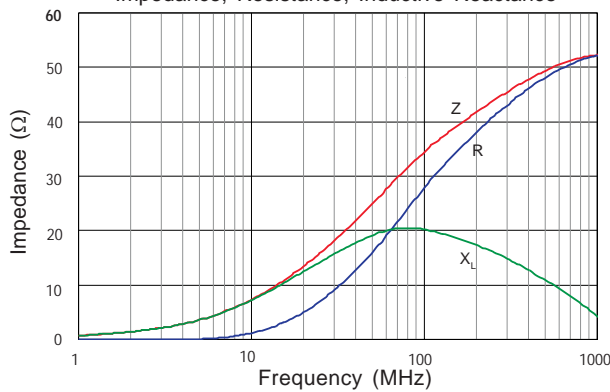

MI1206K310R-00

Z vs. Frequency
Impedance Under DC Bias

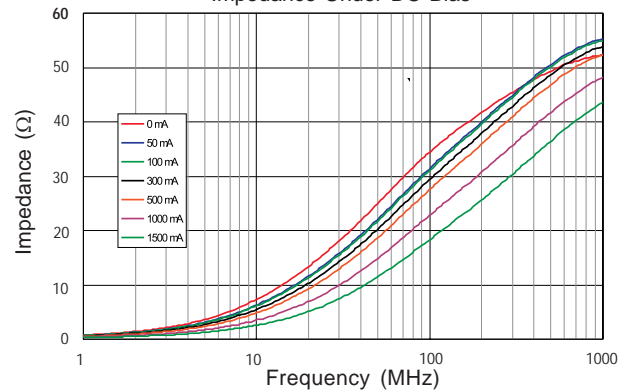

MI1206J700R-00

Z, R, X_L vs. Frequency
Impedance, Resistance, Inductive Reactance

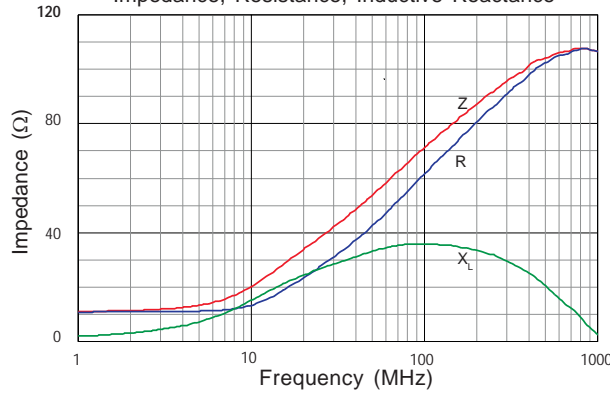

MI1206J700R-00

Z vs. Frequency
Impedance Under DC Bias

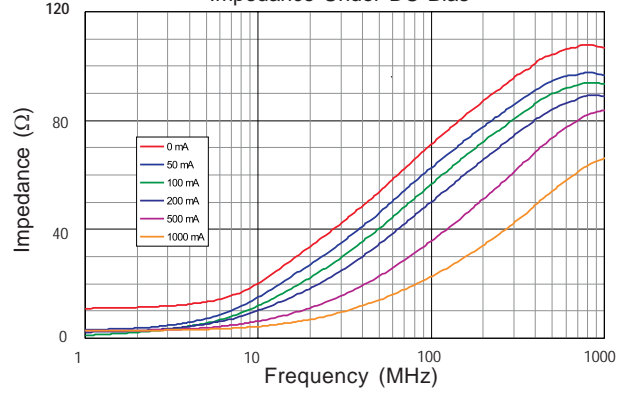

MI1206K900R-00

Z, R, X_L vs. Frequency
Impedance, Resistance, Inductive Reactance

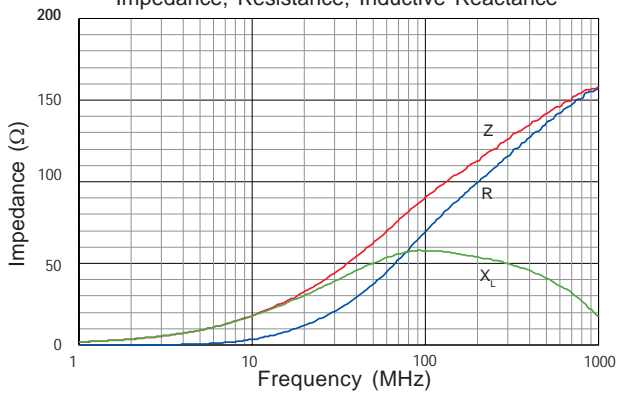

MI1206K900R-00

Z vs. Frequency
Impedance Under DC Bias

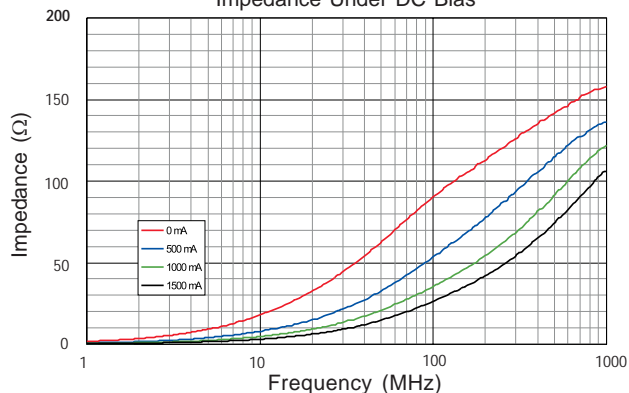

MI1206K101R-00

Z, R, X_L vs. Frequency
Impedance, Resistance, Inductive Reactance

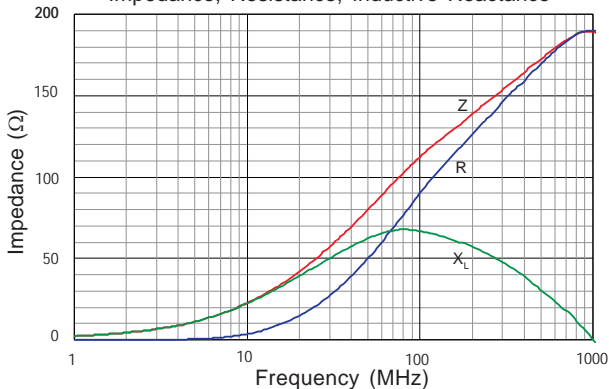

MI1206K101R-00

Z vs. Frequency
Impedance Under DC Bias

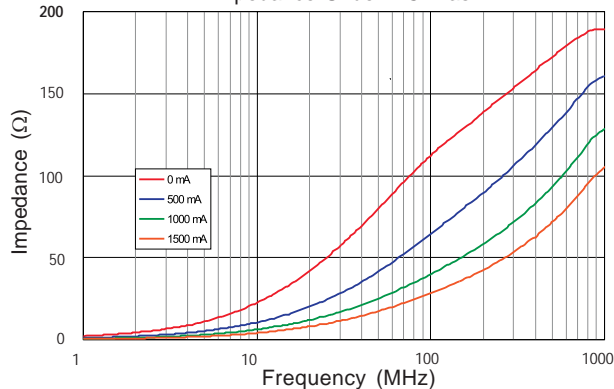

MI1206L501R-00

Z, R, X_L vs. Frequency
Impedance, Resistance, Inductive Reactance

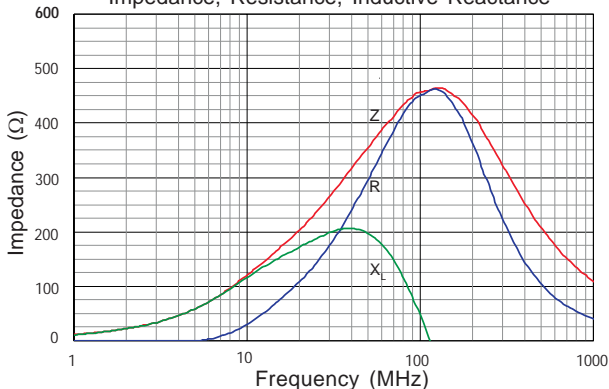

MI1206L501R-00

Z vs. Frequency
Impedance Under DC Bias

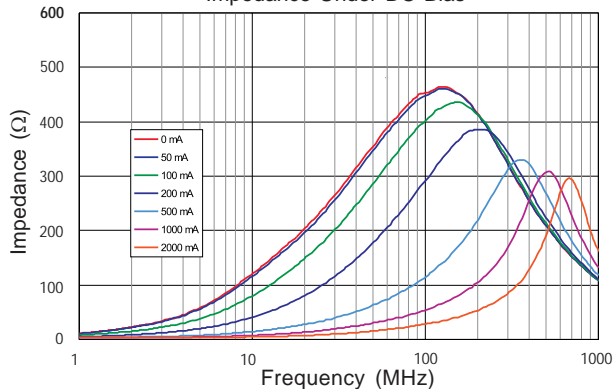

MI1806J800R-00

Z, R, X_L vs. Frequency
Impedance, Resistance, Inductive Reactance

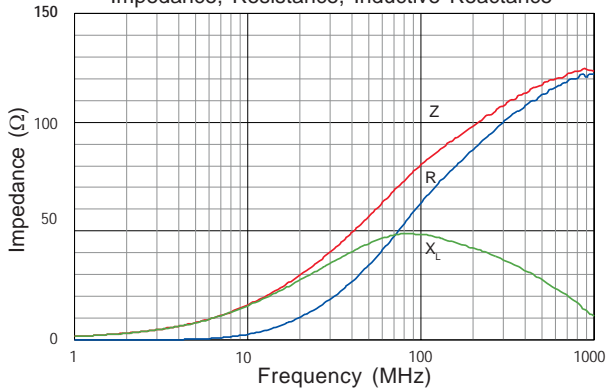

MI1806J800R-00

Z vs. Frequency
Impedance Under DC Bias

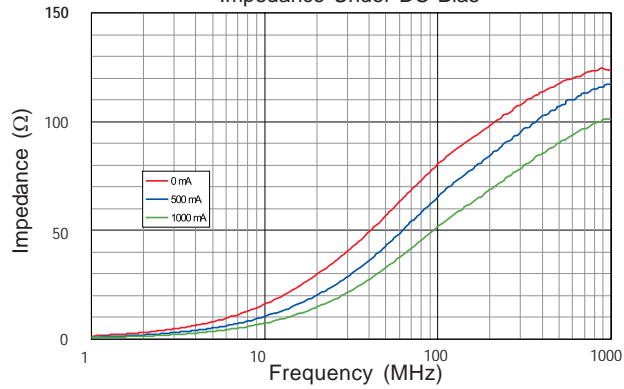

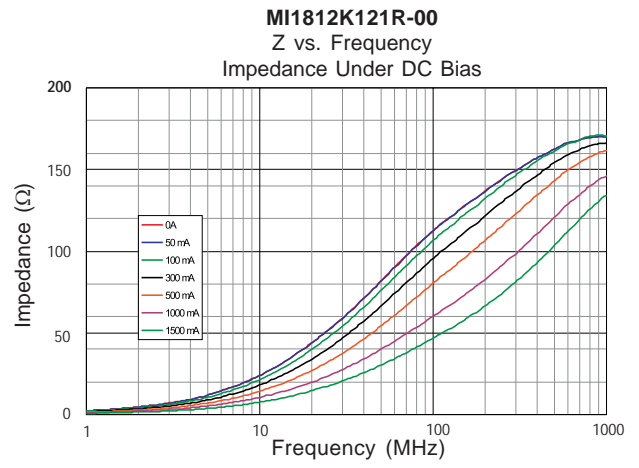
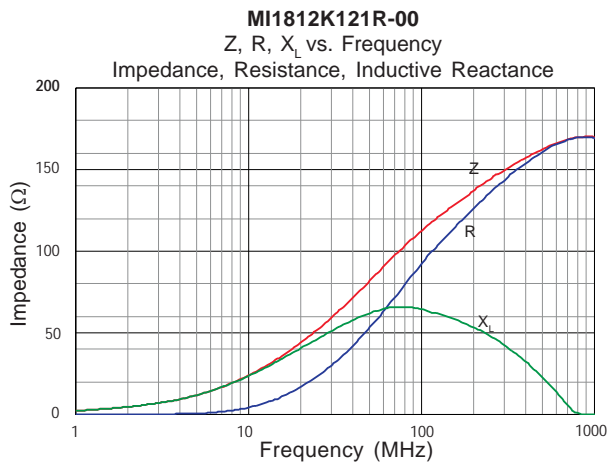

Tape & Reel Specifications

MI Tape Specifications															
P/N	A	A ₀	B	B ₀	C	D	D ₀	E	F	F ₀	F ₁	G	H	T	Reel Size
MI0603	2.21 (0.087)	1.88 ± 0.10 (0.074 ± 0.004)	3.76 (0.148)	3.56 ± 0.10 (0.140 ± 0.004)	1.91 ± 0.10 (0.075 ± 0.004)	3.50 ± 0.05 (0.138 ± 0.002)	1.75 ± 0.10 (0.069 ± 0.004)	4.00 ± 0.10 (0.157 ± 0.004)	1.00 ± 0.25 (0.039 ± 0.010)	2.00 ± 0.05 (0.079 ± 0.002)	1.50 ± 0.10 (0.059 ± 0.004)	8.00 ± 0.30 / -0.10 (0.315 ± 0.012 / -0.004)	4.00 ± 0.10 (0.157 ± 0.004)	0.25 ± 0.013 (0.010 ± 0.0005)	7"
MI0805	1.85 (0.073)	1.55 ± 0.10 (0.061 ± 0.004)	2.49 (0.098)	2.31 ± 0.10 (0.091 ± 0.004)	1.30 ± 0.10 (0.051 ± 0.004)	3.50 ± 0.05 (0.138 ± 0.002)	1.75 ± 0.10 (0.069 ± 0.004)	4.00 ± 0.10 (0.157 ± 0.004)	1.00 ± 0.25 (0.039 ± 0.010)	2.00 ± 0.05 (0.079 ± 0.002)	1.50 ± 0.10 (0.059 ± 0.004)	8.00 ± 0.30 / -0.10 (0.315 ± 0.012 / -0.004)	4.00 ± 0.10 (0.157 ± 0.004)	0.25 ± 0.013 (0.010 ± 0.0005)	7"
MI0805K	1.85 (0.073)	1.55 ± 0.10 (0.061 ± 0.004)	2.49 (0.098)	2.31 ± 0.10 (0.091 ± 0.004)	1.91 ± 0.10 (0.051 ± 0.004)	3.50 ± 0.05 (0.138 ± 0.002)	1.75 ± 0.10 (0.069 ± 0.004)	4.00 ± 0.10 (0.157 ± 0.004)	1.00 ± 0.25 (0.039 ± 0.010)	2.00 ± 0.05 (0.079 ± 0.002)	1.50 ± 0.10 (0.059 ± 0.004)	8.00 ± 0.30 / -0.10 (0.315 ± 0.012 / -0.004)	4.00 ± 0.10 (0.157 ± 0.004)	0.25 ± 0.013 (0.010 ± 0.0005)	7"
MI1206	2.21 (0.087)	1.88 ± 0.10 (0.074 ± 0.004)	3.76 (0.148)	3.56 ± 0.10 (0.140 ± 0.004)	1.40 ± 0.10 (0.055 ± 0.004)	3.50 ± 0.05 (0.138 ± 0.002)	1.75 ± 0.10 (0.069 ± 0.004)	4.00 ± 0.10 (0.157 ± 0.004)	1.00 ± 0.25 (0.039 ± 0.010)	2.00 ± 0.05 (0.079 ± 0.002)	1.50 ± 0.10 (0.059 ± 0.004)	8.00 ± 0.30 / -0.10 (0.315 ± 0.012 / -0.004)	4.00 ± 0.10 (0.157 ± 0.004)	0.25 ± 0.013 (0.010 ± 0.0005)	7"
MI1206K	2.21 (0.087)	1.88 ± 0.10 (0.074 ± 0.004)	3.76 (0.148)	3.56 ± 0.10 (0.140 ± 0.004)	1.91 ± 0.10 (0.075 ± 0.004)	3.50 ± 0.05 (0.138 ± 0.002)	1.75 ± 0.10 (0.069 ± 0.004)	4.00 ± 0.10 (0.157 ± 0.004)	1.00 ± 0.25 (0.039 ± 0.010)	2.00 ± 0.05 (0.079 ± 0.002)	1.50 ± 0.10 (0.059 ± 0.004)	8.00 ± 0.30 / -0.10 (0.315 ± 0.012 / -0.004)	4.00 ± 0.10 (0.157 ± 0.004)	0.25 ± 0.013 (0.010 ± 0.0005)	13"
MI1206L	2.21 (0.087)	1.88 ± 0.10 (0.074 ± 0.004)	3.76 (0.148)	3.56 ± 0.10 (0.140 ± 0.004)	1.10 ± 0.10 (0.043 ± 0.004)	3.50 ± 0.05 (0.138 ± 0.002)	1.75 ± 0.10 (0.069 ± 0.004)	4.00 ± 0.10 (0.157 ± 0.004)	1.00 ± 0.25 (0.039 ± 0.010)	2.00 ± 0.05 (0.079 ± 0.002)	1.50 ± 0.10 (0.059 ± 0.004)	8.00 ± 0.30 / -0.10 (0.315 ± 0.012 / -0.004)	4.00 ± 0.10 (0.157 ± 0.004)	0.25 ± 0.013 (0.010 ± 0.0005)	13"
MI1806	2.46 (0.097)	1.98 ± 0.10 (0.078 ± 0.004)	5.23 (0.206)	4.88 ± 0.10 (0.192 ± 0.004)	1.98 ± 0.10 (0.078 ± 0.004)	5.50 ± 0.05 (0.217 ± 0.002)	1.75 ± 0.10 (0.069 ± 0.004)	4.00 ± 0.10 (0.157 ± 0.004)	1.50 ± 0.25 (0.059 ± 0.010)	2.00 ± 0.05 (0.079 ± 0.002)	1.50 ± 0.10 (0.059 ± 0.004)	12.00 ± 0.30 / -0.10 (0.472 ± 0.012 / -0.004)	4.00 ± 0.10 (0.157 ± 0.004)	0.29 ± 0.013 (0.011 ± 0.0005)	7"
MI1812	3.99 (0.157)	3.51 ± 0.10 (0.138 ± 0.004)	5.08 (0.200)	4.78 ± 0.10 (0.188 ± 0.004)	1.73 ± 0.10 (0.068 ± 0.004)	5.50 ± 0.05 (0.217 ± 0.002)	1.75 ± 0.10 (0.069 ± 0.004)	8.00 ± 0.10 (0.315 ± 0.004)	1.50 ± 0.25 (0.059 ± 0.010)	2.00 ± 0.05 (0.079 ± 0.002)	1.50 ± 0.10 (0.059 ± 0.004)	12.00 ± 0.30 / -0.10 (0.472 ± 0.012 / -0.004)	4.00 ± 0.10 (0.157 ± 0.004)	0.29 ± 0.013 (0.011 ± 0.0005)	13"

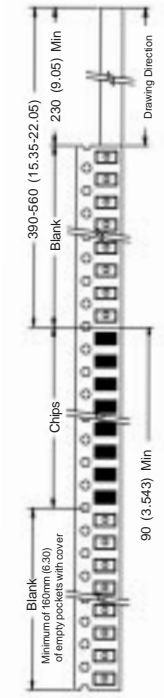
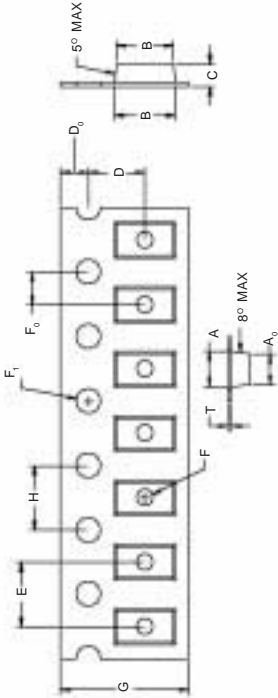

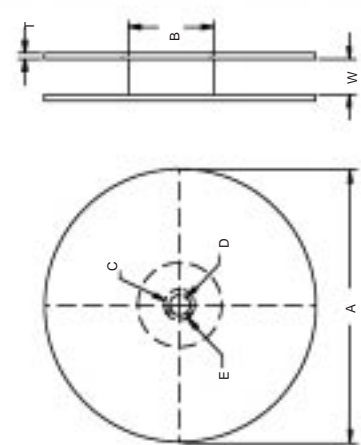

Reel Specifications	
A	330.0 / 178.0 ± 2.0 (13.00 / 7.00 ± 0.078)
B	95.0 ± 1.0 (3.74 ± 0.039)
C	13.0 ± 0.5 (0.51 ± 0.020)
D	21.0 ± 0.8 (0.82 ± 0.031)
E	2.0 ± 0.5 (0.08 ± 0.020)
W	8.0 ± 1.0 (0.32 ± 0.039)
T	1.0 (0.039)



Looking for pricing, stock, or lifecycle information?

Click below to explore more details on WIN SOURCE:

-  [View MI1812K121R-00 on WIN SOURCE](#)
-  [Laird-Signal Integrity Products Information](#)

Optimize Your Supply Chain with WIN SOURCE Solutions

-  Global Sourcing Solution
-  Obsolete Management
-  Cost Control Management
-  Shortage Management
-  Alternative Solution
-  Excess Inventory Management