



MIC2207

3mm x 3mm 2MHz 3A PWM Buck Regulator

General Description

The Micrel MIC2207 is a high-efficiency PWM buck (step-down) regulators that provides up to 3A of output current. The MIC2207 operates at 2MHz and has proprietary internal compensation that allows a closed loop bandwidth of over 200KHz.

The low on-resistance internal p-channel MOSFET of the MIC2207 allows efficiencies over 94%, reduces external components count and eliminates the need for an expensive current sense resistor.

The MIC2207 operates from 2.7V to 5.5V input and the output can be adjusted down to 1V. The devices can operate with a maximum duty cycle of 100% for use in low-dropout conditions.

The MIC2207 is available in the exposed pad 12-pin 3mm x 3mm MLF[®] package with a junction operating range from -40°C to +125°C.

Data sheets and support documentation can be found on Micrel's web site at: www.micrel.com.

Features

- 2.7 to 5.5V supply voltage
- 2MHz PWM mode
- Output current to 3A
- >94% efficiency
- 100% maximum duty cycle
- Adjustable output voltage option down to 1V
- Ultra-fast transient response
- Ultra-small external components
Stable with a 1 μ H inductor and a 4.7 μ F output capacitor
- Fully integrated 3A MOSFET switch
- Micropower shutdown
- Thermal shutdown and current limit protection
- Pb-free 12-pin 3mm x 3mm MLF[®] package
- -40°C to +125°C junction temperature range

Applications

- 5V or 3.3V Point of Load Conversion
- Telecom/Networking Equipment
- Set Top Boxes
- Storage Equipment
- Video Cards
- DDR Power Supply

Typical Application

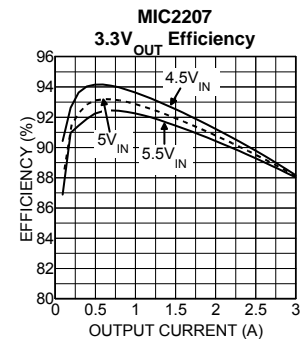
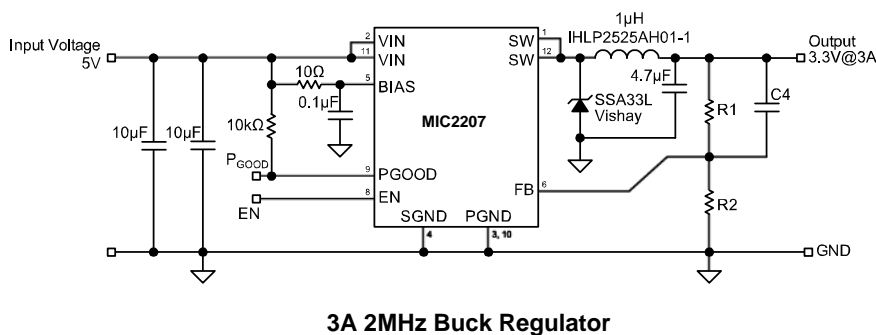

MLF and MicroLeadFrame are registered trademarks of Amkor Technology, Inc.

Micrel Inc. • 2180 Fortune Drive • San Jose, CA 95131 • USA • tel +1 (408) 944-0800 • fax + 1 (408) 474-1000 • <http://www.micrel.com>

Ordering Information

| Part Number | Output Voltage ⁽¹⁾ | Junction Temp. Range | Package | Lead Finish |
|-------------|-------------------------------|----------------------|-----------------------------------|-------------|
| MIC2207YML | Adj. | -40° to +125°C | 12-Pin 3mm x 3mm MLF [®] | Pb-free |

Note:

1. Other Voltage options available. Contact Micrel for details.

Pin Configuration

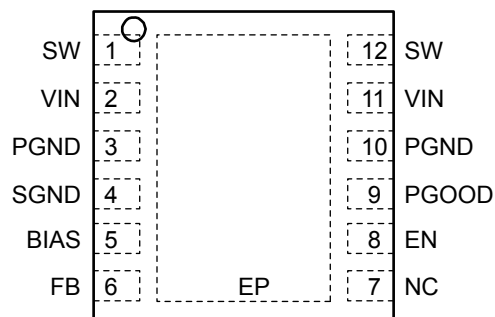

12-Pin 3mm x 3mm MLF[®] (ML)

Pin Description

| Pin Number | Pin Name | Pin Function |
|------------|----------|---|
| 1,12 | SW | Switch (Output): Internal power P-Channel MOSFET output switch |
| 2,11 | VIN | Supply Voltage (Input): Supply voltage for the source of the internal P-channel MOSFET and driver. Requires bypass capacitor to GND. |
| 3,10 | PGND | Power Ground. Provides the ground return path for the high-side drive current. |
| 4 | SGND | Signal (Analog) Ground. Provides return path for control circuitry and internal reference. |
| 5 | BIAS | Internal circuit bias supply. Must be bypassed with a 0.1µF ceramic capacitor to SGND. |
| 6 | FB | Feedback. Input to the error amplifier, connect to the external resistor divider network to set the output voltage. |
| 7 | NC | No Connect. Not internally connected to die. This pin can be tied to any other pin if desired. |
| 8 | EN | Enable (Input). Logic level low will shutdown the device, reducing the current draw to less than 5µA. |
| 9 | PGOOD | Power Good. Open drain output that is pulled to ground when the output voltage is within ±7.5% of the set regulation voltage |
| EP | GND | Connect to ground. |

Absolute Maximum Ratings⁽¹⁾

| | |
|------------------------------------|-------------------|
| Supply Voltage (V_{IN}) | +6V |
| Output Switch Voltage (V_{SW}) | +6V |
| Output Switch Current (I_{SW}) | 11A |
| Logic Input Voltage (V_{EN}) | -0.3V to V_{IN} |
| Storage Temperature (T_s) | -60°C to +150°C |
| ESD Rating ⁽³⁾ | 2kV |

Operating Ratings⁽²⁾

| | |
|--|-----------------|
| Supply Voltage (V_{IN}) | +2.7V to +5.5V |
| Logic Input Voltage (V_{EN}) | 0V to V_{IN} |
| Junction Temperature (T_J) | -40°C to +125°C |
| Junction Thermal Resistance 3x3 MLF-12L (θ_{JA}) | 60°C/W |

Electrical Characteristics⁽⁴⁾

$V_{IN} = V_{EN} = 3.6V$; $L = 1\mu H$; $C_{OUT} = 4.7\mu F$; $T_A = 25^\circ C$, unless noted. **Bold** values indicate $-40^\circ C \leq T_J \leq +125^\circ C$.

| Parameter | Condition | Min | Typ | Max | Units |
|---------------------------------|---|---------------------|---------|---------------------|------------|
| Supply Voltage Range | | 2.7 | | 5.5 | V |
| Under-Voltage Lockout Threshold | (turn-on) | 2.45 | 2.55 | 2.65 | V |
| UVLO Hysteresis | | | 100 | | mV |
| Quiescent Current | $V_{FB} = 0.9 * V_{NOM}$ (not switching) | | 570 | 900 | μA |
| Shutdown Current | $V_{EN} = 0V$ | | 2 | 10 | μA |
| [Adjustable] Feedback Voltage | $\pm 1\% I_{LOAD} = 100mA$ $\pm 2\%$ (over temperature) $I_{LOAD} = 100mA$ | 0.99 0.98 | 1 | 1.01 1.02 | V |
| FB pin input current | | | 1 | | nA |
| Current Limit in PWM Mode | $V_{FB} = 0.9 * V_{NOM}$ | 3.5 | 5 | | A |
| Output Voltage Line Regulation | $V_{OUT} > 2V$; $V_{IN} = V_{OUT} + 500mV$ to 5.5V; $I_{LOAD} = 100mA$ $V_{OUT} < 2V$; $V_{IN} = 2.7V$ to 5.5V; $I_{LOAD} = 100mA$ | | 0.07 | | % |
| Output Voltage Load Regulation | $20mA < I_{LOAD} < 3A$ | | 0.2 | 0.5 | % |
| Maximum Duty Cycle | $V_{FB} \leq 0.4V$ | 100 | | | % |
| PWM Switch ON-Resistance | $I_{SW} = 50mA$; $V_{FB} = 0.7V_{FB_NOM}$ (High Side Switch) | | 95 | 200 300 | m Ω |
| Oscillator Frequency | | 1.8 | 2 | 2.2 | MHz |
| Enable Threshold | | 0.5 | 0.85 | 1.3 | V |
| Enable Hysteresis | | | 50 | | mV |
| Enable Input Current | | | 0.1 | 2 | μA |
| Power Good Range | | | ± 7 | ± 10 | % |
| Power Good Resistance | $I_{PGOOD} = 500\mu A$ | | 145 | 250 | Ω |
| Over-Temperature Shutdown | | | 160 | | $^\circ C$ |
| Over-Temperature Hysteresis | | | 20 | | $^\circ C$ |

Notes:

- Exceeding the absolute maximum rating may damage the device.
- The device is not guaranteed to function outside its operating rating.
- Devices are ESD sensitive. Handling precautions recommended. Human body model, 1.5k in series with 100pF.
- Specification for packaged product only.
- Dropout voltage is defined as the input-to-output differential at which the output voltage drops 2% below its nominal value that is initially measured at a 1V differential. For outputs below 2.7V, the dropout voltage is the input-to-output voltage differential with a minimum input voltage of 2.7V.

Typical Characteristics

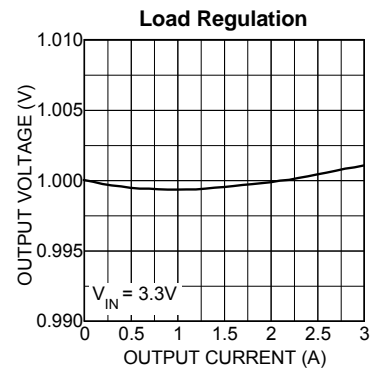
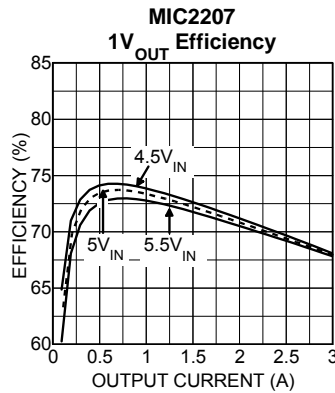
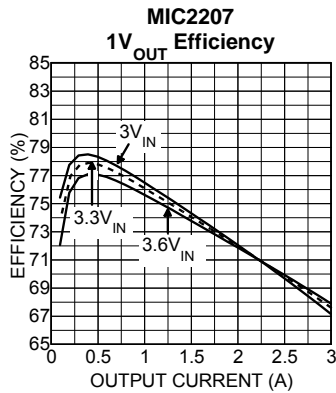
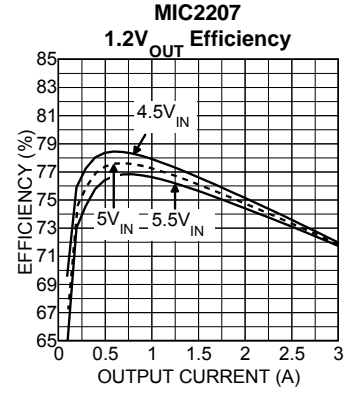
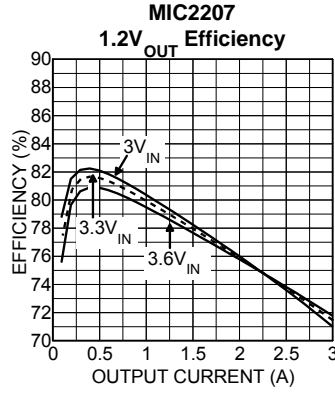
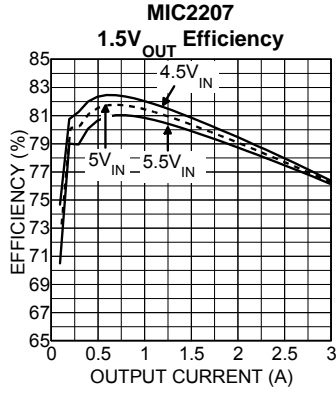
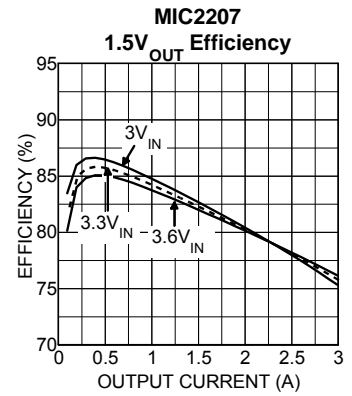
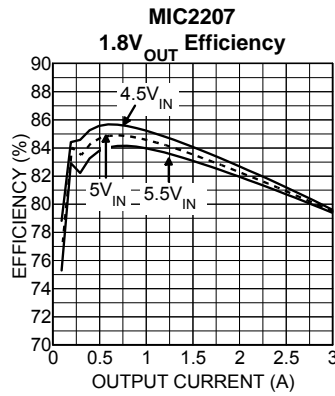
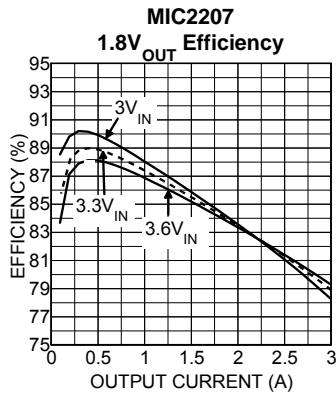
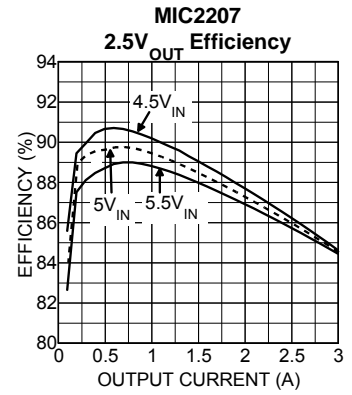
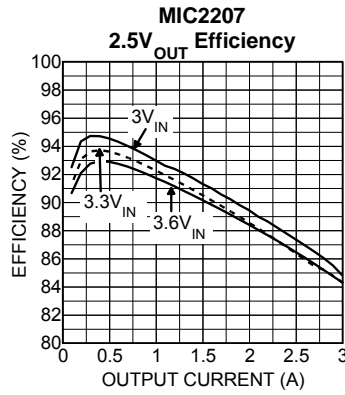
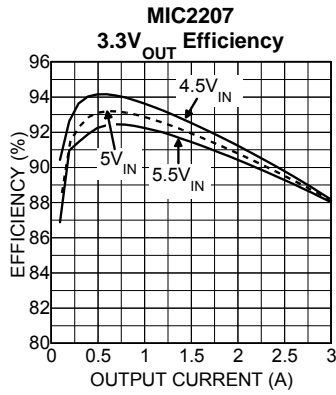

Typical Characteristics (cont.)

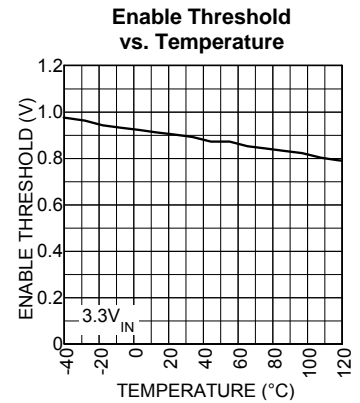
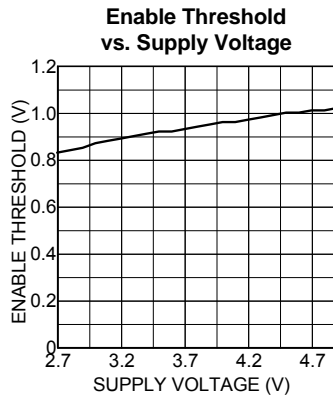
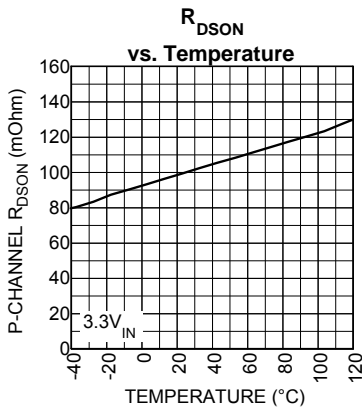
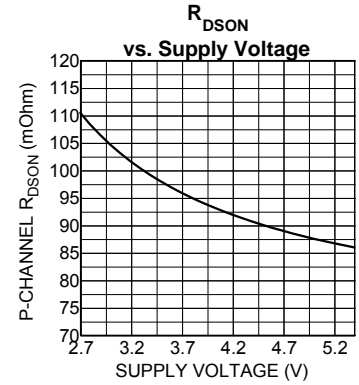
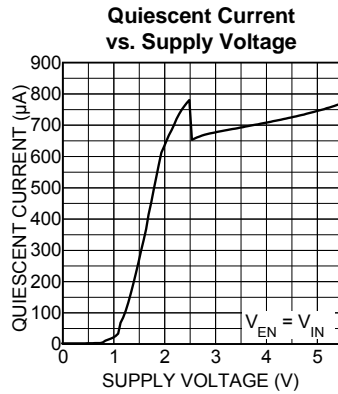
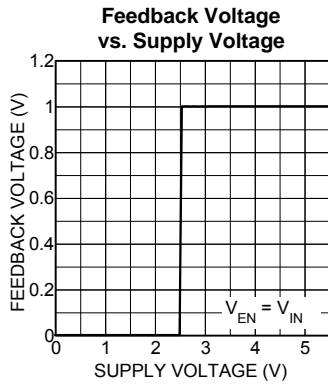
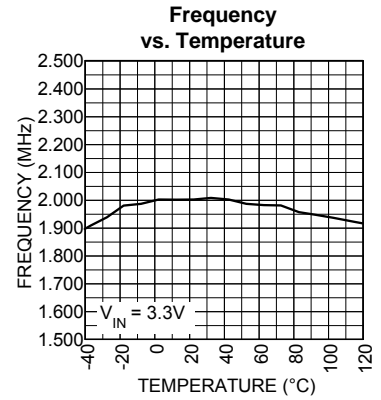
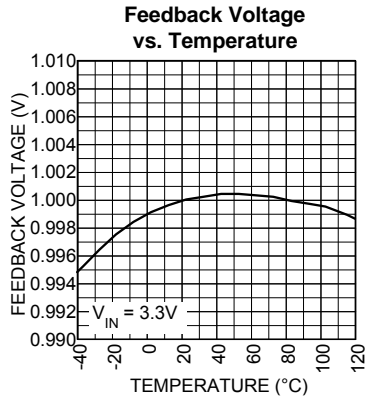
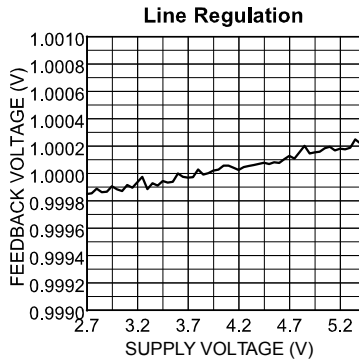

Functional Characteristics

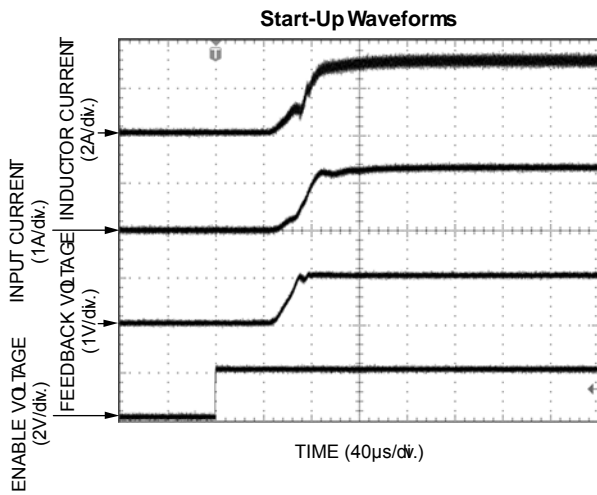
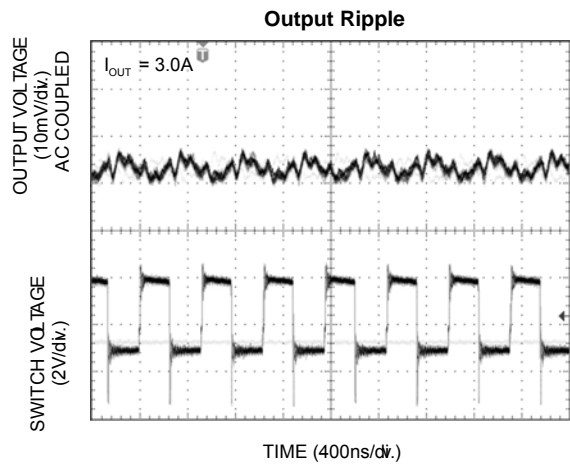
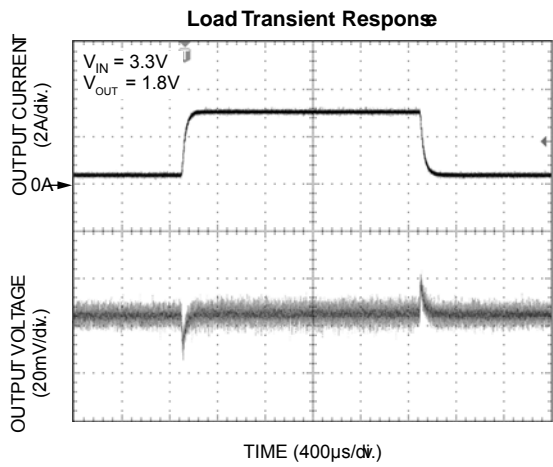
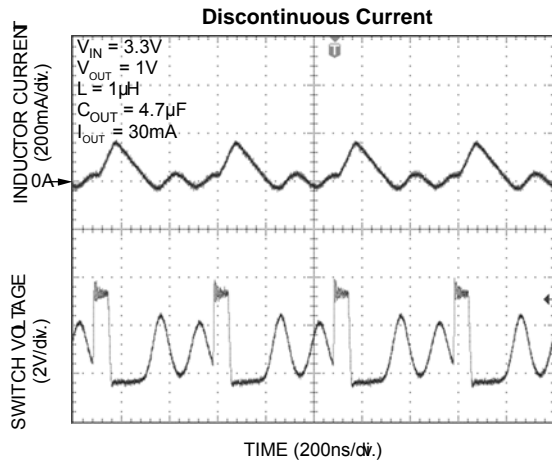
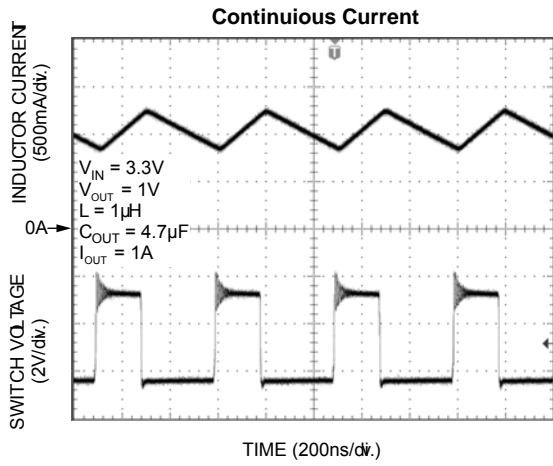

Functional Diagram

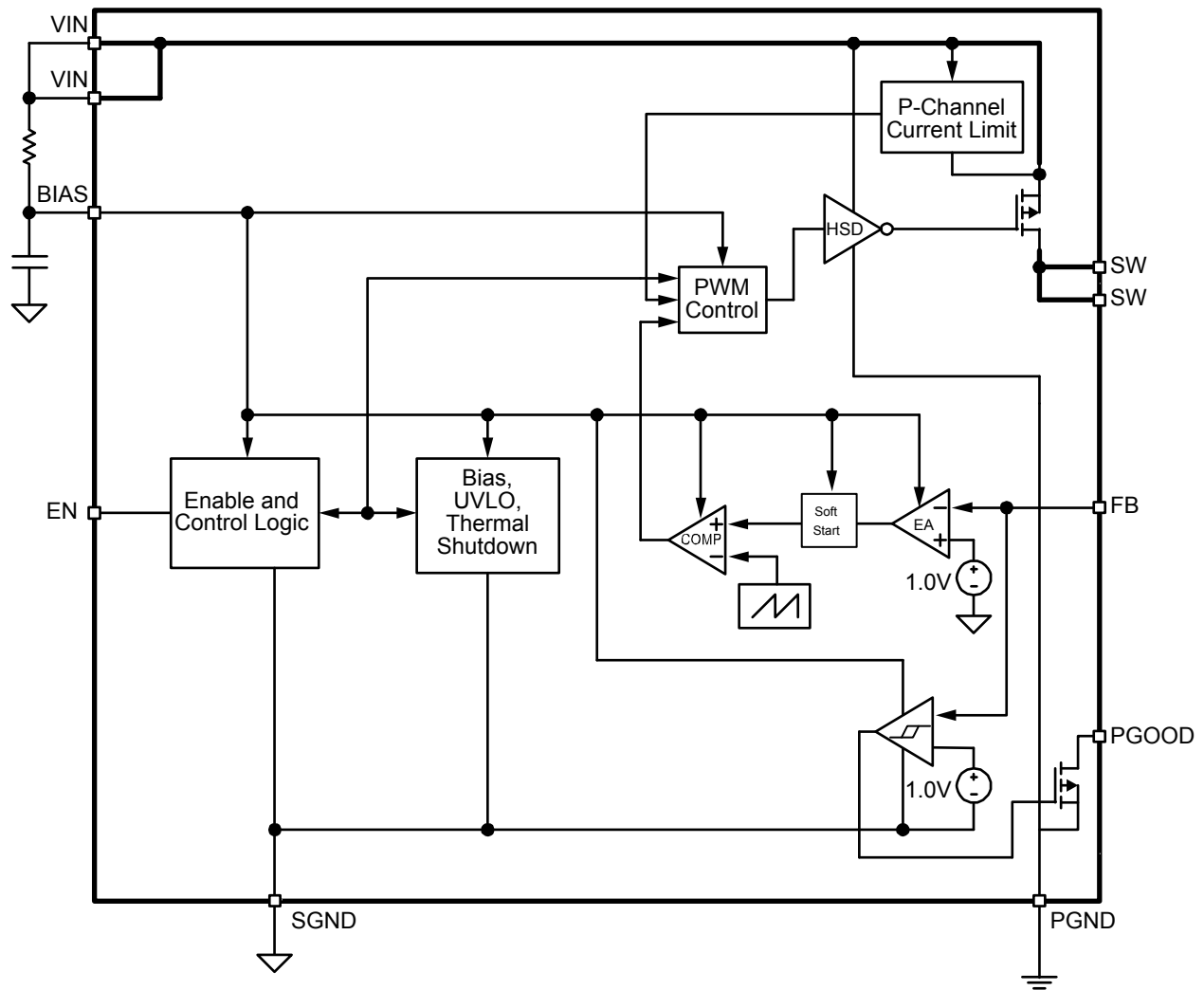

MIC2207 Block Diagram

Pin Descriptions

VIN

Two pins for VIN provide power to the source of the internal P-channel MOSFET along with the current limiting sensing. The VIN operating voltage range is from 2.7V to 5.5V. Due to the high switching speeds, a 10 μ F capacitor is recommended close to VIN and the power ground (PGND) for each pin for bypassing. Please refer to layout recommendations.

BIAS

The bias (BIAS) provides power to the internal reference and control sections of the MIC2207. A 10 Ω resistor from VIN to BIAS and a 0.1 μ F from BIAS to SGND is required for clean operation.

EN

The enable pin provides a logic level control of the output. In the off state, supply current of the device is greatly reduced (typically <1 μ A). Do not drive the enable pin above the supply voltage.

FB

The feedback pin (FB) provides the control path to control the output. For adjustable versions, a resistor divider connecting the feedback to the output is used to adjust the desired output voltage. The output voltage is calculated as follows:

$$V_{OUT} = V_{REF} \times \left(\frac{R1}{R2} + 1 \right)$$

where V_{REF} is equal to 1.0V.

A feedforward capacitor is recommended for most designs using the adjustable output voltage option. To reduce current draw, a 10K feedback resistor is recommended from the output to the FB pin (R1). Also, a feedforward capacitor should be connected between the output and feedback (across R1). The large resistor value and the parasitic capacitance of the FB pin can cause a high frequency pole that can reduce the overall system phase margin. By placing a feedforward capacitor, these effects can be significantly reduced. Feedforward capacitance (C_{FF}) can be calculated as follows:

$$C_{FF} = \frac{1}{2\pi \times R1 \times 200\text{kHz}}$$

SW

The switch (SW) pin connects directly to the inductor and provides the switching current necessary to operate in PWM mode. Due to the high speed switching on this pin, the switch node should be routed away from sensitive nodes. This pin also connects to the cathode of the free-wheeling diode.

PGOOD

Power good is an open drain pull down that indicates when the output voltage has reached regulation. For a power good low, the output voltage is within $\pm 10\%$ of the set regulation voltage. For output voltages greater or less than 10%, the PGOOD pin is high. This should be connected to the input supply through a pull up resistor. A delay can be added by placing a capacitor from PGOOD to ground.

PGND

Power ground (PGND) is the ground path for the MOSFET drive current. The current loop for the power ground should be as small as possible and separate from the Signal ground (SGND) loop. Refer to the layout considerations for more details.

SGND

Signal ground (SGND) is the ground path for the biasing and control circuitry. The current loop for the signal ground should be separate from the power ground (PGND) loop. Refer to the layout considerations for more details.

Application Information

The MIC2207 is a 3A PWM non-synchronous buck regulator. By switching an input voltage supply, and filtering the switched voltage through an Inductor and capacitor, a regulated DC voltage is obtained. Figure 1 shows a simplified example of a non-synchronous buck converter.

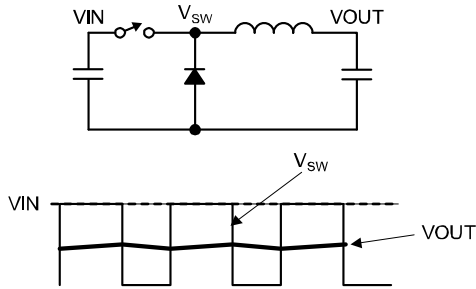

Figure 1.

For a non-synchronous buck converter, there are two modes of operation; continuous and discontinuous. Continuous or discontinuous refer to the inductor current. If current is continuously flowing through the inductor throughout the switching cycle, it is in continuous operation. If the inductor current drops to zero during the off time, it is in discontinuous operation. Critically continuous is the point where any decrease in output current will cause it to enter discontinuous operation. The critically continuous load current can be calculated as follows;

$$V_{OUT} = \frac{\left[V_{OUT} - \frac{V_{OUT}^2}{V_{IN}} \right]}{2MHz \times 2 \times L}$$

Continuous or discontinuous operation determines how we calculate peak inductor current.

Continuous Operation

Figure 2 illustrates the switch voltage and inductor current during continuous operation.

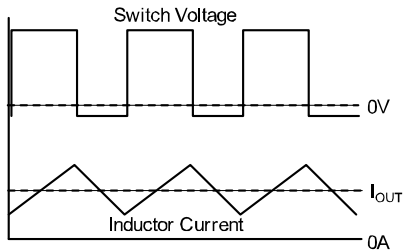

Figure 2. Continuous Operation

The output voltage is regulated by pulse width modulating (PWM) the switch voltage to the average required output voltage. The switching can be broken up into two cycles; On and Off.

During the on-time, the high side switch is turned on, current flows from the input supply through the inductor and to the output. The inductor current is

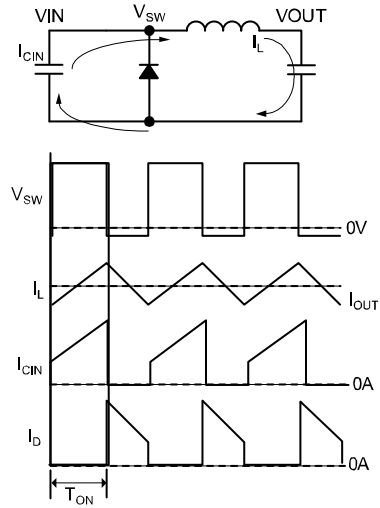

Figure 3. On-Time

charged at the rate;

$$\frac{(V_{IN} - V_{OUT})}{L}$$

To determine the total on-time, or time at which the inductor charges, the duty cycle needs to be calculated. The duty cycle can be calculated as;

$$D = \frac{V_{OUT}}{V_{IN}}$$

and the On time is;

$$T_{ON} = \frac{D}{2MHz}$$

Therefore, peak to peak ripple current is;

$$I_{pk-pk} = \frac{(V_{IN} - V_{OUT}) \times \frac{V_{OUT}}{V_{IN}}}{2MHz \times L}$$

Since the average peak to peak current is equal to the load current. The actual peak (or highest current the inductor will see in a steady state condition) is equal to the output current plus 1/2 the peak to peak current.

$$I_{pk} = I_{OUT} + \frac{(V_{IN} - V_{OUT}) \times \frac{V_{OUT}}{V_{IN}}}{2 \times 2MHz \times L}$$

Figure 4 demonstrates the off-time. During the off-time, the high-side internal P-channel MOSFET turns off. Since the current in the inductor has to discharge, the current flows through the free-wheeling Schottky diode to the output. In this case, the inductor discharge rate is (where V_D is the diode forward voltage);

$$\frac{(V_{OUT} + V_D)}{L}$$

The total off time can be calculated as;

$$T_{OFF} = \frac{1 - D}{2MHz}$$

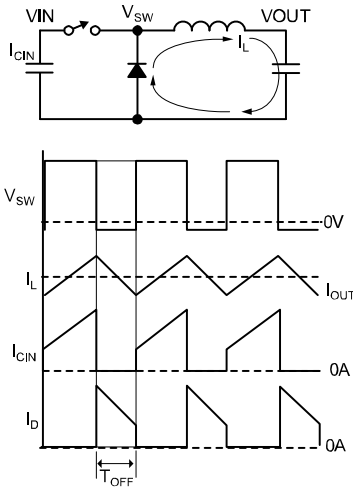

Figure 4. Off-Time

Discontinuous Operation

Discontinuous operation is when the inductor current discharges to zero during the off cycle. Figure 5. demonstrates the switch voltage and inductor currents during discontinuous operation.

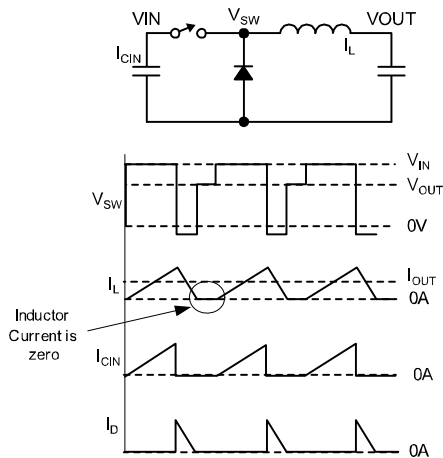

Figure 5. Discontinuous Operation

When the inductor current (I_L) has completely discharged, the voltage on the switch node rings at the frequency determined by the parasitic capacitance and the inductor value. In figure 5, it is drawn as a DC voltage, but to see actual operation (with ringing) refer to the functional characteristics.

Discontinuous mode of operation has the advantage over full PWM in that at light loads, the MIC2207 will skip

pulses as necessary, reducing gate drive losses, drastically improving light load efficiency.

Efficiency Considerations

Calculating the efficiency is as simple as measuring power out and dividing it by the power in;

$$\text{Efficiency} = \frac{P_{OUT}}{P_{IN}} \times 100$$

Where input power (P_{IN}) is;

$$P_{IN} = V_{IN} \times I_{IN}$$

and output power (P_{OUT}) is calculated as;

$$P_{OUT} = V_{OUT} \times I_{OUT}$$

The Efficiency of the MIC2207 is determined by several factors.

- R_{dson} (Internal P-channel Resistance)
- Diode conduction losses
- Inductor Conduction losses
- Switching losses

R_{dson} losses are caused by the current flowing through the high side P-channel MOSFET. The amount of power loss can be approximated by;

$$P_{SW} = R_{DSON} \times I_{OUT}^2 \times D$$

Where D is the duty cycle.

Since the MIC2207 uses an internal P-channel MOSFET, R_{dson} losses are inversely proportional to supply voltage. Higher supply voltage yields a higher gate to source voltage, reducing the R_{dson}, reducing the MOSFET conduction losses. A graph showing typical R_{dson} vs input supply voltage can be found in the typical characteristics section of this datasheet.

Diode conduction losses occur due to the forward voltage drop (V_F) and the output current. Diode power losses can be approximated as follows;

$$P_D = V_F \times I_{OUT} \times (1 - D)$$

For this reason, the schottky diode is the rectifier of choice. Using the lowest forward voltage drop will help reduce diode conduction losses, and improve efficiency.

Duty cycle, or the ratio of output voltage to input voltage, determines whether the dominant factor in conduction losses will be the internal MOSFET or the schottky diode. Higher duty cycles place the power losses on the high side switch, and lower duty cycles place the power losses on the schottky diode.

Inductor conduction losses (P_L) can be calculated by multiplying the DC resistance (DCR) times the square of the output current;

$$P_L = DCR \times I_{OUT}^2$$

Also, be aware that there are additional core losses associated with switching current in an inductor. Since most inductor manufacturers do not give data on the type of material used, approximating core losses becomes very difficult, so verify inductor temperature rise.

Switching losses occur twice each cycle, when the switch turns on and when the switch turns off. This is caused by a non-ideal world where switching transitions are not instantaneous, and neither are currents. Figure 6 demonstrates (Or exaggerates...) how switching losses due to the transitions dissipate power in the switch.

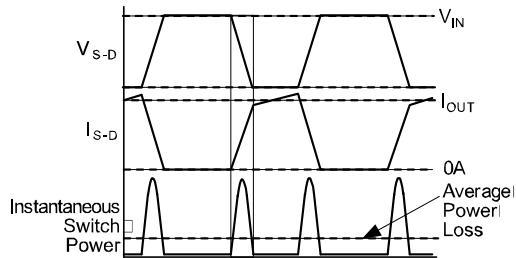

Figure 6. Switching Transition Losses

Normally, when the switch is on, the voltage across the switch is low (virtually zero) and the current through the switch is high. This equates to low power dissipation. When the switch is off, voltage across the switch is high and the current is zero, again with power dissipation being low. During the transitions, the voltage across the switch (V_{S-D}) and the current through the switch (I_{S-D}) are at midpoint of their excursions and cause the transition to be the highest instantaneous power point. During continuous mode, these losses are the highest. Also, with higher load currents, these losses are higher. For discontinuous operation, the transition losses only occur during the “off” transition since the “on” transitions there is no current flow through the inductor.

Component Selection

Input Capacitor

A 10 μ F ceramic is recommended on each VIN pin for bypassing. X5R or X7R dielectrics are recommended for the input capacitor. Y5V dielectrics lose most of their capacitance over temperature and are therefore not recommended. Also, tantalum and electrolytic capacitors alone are not recommended because of their reduced RMS current handling, reliability, and ESR increases.

An additional 0.1 μ F is recommended close to the VIN and PGND pins for high frequency filtering. Smaller case size capacitors are recommended due to their lower ESR and ESL. Please refer to layout recommendations for proper layout of the input capacitor.

Output Capacitor

The MIC2207 is designed for a 4.7 μ F output capacitor. X5R or X7R dielectrics are recommended for the output capacitor. Y5V dielectrics lose most of their capacitance over temperature and are therefore not recommended.

In addition to a 4.7 μ F, a small 0.1 μ F is recommended close to the load for high frequency filtering. Smaller case size capacitors are recommended due to their lower equivalent series ESR and ESL.

The MIC2207 utilizes type III voltage mode internal compensation and utilizes an internal zero to compensate for the double pole roll off of the LC filter. For this reason, larger output capacitors can create instabilities. In cases where a 4.7 μ F output capacitor is not sufficient, the MIC2208 offers the ability to externally control the compensation, allowing for a wide range of output capacitor types and values.

Inductor Selection

The MIC2207 is designed for use with a 1 μ H inductor. Proper selection should ensure the inductor can handle the maximum average and peak currents required by the load. Maximum current ratings of the inductor are generally given in two methods; permissible DC current and saturation current. Permissible DC current can be rated either for a 40°C temperature rise or a 10% to 20% loss in inductance. Ensure the inductor selected can handle the maximum operating current. When saturation current is specified, make sure that there is enough margin that the peak current will not saturate the inductor.

Diode Selection

Since the MIC2207 is non-synchronous, a free-wheeling diode is required for proper operation. A schottky diode is recommended due to the low forward voltage drop and their fast reverse recovery time. The diode should be rated to be able to handle the average output current. Also, the reverse voltage rating of the diode should exceed the maximum input voltage. The lower the forward voltage drop of the diode the better the efficiency. Please refer to the layout recommendations to minimize switching noise.

Feedback Resistors

The feedback resistor set the output voltage by dividing down the output and sending it to the feedback pin. The feedback voltage is 1.0V. Calculating the set output voltage is as follows;

$$V_{OUT} = V_{FB} \left(\frac{R1}{R2} + 1 \right)$$

Where R1 is the resistor from VOUT to FB and R2 is the resistor from FB to GND. The recommended feedback resistor values for common output voltages are available

in the bill of materials on page 19. Although the range of resistance for the FB resistors is very wide, R1 is recommended to be 10K. This minimizes the effect the parasitic capacitance of the FB node.

Feedforward Capacitor (C_{FF})

A capacitor across the resistor from the output to the feedback pin (R1) is recommended for most designs. This capacitor can give a boost to phase margin and increase the bandwidth for transient response. Also, large values of feedforward capacitance can slow down the turn-on characteristics, reducing inrush current. For maximum phase boost, C_{FF} can be calculated as follows;

$$C_{FF} = \frac{1}{2\pi \times 200\text{kHz} \times R1}$$

Bias filter

A small 10Ω resistor is recommended from the input supply to the bias pin along with a small 0.1μF ceramic capacitor from bias to ground. This will bypass the high frequency noise generated by the violent switching of high currents from reaching the internal reference and control circuitry. Tantalum and electrolytic capacitors are not recommended for the bias, these types of capacitors lose their ability to filter at high frequencies.

Loop Stability and Bode Analysis

Bode analysis is an excellent way to measure small signal stability and loop response in power supply designs. Bode analysis monitors gain and phase of a control loop. This is done by breaking the feedback loop and injecting a signal into the feedback node and comparing the injected signal to the output signal of the control loop. This will require a network analyzer to sweep the frequency and compare the injected signal to the output signal. The most common method of injection is the use of a transformer. Figure 7 demonstrates how a transformer is used to inject a signal into the feedback network.

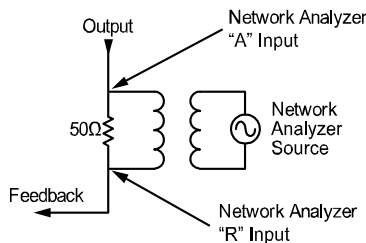

Figure 7. Transformer Injection

A 50Ω resistor allows impedance matching from the network analyzer source. This method allows the DC loop to maintain regulation and allow the network analyzer to insert an AC signal on top of the DC voltage. The network analyzer will then sweep the source while

monitoring A and R for an A/R measurement. While this is the most common method for measuring the gain and phase of a power supply, it does have significant limitations. First, to measure low frequency gain and phase, the transformer needs to be high in inductance. This makes frequencies <100Hz require an extremely large and expensive transformer. Conversely, it must be able to inject high frequencies. Transformers with these wide frequency ranges generally need to be custom made and are extremely expensive (usually to the tune of several hundred dollars!). By using an op-amp, cost and frequency limitations caused by an injection transformer are completely eliminated. Figure 8 demonstrates using an op-amp in a summing amplifier configuration for signal injection.

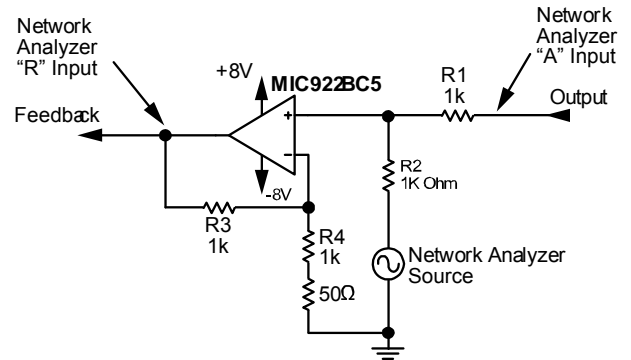

Figure 8. Op Amp Injection

R1 and R2 reduce the DC voltage from the output to the non-inverting input by half. The network analyzer is generally a 50Ω source. R1 and R2 also divide the AC signal sourced by the network analyzer by half. These two signals are “summed” together at half of their original input. The output is then amplified by 2 by R3 and R4 (the 50Ω is to balance the network analyzer’s source impedance) and sent to the feedback signal. This essentially breaks the loop and injects the AC signal on top of the DC output voltage and sends it to the feedback. By monitoring the feedback “R” and output “A”, gain and phase are measured. This method has no minimum frequency. Ensure that the bandwidth of the op-amp being used is much greater than the expected bandwidth of the power supply’s control loop. An op-amp with >100MHz bandwidth is more than sufficient for most power supplies (which includes both linear and switching) and are more common and significantly cheaper than the injection transformers previously mentioned. The one disadvantage to using the op-amp injection method, is the supply voltages need to be below the maximum operating voltage of the op-amp. Also, the maximum output voltage for driving 50Ω inputs using the MIC922 is 3V. For measuring higher output voltages, a 1MΩ input impedance is required for the A and R channels. Remember to always measure the

output voltage with an oscilloscope to ensure the measurement is working properly. You should see a single sweeping sinusoidal waveform without distortion on the output. If there is distortion of the sinusoid, reduce the amplitude of the source signal. You could be overdriving the feedback causing a large signal response.

The following Bode analysis show the small signal loop stability of the MIC2207. The MIC2207 utilizes a type III compensation. This is a dominant low frequency pole, followed by 2 zero's and finally the double pole of the inductor capacitor filter, creating a final 20dB/decade roll off. Bode analysis gives us a few important data points; speed of response (Gain Bandwidth or GBW) and loop stability. Loop speed or GBW determines the response time to a load transient. Faster response times yield smaller voltage deviations to load steps.

Instability in a control loop occurs when there is gain and positive feedback. Phase margin is the measure of how stable the given system is. It is measured by determining how far the phase is from crossing zero when the gain is equal to 1 (0dB).

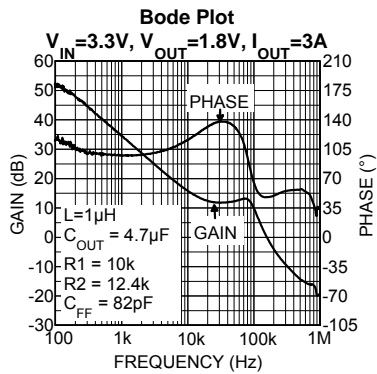

Typically for 3.3Vin and 1.8Vout at 3A;

- **Phase Margin=47 Degrees**
- **GBW=156KHz**

Gain will also increase with input voltage. The following graph shows the increase in GBW for an increase in supply voltage.

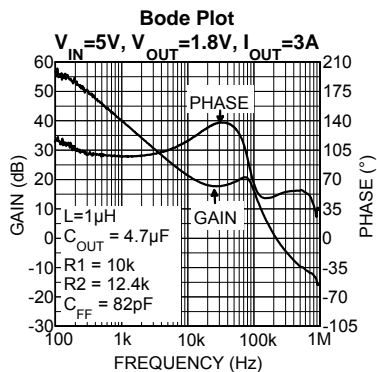

5Vin, 1.8Vout at 3A load;

- **Phase Margin=43.1 Degrees**
- **GBW= 218KHz**

Being that the MIC2207 is non-synchronous; the regulator only has the ability to source current. This means that the regulator has to rely on the load to be able to sink current. This causes a non-linear response at light loads. The following plot shows the effects of the pole created by the nonlinearity of the output drive during light load (discontinuous) conditions.

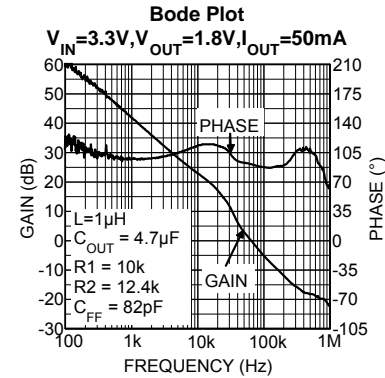

3.3Vin, 1.8Vout Iout=50mA;

- **Phase Margin=90.5 Degrees**
- **GBW= 64.4KHz**

Feed Forward Capacitor

The feedback resistors are a gain reduction block in the overall system response of the regulator. By placing a capacitor from the output to the feedback pin, high frequency signal can bypass the resistor divider, causing a gain increase up to unity gain.

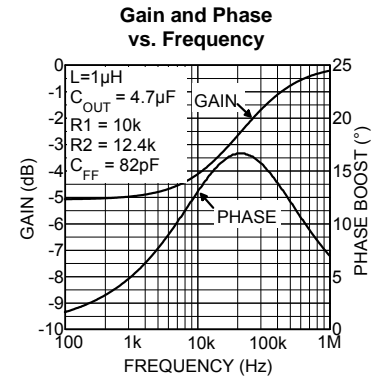

The graph above shows the effects on the gain and phase of the system caused by feedback resistors and a feedforward capacitor. The maximum amount of phase boost achievable with a feedforward capacitor is graphed below.

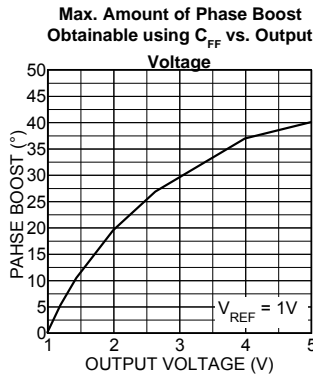

By looking at the graph, phase margin can be affected to a greater degree with higher output voltages.

The next bode plot shows the phase margin of a 1.8V output at 3A without a feedforward capacitor.

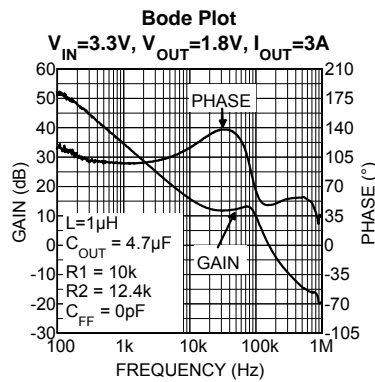

As you can see the typical phase margin, using the same resistor values as before without a feedforward capacitor results in 33.6 degrees of phase margin. Our prior measurement with a feedforward capacitor yielded a phase margin of 47 degrees. The feedforward capacitor has given us a phase boost of 13.4 degrees (47 degrees – 33.6 Degrees = 13.4 Degrees).

Output Impedance and Transient response

Output impedance, simply stated, is the amount of output voltage deviation vs. the load current deviation. The lower the output impedance, the better.

$$Z_{OUT} = \frac{\Delta V_{OUT}}{\Delta I_{OUT}}$$

Output impedance for a buck regulator is the parallel impedance of the output capacitor and the MOSFET and inductor divided by the gain;

$$Z_{TOTAL} = \frac{R_{DS(ON)} + DCR + X_L}{GAIN} \parallel X_{COUT}$$

To measure output impedance vs. frequency, the load current must be swept across the frequencies measured, while the output voltage is monitored. Fig 9 shows a test

set-up to measure output impedance from 10Hz to 1MHz using the MIC5190 high speed controller.

By setting up a network analyzer to sweep the feedback current, while monitoring the output of the voltage regulator and the voltage across the load resistance, output impedance is easily obtainable. To keep the current from being too high, a DC offset needs to be applied to the network analyzer's source signal. This can be done with an external supply and 50Ω resistor. Make sure that the currents are verified with an oscilloscope first, to ensure the integrity of the signal measurement. It is always a good idea to monitor the A and R measurements with a scope while you are sweeping it. To convert the network analyzer data from dBm to something more useful (such as peak to peak voltage and current in our case);

$$\Delta V = \frac{\sqrt{10^{\frac{dBm}{10}} \times 1mW \times 50\Omega \times 2}}{0.707}$$

and peak to peak current;

$$\Delta I = \frac{\sqrt{10^{\frac{dBm}{10}} \times 1mW \times 50\Omega \times 2}}{0.707 \times R_{LOAD}}$$

The following graph shows output impedance vs frequency at 2A load current sweeping the AC current from 10Hz to 10MHz, at 1A peak to peak amplitude.

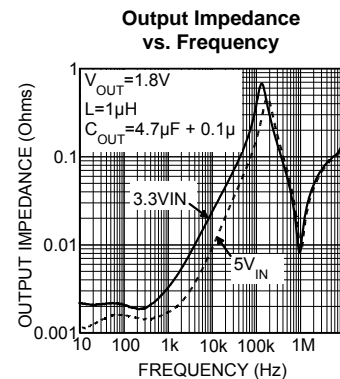

From this graph, you can see the effects of bandwidth and output capacitance. For frequencies <200KHz, the output impedance is dominated by the gain and inductance. For frequencies >200KHz, the output impedance is dominated by the capacitance. A good approximation for transient response can be calculated from determining the frequency of the load step in amps per second;

$$f = \frac{A/sec}{2\pi}$$

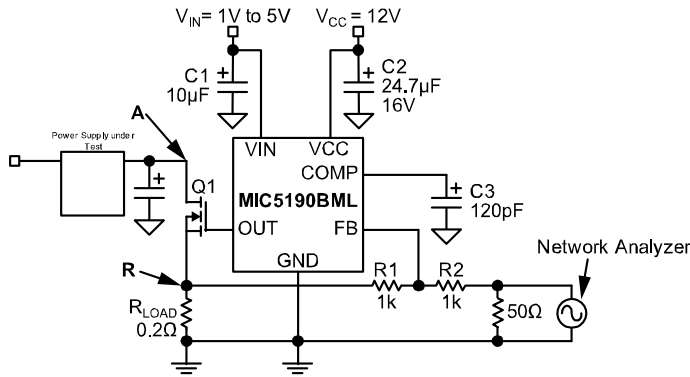

Figure 9. Output Impedance Measurement

Then, determine the output impedance by looking at the output impedance vs frequency graph. Next, calculate the voltage deviation times the load step;

$$\Delta V_{OUT} = \Delta I_{OUT} \times Z_{OUT}$$

The output impedance graph shows the relationship between supply voltage and output impedance. This is caused by the lower R_{dson} of the high side MOSFET and the increase in gain with increased supply voltages. This explains why higher supply voltages have better transient response.

$$\downarrow Z_{TOTAL} = \frac{\downarrow R_{DSON} + DCR + X_L}{\uparrow GAIN} \parallel X_{COUT}$$

Ripple measurements

To properly measure ripple on either input or output of a switching regulator, a proper ring in tip measurement is required. Standard oscilloscope probes come with a grounding clip, or a long wire with an alligator clip. Unfortunately, for high frequency measurements, this ground clip can pick-up high frequency noise and erroneously inject it into the measured output ripple.

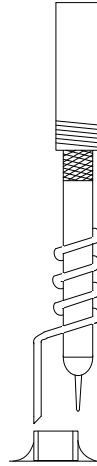

The standard evaluation board accommodates a home made version by providing probe points for both the input and output supplies and their respective grounds. This requires the removing of the oscilloscope probe sheath and ground clip from a standard oscilloscope probe and wrapping a non-shielded bus wire around the oscilloscope probe. If there does not happen to be any non shielded bus wire immediately available, the leads

from axial resistors will work. By maintaining the shortest possible ground lengths on the oscilloscope probe, true ripple measurements can be obtained.

Recommended Layout / 3A Evaluation Board

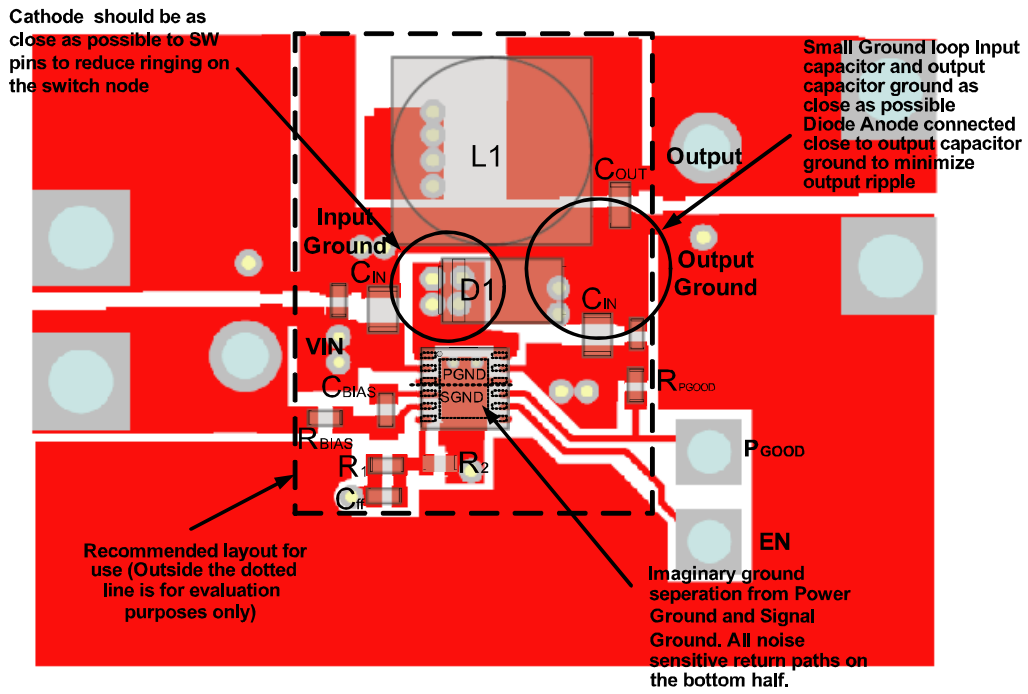

Recommended Top Layout

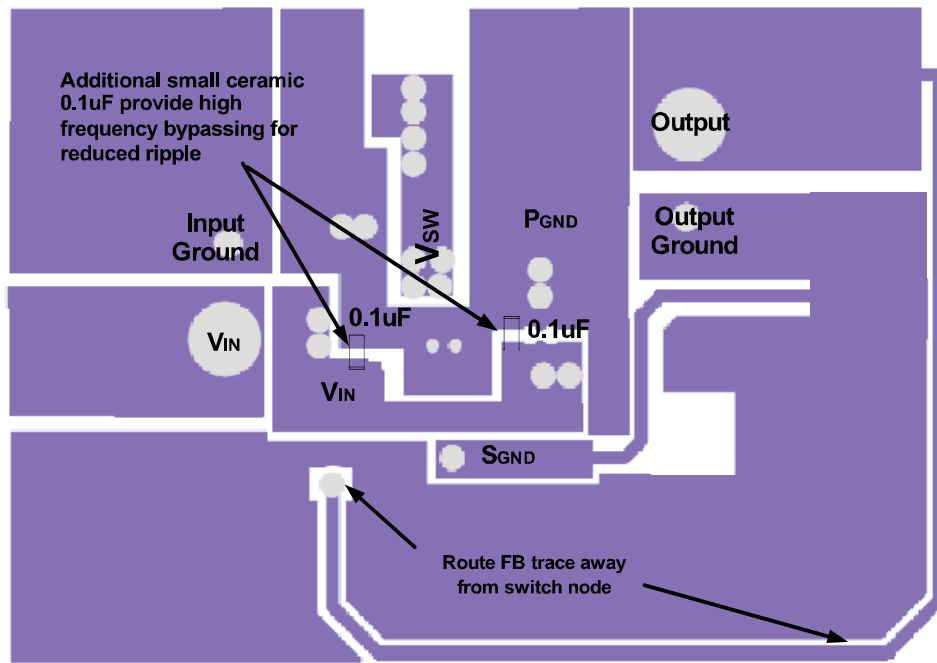

Recommended Bottom Layout

MIC2207 Scheme and B.O.M for 3A Output

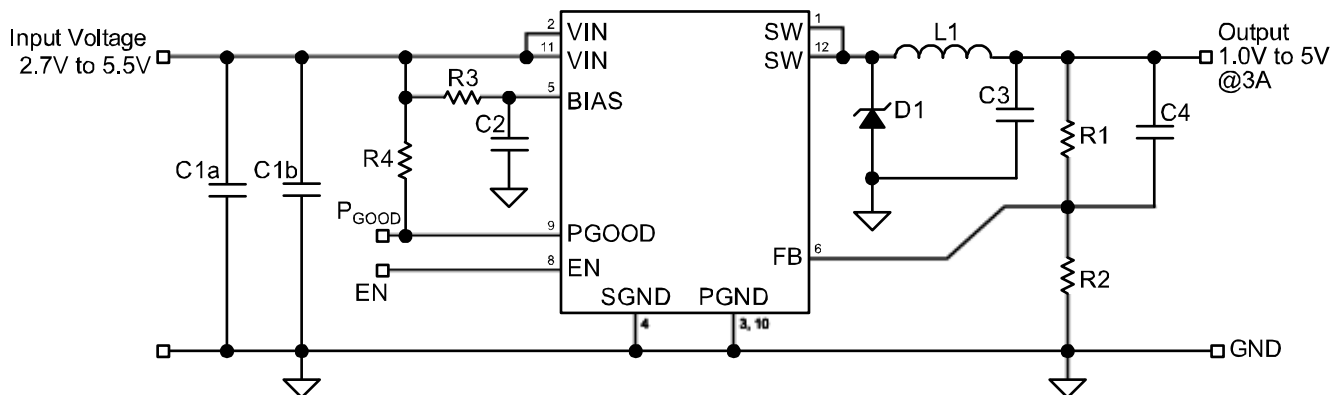

MIC2207 Schematic

| Item | Part Number | Description | Manufacturer | Qty |
|---------|-------------------|---|------------------|-----|
| C1a,C1b | C2012JB0J106K | 10µF Ceramic Capacitor X5R 0805 6.3V | TDK | 2 |
| | GRM219R60J106KE19 | 10µF Ceramic Capacitor X5R 0805 6.3V | Murata | |
| | 08056D106MAT | 10µF Ceramic Capacitor X5R 0805 6.3V | AVX | |
| C2 | 0402ZD104MAT | 0.1µF Ceramic Capacitor X5R 0402 10V | AVX | 1 |
| C3 | C2012JB0J475K | 4.7µF Ceramic Capacitor X5R 0603 6.3V | TDK | 1 |
| | GRM188R60J475KE19 | 4.7µF Ceramic Capacitor X5R 0603 6.3V | Murata | |
| | 06036D475MAT | 4.7µF Ceramic Capacitor X5R 0603 6.3V | AVX | |
| C4 | VJ0402A820KXAA | 82pF Ceramic Capacitor 0402 | Vishay VT | 1 |
| D1 | SSA33L | 3A Schottky 30V SMA | Vishay Semi | 1 |
| L1 | RLF7030-1R0N6R4 | 1µH Inductor 8.8mΩ 7.1mm(L) x 6.8mm (W)x 3.2mm(H) | TDK | 1 |
| | 744 778 9001 | 1µH Inductor 12mΩ 7.3mm(L)x7.3mm(W)x3.2mm(H) | Würth Electronik | 1 |
| | IHLP2525AH-01 1 | 1µH Inductor 17.5mΩ(L)6.47mmx(W)6.86mmx(H) 1.8mm | Vishay Dale | 1 |
| R1,R4 | CRCW04021002F | 10KΩ1% 0402 resistor | Vishay Dale | 1 |
| R2 | CRCW04026651F | 6.65kΩ 1% 0402 For 2.5V _{OUT} | Vishay Dale | 1 |
| | CRCW04021242F | 12.4kΩ 1% 0402 For 1.8 V _{OUT} | Vishay Dale | |
| | CRCW04022002F | 20kΩ 1% 0402 For 1.5 V _{OUT} | Vishay Dale | |
| | CRCW04024022F | 40.2kΩ 1% 0402 For 1.2 V _{OUT} | Vishay Dale | |
| | Open | For 1.0 V _{OUT} | Vishay Dale | |
| R3 | CRCW040210R0F | 10Ω1% 0402 resistor | Vishay Dale | 1 |
| U1 | MIC2207YML | 2MHz 3A Buck Regulator | Micrel | 1 |

Notes:

1. Sumida: www.sumida.com.
2. Murata: www.murata.com.
3. Vishay: www.vishay.com.
4. Micrel, Inc.: www.micrel.com.

Package Information

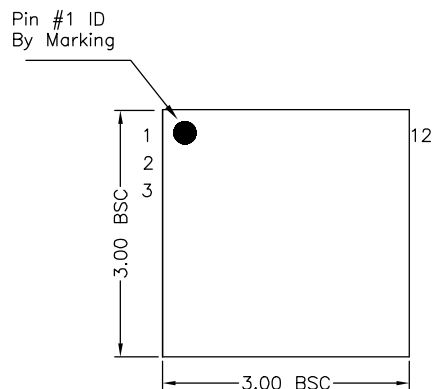

TOP VIEW

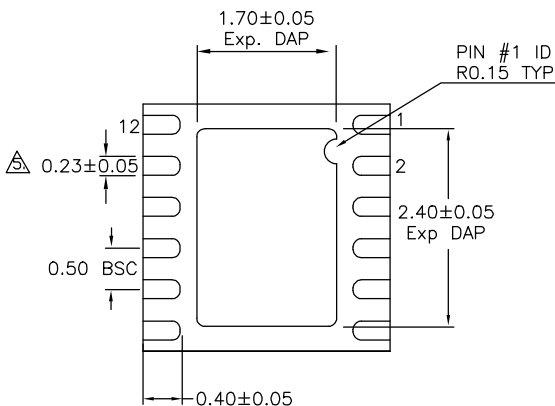

BOTTOM VIEW

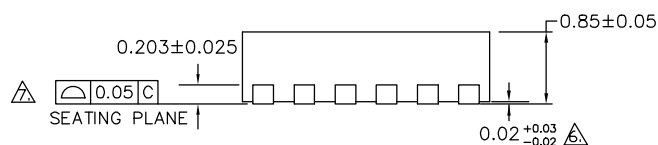

SIDE VIEW

NOTE:

1. ALL DIMENSIONS ARE IN MILLIMETERS.
 2. MAX. PACKAGE WARPAGE IS 0.05 mm.
 3. MAXIMUM ALLOWABLE BURRS IS 0.076 mm IN ALL DIRECTIONS.
 4. PIN #1 ID ON TOP WILL BE LASER/INK MARKED.
- △ DIMENSION APPLIES TO METALIZED TERMINAL AND IS MEASURED BETWEEN 0.20 AND 0.25 mm FROM TERMINAL TIP.
- △ APPLIED ONLY FOR TERMINALS.
- △ APPLIED FOR EXPOSED PAD AND TERMINALS.

12-Pin MLF[®] (ML)

MICREL, INC. 2180 FORTUNE DRIVE SAN JOSE, CA 95131 USA
 TEL +1 (408) 944-0800 FAX +1 (408) 474-1000 WEB <http://www.micrel.com>

The information furnished by Micrel in this data sheet is believed to be accurate and reliable. However, no responsibility is assumed by Micrel for its use. Micrel reserves the right to change circuitry and specifications at any time without notification to the customer.

Micrel Products are not designed or authorized for use as components in life support appliances, devices or systems where malfunction of a product can reasonably be expected to result in personal injury. Life support devices or systems are devices or systems that (a) are intended for surgical implant into the body or (b) support or sustain life, and whose failure to perform can be reasonably expected to result in a significant injury to the user. A Purchaser's use or sale of Micrel Products for use in life support appliances, devices or systems is a Purchaser's own risk and Purchaser agrees to fully indemnify Micrel for any damages resulting from such use or sale.

© 2005 Micrel, Incorporated.

Looking for pricing, stock, or lifecycle information?

Click below to explore more details on WIN SOURCE:

- ⊖ [View MIC2207YML-TR on WIN SOURCE](#)
- ⊖ [Microchip Technology](#) Information

Optimize Your Supply Chain with WIN SOURCE Solutions

- ✓ Global Sourcing Solution
- ✓ Obsolete Management
- ✓ Cost Control Management
- ✓ Shortage Management
- ✓ Alternative Solution
- ✓ Excess Inventory Management