



THE DATASHEET OF MIC2214-KNBML



General Description

The MIC2214 is a dual μ Cap low dropout regulator with an open-drain driver and power-on reset circuit. The first regulator is capable of sourcing 150mA, while the second regulator can source up to 300mA and includes a power-on reset function. The open-drain output is capable of sinking 150mA for LED backlighting applications.

Ideal for battery operated applications, the MIC2214 offers 1% accuracy, extremely low dropout voltage (80mV @ 100mA), and extremely low ground current, only 48 μ A total. Equipped with a TTL-logic-compatible enable pin, the MIC2214 can be put into a zero-off-mode current state, drawing no current when disabled.

The MIC2214 is a μ Cap design, operating with very small ceramic output capacitors for stability, reducing required board space and component cost.

The MIC2214 is available in fixed output voltages in the 10-pin 3mm \times 3mm MLF™ leadless package and is also available with adjustable output voltages in the 4mm \times 4mm 16-pin MLF™ package.

Features

- Input voltage range: 2.25V to 5.5V
- Stable with ceramic output capacitor
- 2 LDO outputs
 - Output 1 – 150mA output current
 - Output 2 – 300mA output current
- 1 Open-drain driver
- Power-on reset function with adjustable delay time
- Low dropout voltage of 80mV @ 100mA
- **Ultra-low quiescent current of 48 μ A**
- High output accuracy:
 - +1.0% initial accuracy
 - +2.0% over temperature
- Thermal shutdown protection
- Current limit protection
- **Tiny 3mm \times 3mm MLF™-10 package**

Applications

- Cellular/PCS phones
- Wireless modems
- PDAs

Typical Application



MIC2214 Typical Cellphone Application

Ordering Information

Full Number	Part Number Manufacturing	Pb-Free	Voltage* (Vo1/Vo2)	Junction Temp. Range	Package
MIC2214-1.5/2.8BML	MIC2214-FMBML	MIC2214-FMYML	1.5V/2.8V	-40°C to +125°C	10-Pin 3x3 MLF™
MIC2214-1.6/2.8BML	MIC2214-WMBML	MIC2214-WMYML	1.6V/2.8V	-40°C to +125°C	10-Pin 3x3 MLF™
MIC2214-1.6/3.0BML	MIC2214-WPBML	MIC2214-WPYML	1.6V/3.0V	-40°C to +125°C	10-Pin 3x3 MLF™
MIC2214-1.6/3.3BML	MIC2214-WSBML	MIC2214-WSYML	1.6V/3.3V	-40°C to +125°C	10-Pin 3x3 MLF™
MIC2214-1.8/2.6BML	MIC2214-GKBML	MIC2214-GKYML	1.8V/2.6V	-40°C to +125°C	10-Pin 3x3 MLF™
MIC2214-1.8/2.7BML	MIC2214-GLBML	MIC2214-GLYML	1.8V/2.7V	-40°C to +125°C	10-Pin 3x3 MLF™
MIC2214-1.8/2.8BML	MIC2214-GMBML	MIC2214-GMYML	1.8V/2.8V	-40°C to +125°C	10-Pin 3x3 MLF™
MIC2214-1.8/2.9BML	MIC2214-GOBML	MIC2214-GOYML	1.8V/2.9V	-40°C to +125°C	10-Pin 3x3 MLF™
MIC2214-1.8/3.0BML	MIC2214-GPBML	MIC2214-GPYML	1.8V/3.0V	-40°C to +125°C	10-Pin 3x3 MLF™
MIC2214-1.8/3.3BML	MIC2214-GSBML	MIC2214-GSYML	1.8V/3.3V	-40°C to +125°C	10-Pin 3x3 MLF™
MIC2214-1.85/2.65BML	MIC2214-DIBML	MIC2214-DIYML	1.85V/2.65V	-40°C to +125°C	10-Pin 3x3 MLF™
MIC2214-1.85/2.6BML	MIC2214-DKBML	MIC2214-DKYML	1.85V/2.6V	-40°C to +125°C	10-Pin 3x3 MLF™
MIC2214-1.85/2.7BML	MIC2214-DLBML	MIC2214-DLYML	1.85V/2.7V	-40°C to +125°C	10-Pin 3x3 MLF™
MIC2214-1.85/2.85BML	MIC2214-DNBML	MIC2214-DNYML	1.85V/2.85V	-40°C to +125°C	10-Pin 3x3 MLF™
MIC2214-1.85/2.9BML	MIC2214-DOBML	MIC2214-DOYML	1.85V/2.9V	-40°C to +125°C	10-Pin 3x3 MLF™
MIC2214-2.5/1.8BML	MIC2214-JGBML	MIC2214-JGYML	2.5V/1.8V	-40°C to +125°C	10-Pin 3x3 MLF™
MIC2214-2.5/2.8BML	MIC2214-JMBML	MIC2214-JMYML	2.5V/2.8V	-40°C to +125°C	10-Pin 3x3 MLF™
MIC2214-2.5/3.0BML	MIC2214-JPBML	MIC2214-JPYML	2.5V/3.0V	-40°C to +125°C	10-Pin 3x3 MLF™
MIC2214-2.5/3.1BML	MIC2214-JQBML	MIC2214-JQYML	2.5V/3.1V	-40°C to +125°C	10-Pin 3x3 MLF™
MIC2214-2.6/2.6BML	MIC2214-KKBML	MIC2214-KKYML	2.6V/2.6V	-40°C to +125°C	10-Pin 3x3 MLF™
MIC2214-2.6/2.85BML	MIC2214-KNBML	MIC2214-KNYML	2.6V/2.85V	-40°C to +125°C	10-Pin 3x3 MLF™
MIC2214-2.6/2.8BML	MIC2214-KMBML	MIC2214-KMYML	2.6V/2.8V	-40°C to +125°C	10-Pin 3x3 MLF™
MIC2214-2.6/3.0BML	MIC2214-KPBML	MIC2214-KPYML	2.6V/3.0V	-40°C to +125°C	10-Pin 3x3 MLF™
MIC2214-2.7/2.8BML	MIC2214-LMBML	MIC2214-LMYML	2.7V/2.8V	-40°C to +125°C	10-Pin 3x3 MLF™
MIC2214-2.7/3.0BML	MIC2214-LPBML	MIC2214-LPYML	2.7V/3.0V	-40°C to +125°C	10-Pin 3x3 MLF™
MIC2214-2.8/2.8BML	MIC2214-MMBML	MIC2214-MMYML	2.8V/2.8V	-40°C to +125°C	10-Pin 3x3 MLF™
MIC2214-2.8/3.0BML	MIC2214-MPBML	MIC2214-MPYML	2.8V/3.0V	-40°C to +125°C	10-Pin 3x3 MLF™
MIC2214-2.85/2.85BML	MIC2214-NNBML	MIC2214-NNYML	2.85V/2.85V	-40°C to +125°C	10-Pin 3x3 MLF™
MIC2214-3.0/1.6BML	MIC2214-PWBML	MIC2214-PWYML	3.0V/1.6V	-40°C to +125°C	10-Pin 3x3 MLF™
MIC2214-3.0/2.85BML	MIC2214-PNBML	MIC2214-PNYML	3.0V/2.85V	-40°C to +125°C	10-Pin 3x3 MLF™
MIC2214-3.0/2.8BML	MIC2214-PMBML	MIC2214-PMYML	3.0V/2.8V	-40°C to +125°C	10-Pin 3x3 MLF™
MIC2214-3.0/3.3BML	MIC2214-PSBML	MIC2214-PSYML	3.0V/3.3V	-40°C to +125°C	10-Pin 3x3 MLF™
MIC2214-3.3/1.6BML	MIC2214-SWBML	MIC2214-SWYML	3.3V/1.6V	-40°C to +125°C	10-Pin 3x3 MLF™
MIC2214-3.3/1.8BML	MIC2214-SGBML	MIC2214-SGYML	3.3V/1.8V	-40°C to +125°C	10-Pin 3x3 MLF™
MIC2214-3.3/2.8BML	MIC2214-SMBML	MIC2214-SMYML	3.3V/2.8V	-40°C to +125°C	10-Pin 3x3 MLF™
MIC2214-Adj/AdjBML	MIC2214-AABML	MIC2214-AAYML	Adj/Adj	-40°C to +125°C	16-Pin 4x4 MLF™

* Contact factory regarding availability for voltages not listed

Voltage	Code
Adj	A
1.5	F
1.6	W
1.8	G
1.85	D
1.9	Y
2.0	H
2.1	E
2.5	J
2.6	K
2.65	I

Voltage	Code
2.7	L
2.8	M
2.850	N
2.9	O
3.0	P
3.1	Q
3.2	R
3.3	S
3.4	T
3.5	U
3.6	V

Table 1. Voltage Codes

Pin Configuration



10-Pin 3mm × 3mm MLF™ (ML)
(Top View)



16-Pin 4mm × 4mm MLF™ (ML)

Pin Description

Pin Number MLF-10 (3x3)	Pin Number MLF-16 (4x4)	Pin Name	Pin Function
1	15, 16	VIN	Supply Input: (VIN1 and VIN2 are internally tied together)
2	–	EN	Enable Input: Enables both regulator outputs. Active High. High = on, low = off. Do not leave floating.
–	1	EN1	Enable Input to Regulator 1: Enables regulator 1 output. Active high input. High = on, low = off. Do not leave floating.
–	2	EN2	Enable Input to Regulator 2: Enables regulator 2 output. Active high input. High = on, low = off. Do not leave floating.
3	3	CBYP	Reference Bypass: Connect external 0.01μF to GND to reduce output noise. May be left open.
4	5	SW	Active high signal drives open-drain N-Channel MOSFET.
–	4	ADJ1	Adjust Input (Regulator 1): Connect feedback resistors to program the output voltage for the regulator.
5	6	SET	Delay Set Input: Connect external capacitor to GND to set the internal delay for the POR output. When left open, there is no delay. This pin cannot be grounded.
6	7,8	GND	Ground: Connect externally to exposed pad.
–	9	NGND	Ground for the open-drain driver. Tied to the source of the NMOSFET. Tied to GND internally.
–	10	ADJ2	Adjust Input (Regulator 2): Connect feedback resistors to program the output voltage for the regulator.
7	11	DRV	Open-Drain Output: Capable of sinking 150mA.
8	12	POR	Power-On Reset Output: Open-drain output. Active low indicates an output undervoltage condition on regulator 2.
9	13	VOUT2	Output of Regulator 2: 300mA output current
10	14	VOUT1	Output of Regulator 1: 150mA output current
EP	EP	GND	Ground: Internally connected to the exposed pad. Connect externally to ground pin.

Absolute Maximum Rating (Note 1)

Supply Input Voltage (V_{IN}).....	0V to 7V
Enable Input Voltage (V_{EN})	0V to 7V
Power Dissipation (P_D).....	Internally Limited, Note 3
Junction Temperature.....	-40°C to +125°C
Storage Temperature (T_S)	-65°C to 150°C
Open-Drain Output (DRV)	250mA
Lead Temperature (soldering, 5 sec.).....	260°C

Operating Ratings (Note 2)

Supply Input Voltage (V_{IN}).....	2.25V to 5.5V
Enable Input Voltage (V_{EN})	0V to V_{in}
Junction Temperature (T_J).....	-40°C to +125°C
Package Thermal Resistance	
MLF™-10 (θ_{JA}) 1" square 2 oz. copper.....	60°C/W

Electrical Characteristics (Note 4)

$V_{IN} = V_{OUT} + 1.0V$ for higher output of the regulator pair; $C_{OUT} = 1.0\mu F$, $I_{OUT} = 100\mu A$; $T_J = 25^\circ C$, **bold** values indicate $-40^\circ C \leq T_J \leq +125^\circ C$; unless noted.

Parameter	Conditions	Min	Typ	Max	Units
Output Voltage Accuracy	Variation from nominal V_{OUT}	-1.0 -2.0		+1.0 +2.0	% %
Output Voltage Temp. Coefficient			40		ppm/C
Line Regulation; Note 5	$V_{IN} = V_{OUT} + 1V$ to 5.5V	-0.3 -0.6	0.02	0.3 0.6	%/V
Load Regulation	$I_{OUT} = 100\mu A$ to 150mA (Regulator 1 and 2)		0.2	1.0	%
	$I_{OUT} = 100\mu A$ to 300mA (Regulator 2)			1.5	%
Dropout Voltage; Note 6	$I_{OUT} = 150mA$ (Regulator 1 and 2)		120	190 250	mV mV
	$I_{OUT} = 300mA$ (Regulator 2)		240	340 420	mV
Ground Pin Current	$I_{OUT1} = I_{OUT2} = 0\mu A$		48	65 80	μA μA
	$I_{OUT1} = 150mA$ & $I_{OUT2} = 300mA$		60		μA
Ground Pin Current in Shutdown	$V_{EN} \leq 0.4V$			2.0	μA
Ripple Rejection	$f = 1kHz$; $C_{OUT} = 1.0\mu F$ ceramic; $C_{BYP} = 10nF$		60		dB
	$f = 20kHz$; $C_{OUT} = 1.0\mu F$ ceramic; $C_{BYP} = 10nF$		40		dB
Current Limit	$V_{OUT} = 0V$ (Regulator 1)	150	280	460	mA
	$V_{OUT} = 0V$ (Regulator 2)	300	450	700	mA
Output Voltage Noise	$C_{OUT} = 1\mu F$, $C_{BYP} = 0.01\mu F$, 10Hz to 100kHz		30		μV_{rms}

Enable Input

Enable Input Voltage	Logic Low (Regulator Shutdown)			0.6	V
	Logic High (Regulator Enabled)	1.8			V
Enable Input Current	$V_{IL} < 0.6V$ (Regulator Shutdown)	-1	0.01	+1	μA
	$V_{IH} > 1.8V$ (Regulator Enabled)	-1	0.01	+1	μA

POR Output

V_{TH}	Low Threshold, % of nominal V_{OUT2} (Flag ON)	90			%
	High Threshold, % of nominal V_{OUT2} (Flag OFF)			96	%
V_{OL}	POR output logic low voltage; $I_L = 250\mu A$		0.02	0.1	V
I_{POR}	Flag leakage current, flag OFF	-1	0.01	+1	μA

Parameter	Conditions	Min	Typ	Max	Units
DRV Output					
Voltage Low	$I_{DRV} = 150\text{mA}$		0.2	0.5 0.6	V
Leakage Current	$I_{DRV} = 0\text{mA}$, $V_{DRV} = 5.5\text{V}$, $SW = 0\text{V}$	-1	0.01	+1	μA
SW Input Voltage	Logic Low (DRV shutdown)			0.6	V
	Logic High (DRV enabled)	1.8			V
SW Input Current	$V_{IL} < 0.6\text{V}$ (DRV shutdown)	-1	0.01	+1	μA
	$V_{IH} > 1.8\text{V}$ (DRV enabled)	-1	0.01	+1	μA
SET Input					
SET Pin Current Source	$V_{SET} = 0\text{V}$	0.75	1.25	1.75	μA
SET Pin Threshold Voltage	$P_{OR} = \text{High}$		1.25		V

Note 1. Exceeding maximum rating may damage the device.

Note 2. The device is not guaranteed to work outside its operating rating.

Note 3. The maximum allowable power dissipation of any T_A (ambient temperature) is $(P_{D(max)} = T_{J(max)} - T_A) / \theta_{JA}$. Exceeding the maximum allowable power dissipation will result in excessive die temperature, and the regulator will go into thermal shutdown.

Note 4. Specification for packaged product only.

Note 5. Minimum input for line regulation test is set to $V_{OUT} + 1\text{V}$ relative to the highest output voltage.

Note 6. Dropout voltage is defined as the input-to-output differential at which the output voltage drops 2% below its nominal value measured at 1V differential. For outputs below 2.25V, dropout voltage is the input-to-output voltage differential with the minimum input voltage 2.25V. Minimum input operating voltage is 2.25V.

Typical Characteristics



Typical Characteristics (cont.)

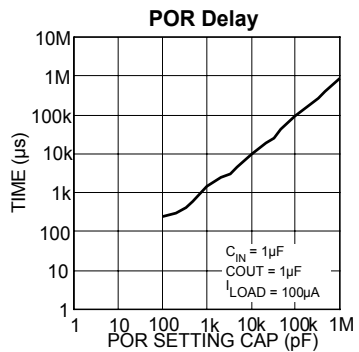
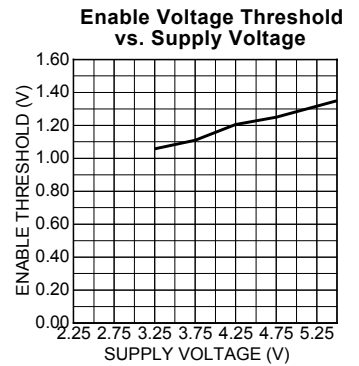
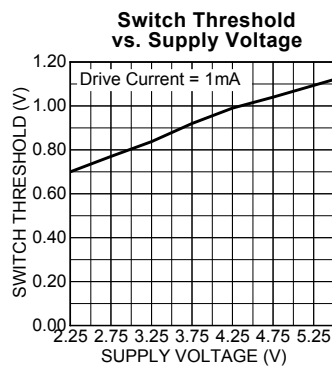
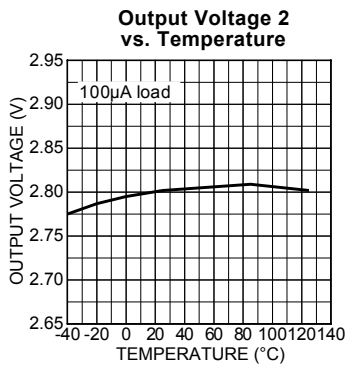
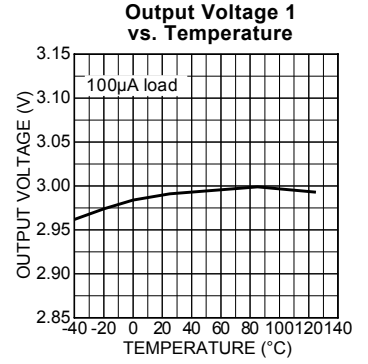
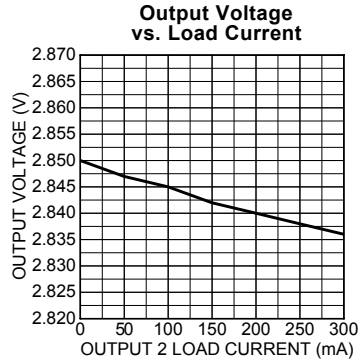
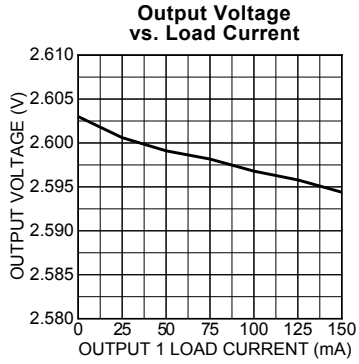

Functional Characteristics

Enable Characteristics

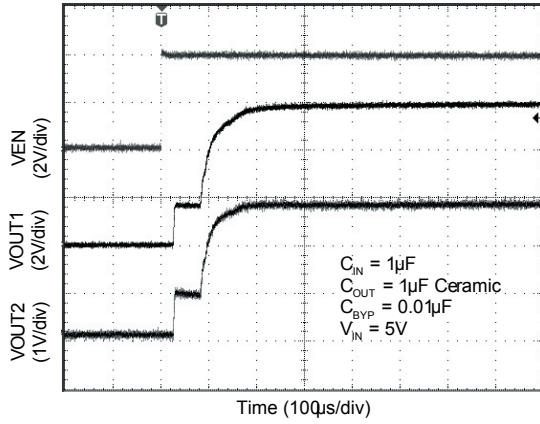

Power-On Reset Characteristics

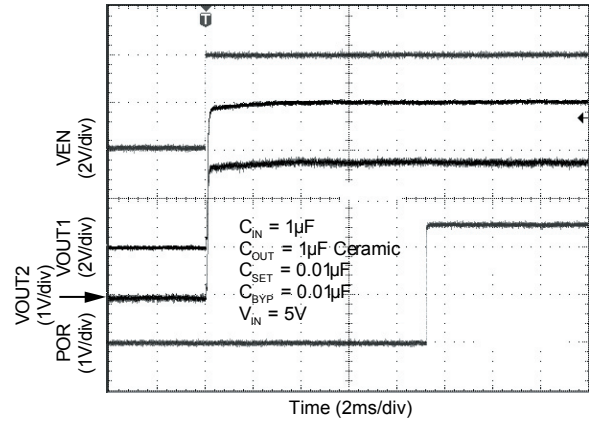

Load Transient Response (LDO 1)

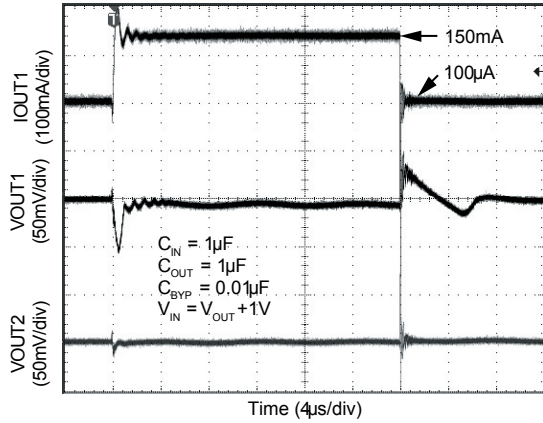

Load Transient Response (LDO 2)

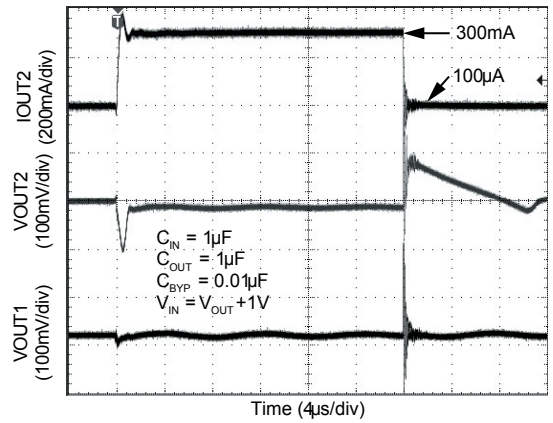

Functional Diagram



MIC2214 Fixed Voltage Block Diagram



MIC2214 Adjustable Voltage Block Diagram

Functional Description

The MIC2214 is a high performance, low quiescent current power management IC consisting of two μ Cap low dropout regulators, a power-on reset (POR) circuit and an open-drain driver. The first regulator is capable of sourcing 150mA at output voltages from 1.25V to 5V. The second regulator is capable of sourcing 300mA of current at output voltages from 1.25V to 5V. The second regulator has a POR circuit that monitors its output voltage and indicates when the output voltage is within 5% of nominal. The POR offers a delay time that is externally programmable with a single capacitor to ground. An open-drain driver completes the power management chipset, offering the capability of driving LEDs for keypad backlighting in applications such as cellphones.

Enable

The enable input allows for logic control of both output voltages with one enable input. The enable input is active high, requiring 1.8V for guaranteed operation. The enable input is CMOS logic and cannot be left floating.

Power-On Reset (POR)

The power-on reset output is an open-drain N-Channel device, requiring a pull-up resistor to either the input voltage or output voltage for proper voltage levels. The POR output has a delay time that is programmable with a capacitor from the SET pin to ground. The delay time can be programmed to be as long as 1 second.

The SET pin is a current source output that charges a capacitor that sets the delay time for the power-on reset output. The current source is a $1\mu\text{A}$ current source that charges a capacitor up from 0V. When the capacitor reaches 1.25V, the output of the POR is allowed to go high.

Open-Drain Driver (DRV)

The drive (DRV) pin is an open-drain output capable of sinking 150mA of current. This output is controlled by a logic level input, the switch (SW) pin. The switch pin is an active high input and cannot be left floating.

Input Capacitor

Good bypassing is recommended from input to ground to help improve AC performance. A 1 μ F capacitor or greater located close to the IC is recommended.

Bypass Capacitor

The internal reference voltage of the MIC2214 can be bypassed with a capacitor to ground to reduce output noise and increase power supply rejection (PSRR). A quick-start feature allows for quick turn-on of the output voltage regardless of the size of the capacitor. The recommended nominal bypass capacitor is 0.01 μ F, but it can be increased without limit.

Output Capacitor

Each regulator output requires a 1 μ F ceramic output capacitor for stability. The output capacitor value can be increased to improve transient response, but performance has been optimized for a 1 μ F ceramic type output capacitor.

X7R/X5R dielectric-type ceramic capacitors are recommended because of their temperature performance. X7R-type capacitors change capacitance by 15% over their operating temperature range and are the most stable type of ceramic capacitors. Z5U and Y5V dielectric capacitors change value by as much as 50% and 60% respectively over their operating temperature ranges. To use a ceramic chip capacitor with Y5V dielectric, the value must be much higher than an X7R ceramic capacitor to ensure the same minimum capacitance over the equivalent operating temperature range.

Adjustable Regulator Design



MIC2214 Adjustable Regulator Design

The MIC2214 allows the programming of the output voltages 1 and 2 anywhere between 1.25V and 5.5V, the maximum operating rating of the part. Two resistors are required for each output. Appropriate resistor values are required to prevent the low quiescent current performance being compromised. Resistor values recommended are between 100k Ω and 500k Ω .

The resistor values are calculated by:

$$R1 = R2 \left(\frac{V_{OUT}}{1.250} - 1 \right)$$

where V_{OUT} is the desired output voltage. Calculate separately for each output.

Package Information

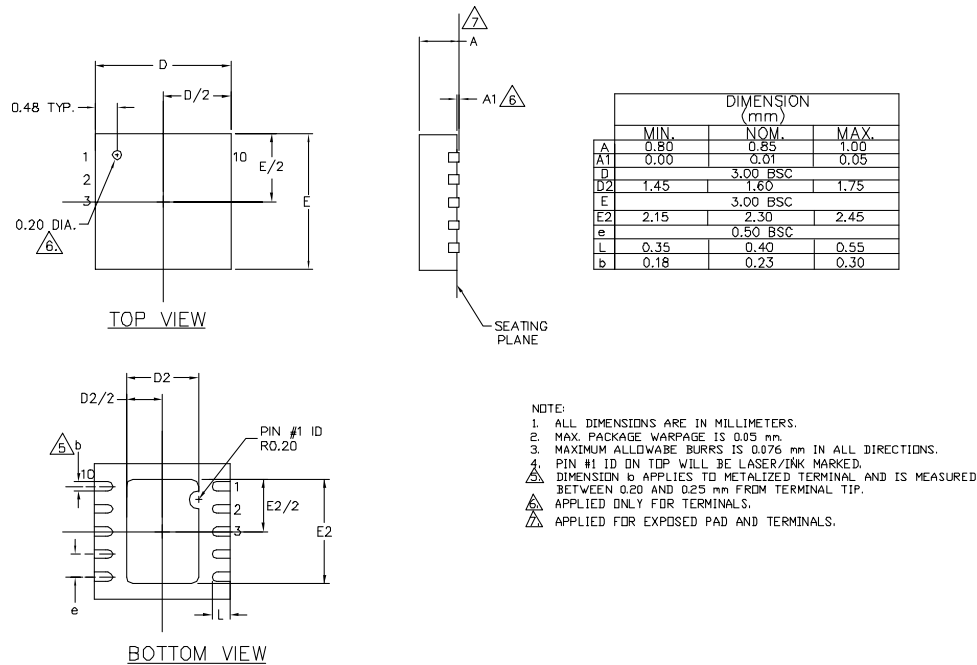

10-Lead MLF™ (ML)



16-Lead MLF™ (ML)

MICREL INC. 2180 FORTUNE DRIVE SAN JOSE, CA 95131 USA
TEL + 1 (408) 944-0800 FAX + 1 (408) 474-1000 WEB <http://www.micrel.com>

This information furnished by Micrel in this data sheet is believed to be accurate and reliable. However no responsibility is assumed by Micrel for its use. Micrel reserves the right to change circuitry and specifications at any time without notification to the customer.

Micrel Products are not designed or authorized for use as components in life support appliances, devices or systems where malfunction of a product can reasonably be expected to result in personal injury. Life support devices or systems are devices or systems that (a) are intended for surgical implant into the body or (b) support or sustain life, and whose failure to perform can be reasonably expected to result in a significant injury to the user. A Purchaser's use or sale of Micrel Products for use in life support appliances, devices or systems is a Purchaser's own risk and Purchaser agrees to fully indemnify Micrel for any damages resulting from such use or sale.

© 2003 Micrel, Incorporated.

Looking for pricing, stock, or lifecycle information?

Click below to explore more details on WIN SOURCE:

- ⊖ [View MIC2214-KNBML on WIN SOURCE](#)
- ⊖ [Microchip Technology](#) Information

Optimize Your Supply Chain with WIN SOURCE Solutions

- ✓ Global Sourcing Solution
- ✓ Obsolete Management
- ✓ Cost Control Management
- ✓ Shortage Management
- ✓ Alternative Solution
- ✓ Excess Inventory Management