

Dual Synchronous 800 mA/800 mA Step-Down DC/DC Regulator

Features

- High Efficiency: Over 96%
- Ultra-Low Quiescent Current: Only 28 μA
- Ultra-Low Shutdown Current: Less Than 1 μA
- Fast Transient Performance
- 2.5 MHz PWM Operation
- High Output Current Capability per Channel: 800 mA
- No Schottky Diodes Required
- Stable with 2.2 μH Inductor, 10 μF Ceramic Capacitor
- Adjustable Output Voltage Down to 0.8V
- Built-In Soft-Start Circuitry
- Current-Limit Protection
- Automatic Switching into Light Load Mode Operation
- /FPWM Pin allows Low-Noise Forced PWM Mode Operation
- Power Good Output with Internal 5 μA Current Source allows Sequencing with Programmable Delay Time
- Small Thermally Enhanced 3 mm \times 3 mm TDFN-12L Package

Applications

- MPU & ASIC Power
- PDAs
- Digital Cameras
- PC Cards
- Wireless and DSL Modems

General Description

The MIC2230 is a dual output, high-efficiency synchronous step-down DC/DC converter. The MIC2230 is ideally suited for portable and embedded systems that demand high power conversion efficiencies and fast transient performance, while offered in a very small package. The MIC2230 offers an ultra-low quiescent current in light load mode, assuring minimum current draw from battery powered applications in standby modes. The MIC2230 was designed to only require miniature 2.2 μH inductors and 10 μF ceramic capacitors.

The MIC2230 features a selectable mode that allows the user to trade-off lowest noise performance for low power efficiency. Trickle mode operation provides ultra-high efficiency at light loads, while PWM operation provides very low ripple noise performance. To maximize battery life in low-dropout conditions, MIC2230 can operate with a maximum duty cycle of 100%.

The MIC2230 is available in a space-saving 3 mm \times 3 mm TDFN-12L package with a junction temperature range from -40°C to $+125^{\circ}\text{C}$.

Package Types

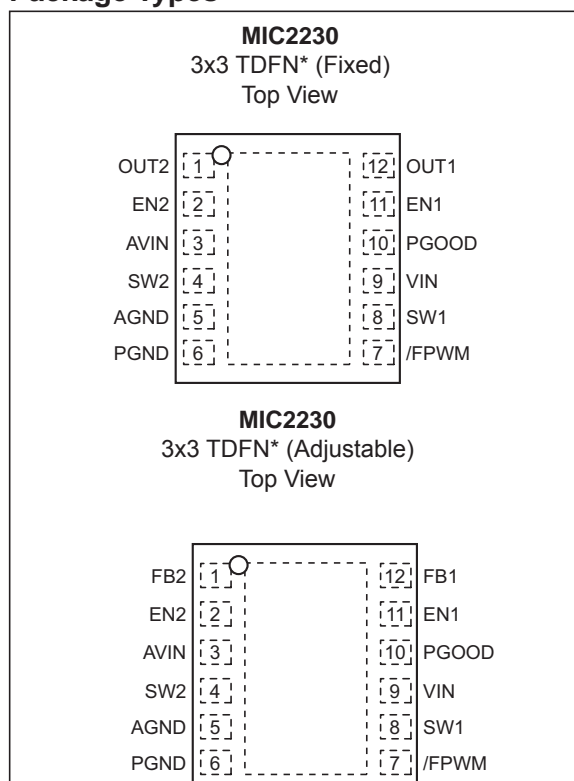

MIC2230

Typical Application Circuit

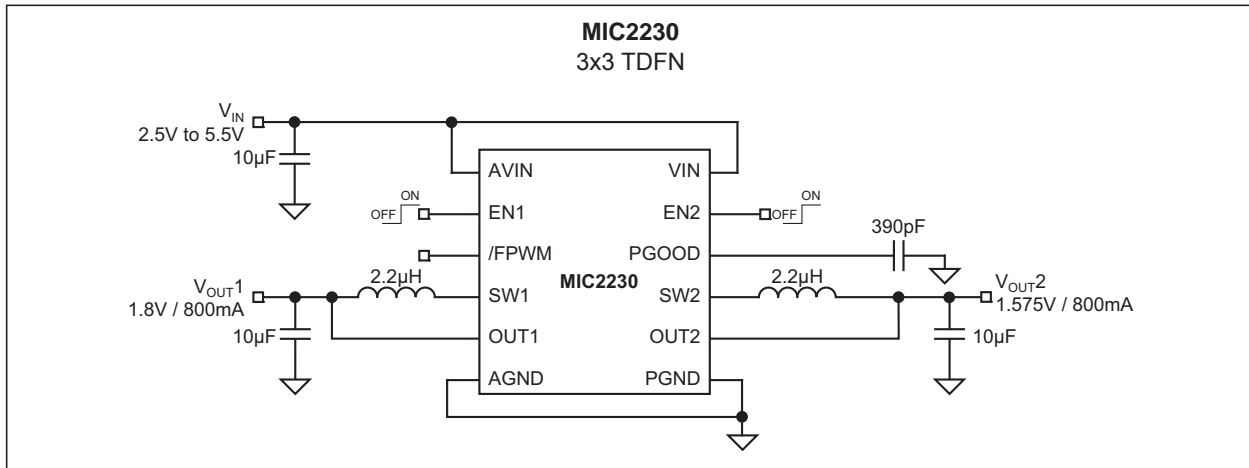

Functional Block Diagram

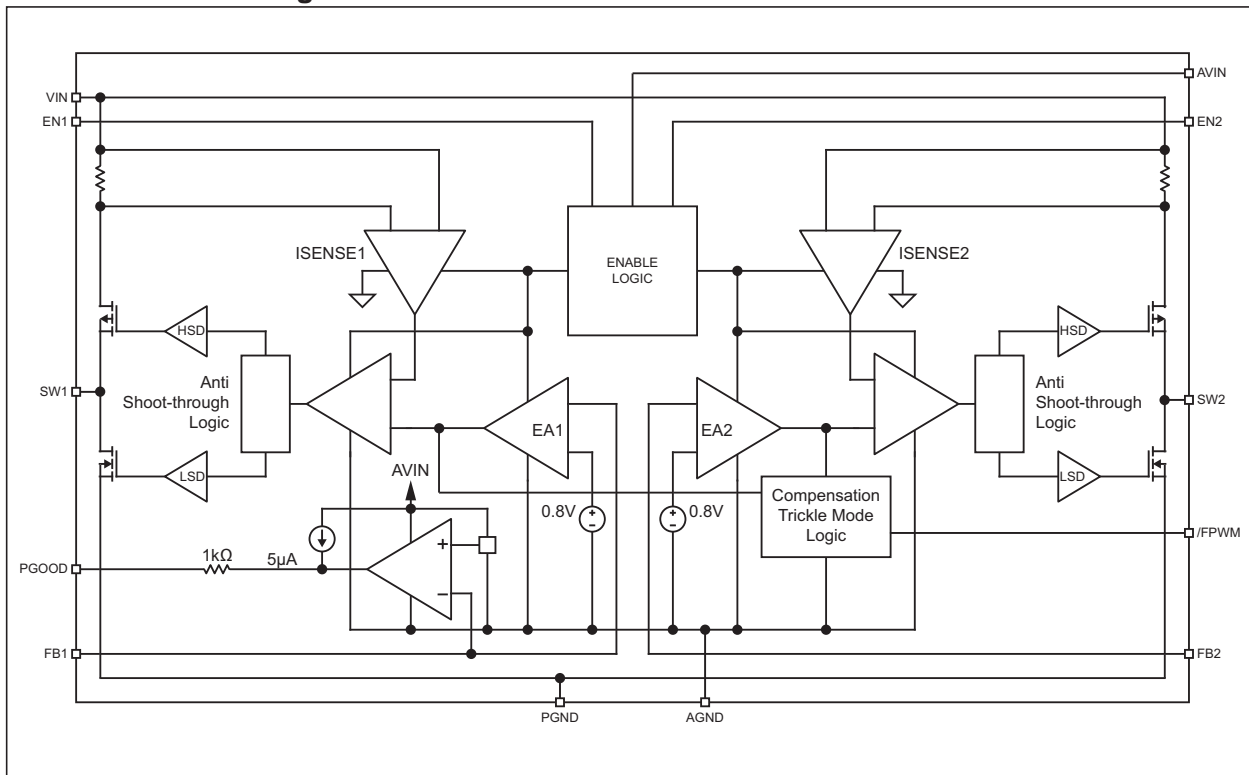

1.0 ELECTRICAL CHARACTERISTICS

Absolute Maximum Ratings †

Supply Voltage, (V_{IN})	+6V
Enable 1 Voltage	+6V
Enable 2 Voltage	+6V
Logic Input Voltage, (V_{EN} , V_{FPWM})	0V to V_{IN}
ESD Protection	+2 kV

Operating Ratings ††

Supply Voltage, V_{IN}	+2.5V to 5.5V
--------------------------------	---------------

† Notice: Exceeding the absolute maximum rating may damage the device.

†† Notice: The device is not guaranteed to function outside its operating rating.

DC CHARACTERISTICS (Note 1)

Electrical Characteristics: Unless otherwise indicated, $T_A = 25^\circ\text{C}$ with $V_{IN} = V_{EN1} = V_{EN2} = 3.6\text{V}$, V_{OUT1} , V_{OUT2} : $L = 2.2 \mu\text{H}$, $C = 10 \mu\text{F}$. **Bold** values indicate $-40^\circ\text{C} \leq T_J \leq +125^\circ\text{C}$.

Parameters	Sym.	Min.	Typ.	Max.	Units	Conditions
Supply Voltage and Current						
Supply Voltage Range		2.5	—	5.5	V	—
UVLO (Rising)		2.3	2.4	2.5	V	—
UVLO Hysteresis		—	100	—	mV	—
PWM Mode Supply Current		—	560	950	μA	/FPWM = Low; V_{OUT1} , $V_{OUT2} = 1.03 * V_{NOM}$ (not switching)
Trickle Mode Supply Current		—	28	50	μA	/FPWM = High; V_{OUT1} , $V_{OUT2} = 1.03 * V_{NOM}$ (not switching)
Shutdown Quiescent Current		—	0.1	1	μA	$V_{EN} = 0\text{V}$
Output Voltage Accuracy						
Feedback Voltage, V_{FB}		0.780	0.8	0.820	V	Adjustable
Output Voltage, V_{OUT}		-2.5	—	+2.5	%	Fixed Output Options
Feedback Bias Current		—	10	—	nA	—
Output Voltage Line Regulation		—	0.1	0.5	%	$2.5\text{V} \leq V_{IN} \leq 5.5\text{V}$
Output Voltage Load Regulation		—	0.5	—	%	$V_{IN} = 5\text{V}$, $I_{OUT} = 10 \text{ mA}$ to 800 mA , /FPWM = 0V $V_{IN} = 3\text{V}$, $I_{OUT} = 10 \text{ mA}$ to 800 mA , /FPWM = 0V
Ripple in Trickle Mode		—	40	—	mV	$V_{IN} = 3.6\text{V}$; $I_{OUT} = 1 \text{ mA}$; $C_{OUT} = 10 \mu\text{F}$, $L = 2.2 \mu\text{H}$.

Note 1: Specification for packaged product only.

MIC2230

DC CHARACTERISTICS (Note 1) (CONTINUED)

Electrical Characteristics: Unless otherwise indicated, $T_A = 25^\circ\text{C}$ with $V_{IN} = V_{EN1} = V_{EN2} = 3.6\text{V}$, V_{OUT1} , V_{OUT2} : $L = 2.2\ \mu\text{H}$, $C = 10\ \mu\text{F}$. **Bold values indicate $-40^\circ\text{C} \leq T_J \leq +125^\circ\text{C}$.**

Parameters	Sym.	Min.	Typ.	Max.	Units	Conditions
Logic Inputs						
EN Input Threshold		—	0.8	1.2	V	On
		0.3	0.7	—	V	Off
EN Input Current		—	0.01	1	μA	—
/FPWM Input Threshold		—	—	$0.6 \times V_{IN}$	V	On
		$0.3 \times V_{IN}$	—	—	V	Off
/FPWM Input Current		—	0.01	1	μA	—
Protection						
Current-Limit		0.9	1.2	1.8	A	—
Control						
Maximum Duty Cycle		100	—	—	%	—
Oscillator						
PWM Mode Frequency		2.125	2.5	2.875	MHz	—
Power Good						
Power Good Reset Threshold		—	6.25	12	%	Upper Threshold
		-14	-8.5	—	%	Lower Threshold
PGOOD Series Resistance		—	1	1.4	k Ω	—
PGOOD Pull-Up Current		—	5	—	μA	Output within 8.5% of regulation
Power Switch						
Switch On-Resistance		—	0.4	—	Ω	$I_{SW} = 150\ \text{mA}$ (PFET)
		—	0.35	—	Ω	$I_{SW} = 150\ \text{mA}$ (NFET)

Note 1: Specification for packaged product only.

TEMPERATURE SPECIFICATIONS (Note 1)

Parameters	Sym.	Min.	Typ.	Max.	Units	Conditions
Temperature Ranges						
Storage Temperature Range	T_A	-65	—	+150	°C	—
Junction Operating Temperature	T_J	-40	—	+125	°C	—
Package Thermal Resistances						
Thermal Resistance, 3 x 3 QFN-12Ld	θ_{JA}	—	60	—	°C/W	—
	θ_{JC}	—	15	—	°C/W	—

Note 1: The maximum allowable power dissipation is a function of ambient temperature, the maximum allowable junction temperature and the thermal resistance from junction to air (i.e., T_A , T_J , θ_{JA}). Exceeding the maximum allowable power dissipation will cause the device operating junction temperature to exceed the maximum +125°C rating. Sustained junction temperatures above +125°C can impact the device reliability.

MIC2230

2.0 TYPICAL PERFORMANCE CURVES

Note: The graphs and tables provided following this note are a statistical summary based on a limited number of samples and are provided for informational purposes only. The performance characteristics listed herein are not tested or guaranteed. In some graphs or tables, the data presented may be outside the specified operating range (e.g., outside specified power supply range) and therefore outside the warranted range.

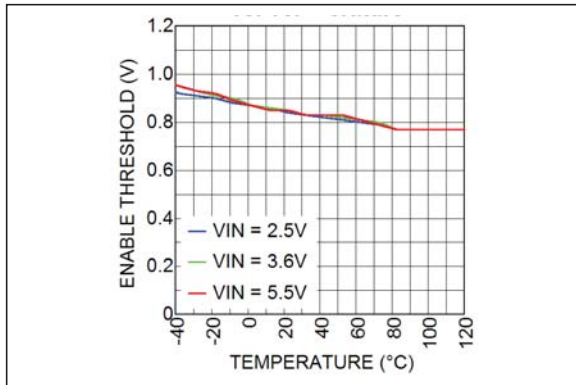

FIGURE 2-1: Enabled Threshold vs. Temperature.

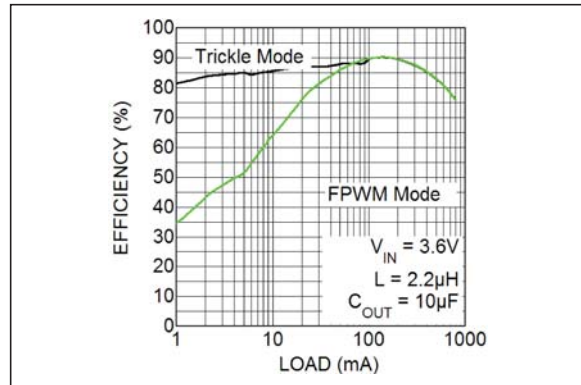

FIGURE 2-4: MIC2230 Efficiency
 $V_{OUT} = 1.575V$.

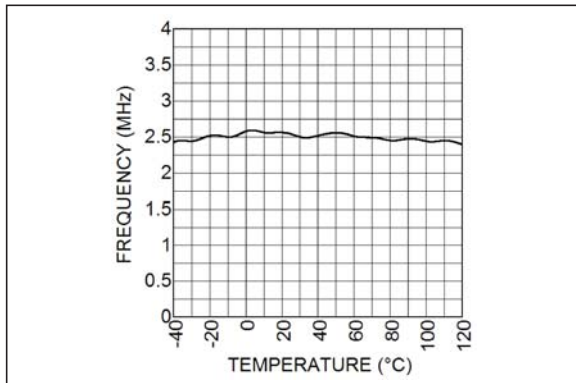

FIGURE 2-2: Frequency vs. Temperature.

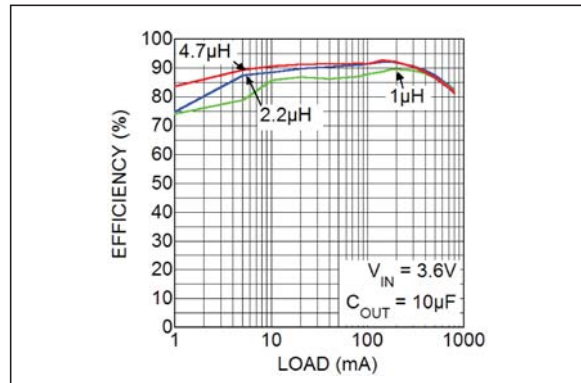

FIGURE 2-5: MIC2230 Efficiency
 $V_{OUT} = 1.8V$.

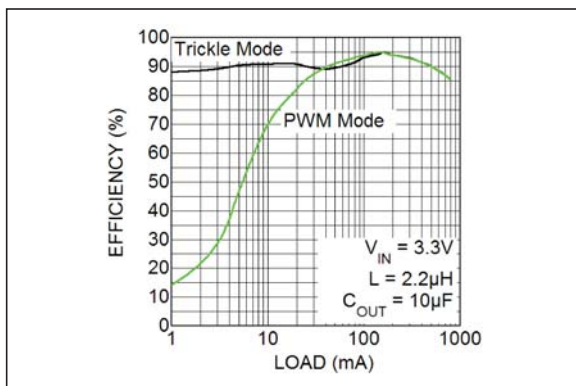

FIGURE 2-3: Efficiency.

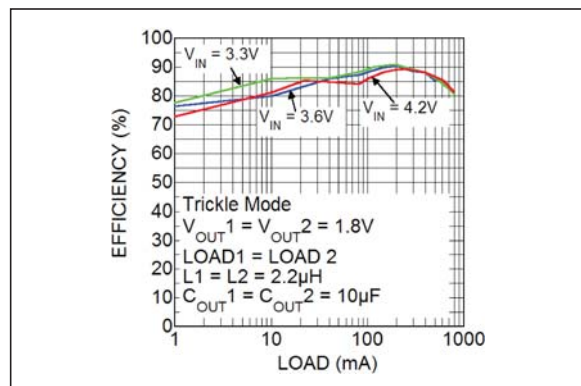

FIGURE 2-6: MIC2230 Efficiency
 $V_{OUT1} = V_{OUT2} = 1.8V$.

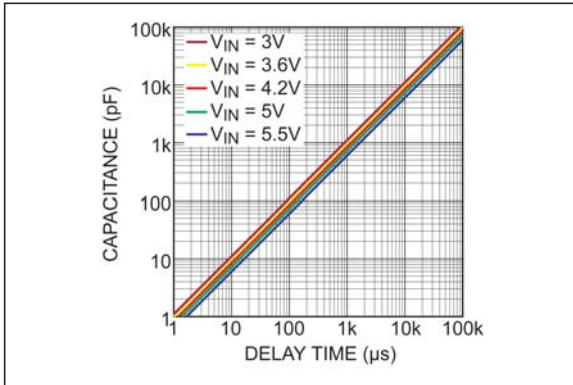

FIGURE 2-7: Capacitance vs. Delay Time.

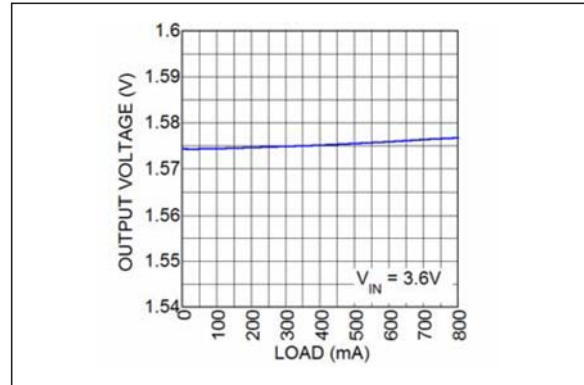

FIGURE 2-10: Output Voltage vs. Load.

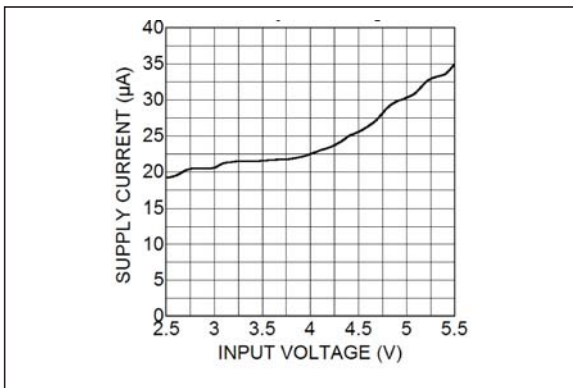

FIGURE 2-8: Trickle Mode Current vs. Input Voltage.

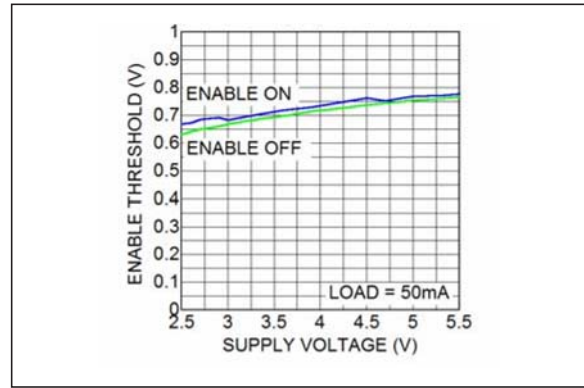

FIGURE 2-11: Enable Threshold vs. Supply Voltage.

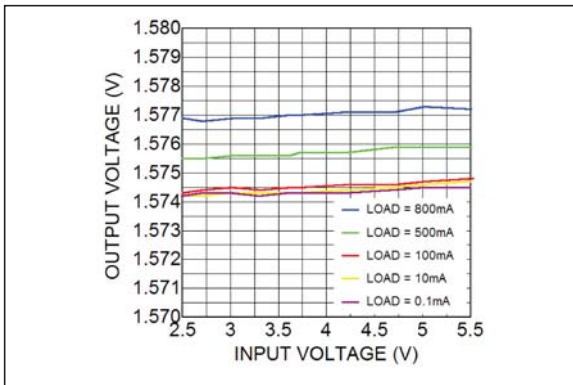

FIGURE 2-9: Output Voltage vs. Input Voltage.

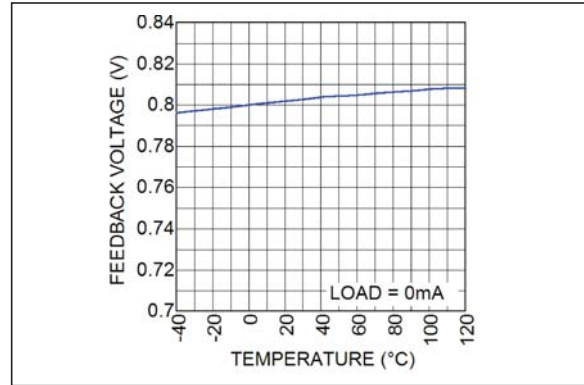

FIGURE 2-12: Feedback Voltage vs. Temperature.

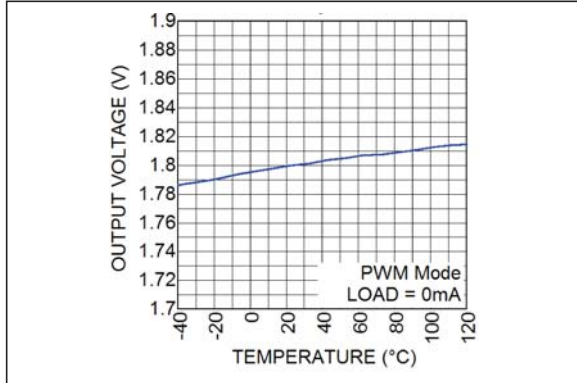

FIGURE 2-13: Output Voltage vs. Temperature.

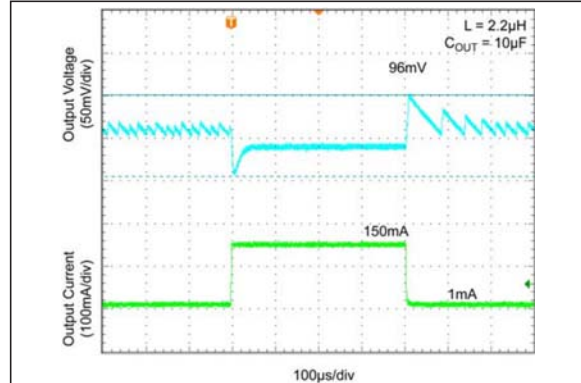

FIGURE 2-16: Load Transient Trickle Mode.

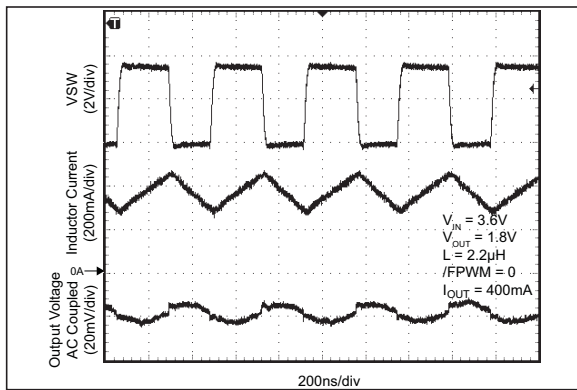

FIGURE 2-14: FPWM Mode.

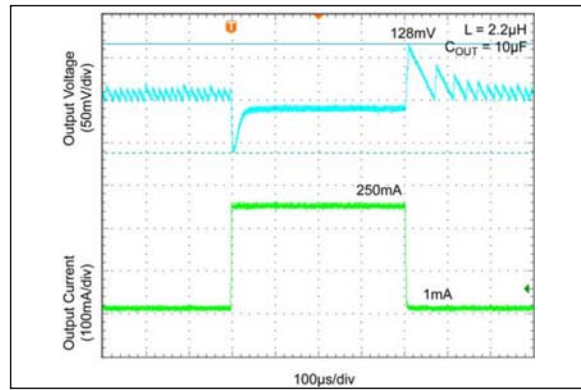

FIGURE 2-17: Load Transient Trickle Mode.

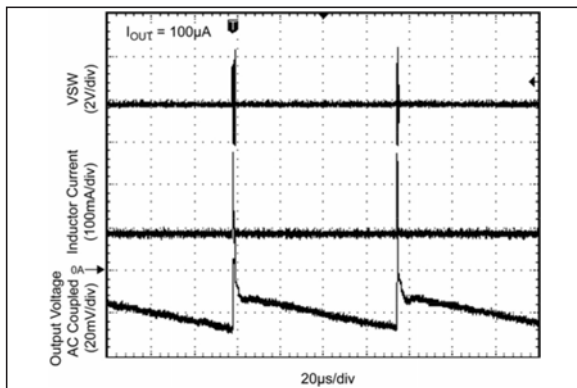

FIGURE 2-15: Trickle Mode.

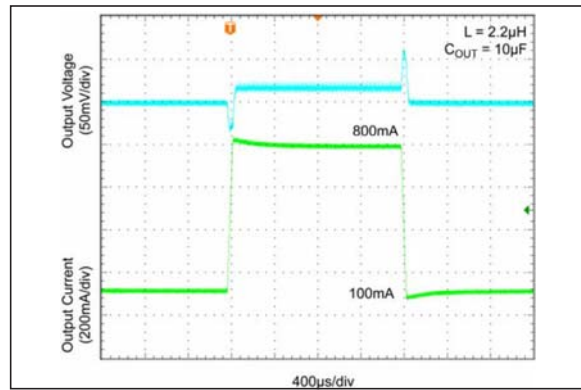

FIGURE 2-18: Load Transient PWM Mode.

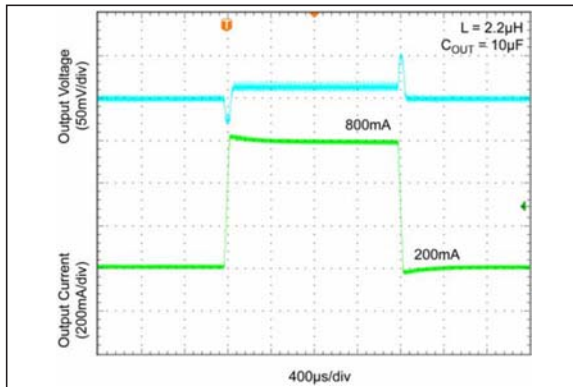

FIGURE 2-19: Load Transient PWM Mode.

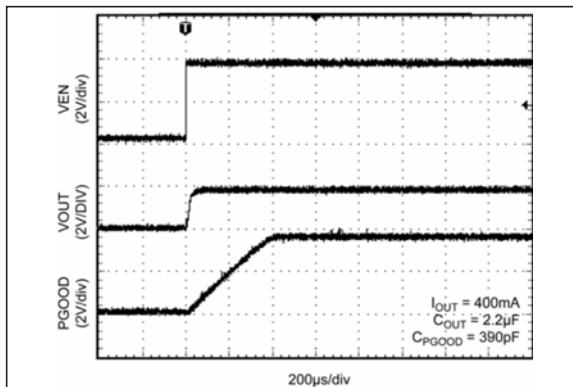

FIGURE 2-20: Enable Response.

MIC2230

3.0 PIN DESCRIPTIONS

The descriptions of the pins are listed in [Table 3-1](#).

TABLE 3-1: PIN FUNCTION TABLE

MIC2230 Adjustable 3X3 QFN	MIC2230 Fixed 3X3 QFN	Symbol	Description
1	—	FB2	Feedback 2: For adjustable voltage options connect the external resistor divider network to FB2 to set the output voltage of regulator 2. Nominal value is 0.8V.
2	2	EN2	Enable 2 input. Logic low powers down regulator 2. Logic high powers up regulator 2. MIC2230 features built-in soft-start circuitry that reduces in-rush current and prevents the output voltage from overshooting at start up.
3	3	AVIN	Analog Supply Voltage: Supply voltage for the analog control circuitry. Requires bypass capacitor to GND.
4	4	SW2	Switch node for regulator 2, connected to external inductor.
5	5	AGND	Analog (signal) ground.
6	6	PGND	Power ground.
7	7	/FPWM	Forced PWM Mode Bar. Grounding this pin forces the device to stay in constant frequency PWM mode only. Pulling this pin high enables automatic Trickle Mode operation.
8	8	SW1	Switch node for regulator 1, connected to external inductor.
9	9	VIN	Supply Voltage: Supply voltage for the internal switches and drivers. Requires bypass capacitor to GND.
10	10	PGOOD	Power Good Output. This output is pulled down unless the regulator 1 output voltage is within +6.25% and -8.5% of regulation. After the output voltage is in regulation, the output starts to go high with an internal 5 μ A current source. A delay time could be programmed by tying a capacitor to this pin.
11	11	EN1	Enable 1 input. Logic low powers down regulator 1. Logic high powers up regulator 1. MIC2230 features built-in soft-start circuitry that reduces in-rush current and prevents the output voltage from overshooting at start up.
12	—	FB1	Feedback 1: For adjustable voltage options connect to the external resistor divider network to FB1 to set the output voltage of regulator 1. Nominal value is 0.8V.
—	1	OUT2	Output Voltage 2. For fixed output voltage options connect OUT2 to the output voltage of regulator 2.
—	12	OUT1	Output Voltage 1. For fixed output voltage options connect OUT1 to the output voltage of regulator 1.
EP	EP	EP	Exposed Thermal pad. Should be connected to the Ground plane.

4.0 FUNCTIONAL DESCRIPTION

4.1 V_{IN}

V_{IN} provides power to the MOSFETs for the switch mode regulator section, along with the current limiting sensing. Due to the high switching speeds, a 10 μ F capacitor is recommended close to V_{IN} and the power ground (PGND) pin for bypassing.

4.2 AV_{IN}

Analog V_{IN} (AV_{IN}) provides power to the analog supply circuitry. AV_{IN} and V_{IN} must be tied together. Careful layout should be considered to ensure high frequency switching noise caused by V_{IN} is reduced before reaching AV_{IN} . A 1 μ F capacitor as close to AV_{IN} as possible is recommended.

4.3 EN1

Enable 1 controls the on and off state of regulator 1. A high logic on Enable 1 (EN1) activates regulator 1 while a low logic deactivates regulator 1. MIC2230 features built-in soft-start circuitry that reduces in-rush current and prevents the output voltage from overshooting at start-up.

4.4 EN2

Enable 2 controls the on and off state of regulator 2. A high logic on Enable 2 (EN2) activates regulator 2 while a low logic deactivates regulator 2. MIC2230 features built-in soft-start circuitry that reduces in-rush current and prevents the output voltage from overshooting at start-up.

4.5 /FPWM

The Forced PWM Mode selects the mode of operation for this device. Grounding this pin forces the device to stay in constant frequency PWM mode only. Pulling this pin high enables automatic selection of Trickle or PWM mode operation, depending on the load. While /FPWM is high and the load is below 100 mA, the device will go into Trickle Mode. If the load is above 100 mA, PWM mode will automatically be selected. Do not leave this pin floating.

4.6 PGOOD

The Power Good Output is pulled down unless the regulator 1 output voltage is within +6.25% or -8.5% of regulation. When the output voltage is in regulation, the PGOOD capacitor will be charged to AV_{IN} by an internal 5 μ A current source through a 1 k Ω resistor. The charge time is approximately 1 μ s per 1 pF of capacitance. For example, a 390 pF capacitor at the PGOOD pin will cause the PGOOD pin voltage to rise from low to high in around 390 μ s. A PGOOD capacitor

is recommended to prevent large output voltage transients from triggering the PGOOD flag unexpectedly.

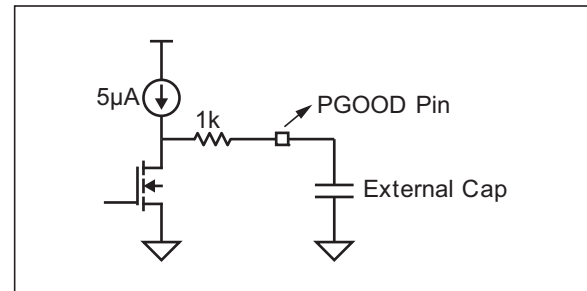

FIGURE 4-1: Power Good Circuit.

4.7 FB1/FB2

The feedback pin (FB) provides the control path to control the output. For adjustable versions, a resistor divider connecting the feedback to the output is used to adjust the desired output voltage. The output voltage is calculated as follows:

EQUATION 4-1:

$$V_{OUT} = V_{REF} \times \left(\frac{R1}{R2} + 1 \right)$$

Where:

$$V_{REF} = 0.8V$$

The external feedback resistors add some quiescent current consumption for adjustable versions. To reduce battery current draw, high resistance values are recommended in the feedback divider. A feedforward capacitor should be connected between the output and feedback (across R1) because of the high resistance value. The large resistor value and the parasitic capacitance of the FB pin can cause a high frequency pole that can reduce the overall system phase margin. By placing a feedforward capacitor, these effects can be significantly reduced. Refer to the [Feedback](#) section for recommended feedforward capacitor values.

4.8 SW1/SW2

The switch (SW) pin connects directly to the inductor and provides the switching current necessary to operate in PWM mode. Due to the high speed switching on this pin, the switch node should be routed away from sensitive nodes.

4.9 PGND

Power ground (PGND) is the ground path for the high current PWM mode. The current loop for the power ground should be as small as possible and separate from the Analog ground (AGND) loop.

4.10 AGND

Signal ground (AGND) is the ground path for the biasing and control circuitry. The current loop for the signal ground should be separate from the Power ground (PGND) loop.

5.0 APPLICATION INFORMATION

5.1 Input Capacitor

A minimum 2.2 μF ceramic is recommended on the V_{IN} pin for bypassing. X5R or X7R dielectrics are recommended for the input capacitor. Y5V dielectrics, aside from losing most of their capacitance over temperature, they also become resistive at high frequencies. This reduces their ability to filter out high frequency noise.

5.2 Output Capacitor

The MIC2230 was designed specifically for use with a 10 μF or greater ceramic output capacitor. The output capacitor requires either an X7R or X5R dielectric. Y5V and Z5U dielectric capacitors, aside from the undesirable effect of their wide variation in capacitance over temperature, become resistive at high frequencies.

5.3 Inductor Selection

Inductor selection will be determined by the following (not necessarily in the order of importance):

- Inductance
- Rated current value
- Size requirements
- DC resistance (DCR)

The MIC2230 was designed for use with a 2.2 μH inductor.

Maximum current ratings of the inductor are generally given in two methods: permissible DC current and saturation current. Permissible DC current can be rated either for a 40°C temperature rise or a 10 to 20% loss in inductance. Ensure the inductor selected can handle the maximum operating current. When saturation current is specified, make sure that there is enough margin that the peak current will not saturate the inductor.

The size requirements refer to the area and height requirements that are necessary to fit a particular design. Please refer to the inductor dimensions on their datasheet.

DC resistance is also important. While DCR is inversely proportional to size, DCR can represent a significant efficiency loss. Refer to the [Efficiency Considerations](#).

5.4 Compensation

The MIC2230 is an internally compensated, current mode buck regulator. Current mode is achieved by sampling the peak current and using the output of the error amplifier to pulse width modulate the switch node and maintain output voltage regulation.

The MIC2230 is designed to be stable with a 2.2 μH inductor with a 10 μF ceramic (X5R) output capacitor.

5.5 Feedback

The MIC2230 provides a feedback pin to adjust the output voltage to the desired level. This pin connects internally to an error amplifier. The error amplifier then compares the voltage at the feedback to the internal 0.8V reference voltage and adjusts the output voltage to maintain regulation. Calculating the resistor divider network for the desired output is shown in [Equation 5-1](#).

EQUATION 5-1:

$$R2 = \frac{R1}{\left(\frac{V_{OUT}}{V_{REF}} - 1\right)}$$

Where:

V_{REF}	=	0.8V
V_{OUT}	=	Desired Output Voltage

For adjustable versions, the FB bias current (10 nA typical) should be a negligible fraction of the current flowing in the feedback resistor divider. This improves the accuracy of the output voltage setting. A small current, in the range of a few microamperes, is typically sufficient and does not significantly increase the operating quiescent current in battery-operated applications. This choice leads to high resistance values.

If operating quiescent current is less of a concern, lower resistance values can be used. Larger resistor values require an additional capacitor (feed-forward) from the output to the feedback. The large high-side resistor value and the parasitic capacitance on the feedback pin (~10 pF) can cause an additional pole in the control loop. The additional pole can create a phase loss at high frequencies. This phase loss degrades transient response by reducing phase margin. Adding feed-forward capacitance negates the parasitic capacitive effects of the feedback pin. See [Table 5-1](#) for recommended feedforward capacitor values.

TABLE 5-1: RECOMMENDED FEED-FORWARD CAPACITOR

Recommended C_{FF}	Total Feedback Resistance
22 pF	1 M Ω - 2 M Ω
47 pF	500 k Ω - 1 M Ω
100 pF	100 k Ω - 500 k Ω
180 pF	10 k Ω - 100 k Ω

MIC2230

Large feedback resistor values increase impedance, making the feedback node more susceptible to noise pick-up. A feed forward capacitor would also reduce noise pick-up by providing a low impedance path to the output. Refer to [Table 5-1](#) for recommended feedforward capacitor values

5.6 Efficiency Considerations

Efficiency is defined as the amount of useful output power, divided by the amount of power supplied.

EQUATION 5-2:

$$\text{Efficiency}_{\%} = \left(\frac{V_{OUT} \times I_{OUT}}{V_{IN} \times I_{IN}} \right) \times 100$$

Maintaining high efficiency serves two purposes. It reduces power dissipation in the power supply, reducing the need for heat sinks and thermal design considerations and it reduces consumption of current for battery powered applications. Reduced current draw from a battery increases the devices operating time and is critical in hand held devices.

There are two types of losses in switching converters: DC losses and switching losses. DC losses are simply the power dissipation of I^2R . Power is dissipated in the high-side switch during the on cycle. Power loss is equal to the high side MOSFET $R_{DS(ON)}$ multiplied by the Switch Current². During the off cycle, the low side N-channel MOSFET conducts, also dissipating power. Device operating current also reduces efficiency. The product of the quiescent (operating) current and the supply voltage is another DC loss. The current required driving the gates on and off at a constant 2.5 MHz frequency and the switching transitions make up the switching losses.

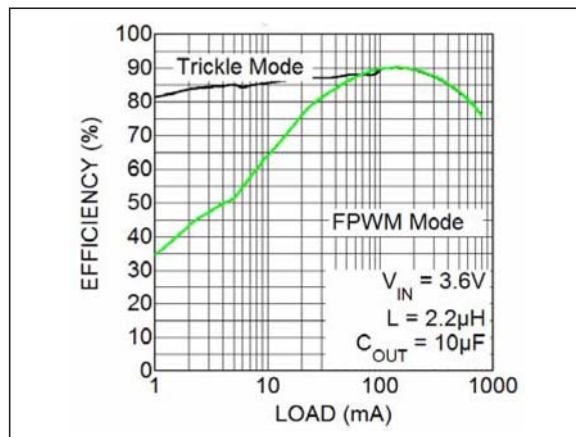

FIGURE 5-1: MIC2230 Efficiency
 $V_{OUT} = 1.575$.

The figure above shows an efficiency curve. From no load to 100 mA, efficiency losses are dominated by quiescent current losses, gate drive and transition losses. By forcing the MIC2230 into Trickle Mode (/FPWM = High), the buck regulator significantly reduces the required switching current by entering into a PFM (Pulse Frequency Modulation) mode. This significantly increases efficiency at low output currents.

Over 100 mA, efficiency loss is dominated by MOSFET $R_{DS(ON)}$ and inductor losses. Higher input supply voltages will increase the Gate-to-Source threshold on the internal MOSFETs, reducing the internal $R_{DS(ON)}$. This improves efficiency by reducing DC losses in the device. All but the inductor losses are inherent to the device. In which case, inductor selection becomes increasingly critical in efficiency calculations. As the inductors are reduced in size, the DC resistance (DCR) can become quite significant. The DCR losses can be calculated as shown in Equation 5-3.

EQUATION 5-3:

$$L_{Pd} = I_{OUT}^2 \times DCR$$

From that, the loss in efficiency due to inductor resistance can be calculated as shown in Equation 5-4.

EQUATION 5-4:

$$\text{Efficiency}_{Loss} = \left[1 - \left(\frac{V_{OUT} \times I_{OUT}}{V_{OUT} \times I_{OUT} + L_{Pd}} \right) \right] \times 100$$

Efficiency loss due to DCR is minimal at light loads and gains significance as the load is increased. Inductor selection becomes a trade-off between efficiency and size in this case.

5.7 Trickle Mode Operation

Trickle Mode operation is achieved by clamping the minimum peak current to approximately 150 mA. This forces a PFM mode by comparing the output voltage to the internal reference. If the feedback voltage is less than 0.8V, the MIC2230 turns on the high side until the peak inductor current reaches approximately 150 mA. A separate comparator then monitors the output voltage. If the feedback voltage is greater than 0.8V, the high side switch is then used as a 10 μ A current source, never turning off completely. This creates a highly efficient light load mode by increasing the time it takes for the output capacitor to discharge, delaying the amount of switching required and increasing light load efficiency. While operating in this mode without any load, the output voltage may rise over the nominal operating voltage range. For applications that require tight voltage tolerances, a minimum load of 150 μ A is recommended.

This load may either be used by the attached system, by lowering the feedback resistors or by adding an additional load resistor in parallel with the output capacitor.

MIC2230

When the load current is greater than approximately 100 mA, the MIC2230 automatically switches to PWM mode.

5.8 FPWM Operation

In forced PWM Mode (/FPWM = LOW) the MIC2230 is forced to provides constant switching at 2.5 MHz with synchronous internal MOSFETs throughout the load current. In FPWM Mode, the output ripple can be as low as 7 mV.

6.0 MIC2230 EVALUATION BOARD SCHEMATIC

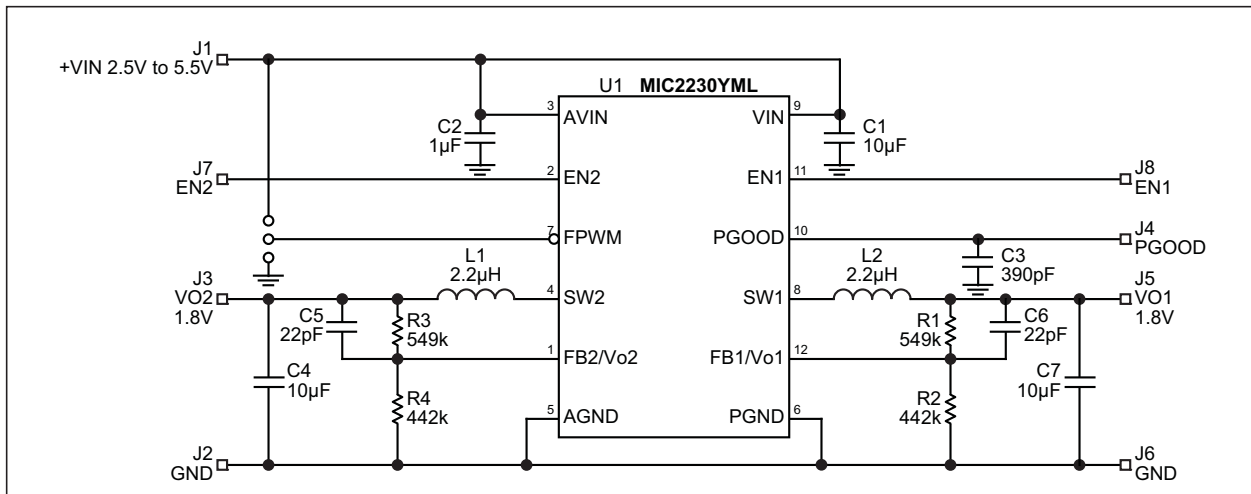

FIGURE 6-1: MIC2230 Adjustable Option (1.8V, 1.8V).

TABLE 6-1: BILL OF MATERIALS

Item	Part Number	Manufacturer	Description	Qty
C1	C1608X5R0J106K	TDK	10 µF Ceramic Capacitor, 6.3V, X5R, Size 0603	1
C2	C1005X5R0J105K	TDK	1 µF Ceramic Capacitor, 6.3V, X5R, Size 0402	1
C3	C0603Y391KXXA	Vishay	390 pF Ceramic Capacitor, 25V, X7R, Size 0603	1
C4, C5	0603ZD106MAT	AVX	10 µF Ceramic Capacitor, 6.3V, X5R, Size 0603	2
L1, L2	CDRH2D11/HPNP-2 R2NC	Sumida	2.2 µH, 1.1A I _{SAT} , 120 mΩ, (1.2 mm × 3.2 mm × 3.2 mm)	2
	LQH43CN2R2M03	Murata	2.2 µH, 900 mA I _{SAT} , 110 mΩ, (2.6 mm × 3.2 mm × 4.5 mm)	
	EPL2014-222MLB	Coilcraft	2.2 µH, 1.3A I _{SAT} , 120 mΩ, (1.4 mm × 1.8 mm × 2.0 mm)	
R2, R4	CRCW06034423FT1	Vishay	442 kΩ, 1%, Size 0603	2
R1, R3	CRCW06035493FT1	Vishay	549 kΩ, 1%, Size 0603	2
U1	MIC2230-AAYML	Microchip	2.5 MHz Dual Phase PWM Buck Regulator	1
L1, L2	CDRH2D11/HPNP-2 R2NC	Sumida	2.2 µH, 1.1A I _{SAT} , 120 mΩ, (1.2 mm × 3.2 mm × 3.2 mm)	2

7.0 PACKAGING INFORMATION

7.1 Package Marking Information

12-lead QFN*

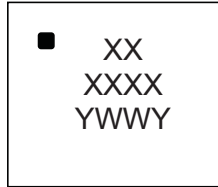

Example

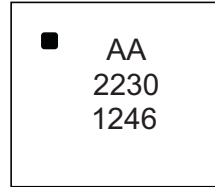

Legend:	XX...X	Product code or customer-specific information
	Y	Year code (last digit of calendar year)
	YY	Year code (last 2 digits of calendar year)
	WW	Week code (week of January 1 is week '01')
	NNN	Alphanumeric traceability code
	(e3)	Pb-free JEDEC® designator for Matte Tin (Sn)
	*	This package is Pb-free. The Pb-free JEDEC designator (e3) can be found on the outer packaging for this package.
	●, ▲, ▼	Pin one index is identified by a dot, delta up, or delta down (triangle mark).
Note:	In the event the full Microchip part number cannot be marked on one line, it will be carried over to the next line, thus limiting the number of available characters for customer-specific information. Package may or may not include the corporate logo.	
	Underbar (̄) and/or Overbar (¯) symbol may not be to scale.	

TITLE

12 LEAD DFN 3x3mm PACKAGE OUTLINE & RECOMMENDED LAND PATTERN

DRAWING #	DFN33-12LD-PL-1	UNIT	MM
-----------	-----------------	------	----

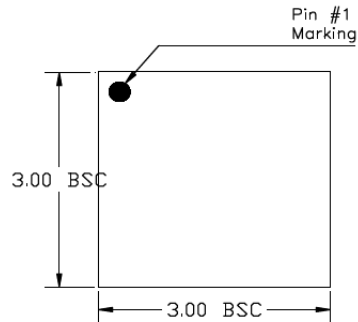

TOP VIEW

NOTE: 1, 2, 3

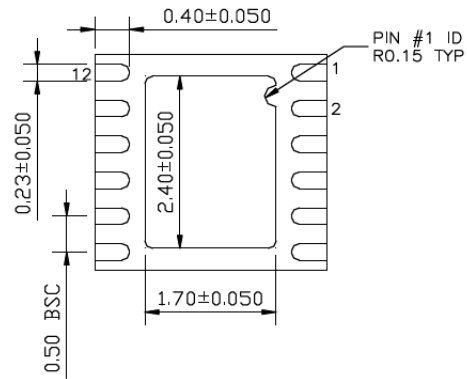

BOTTOM VIEW

NOTE: 1, 2, 3

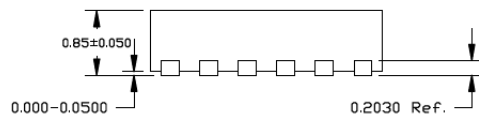

SIDE VIEW

NOTE: 1, 2, 3

NOTE:

1. MAX PACKAGE WARPAGE IS 0.05 MM
2. MAX ALLOWABLE BURR IS 0.076 MM IN ALL DIRECTIONS
3. PIN #1 IS ON TOP WILL BE LASER MARKED
4. RED CIRCLE IN LAND PATTERN INDICATE THERMAL VIA. SIZE SHOULD BE 0.30-0.35 MM IN DIAMETER AND SHOULD BE CONNECTED TO GND FOR MAX THERMAL PERFORMANCE
5. GREEN RECTANGLES (SHADED AREA) indicate SOLDER STENCIL OPENING ON EXPOSED PAD AREA. SIZE SHOULD BE 0.50x0.95 MM IN SIZE, 0.20 MM SPACING.

Note: For the most current package drawings, please see the Microchip Packaging Specification located at <http://www.microchip.com/packaging>.

POD-Land Pattern drawing # DFN33-12LD-PL-1

RECOMMENDED LAND PATTERN

NOTE: 4, 5

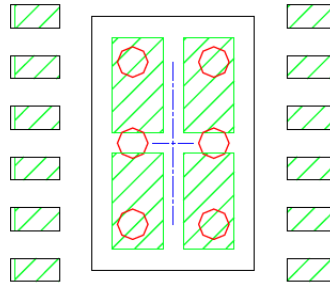

STACKED-UP

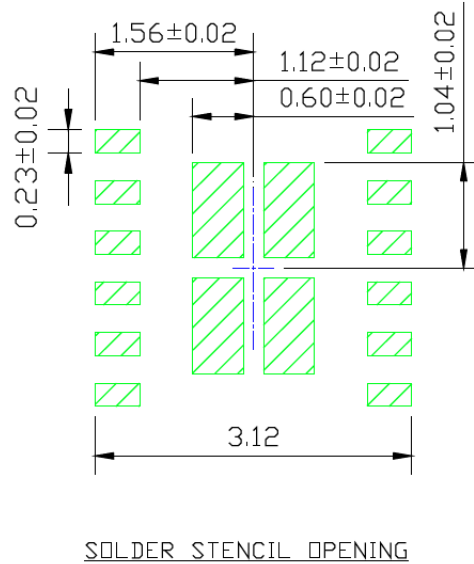
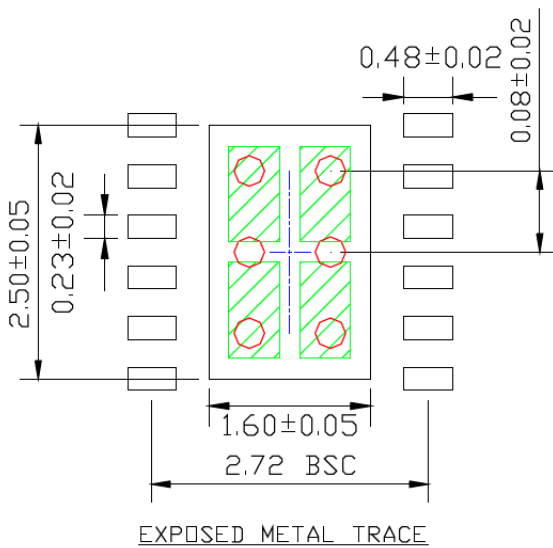

Note: For the most current package drawings, please see the Microchip Packaging Specification located at <http://www.microchip.com/packaging>.

APPENDIX A: REVISION HISTORY

Revision A (April 2017)

- Converted Micrel document MIC2230 to Microchip data sheet template DS20005748A.
- Minor grammatical text changes throughout.

MIC2230

NOTES:

PRODUCT IDENTIFICATION SYSTEM

To order or obtain information, e.g., on pricing or delivery, contact your local Microchip representative or sales office.

<u>PART NO.</u>	<u>-XX</u>	<u>X</u>	<u>XX</u>	
Device	Output Voltage	Temperature Range	Package	
Device:	MIC2230:	Dual Synchronous 800 mA/800 mA Step-Down DC/DC Regulator		
Output Voltages: (V _{OUT1} , V _{OUT2})	AA =	Adjustable		
	G4 =	1.8V / 1.2V		
	GFH =	1.8V / 1.575V		
	GS =	1.8V / 3.3V		
	J4 =	2.5V / 1.2V		
	S4 =	3.3V / 1.2V		
	SS =	3.3V / 3.3V		
Temperature Range:	Y =	-40°C to +125°C		
Packages:	ML =	12-Lead, 3 mm × 3 mm TDFN		
Media Type:	TR =	Tape and Reel; 5000/reel.		
				Examples:
				a) MIC2230-AAYML TR: Dual Synchronous 800 mA/800 mA, Step-Down DC/DC Regulator, Adjustable Output Voltage, -40°C to +125°C, 12LD TDFN, Tape and Reel
				b) MIC2230-G4YML TR: Dual Synchronous 800 mA/800 mA, Step-Down DC/DC Regulator, 1.8V/1.2V Output Voltage, -40°C to +125°C, 12LD TDFN, Tape and Reel
				c) MIC2230-GFHYML TR: Dual Synchronous 800 mA/800 mA, Step-Down DC/DC Regulator, 1.8V/1.575V Output Voltage, -40°C to +125°C, 12LD TDFN
				d) MIC2230-GSYML: Dual Synchronous 800 mA/800 mA, Step-Down DC/DC Regulator, 1.8V/3.3V Output Voltage, -40°C to +125°C, 12LD TDFN
				e) MIC2230-J4YML: Dual Synchronous 800 mA/800 mA, Step-Down DC/DC Regulator, 2.5V/1.2V Output Voltage, -40°C to +125°C, 12LD TDFN
				f) MIC2230-S4YML: Dual Synchronous 800 mA/800 mA, Step-Down DC/DC Regulator, 3.3V/1.2V Output Voltage, -40°C to +125°C, 12LD TDFN
				g) MIC2230-SSYML: Dual Synchronous 800 mA/800 mA, Step-Down DC/DC Regulator, 3.3V/3.3V Output Voltage, -40°C to +125°C, 12LD TDFN
				Note 1: Tape and Reel identifier only appears in the catalog part number description. This identifier is used for ordering purposes and is not printed on the device package. Check with your Microchip Sales Office for package availability with the Tape and Reel option.

MIC2230

NOTES:

Note the following details of the code protection feature on Microchip devices:

- Microchip products meet the specification contained in their particular Microchip Data Sheet.
- Microchip believes that its family of products is one of the most secure families of its kind on the market today, when used in the intended manner and under normal conditions.
- There are dishonest and possibly illegal methods used to breach the code protection feature. All of these methods, to our knowledge, require using the Microchip products in a manner outside the operating specifications contained in Microchip's Data Sheets. Most likely, the person doing so is engaged in theft of intellectual property.
- Microchip is willing to work with the customer who is concerned about the integrity of their code.
- Neither Microchip nor any other semiconductor manufacturer can guarantee the security of their code. Code protection does not mean that we are guaranteeing the product as “unbreakable.”

Code protection is constantly evolving. We at Microchip are committed to continuously improving the code protection features of our products. Attempts to break Microchip's code protection feature may be a violation of the Digital Millennium Copyright Act. If such acts allow unauthorized access to your software or other copyrighted work, you may have a right to sue for relief under that Act.

Information contained in this publication regarding device applications and the like is provided only for your convenience and may be superseded by updates. It is your responsibility to ensure that your application meets with your specifications. MICROCHIP MAKES NO REPRESENTATIONS OR WARRANTIES OF ANY KIND WHETHER EXPRESS OR IMPLIED, WRITTEN OR ORAL, STATUTORY OR OTHERWISE, RELATED TO THE INFORMATION, INCLUDING BUT NOT LIMITED TO ITS CONDITION, QUALITY, PERFORMANCE, MERCHANTABILITY OR FITNESS FOR PURPOSE. Microchip disclaims all liability arising from this information and its use. Use of Microchip devices in life support and/or safety applications is entirely at the buyer's risk, and the buyer agrees to defend, indemnify and hold harmless Microchip from any and all damages, claims, suits, or expenses resulting from such use. No licenses are conveyed, implicitly or otherwise, under any Microchip intellectual property rights unless otherwise stated.

Microchip received ISO/TS-16949:2009 certification for its worldwide headquarters, design and wafer fabrication facilities in Chandler and Tempe, Arizona; Gresham, Oregon and design centers in California and India. The Company's quality system processes and procedures are for its PIC® MCUs and dsPIC® DSCs, KEELoq® code hopping devices, Serial EEPROMs, microperipherals, nonvolatile memory and analog products. In addition, Microchip's quality system for the design and manufacture of development systems is ISO 9001:2000 certified.

**QUALITY MANAGEMENT SYSTEM
CERTIFIED BY DNV
= ISO/TS 16949 =**

Trademarks

The Microchip name and logo, the Microchip logo, AnyRate, dsPIC, FlashFlex, flexPWR, Heldo, JukeBlox, KeeLoq, KeeLoq logo, Klear, LANCheck, LINK MD, MediaLB, MOST, MOST logo, MPLAB, OptoLyzer, PIC, PICSTART, PIC32 logo, RightTouch, SpyNIC, SST, SST Logo, SuperFlash and UNI/O are registered trademarks of Microchip Technology Incorporated in the U.S.A. and other countries.

ClockWorks, The Embedded Control Solutions Company, ETHERSYNCH, Hyper Speed Control, HyperLight Load, IntellIMOS, mTouch, Precision Edge, and QUIET-WIRE are registered trademarks of Microchip Technology Incorporated in the U.S.A.

Analog-for-the-Digital Age, Any Capacitor, AnyIn, AnyOut, BodyCom, chipKIT, chipKIT logo, CodeGuard, dsPICDEM, dsPICDEM.net, Dynamic Average Matching, DAM, ECAN, EtherGREEN, In-Circuit Serial Programming, ICSP, Inter-Chip Connectivity, JitterBlocker, KlearNet, KlearNet logo, MiWi, motorBench, MPASM, MPF, MPLAB Certified logo, MPLIB, MPLINK, MultiTRAK, NetDetach, Omniscient Code Generation, PICDEM, PICDEM.net, PICkit, PICtail, PureSilicon, RightTouch logo, REAL ICE, Ripple Blocker, Serial Quad I/O, SQL, SuperSwitcher, SuperSwitcher II, Total Endurance, TSHARC, USBCheck, VariSense, ViewSpan, WiperLock, Wireless DNA, and ZENA are trademarks of Microchip Technology Incorporated in the U.S.A. and other countries.

SQTP is a service mark of Microchip Technology Incorporated in the U.S.A.

Silicon Storage Technology is a registered trademark of Microchip Technology Inc. in other countries.

GestIC is a registered trademarks of Microchip Technology Germany II GmbH & Co. KG, a subsidiary of Microchip Technology Inc., in other countries.

All other trademarks mentioned herein are property of their respective companies.

© 2017, Microchip Technology Incorporated, Printed in the U.S.A., All Rights Reserved.

ISBN: 978-1-5224-1653-1



MICROCHIP

Worldwide Sales and Service

AMERICAS

Corporate Office
2355 West Chandler Blvd.
Chandler, AZ 85224-6199
Tel: 480-792-7200
Fax: 480-792-7277
Technical Support:
<http://www.microchip.com/support>
Web Address:
www.microchip.com

Atlanta
Duluth, GA
Tel: 678-957-9614
Fax: 678-957-1455

Austin, TX
Tel: 512-257-3370

Boston
Westborough, MA
Tel: 774-760-0087
Fax: 774-760-0088

Chicago
Itasca, IL
Tel: 630-285-0071
Fax: 630-285-0075

Dallas
Addison, TX
Tel: 972-818-7423
Fax: 972-818-2924

Detroit
Novi, MI
Tel: 248-848-4000

Houston, TX
Tel: 281-894-5983

Indianapolis
Noblesville, IN
Tel: 317-773-8323
Fax: 317-773-5453
Tel: 317-536-2380

Los Angeles
Mission Viejo, CA
Tel: 949-462-9523
Fax: 949-462-9608
Tel: 951-273-7800

Raleigh, NC
Tel: 919-844-7510

New York, NY
Tel: 631-435-6000

San Jose, CA
Tel: 408-735-9110
Tel: 408-436-4270

Canada - Toronto
Tel: 905-695-1980
Fax: 905-695-2078

ASIA/PACIFIC

Asia Pacific Office
Suites 3707-14, 37th Floor
Tower 6, The Gateway
Harbour City, Kowloon

Hong Kong
Tel: 852-2943-5100
Fax: 852-2401-3431

Australia - Sydney
Tel: 61-2-9868-6733
Fax: 61-2-9868-6755

China - Beijing
Tel: 86-10-8569-7000
Fax: 86-10-8528-2104

China - Chengdu
Tel: 86-28-8665-5511
Fax: 86-28-8665-7889

China - Chongqing
Tel: 86-23-8980-9588
Fax: 86-23-8980-9500

China - Dongguan
Tel: 86-769-8702-9880

China - Guangzhou
Tel: 86-20-8755-8029

China - Hangzhou
Tel: 86-571-8792-8115
Fax: 86-571-8792-8116

China - Hong Kong SAR
Tel: 852-2943-5100
Fax: 852-2401-3431

China - Nanjing
Tel: 86-25-8473-2460
Fax: 86-25-8473-2470

China - Qingdao
Tel: 86-532-8502-7355
Fax: 86-532-8502-7205

China - Shanghai
Tel: 86-21-3326-8000
Fax: 86-21-3326-8021

China - Shenyang
Tel: 86-24-2334-2829
Fax: 86-24-2334-2393

China - Shenzhen
Tel: 86-755-8864-2200
Fax: 86-755-8203-1760

China - Wuhan
Tel: 86-27-5980-5300
Fax: 86-27-5980-5118

China - Xian
Tel: 86-29-8833-7252
Fax: 86-29-8833-7256

ASIA/PACIFIC

China - Xiamen
Tel: 86-592-2388138
Fax: 86-592-2388130

China - Zhuhai
Tel: 86-756-3210040
Fax: 86-756-3210049

India - Bangalore
Tel: 91-80-3090-4444
Fax: 91-80-3090-4123

India - New Delhi
Tel: 91-11-4160-8631
Fax: 91-11-4160-8632

India - Pune
Tel: 91-20-3019-1500

Japan - Osaka
Tel: 81-6-6152-7160
Fax: 81-6-6152-9310

Japan - Tokyo
Tel: 81-3-6880-3770
Fax: 81-3-6880-3771

Korea - Daegu
Tel: 82-53-744-4301
Fax: 82-53-744-4302

Korea - Seoul
Tel: 82-2-554-7200
Fax: 82-2-558-5932 or
82-2-558-5934

Malaysia - Kuala Lumpur
Tel: 60-3-6201-9857
Fax: 60-3-6201-9859

Malaysia - Penang
Tel: 60-4-227-8870
Fax: 60-4-227-4068

Philippines - Manila
Tel: 63-2-634-9065
Fax: 63-2-634-9069

Singapore
Tel: 65-6334-8870
Fax: 65-6334-8850

Taiwan - Hsin Chu
Tel: 886-3-5778-366
Fax: 886-3-5770-955

Taiwan - Kaohsiung
Tel: 886-7-213-7830

Taiwan - Taipei
Tel: 886-2-2508-8600
Fax: 886-2-2508-0102

Thailand - Bangkok
Tel: 66-2-694-1351
Fax: 66-2-694-1350

EUROPE

Austria - Wels
Tel: 43-7242-2244-39
Fax: 43-7242-2244-393

Denmark - Copenhagen
Tel: 45-4450-2828
Fax: 45-4485-2829

Finland - Espoo
Tel: 358-9-4520-820

France - Paris
Tel: 33-1-69-53-63-20
Fax: 33-1-69-30-90-79

France - Saint Cloud
Tel: 33-1-30-60-70-00

Germany - Garching
Tel: 49-8931-9700

Germany - Haan
Tel: 49-2129-3766400

Germany - Heilbronn
Tel: 49-7131-67-3636

Germany - Karlsruhe
Tel: 49-721-625370

Germany - Munich
Tel: 49-89-627-144-0
Fax: 49-89-627-144-44

Germany - Rosenheim
Tel: 49-8031-354-560

Israel - Ra'anana
Tel: 972-9-744-7705

Italy - Milan
Tel: 39-0331-742611
Fax: 39-0331-466781

Italy - Padova
Tel: 39-049-7625286

Netherlands - Drunen
Tel: 31-416-690399
Fax: 31-416-690340

Norway - Trondheim
Tel: 47-7289-7561

Poland - Warsaw
Tel: 48-22-3325737

Romania - Bucharest
Tel: 40-21-407-87-50

Spain - Madrid
Tel: 34-91-708-08-90
Fax: 34-91-708-08-91

Sweden - Gothenberg
Tel: 46-31-704-60-40

Sweden - Stockholm
Tel: 46-8-5090-4654

UK - Wokingham
Tel: 44-118-921-5800
Fax: 44-118-921-5820

Looking for pricing, stock, or lifecycle information?

Click below to explore more details on WIN SOURCE:

- ⊖ [View MIC2230-GFHYML-TR on WIN SOURCE](#)
- ⊖ [Microchip Technology](#) Information

Optimize Your Supply Chain with WIN SOURCE Solutions

- ✓ Global Sourcing Solution
- ✓ Obsolete Management
- ✓ Cost Control Management
- ✓ Shortage Management
- ✓ Alternative Solution
- ✓ Excess Inventory Management