



**THE DATASHEET OF
MIC29371-5.0BU**





MIC2937A/29371/29372

750mA Low-Dropout Voltage Regulator

General Description

The MIC2937A family are “bulletproof” efficient voltage regulators with very low dropout voltage (typically 40mV at light loads and 300mV at 500mA), and very low quiescent current (160µA typical). The quiescent current of the MIC2937A increases only slightly in dropout, thus prolonging battery life. Key MIC2937A features include protection against reversed battery, fold-back current limiting, and automotive “load dump” protection (60V positive transient).

The MIC2937 is available in several configurations. The MIC2937A-xx devices are three pin fixed voltage regulators with 3.3V, 5V, and 12V outputs available. The MIC29371 is a fixed regulator offering logic compatible ON/OFF switching input and an error flag output. This flag may also be used as a power-on reset signal. A logic-compatible shutdown input is provided on the adjustable MIC29372, which enables the regulator to be switched on and off.

Features

- High output voltage accuracy
- Guaranteed 750mA output
- Low quiescent current
- Low dropout voltage
- Extremely tight load and line regulation
- Very low temperature coefficient
- Current and thermal limiting
- Input can withstand –20V reverse battery and +60V positive transients
- Error flag warns of output dropout
- Logic-controlled electronic shutdown
- Output programmable from 1.24V to 26V(MIC29372)
- Available in TO-220, TO-263, TO-220-5, and TO-263-5 packages.

Applications

- Battery Powered Equipment
- Cellular Telephones
- Laptop, Notebook, and Palmtop Computers
- PCMCIA V_{CC} and V_{PP} Regulation/Switching
- Bar Code Scanners
- Automotive Electronics
- SMPS Post-Regulator/ DC to DC Modules
- High Efficiency Linear Power Supplies

Pin Configuration

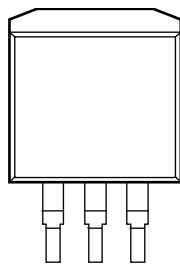

1 2 3
INPUT GROUND OUTPUT

TO-263 Package
(MIC2937A-xxBU/WU)

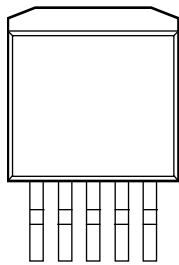

TO-263-5 Package
(MIC29371/29372BU/WU)

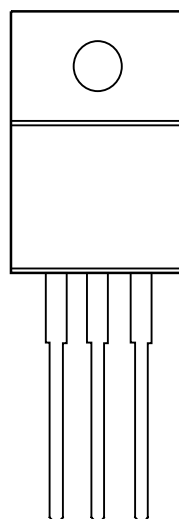

1 2 3
INPUT GROUND OUTPUT

TO-220 Package
(MIC2937A-xxBT/WT)

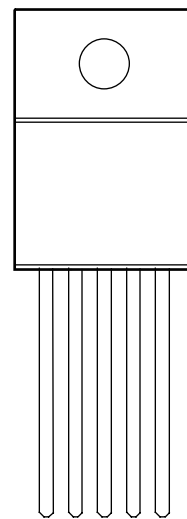

1 2 3 4 5
TO-220-5 Package
(MIC29371/29372BT/WT)

Five Lead Package Pin Functions:

	MIC29371	MIC29372
1)	Error	Adjust
2)	Input	Shutdown
3)	Ground	Ground
4)	Output	Input
5)	Shutdown	Output

The TAB is Ground on the TO-220 and TO-263 packages.

Ordering Information

Part Number		Voltage	Junction Temp. Range	Package
Standard	RoHS Compliant*			
MIC2937A-3.3BU	MIC2937A-3.3WU	3.3V	-40°C to +125°C	TO-263-3
MIC2937A-3.3BT	MIC2937A-3.3WT	3.3V	-40°C to +125°C	TO-220-3
MIC2937A-5.0BU	MIC2937A-5.0WU	5.0V	-40°C to +125°C	TO-263-3
MIC2937A-5.0BT	MIC2937A-5.0WT	5.0V	-40°C to +125°C	TO-220-3
MIC2937A-12BU	MIC2937A-12WU	12V	-40°C to +125°C	TO-263-3
MIC2937A-12BT	MIC2937A-12WT	12V	-40°C to +125°C	TO-220-3
MIC29371-3.3BU	MIC29371-3.3WU	3.3V	-40°C to +125°C	TO-263-5
MIC29371-3.3BT	MIC29371-3.3WT	3.3V	-40°C to +125°C	TO-220-5
MIC29371-5.0BU	MIC29371-5.0WU	5.0V	-40°C to +125°C	TO-263-5
MIC29371-5.0BT	MIC29371-5.0WT	5.0V	-40°C to +125°C	TO-220-5
MIC29371-12BU	MIC29371-12WU	12V	-40°C to +125°C	TO-263-5
MIC29371-12BT	MIC29371-12WT	12V	-40°C to +125°C	TO-220-5
MIC29372BU	MIC29372WU	ADJ	-40°C to +125°C	TO-263-5
MIC29372BT	MIC29372WT	ADJ	-40°C to +125°C	TO-220-5

* RoHS compliant with 'high-melting solder' exemption.

Absolute Maximum Ratings

Power Dissipation (Note 1).....	Internally Limited
Lead Temperature (Soldering, 5 seconds).....	260°C
Storage Temperature Range.....	-65°C to +150°C
Operating Junction Temperature Range	-40°C to +125°C
TO-220 θ_{JC}	2.5°C/W
TO-263 θ_{JC}	2.5°C/W
Input Supply Voltage.....	-20V to +60V

Operating Input Supply Voltage.....	2V [†] to 26V
Adjust Input Voltage (Notes 9 and 10).....	-1.5V to +26V
Shutdown Input Voltage	-0.3V to +30V
Error Comparator Output Voltage.....	-0.3V to +30V

[†] Across the full operating temperature, the minimum input voltage range for full output current is 4.3V to 26V. Output will remain in-regulation at lower output voltages and low current loads down to an input of 2V at 25°C.

Electrical Characteristics

Limits in standard typeface are for $T_J = 25^\circ\text{C}$ and limits in **boldface** apply over the full operating temperature range. Unless otherwise specified, $V_{IN} = V_{OUT} + 1\text{V}$, $I_L = 5\text{mA}$, $C_L = 10\mu\text{F}$. The MIC29372 are programmed for a 5V output voltage, and $V_{SHUTDOWN} \leq 0.6\text{V}$ (MIC29371-xx and MIC29372 only).

Symbol	Parameter	Conditions	Min	Typical	Max	Units	
V_O	Output Voltage Accuracy	Variation from factory trimmed V_{OUT}	-1		1	%	
		$5\text{mA} \leq I_L \leq 500\text{mA}$	-2		2		
		MIC2937A-12 and 29371-12 only:	-1.5		1.5		
		$5\text{mA} \leq I_L \leq 500\text{mA}$	-3		3		
$\frac{\Delta V_O}{\Delta T}$	Output Voltage Temperature Coef.	(Note 2) Output voltage > 10V		20	100	ppm/°C	
				80	350		
$\frac{\Delta V_O}{V_O}$	Line Regulation	$V_{IN} = V_{OUT} + 1\text{V}$ to 26V		0.03	0.10	%	
					0.40		
$\frac{\Delta V_O}{V_O}$	Load Regulation	$I_L = 5$ to 500mA (Note 3)		0.04	0.16	%	
					0.30		
$V_{IN} - V_O$	Dropout Voltage (Note 4)	$I_L = 5\text{mA}$		80	150	mV	
		$I_L = 100\text{mA}$		200	180		
		$I_L = 500\text{mA}$	Output voltage > 10V		240		
		$I_L = 750\text{mA}$	Output voltage > 10V		300		
					420		600
I_{GND}	Ground Pin Current (Note 5)	$I_L = 5\text{mA}$		160	250	μA	
		$I_L = 100\text{mA}$		1	300		
		$I_L = 500\text{mA}$		8	2.5	mA	
		$I_L = 750\text{mA}$		15	3		
I_{GNDDO}	Ground Pin Current at Dropout (Note 5)	$V_{IN} = 0.5\text{V}$ less than designed V_{OUT} ($V_{OUT} \geq 3.3\text{V}$) $I_O = 5\text{mA}$		200	500	μA	
I_{LIMIT}	Current Limit	$V_{OUT} = 0\text{V}$ (Note 6)		1.1	1.5	A	
$\frac{\Delta V_O}{\Delta P_D}$	Thermal Regulation	(Note 7)		0.05	0.2	%/W	
e_n	Output Noise Voltage (10Hz to 100kHz) $I_L = 100\text{mA}$	$C_L = 10\mu\text{F}$		400		$\mu\text{V RMS}$	
		$C_L = 100\mu\text{F}$		260			

Electrical Characteristics (Continued)**MIC29372**

Parameter	Conditions	Min	Typical	Max	Units
Reference Voltage		1.223 1.210	1.235	1.247 1.260	V V max
Reference Voltage	(Note 8)	1.204		1.266	V
Adjust Pin Bias Current			20	40 60	nA
Reference Voltage Temperature Coefficient	(Note 7)		20		ppm/°C
Adjust Pin Bias Current Temperature Coefficient			0.1		nA/°C

Error Comparator MIC29371

Output Leakage Current	$V_{OH} = 26V$		0.01	1.00 2.00	μA
Output Low Voltage	$V_{IN} = 4.5V$ $I_{OL} = 250\mu A$		150	250 400	mV
Upper Threshold Voltage	(Note 9)	40 25	60		mV
Lower Threshold Voltage	(Note 9)		75	95 140	mV
Hysteresis	(Note 9)		15		mV

Shutdown Input MIC29371/MIC29372

Input Logic Voltage Low (ON)	High (OFF)	2.0	1.3	0.7	V
Shutdown Pin Input Current	$V_{SHUTDOWN} = 2.4V$		30	50 100	μA
Regulator Output Current in Shutdown	$V_{SHUTDOWN} = 26V$		450	600 750	μA
	(Note 10)		3	10 20	μA

Note 1: Absolute maximum ratings indicate limits beyond which damage to the component may occur. Electrical specifications do not apply when operating the device outside of its rated operating conditions. The maximum allowable power dissipation is a function of the maximum junction temperature, $T_{J(MAX)}$, the junction-to-ambient thermal resistance, θ_{JA} , and the ambient temperature, T_A . The maximum allowable power dissipation at any ambient temperature is calculated using: $P_{(MAX)} = (T_{J(MAX)} - T_A) / \theta_{JA}$. Exceeding the maximum allowable power dissipation will result in excessive die temperature, and the regulator will go into thermal shutdown.

Note 2: Output voltage temperature coefficient is defined as the worst case voltage change divided by the total temperature range.

Note 3: Regulation is measured at constant junction temperature using low duty cycle pulse testing. Changes in output voltage due to heating effects are covered by the thermal regulation specification.

Note 4: Dropout Voltage is defined as the input to output differential at which the output voltage drops 100 mV below its nominal value measured at 1V differential. At low values of programmed output voltage, the minimum input supply voltage of 4.3V over temperature must be taken into account. The MIC2937A operates down to 2V of input at reduced output current at 25°C.

Note 5: Ground pin current is the regulator quiescent current. The total current drawn from the source is the sum of the load current plus the ground pin current.

Note 6: The MIC2937A family features fold-back current limiting. The short circuit ($V_{OUT} = 0V$) current limit is less than the maximum current with normal output voltage.

Note 7: Thermal regulation is defined as the change in output voltage at a time T after a change in power dissipation is applied, excluding load or line regulation effects. Specifications are for a 200mA load pulse at $V_{IN} = 20V$ (a 4W pulse) for $T = 10ms$.

Note 8: $V_{REF} \leq V_{OUT} \leq (V_{IN} - 1V)$, $4.3V \leq V_{IN} \leq 26V$, $5mA < I_L \leq 750mA$, $T_J \leq T_{JMAX}$.

Note 9: Comparator thresholds are expressed in terms of a voltage differential at the Adjust terminal below the nominal reference voltage measured at 6V input (for a 5V regulator). To express these thresholds in terms of output voltage change, multiply by the error amplifier gain = $V_{OUT} / V_{REF} = (R1 + R2) / R2$. For example, at a programmed output voltage of 5V, the Error output is guaranteed to go low when the output drops by $95mV \times 5V / 1.235V = 384mV$. Thresholds remain constant as a percent of V_{OUT} as V_{OUT} is varied, with the dropout warning occurring at typically 5% below nominal, 7.7% guaranteed.

Note 10: Circuit of Figure 3 with $R1 \geq 150k\Omega$, $V_{SHUTDOWN} \geq 2V$ and $V_{IN} \leq 26V, V_{OUT} = 0$.

Note 11: When used in dual supply systems where the regulator load is returned to a negative supply, the output voltage must be diode clamped to ground.

Note 12: Maximum positive supply voltage of 60V must be of limited duration (< 100ms) and duty cycle ($\leq 1\%$). The maximum continuous supply voltage is 26V.

Schematic Diagram

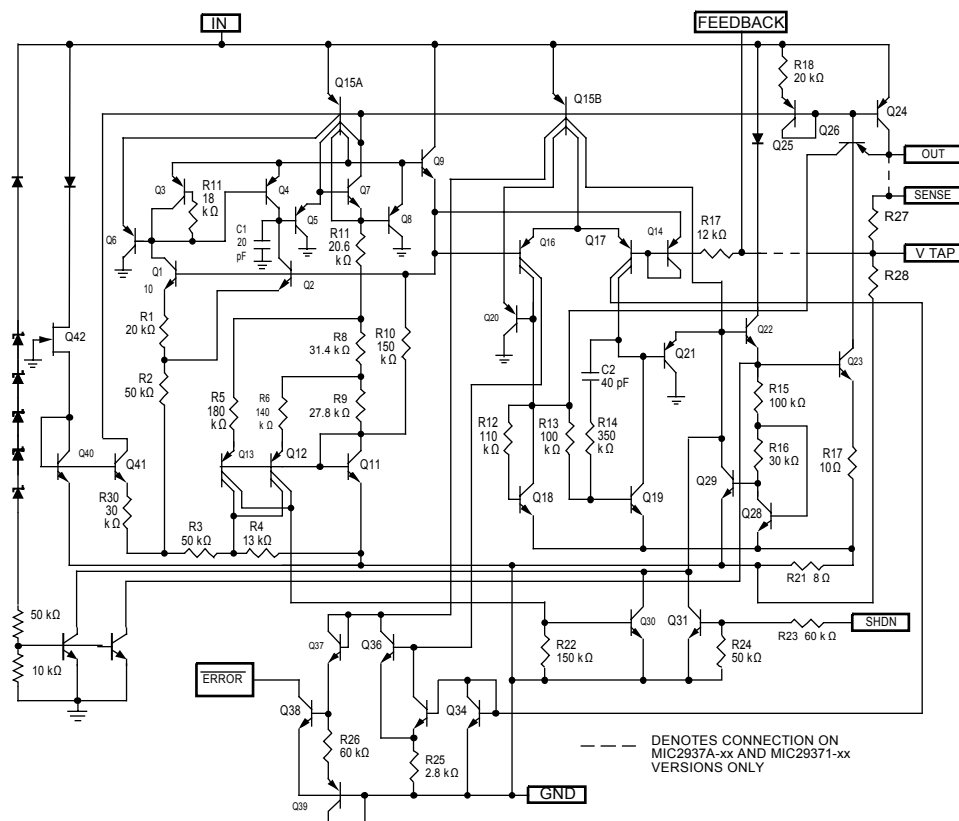

Typical Characteristics

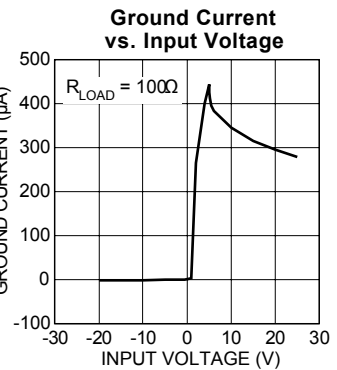
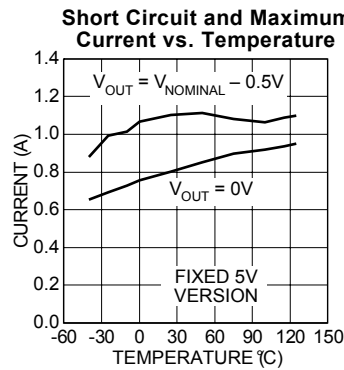
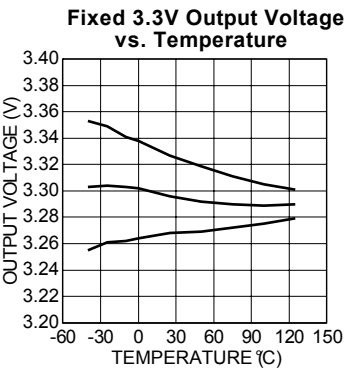
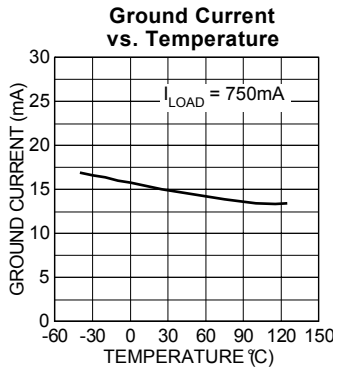
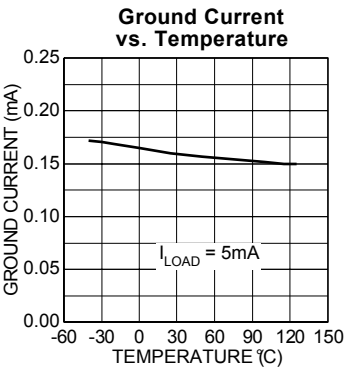
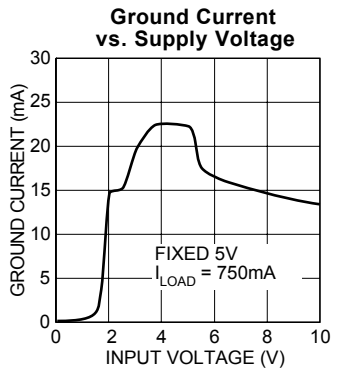
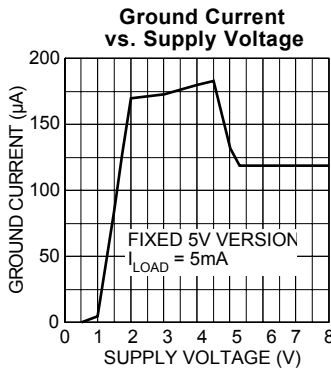
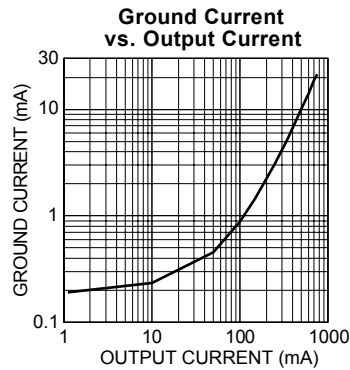
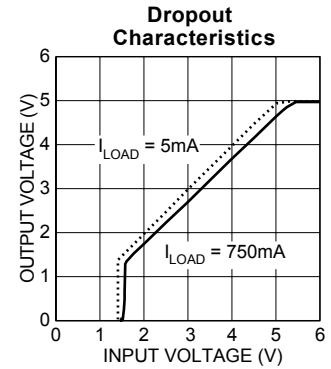
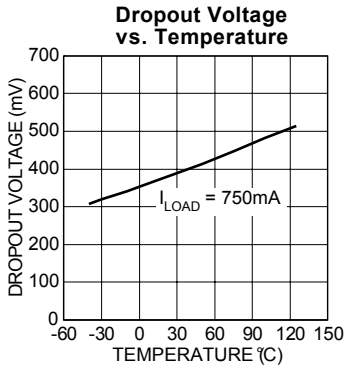
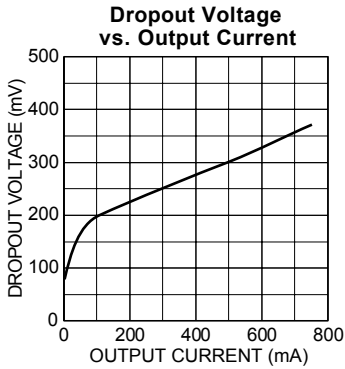

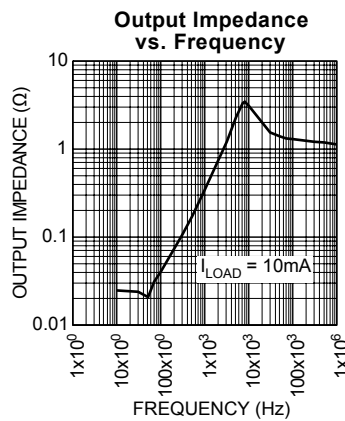
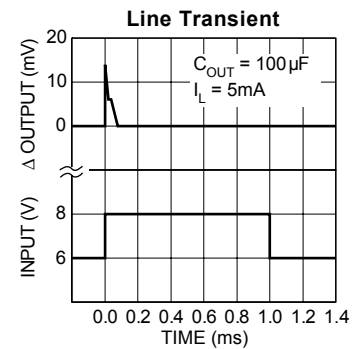
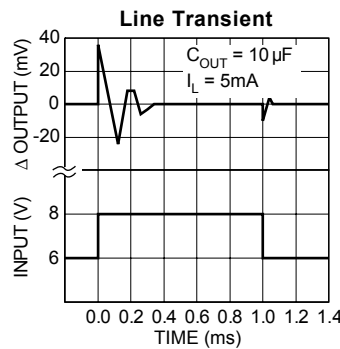

Applications Information

External Capacitors

A 10 μ F (or greater) capacitor is required between the MIC2937A output and ground to prevent oscillations due to instability. Most types of tantalum or aluminum electrolytics will be adequate; film types will work, but are costly and therefore not recommended. Many aluminum electrolytics have electrolytes that freeze at about -30°C , so solid tantalums are recommended for operation below -25°C . The important parameters of the capacitor are an effective series resistance of about 5 Ω or less and a resonant frequency above 500kHz. The value of this capacitor may be increased without limit.

At lower values of output current, less output capacitance is required for output stability. The capacitor can be reduced to 0.5 μ F for current below 10mA or 0.15 μ F for currents below 1 mA. Adjusting the MIC29372 to voltages below 5V runs the error amplifier at lower gains so that more output capacitance is needed. For the worst-case situation of a 750mA load at 1.23V output (Output shorted to Adjust) a 22 μ F (or greater) capacitor should be used.

The MIC2937A/29371 will remain in regulation with a minimum load of 5mA. When setting the output voltage of the MIC29372 version with external resistors, the current through these resistors may be included as a portion of the minimum load.

A 0.1 μ F capacitor should be placed from the input to ground if there is more than 10 inches of wire between the input and the AC filter capacitor or if a battery is used as the input.

Error Detection Comparator Output (MIC29371)

A logic low output will be produced by the comparator whenever the MIC29371 output falls out of regulation by more than approximately 5%. This figure is the comparator's built-in offset of about 75mV divided by the 1.235V reference voltage. (Refer to the block diagram on Page 1). This trip level remains "5% below normal" regardless of the programmed output voltage of the MIC29371. For example, the error flag trip level is typically 4.75V for a 5V output or 11.4V for a 12V output. The out of regulation condition may be due either to low input voltage, extremely high input voltage, current limiting, or thermal limiting.

Figure 1 is a timing diagram depicting the $\overline{\text{ERROR}}$ signal and the regulated output voltage as the MIC29371 input is ramped up and down. The $\overline{\text{ERROR}}$ signal becomes valid (low) at about 1.3V input. It goes high at about 5V input (the input voltage at which $V_{\text{OUT}} = 4.75$). Since the MIC29371's dropout voltage is load-dependent (see curve in Typical Performance Characteristics), the input voltage trip point (about 5V) will vary with the load current. The output voltage trip point (approximately 4.75V) does not vary with load.

The error comparator has an NPN open-collector output which requires an external pull-up resistor. Depending on system requirements, this resistor may be returned to the 5V output or some other supply voltage. In determining a value for this resistor, note that while the output is rated to sink 250 μ A, this sink current adds to battery drain in a low battery condition. Suggested values range from 100k to 1M Ω . The resistor is not required if this output is unused.

Programming the Output Voltage (MIC29372)

The MIC29372 may be programmed for any output voltage between its 1.235V reference and its 26V maximum rating. An external pair of resistors is required, as shown in Figure 3.

The complete equation for the output voltage is

$$V_{\text{OUT}} = V_{\text{REF}} \times \{ 1 + R_1/R_2 \} - |I_{\text{FB}}| R_1$$

where V_{REF} is the nominal 1.235 reference voltage and I_{FB} is the Adjust pin bias current, nominally 20nA. The minimum recommended load current of 1 μ A forces an upper limit of 1.2M Ω on the value of R_2 , if the regulator must work with no load (a condition often found in CMOS in standby), I_{FB} will produce a -2% typical error in V_{OUT} which may be eliminated at room temperature by trimming R_1 . For better accuracy, choosing $R_2 = 100\text{k}$ reduces this error to 0.17% while increasing the resistor program current to 12 μ A. Since the MIC29372 typically draws 100 μ A at no load with SHUTDOWN open-circuited, this is a negligible addition.

Reducing Output Noise

In reference applications it may be advantageous to reduce the AC noise present at the output. One method is to reduce the regulator bandwidth by increasing the size of the output capacitor. This is relatively inefficient, as increasing the capacitor from 1 μ F to 220 μ F only decreases the noise from 430 μ V to 160 μ V_{RMS} for a 100kHz bandwidth at 5V output. Noise can be reduced by a factor of four with the adjustable regulators



* SEE APPLICATIONS INFORMATION

Figure 1. $\overline{\text{ERROR}}$ Output Timing

with a bypass capacitor across R_1 , since it reduces the high frequency gain from 4 to unity. Pick

$$C_{\text{BYPASS}} \cong \frac{1}{2\pi R_1 \cdot 200 \text{ Hz}}$$

or about $0.01\mu\text{F}$. When doing this, the output capacitor must be increased to $10\mu\text{F}$ to maintain stability. These changes reduce the output noise from $430\mu\text{V}$ to $100\mu\text{V}_{\text{RMS}}$ for a 100 kHz bandwidth at 5V output. With the bypass capacitor added, noise no longer scales with output voltage so that improvements are more dramatic at higher output voltages.

Automotive Applications

The MIC2937A is ideally suited for automotive applications for a variety of reasons. It will operate over a wide range of input voltages with very low dropout voltages (40mV at light loads), and very low quiescent currents ($100\mu\text{A}$ typical). These features are necessary for use in battery powered systems, such as automobiles. It is a "bulletproof" device with the ability to survive both reverse battery (negative transients up to 20V below ground), and load dump (positive transients up to 60V) conditions. A wide operating temperature range with low temperature coefficients is yet another reason to use these versatile regulators in automotive designs.

Typical Applications



Figure 2. MIC2937A-5.0 Fixed +5V Regulator

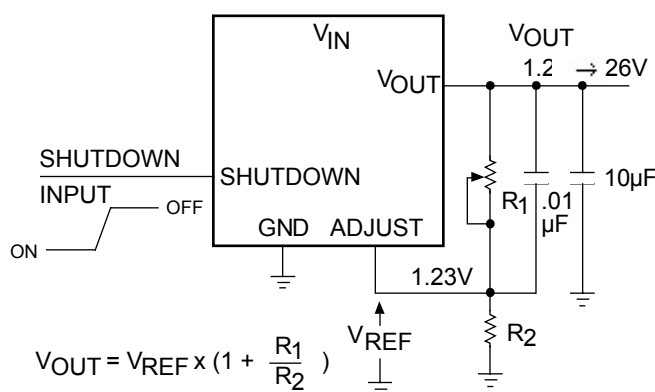
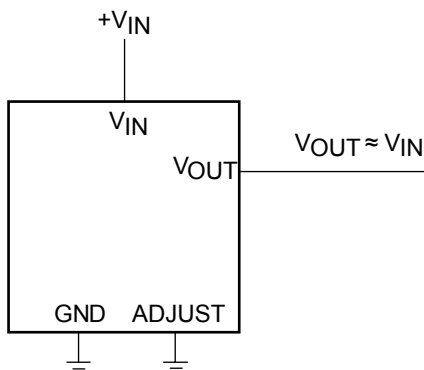
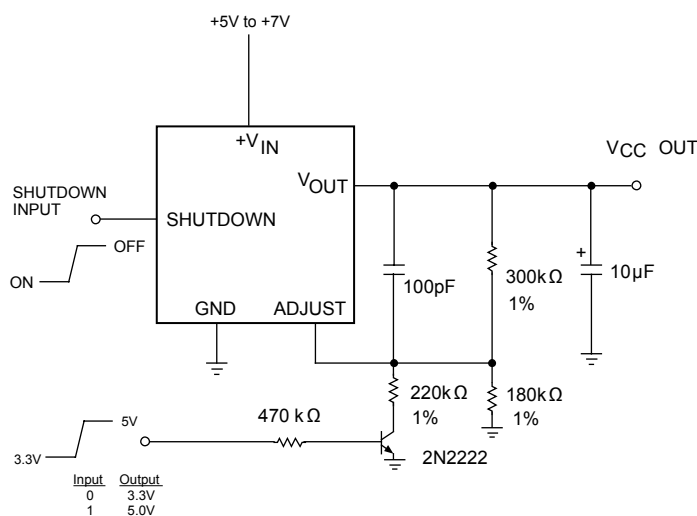

Figure 3. MIC29372 Adjustable Regulator



*MINIMUM INPUT-OUTPUT VOLTAGE RANGES FROM 40mV TO 400mV, DEPENDING ON LOAD CURRENT.

Figure 4. MIC29372 Wide Input Voltage Range Current Limiter



SHUTDOWN PIN LOW= ENABLE OUTPUT. Q1 ON = 3.3V, Q1 OFF = 5.0V.

Figure 5. MIC29372 5.0V or 3.3V Selectable Regulator with Shutdown.

Package Information



PDS	INCH		MM	
	MIN	MAX	MIN	MAX
A	0.171	0.181	4.343	4.597
A1	0.000	0.012	0.000	0.305
b1	0.047	0.053	1.194	1.346
C1	0.012	0.018	0.305	0.457
D	0.351	0.361	8.915	9.169
E	0.400	0.420	10.160	10.668
e	0.095	0.105	2.413	2.667
F	0.045	0.055	1.143	1.397
H	0.575	0.625	14.605	15.875
J1	0.080	0.120	2.032	3.048
L1	0.090	0.110	2.286	2.794
K	0.045	0.055	1.143	1.397
theta1	3°	10°	3°	10°
theta2	1°	7°	1°	7°
theta3	0°	8°	0°	8°
theta4	18°	22°	18°	22°
Q	0.055	0.075	1.397	1.905
U	0.256	Ref.	6.502	Ref.
V	0.303	Ref.	7.696	Ref.

NOTE:
FOOT LENGTH USING GAUGE PLANE
METHOD MEASUREMENT 0.010".

3-Pin TO-263 (U)



PDS	INCH	
	MIN	MAX
A	0.160	0.190
b	0.025	0.040
b1	0.045	0.060
C1	0.012	0.022
D	0.351	0.361
E	0.385	0.420
e	0.090	0.110
F	0.045	0.055
H1	0.560	0.595
J1	0.080	0.120
øP	0.146	0.156
Q	0.103	0.113
L	0.500	0.580
q1	3°	10°
q2	1°	7°
U	0.256	Ref.
V	0.486	Ref.

Note : Foot Length using gauge plane
method measurement 0.010".

3-Pin TO-220 (T)

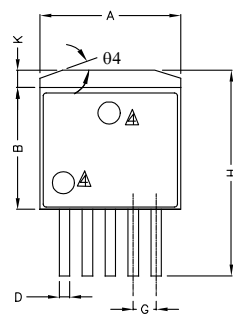

TOP VIEW

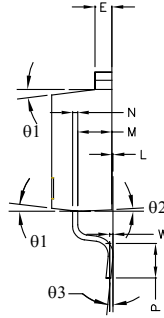

SIDE VIEW 1

POS	INCH		MM	
	MIN	MAX	MIN	MAX
A	0.396	0.420	10.058	10.668
B	0.330	0.361	8.382	9.169
C	0.170	0.181	4.318	4.597
D	0.026	0.036	0.660	0.914
E	0.045	0.055	1.143	1.397
G	0.067	Ref.	1.70	Ref.
H	0.575	0.625	14.605	15.875
K	0.045	0.066	1.143	1.676
L	0	0.012	0	0.305
M	0.080	0.120	2.032	3.048
N	0.012	0.023	0.305	0.584
P	0.090	.0110	2.286	2.794
theta1	3°	10°	3°	10°
theta2	1°	7°	1°	7°
theta3	0°	8°	0°	8°
theta4	18°	22°	18°	22°
U	0.300	Ref.	7.620	Ref.
V	0.305	Ref.	7.747	Ref.
W	0.010	Ref.	0.254	Ref.

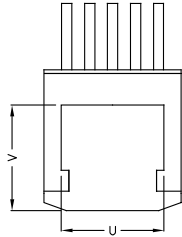

BOTTOM VIEW

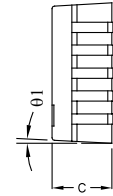

SIDE VIEW 2

NOTE:
 1. PACKAGE OUTLINE EXCLUSIVE OF MOLD FLASH & METAL BURR.
 2. PACKAGE OUTLINE INCLUSIVE OF PLATING THICKNESS.
 3. FOOT LENGTH MEASURED AT INTERCEPT POINT BETWEEN DATUM A & LEAD SURFACE
 ▲ PACKAGE TOP MARK MAY BE IN TOP CENTER OR LOWER LEFT CORNER

5-Pin TO-263 (U)

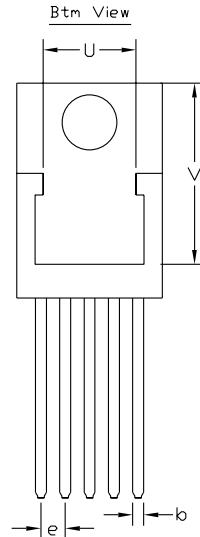
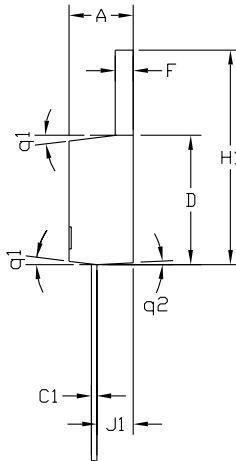
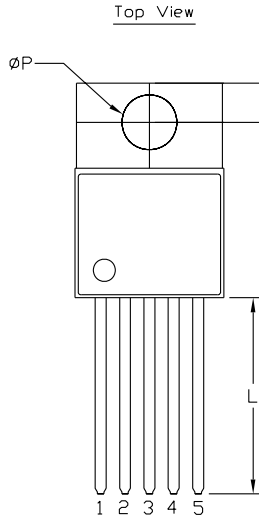

POS	INCH	
	MIN	MAX
A	0.160	0.190
b	0.025	0.040
C1	0.012	0.022
D	0.351	0.361
E	0.385	0.420
e	0.062	0.072
F	0.045	0.055
H1	0.560	0.595
J1	0.080	0.120
øP	0.146	0.156
Q	0.103	0.113
L	0.500	0.580
q1	3°	10°
q2	1°	7°
U	0.256	Ref.
V	0.486	Ref.

Note : Foot Length using gauge plane method measurement 0.010".

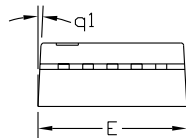

5-Pin TO-220 (T)

MICREL INC. 2180 FORTUNE DRIVE SAN JOSE, CA 95131 USA
TEL + 1 (408) 944-0800 FAX + 1 (408) 474-1000 WEB <http://www.micrel.com>

This information furnished by Micrel in this data sheet is believed to be accurate and reliable. However no responsibility is assumed by Micrel for its use.
Micrel reserves the right to change circuitry and specifications at any time without notification to the customer.

Micrel Products are not designed or authorized for use as components in life support appliances, devices or systems where malfunction of a product can reasonably be expected to result in personal injury. Life support devices or systems are devices or systems that (a) are intended for surgical implant into the body or (b) support or sustain life, and whose failure to perform can be reasonably expected to result in a significant injury to the user. A Purchaser's use or sale of Micrel Products for use in life support appliances, devices or systems is a Purchaser's own risk and Purchaser agrees to fully indemnify Micrel for any damages resulting from such use or sale.

© 1999 Micrel, Inc.

Looking for pricing, stock, or lifecycle information?

Click below to explore more details on WIN SOURCE:

- ⊖ [View MIC29371-5.0BU on WIN SOURCE](#)
- ⊖ [Microchip Technology](#) Information

Optimize Your Supply Chain with WIN SOURCE Solutions

- ✓ Global Sourcing Solution
- ✓ Obsolete Management
- ✓ Cost Control Management
- ✓ Shortage Management
- ✓ Alternative Solution
- ✓ Excess Inventory Management