



**THE DATASHEET OF  
MIC3975-2.5YMM**



### General Description

The MIC3975 is a 750mA low-dropout linear voltage regulators that provide low-voltage, high-current output from an extremely small package. Utilizing Micrel's proprietary Super beta PNP™ pass element, the MIC3975 offers extremely low dropout (typically 300mV at 750mA) and low ground current (typically 6.5mA at 750mA).

The MIC3975 is ideal for PC add-in cards that need to convert from standard 5V to 3.3V or 3.0V, 3.3V to 2.5V or 2.5V to 1.8V or 1.65V. A guaranteed maximum dropout voltage of 500mV over all operating conditions allows the MIC3975 to provide 2.5V from a supply as low as 3.0V and 1.8V or 1.65V from a supply as low as 2.25V.

The MIC3975 is fully protected with overcurrent limiting, thermal shutdown, and reversed-battery protection. Fixed voltages of 5.0V, 3.3V, 3.0, 2.5V, 1.8V, and 1.65V are available. An adjustable output voltage option is available for voltages down to 1.24V.

For other voltages, contact Micrel.

### Features

- Fixed and adjustable output voltages to 1.24V
- 300mV typical dropout at 750mA
  - Ideal for 3.0V to 2.5V conversion
  - Ideal for 2.5V to 1.8V or 1.65V conversion
- Stable with ceramic capacitor
- 750mA minimum guaranteed output current
- 1% initial accuracy
- Low ground current
- Current limiting and thermal shutdown
- Reversed-battery protection
- Reversed-leakage protection
- Fast transient response
- Low-profile MSOP-8

### Applications

- Fiber optic modules
- LDO linear regulator for PC add-in cards
- PowerPC™ power supplies
- High-efficiency linear power supplies
- SMPS post regulator
- Multimedia and PC processor supplies
- Battery chargers
- Low-voltage microcontrollers and digital logic

### Ordering Information

Part Number		Voltage	Junction Temp. Range	Package
Standard	Pb-Free			
MIC3975-1.65BMM	MIC3975-1.65YMM	1.65V	-40°C to +125°C	MSOP-8
MIC3975-1.8BMM	MIC3975-1.8YMM	1.8V	-40°C to +125°C	MSOP-8
MIC3975-2.5BMM	MIC3975-2.5YMM	2.5V	-40°C to +125°C	MSOP-8
MIC3975-3.0BMM	MIC3975-3.0YMM	3.0V	-40°C to +125°C	MSOP-8
MIC3975-3.3BMM	MIC3975-3.3YMM	3.3V	-40°C to +125°C	MSOP-8
MIC3975-5.0BMM	MIC3975-5.0YMM	5.0V	-40°C to +125°C	MSOP-8
MIC3975BMM	MIC3975YMM	Adj.	-40°C to +125°C	MSOP-8

### Typical Applications

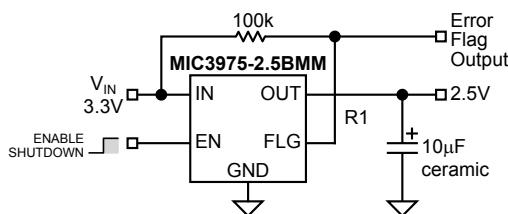

**2.5V/750mA Regulator with Error Flag**

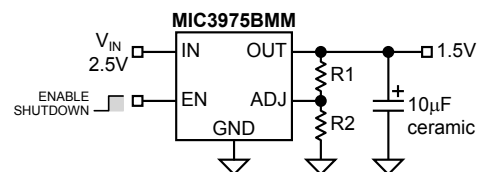

**1.5V/750mA Adjustable Regulator**

Super beta PNP is a trademark of Micrel, Inc.

Micrel, Inc. • 2180 Fortune Drive • San Jose, CA 95131 • USA • tel + 1 (408) 944-0800 • fax + 1 (408) 474-1000 • <http://www.micrel.com>

## Pin Configuration

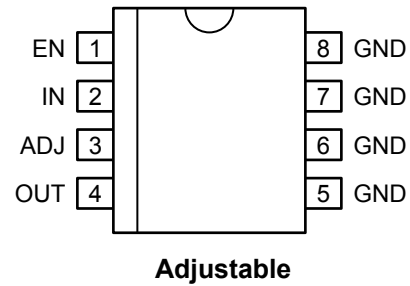
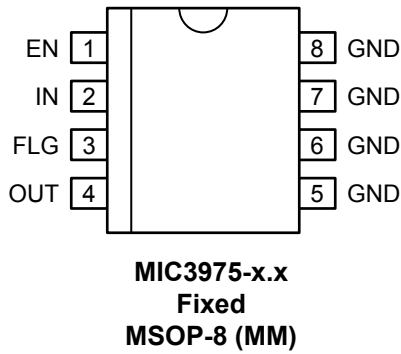

## Pin Description

Pin No. Fixed	Pin No. Adjustable	Pin Name	Pin Function
1	1	EN	Enable (Input): CMOS-compatible control input. Logic high = enable, logic low or open = shutdown.
2	2	IN	Supply (Input)
3		FLG	Flag (Output): Open-collector error flag output. Active low = output under-voltage.
	3	ADJ	Adjustment Input: Feedback input. Connect to resistive voltage-divider network.
4	4	OUT	Regulator Output
5-8	5-8	GND	Ground

**Absolute Maximum Ratings (Note 1)**

Supply Voltage ( $V_{IN}$ )	-20V to +20V
Enable Voltage ( $V_{EN}$ )	+20V
Storage Temperature ( $T_S$ )	-65°C to +150°C
Lead Temperature (soldering, 5 sec.)	260°C
ESD, <b>Note 3</b>	

**Operating Ratings (Note 2)**

Supply Voltage ( $V_{IN}$ )	+2.25V to +16V
Enable Voltage ( $V_{EN}$ )	+16V
Maximum Power Dissipation ( $P_{D(max)}$ )	<b>Note 4</b>
Junction Temperature ( $T_J$ )	-40°C to +125°C
Package Thermal Resistance	
MSOP-8 ( $\theta_{JA}$ )	80°C/W

**Electrical Characteristics (Note 12)**

$V_{IN} = V_{OUT} + 1V$ ;  $V_{EN} = 2.25V$ ;  $T_J = 25^\circ C$ , **bold** values indicate  $-40^\circ C \leq T_J \leq +125^\circ C$ ; unless noted

Symbol	Parameter	Condition	Min	Typ	Max	Units
$V_{OUT}$	Output Voltage	10mA	-1		1	%
		$10mA \leq I_{OUT} \leq 750mA$ , $V_{OUT} + 1V \leq V_{IN} \leq 8V$	<b>-2</b>		<b>2</b>	%
	Line Regulation	$I_{OUT} = 10mA$ , $V_{OUT} + 1V \leq V_{IN} \leq 16V$		0.06	0.5	%
	Load Regulation	$V_{IN} = V_{OUT} + 1V$ , $10mA \leq I_{OUT} \leq 750mA$ ,		0.2	1	%
$\Delta V_{OUT}/\Delta T$ ppm/°C	Output Voltage Temp. Coefficient, <b>Note 5</b>			40	100	
$V_{DO}$	Dropout Voltage, <b>Note 6</b>	$I_{OUT} = 100mA$ , $\Delta V_{OUT} = -1\%$		140	200	mV
		$I_{OUT} = 500mA$ , $\Delta V_{OUT} = -1\%$		225	<b>250</b>	mV
		$I_{OUT} = 750mA$ , $\Delta V_{OUT} = -1\%$		300	<b>500</b>	<b>mV</b>
$I_{GND}$	Ground Current, <b>Note 7</b>	$I_{OUT} = 100mA$ , $V_{IN} = V_{OUT} + 1V$		400		$\mu A$
		$I_{OUT} = 500mA$ , $V_{IN} = V_{OUT} + 1V$		4		mA
		$I_{OUT} = 750mA$ , $V_{IN} = V_{OUT} + 1V$		7.5	<b>15</b>	<b>mA</b>
$I_{OUT(lim)}$	<b>Current Limit</b>	<b><math>V_{OUT} = 0V</math>, <math>V_{IN} = V_{OUT} + 1V</math></b>		<b>1.8</b>	<b>2.5</b>	<b>A</b>
<b>Enable Input</b>						
$V_{EN}$	Enable Input Voltage	logic low (off)			<b>0.8</b>	<b>V</b>
		logic high (on)	<b>2.25</b>			<b>V</b>
$I_{EN}$	Enable Input Current	$V_{EN} = 2.25V$	1	15	30	$\mu A$
		$V_{EN} = 0.8V$			<b>75</b>	<b><math>\mu A</math></b>
					2	$\mu A$
					<b>4</b>	<b><math>\mu A</math></b>
<b>Flag Output</b>						
$I_{FLG(leak)}$	Output Leakage Current	$V_{OH} = 16V$		0.01	1	$\mu A$
					<b>2</b>	$\mu A$
$V_{FLG(do)}$	Output Low Voltage	$V_{IN} = 2.250V$ , $I_{OL} = 250\mu A$ , <b>Note 9</b>		210	300	mV
					<b>400</b>	<b>mV</b>
$V_{FLG}$	Low Threshold	% of $V_{OUT}$	93			%
	High Threshold	% of $V_{OUT}$			99.2	%
	Hysteresis			1		%

Symbol	Parameter	Condition	Min	Typ	Max	Units
<b>Adjustable Output Only</b>						
	Reference Voltage	<b>Note 10</b>	1.228	1.240	1.252	V
			1.215		1.265	V
			1.203		1.277	V
	Adjust Pin Bias Current			40	80 120	nA nA
ppm/°C	Reference Voltage	<b>Note 11</b>		20		
	Temp. Coefficient					
	Adjust Pin Bias Current Temp. Coefficient			0.1		nA/°C

**Note 1.** Exceeding the absolute maximum ratings may damage the device.

**Note 2.** The device is not guaranteed to function outside its operating rating.

**Note 3.** Devices are ESD sensitive. Handling precautions recommended.

**Note 4.**  $P_{D(max)} = (T_{J(max)} - T_A) \div \theta_{JA}$ , where  $\theta_{JA}$  depends upon the printed circuit layout. See "Applications Information."

**Note 5.** Output voltage temperature coefficient is  $\Delta V_{OUT(worst\ case)} \div (T_{J(max)} - T_{J(min)})$  where  $T_{J(max)}$  is +125°C and  $T_{J(min)}$  is -40°C.

**Note 6.**  $V_{DO} = V_{IN} - V_{OUT}$  when  $V_{OUT}$  decreases to 98% of its nominal output voltage with  $V_{IN} = V_{OUT} + 1V$ . For output voltages below 2.25V, dropout voltage is the input-to-output voltage differential with the minimum input voltage being 2.25V. Minimum input operating voltage is 2.25V.

**Note 7.**  $I_{GND}$  is the quiescent current.  $I_{IN} = I_{GND} + I_{OUT}$ .

**Note 8.**  $V_{EN} \leq 0.8V$ ,  $V_{IN} \leq 8V$ , and  $V_{OUT} = 0V$ .

**Note 9.** For a 2.5V device,  $V_{IN} = 2.250V$  (device is in dropout).

**Note 10.**  $V_{REF} \leq V_{OUT} \leq (V_{IN} - 1V)$ ,  $2.25V \leq V_{IN} \leq 16V$ ,  $10mA \leq I_L \leq 750mA$ ,  $T_J = T_{MAX}$ .

**Note 11.** Thermal regulation is defined as the change in output voltage at a time  $t$  after a change in power dissipation is applied, excluding load or line regulation effects. Specifications are for a 200mA load pulse at  $V_{IN} = 16V$  for  $t = 10ms$ .

**Note 12.** Specification for packaged product only.

# Typical Characteristics

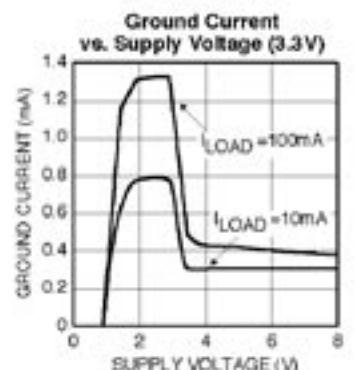
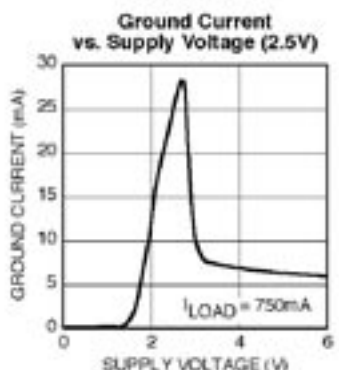
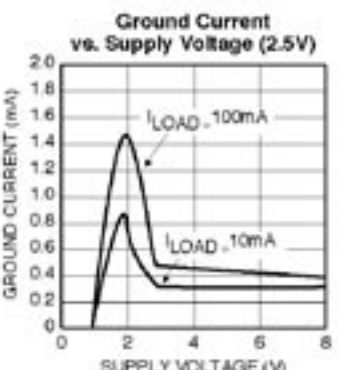
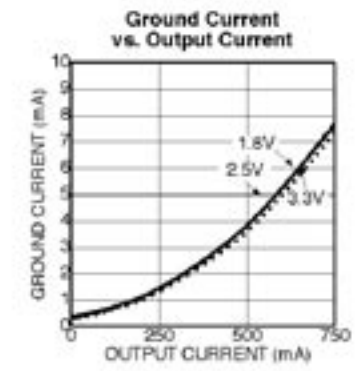
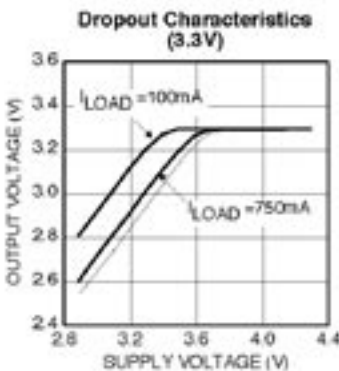
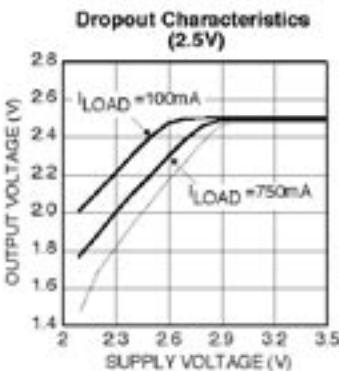
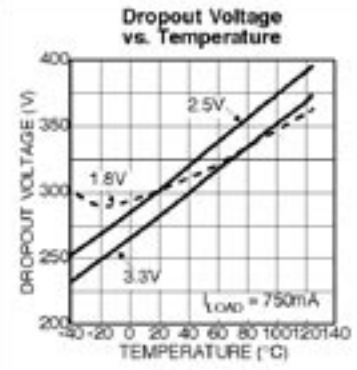
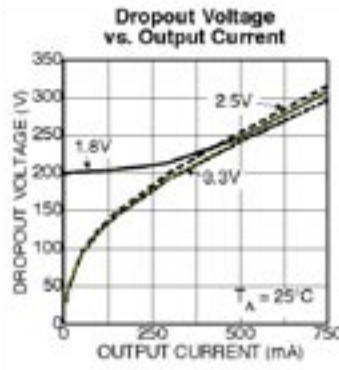
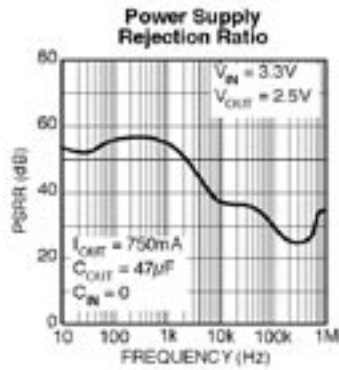
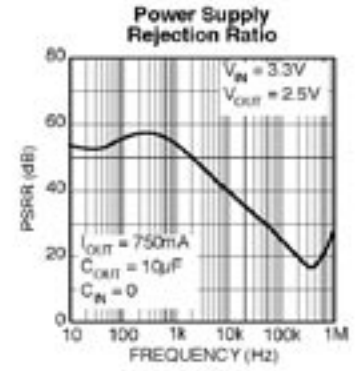
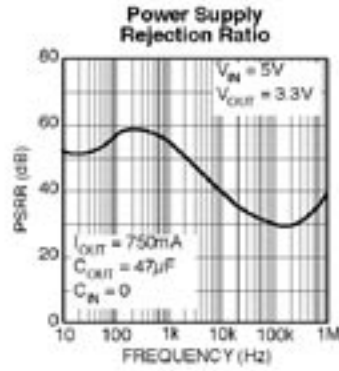
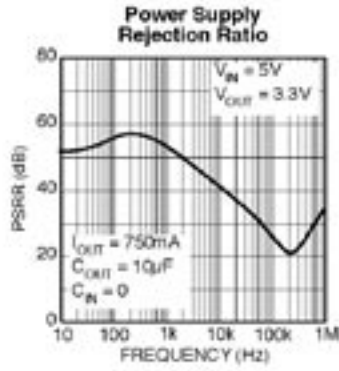

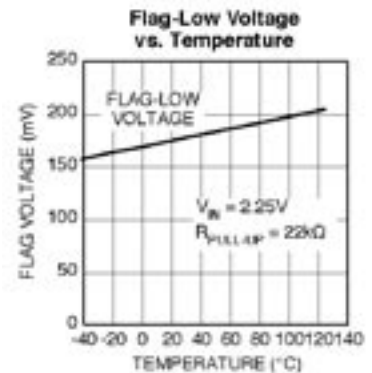
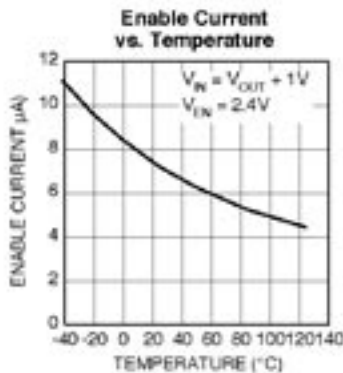
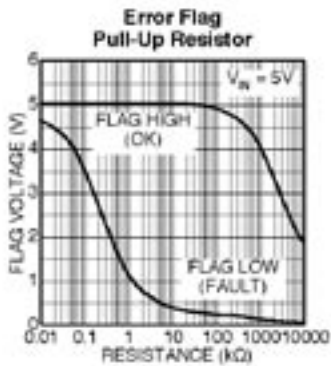
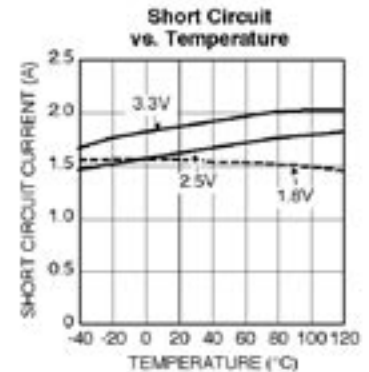
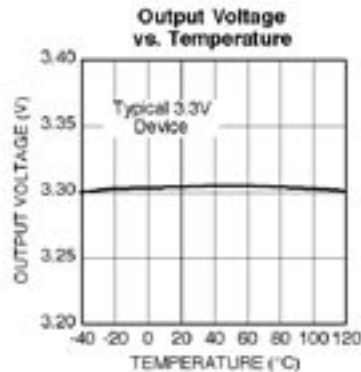
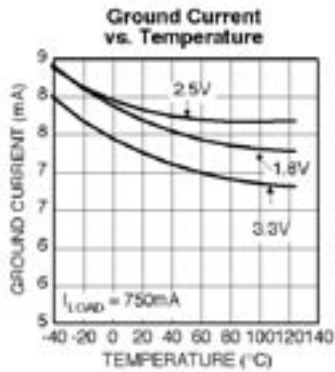
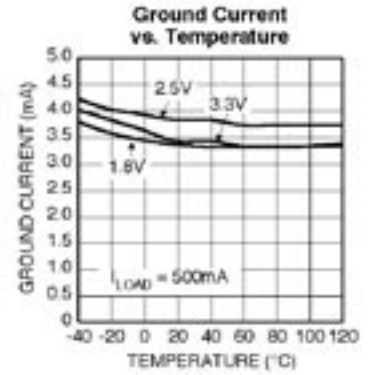
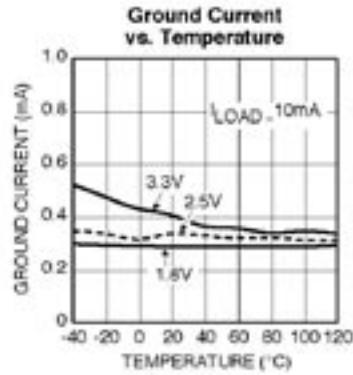
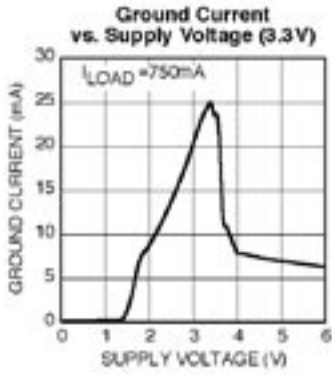

# Functional Characteristics

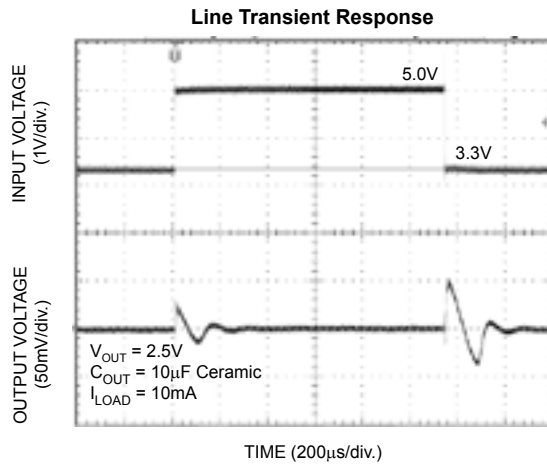
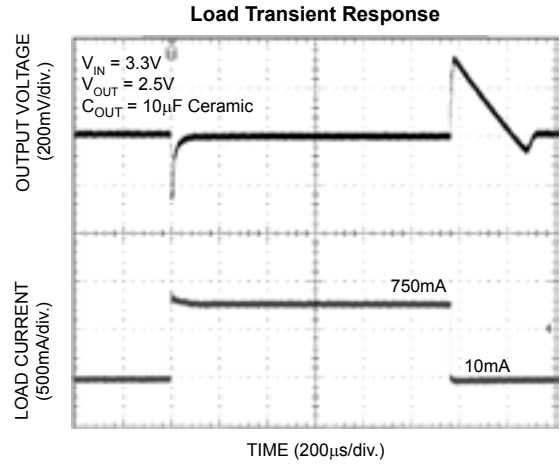
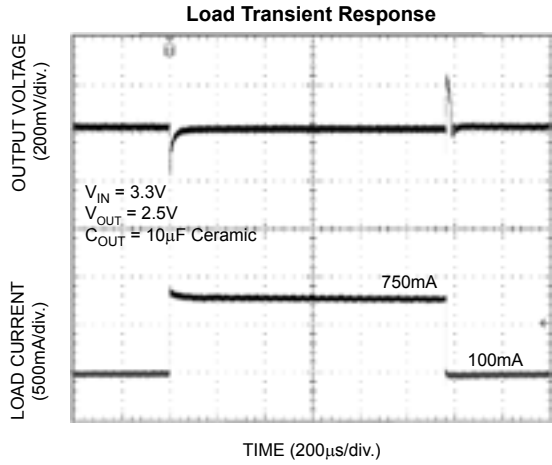

# Functional Diagrams

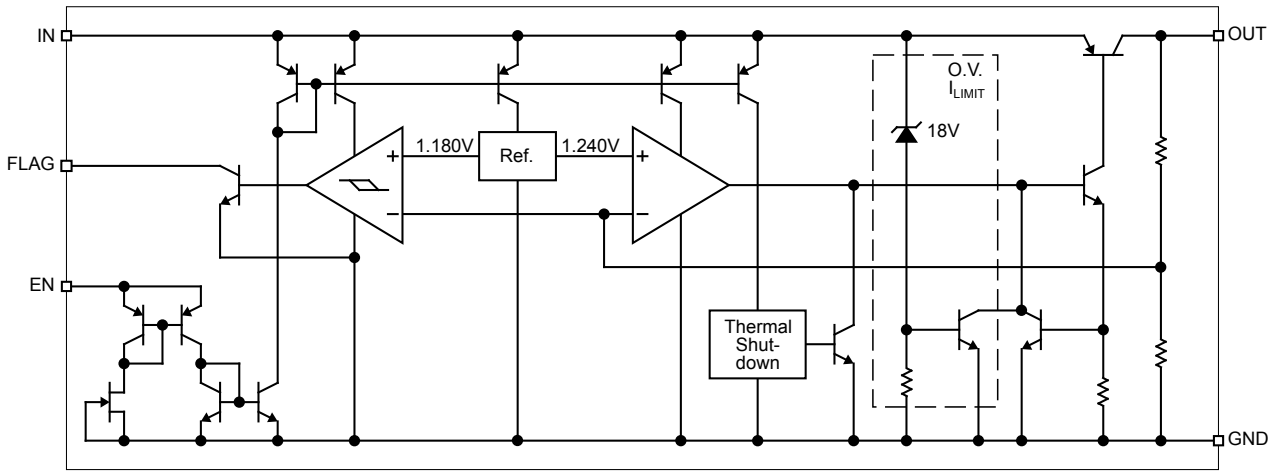

**MIC3975 Fixed Regulator with Flag and Enable Block Diagram**

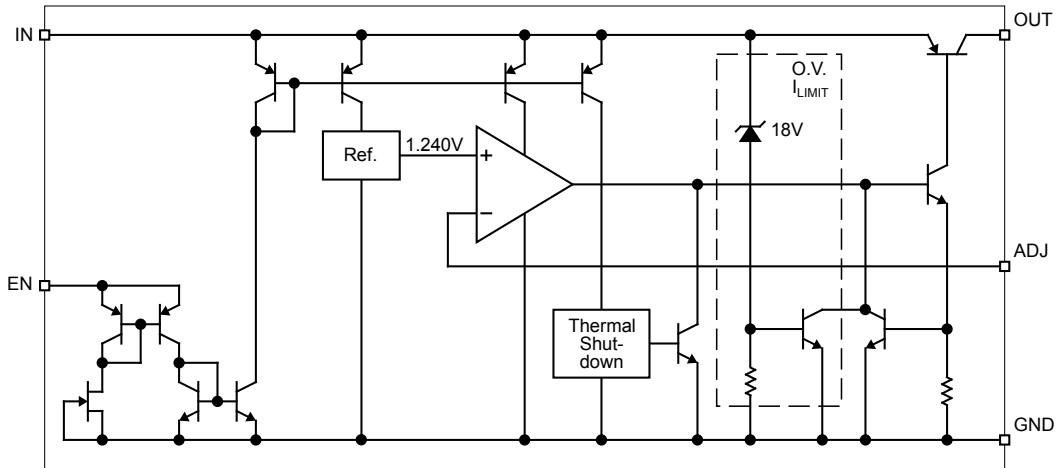

**MIC3975 Adjustable Regulator Block Diagram**

## Applications Information

The MIC3975 is a high-performance low-dropout voltage regulator suitable for moderate to high-current voltage regulator applications. Its 500mV dropout voltage at full load and over-temperature makes it especially valuable in battery-powered systems and as high-efficiency noise filters in post-regulator applications. Unlike older NPN-pass transistor designs, where the minimum dropout voltage is limited by the base-to-emitter voltage drop and collector-to-emitter saturation voltage, dropout performance of the PNP output of these devices is limited only by the low  $V_{CE}$  saturation voltage.

A trade-off for the low dropout voltage is a varying base drive requirement. Micrel's Super  $\beta$  PNP™ process reduces this drive requirement to only 2% of the load current.

The MIC3975 regulator is fully protected from damage due to fault conditions. Linear current limiting is provided. Output current during overload conditions is constant. Thermal shutdown disables the device when the die temperature exceeds the maximum safe operating temperature. Transient protection allows device (and load) survival even when the input voltage spikes above and below nominal. The output structure of these regulators allows voltages in excess of the desired output voltage to be applied without reverse current flow.

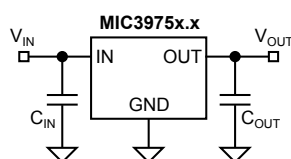

Figure 1. Capacitor Requirements

### Output Capacitor

The MIC3975 requires an output capacitor for stable operation. As a  $\mu$ Cap LDO, the MIC3975 can operate with ceramic output capacitors as long as the amount of capacitance is  $10\mu\text{F}$  or greater. For values of output capacitance lower than  $10\mu\text{F}$ , the recommended ESR range is  $200\text{m}\Omega$  to  $2\Omega$ . The minimum value of output capacitance recommended for the MIC3975 is  $4.7\mu\text{F}$ .

For  $10\mu\text{F}$  or greater the ESR range recommended is less than  $1\Omega$ . Ultra-low ESR ceramic capacitors are recommended for output capacitance of  $10\mu\text{F}$  or greater to help improve transient response and noise reduction at high frequency. X7R/X5R dielectric-type ceramic capacitors are recommended because of their temperature performance. X7R-type capacitors change capacitance by 15% over their operating temperature range and are the most stable type of ceramic capacitors. Z5U and Y5V dielectric capacitors change value by as much as 50% and 60% respectively over their operating temperature ranges. To use a ceramic chip capacitor with Y5V dielectric, the value must be much higher than an X7R ceramic capacitor to ensure the same minimum capacitance over the equivalent operating temperature range.

### Input Capacitor

An input capacitor of  $1\mu\text{F}$  or greater is recommended when the device is more than 4 inches away from the bulk ac supply capacitance or when the supply is a battery. Small, surface mount, ceramic chip capacitors can be used for bypassing. Larger values will help to improve ripple rejection by bypassing the input to the regulator, further improving the integrity of the output voltage.

### Error Flag

The MIC3975 features an error flag (FLG), which monitors the output voltage and signals an error condition when this voltage drops 5% below its expected value. The error flag is an open-collector output that pulls low under fault conditions and may sink up to 10mA. Low output voltage signifies a number of possible problems, including an overcurrent fault (the device is in current limit) or low input voltage. The flag output is inoperative during overtemperature conditions. A pull-up resistor from FLG to either  $V_{IN}$  or  $V_{OUT}$  is required for proper operation. For information regarding the minimum and maximum values of pull-up resistance, refer to the graph in the typical characteristics section of the data sheet.

### Enable Input

The MIC3975 features an active-high enable input (EN) that allows on-off control of the regulator. Current drain reduces to “zero” when the device is shutdown, with only microamperes of leakage current. The EN input has TTL/CMOS compatible thresholds for simple logic interfacing. EN may be directly tied to  $V_{IN}$  and pulled up to the maximum supply voltage

### Transient Response and 3.3V to 2.5V or 2.5V to 1.8V or 1.65V Conversion

The MIC3975 has excellent transient response to variations in input voltage and load current. The device has been designed to respond quickly to load current variations and input voltage variations. Large output capacitors are not required to obtain this performance. A standard  $10\mu\text{F}$  output capacitor, is all that is required. Larger values help to improve performance even further.

By virtue of its low-dropout voltage, this device does not saturate into dropout as readily as similar NPN-based designs. When converting from 3.3V to 2.5V or 2.5V to 1.8V or 1.65V, the NPN based regulators are already operating in dropout, with typical dropout requirements of 1.2V or greater. To convert down to 2.5V or 1.8V without operating in dropout, NPN-based regulators require an input voltage of 3.7V at the very least. The MIC3975 regulator will provide excellent performance with an input as low as 3.0V or 2.5V respectively. This gives the PNP based regulators a distinct advantage over older, NPN based linear regulators.

### Minimum Load Current

The MIC3975 regulator is specified between finite loads. If the output current is too small, leakage currents dominate and the output voltage rises. A 10mA minimum load current is necessary for proper regulation.

**Adjustable Regulator Design**

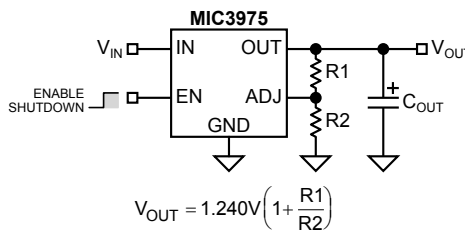

**Figure 2. Adjustable Regulator with Resistors**

The MIC3975 allows programming the output voltage anywhere between 1.24V and the 16V maximum operating rating of the family. Two resistors are used. Resistors can be quite large, up to 1MΩ, because of the very high input impedance and low bias current of the sense comparator: The resistor values are calculated by:

$$R1 = R2 \left( \frac{V_{OUT}}{1.240} - 1 \right)$$

Where  $V_O$  is the desired output voltage. Figure 2 shows component definition. Applications with widely varying load currents may scale the resistors to draw the minimum load current required for proper operation (see above).

**Power MSOP-8 Thermal Characteristics**

One of the secrets of the MIC3975's performance is its power MSO-8 package featuring half the thermal resistance of a standard MSO-8 package. Lower thermal resistance means more output current or higher input voltage for a given package size.

Lower thermal resistance is achieved by joining the four ground leads with the die attach paddle to create a single-piece electrical and thermal conductor. This concept has been used by MOSFET manufacturers for years, proving very reliable and cost effective for the user.

Thermal resistance consists of two main elements,  $\theta_{JC}$  (junction-to-case thermal resistance) and  $\theta_{CA}$  (case-to-ambient thermal resistance). See Figure 3.  $\theta_{JC}$  is the resistance from the die to the leads of the package.  $\theta_{CA}$  is the resistance from the leads to the ambient air and it includes  $\theta_{CS}$  (case-to-sink thermal resistance) and  $\theta_{SA}$  (sink-to-ambient thermal resistance).

Using the power MSOP-8 reduces the  $\theta_{JC}$  dramatically and allows the user to reduce  $\theta_{CA}$ . The total thermal resistance,  $\theta_{JA}$  (junction-to-ambient thermal resistance) is the limiting factor in calculating the maximum power dissipation capability of the device. Typically, the power MSOP-8 has a  $\theta_{JA}$  of 80°C/W, this is significantly lower than the standard MSOP-8 which is typically 160°C/W.  $\theta_{CA}$  is reduced because pins 5 through 8 can now be soldered directly to a ground plane which significantly reduces the case-to-sink thermal resistance and sink to ambient thermal resistance.

Low-dropout linear regulators from Micrel are rated to a maximum junction temperature of 125°C. It is important not to exceed this maximum junction temperature during operation of the device. To prevent this maximum junction temperature from being exceeded, the appropriate ground plane heat sink must be used.

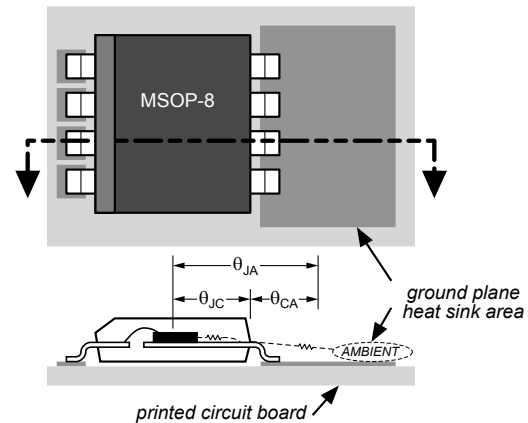

**Figure 3. Thermal Resistance**

Figure 4 shows copper area versus power dissipation with each trace corresponding to a different temperature rise above ambient.

From these curves, the minimum area of copper necessary for the part to operate safely can be determined. The maximum allowable temperature rise must be calculated to determine operation along which curve.

$$\Delta T = T_{J(max)} - T_{A(max)}$$

$$T_{J(max)} = 125^\circ\text{C}$$

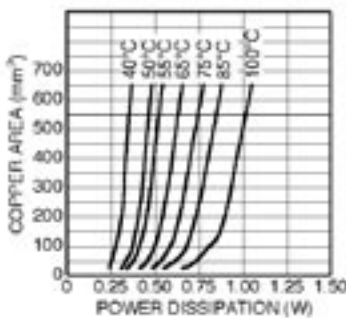

**Figure 4. Copper Area vs. Power-MSOP Power Dissipation ( $\Delta T_{JA}$ )**

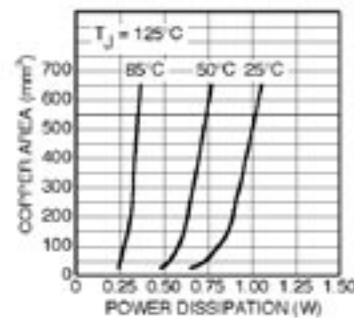

**Figure 5. Copper Area vs. Power-MSOP Power Dissipation ( $T_A$ )**

$T_{A(max)}$  = maximum ambient operating temperature

For example, the maximum ambient temperature is 50°C, the  $\Delta T$  is determined as follows:

$$\Delta T = 125^{\circ}\text{C} - 50^{\circ}\text{C}$$

$$\Delta T = 75^{\circ}\text{C}$$

Using Figure 4, the minimum amount of required copper can be determined based on the required power dissipation. Power dissipation in a linear regulator is calculated as follows:

$$P_D = (V_{IN} - V_{OUT}) I_{OUT} + V_{IN} \times I_{GND}$$

If we use a 2.5V output device and a 3.3V input at an output current of 750mA, then our power dissipation is as follows:

$$P_D = (3.3\text{V} - 2.5\text{V}) \times 750\text{mA} + 3.3\text{V} \times 7.5\text{mA}$$

$$P_D = 600\text{mW} + 25\text{mW}$$

$$P_D = 625\text{mW}$$

From Figure 4, the minimum amount of copper required to operate this application at a  $\Delta T$  of 75°C is 160mm<sup>2</sup>.

#### Quick Method

Determine the power dissipation requirements for the design along with the maximum ambient temperature at which the device will be operated. Refer to Figure 5, which shows safe

operating curves for three different ambient temperatures: 25°C, 50°C and 85°C. From these curves, the minimum amount of copper can be determined by knowing the maximum power dissipation required. If the maximum ambient temperature is 50°C and the power dissipation is as above, 625mW, the curve in Figure 5 shows that the required area of copper is 160mm<sup>2</sup>.

The  $\theta_{JA}$  of this package is ideally 80°C/W, but it will vary depending upon the availability of copper ground plane to which it is attached.

## Package Information

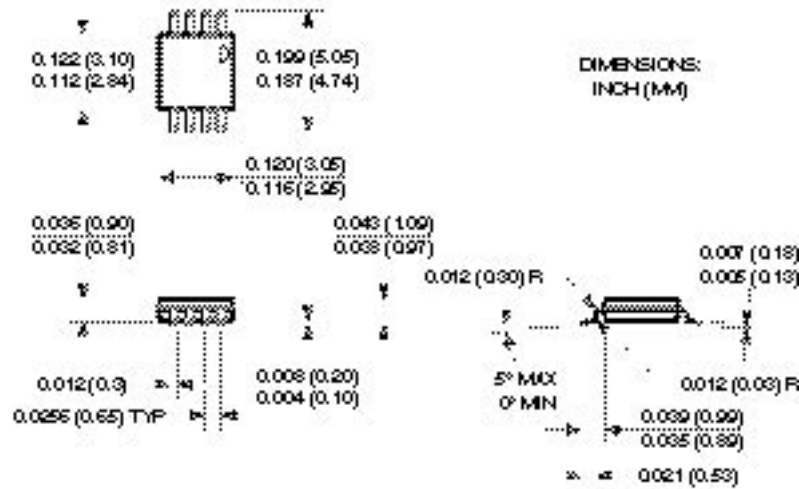

**8-Lead MSOP (MM)**

**MICREL, INC. 2180 FORTUNE DRIVE SAN JOSE, CA 95131 USA**

TEL + 1 (408) 944-0800 FAX + 1 (408) 474-1000 WEB <http://www.micrel.com>

The information furnished by Micrel in this datasheet is believed to be accurate and reliable. However, no responsibility is assumed by Micrel for its use. Micrel reserves the right to change circuitry and specifications at any time without notification to the customer.

Micrel Products are not

reasonably be expected to result in personal injury. Life support devices or systems are devices or systems that (a) are intended for surgical implant into the body or (b) support or sustain life, and whose failure to perform can be reasonably expected to result in a significant injury to the user. A Purchaser's use or sale of Micrel Products for use in life support appliances, devices or systems is at Purchaser's own risk and Purchaser agrees to fully indemnify

Micrel for any damages resulting from such use or sale.

© 2005 Micrel, Incorporated.

## Looking for pricing, stock, or lifecycle information?

Click below to explore more details on WIN SOURCE:

- ⊖ [View MIC3975-2.5YMM on WIN SOURCE](#)
- ⊖ [Microchip Technology](#) Information

## Optimize Your Supply Chain with WIN SOURCE Solutions

- ✓ Global Sourcing Solution
- ✓ Obsolete Management
- ✓ Cost Control Management
- ✓ Shortage Management
- ✓ Alternative Solution
- ✓ Excess Inventory Management