

# 2SD2623

## Silicon NPN epitaxial planar type

For low-frequency amplification

### ■ Features

- Low ON resistance  $R_{on}$
- S-Mini type package, allowing downsizing of the equipment and automatic insertion through the tape packing.

### ■ Absolute Maximum Ratings $T_a = 25^\circ\text{C}$

Parameter	Symbol	Rating	Unit
Collector-base voltage (Emitter open)	$V_{CBO}$	25	V
Collector-emitter voltage (Base open)	$V_{CEO}$	20	V
Emitter-base voltage (Collector open)	$V_{EBO}$	12	V
Collector current	$I_C$	0.5	A
Peak collector current	$I_{CP}$	1	A
Collector power dissipation	$P_C$	150	mW
Junction temperature	$T_j$	150	$^\circ\text{C}$
Storage temperature	$T_{stg}$	-55 to +150	$^\circ\text{C}$

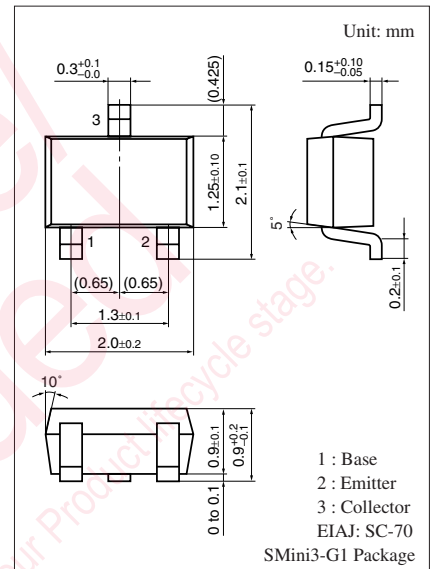

Marking Symbol: 2V

### ■ Electrical Characteristics $T_a = 25^\circ\text{C} \pm 3^\circ\text{C}$

Parameter	Symbol	Conditions	Min	Typ	Max	Unit
Collector-base voltage (Emitter open)	$V_{CBO}$	$I_C = 10 \mu\text{A}$ , $I_E = 0$	25			V
Collector-emitter voltage (Base open)	$V_{CEO}$	$I_C = 1 \text{ mA}$ , $I_B = 0$	20			V
Emitter-base voltage (Collector open)	$V_{EBO}$	$I_E = 10 \mu\text{A}$ , $I_C = 0$	12			V
Collector-base cutoff current (Emitter open)	$I_{CBO}$	$V_{CB} = 25 \text{ V}$ , $I_E = 0$			100	nA
Forward current transfer ratio *1,2	$h_{FE}$	$V_{CE} = 2 \text{ V}$ , $I_C = 0.5 \text{ A}$	200		800	—
Collector-emitter saturation voltage *1	$V_{CE(sat)}$	$I_C = 0.5 \text{ A}$ , $I_B = 20 \text{ mA}$		0.14	0.40	V
Base-emitter saturation voltage *1	$V_{BE(sat)}$	$I_C = 0.5 \text{ A}$ , $I_B = 50 \text{ mA}$			1.2	V
Transition frequency	$f_T$	$V_{CB} = 10 \text{ V}$ , $I_E = -50 \text{ mA}$ , $f = 200 \text{ MHz}$		200		MHz
Collector output capacitance (Common base, input open circuited)	$C_{ob}$	$V_{CB} = 10 \text{ V}$ , $I_E = 0$ , $f = 1 \text{ MHz}$		10		pF
ON resistance *3	$R_{on}$			1.0		$\Omega$

Note) 1. Measuring methods are based on JAPANESE INDUSTRIAL STANDARD JIS C 7030 measuring methods for transistors.

2. \*1: Pulse measurement

\*2: Rank classification

Rank	R	S	T
$h_{FE}$	200 to 350	300 to 500	400 to 800

\*3:  $R_{on}$  Measurement circuit

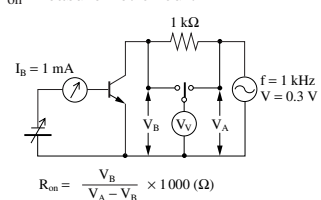

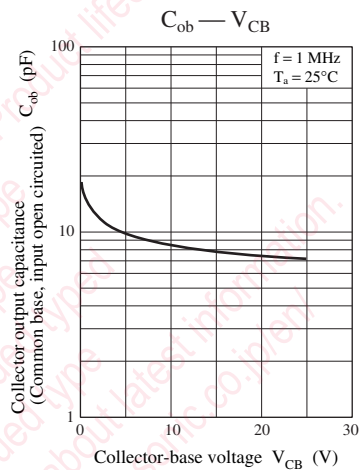
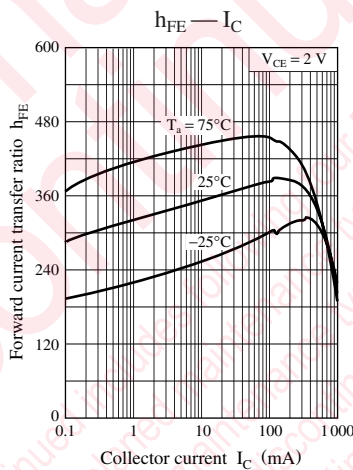
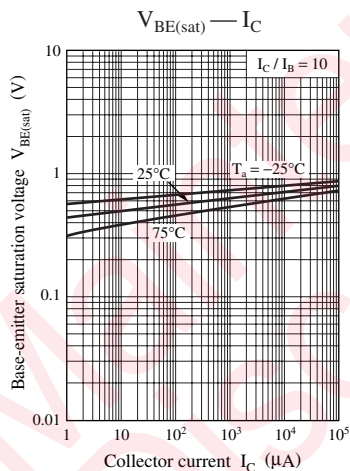
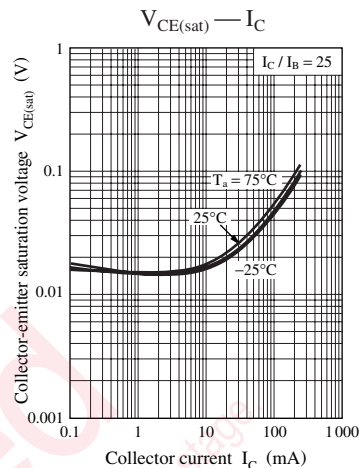
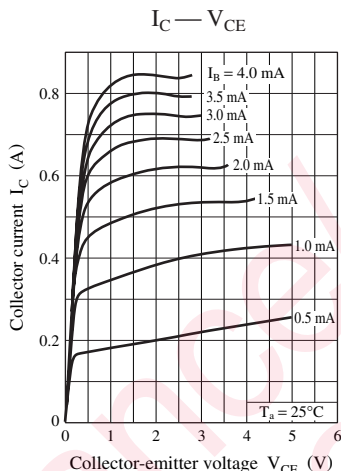
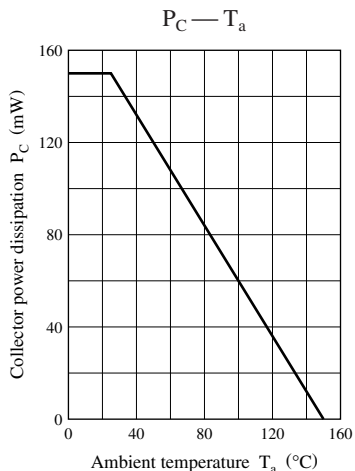

## utions in using the technical information and scribed in this book

s book is to be exported or provided to non-residents, the laws and  
rd to security export control, must be observed.

ly to show the main characteristics and application circuit examples  
l property right or other right owned by our company or any other  
any as to the infringement upon any such right owned by any other  
rmation described in this book.

standard applications or general electronic equipment (such as office  
and household appliances).

ng applications:

biles, traffic control equipment, combustion equipment, life support  
reliability are required, or if the failure or malfunction of the prod-

ck are subject to change without notice for modification and/or im-  
use of the products, therefore, ask for the most up-to-date Product  
atisfy your requirements.

bsolute maximum rating and the guaranteed operating conditions  
(.). Especially, please be careful not to exceed the range of absolute  
er-off and mode-switching. Otherwise, we will not be liable for any

take into the consideration of incidence of break down and failure  
n the systems such as redundant design, arresting the spread of fire  
al injury, fire, social damages, for example, by using the products.

own and characteristics change due to external factors (ESD, EOS,  
mounting or at customer's process. When using products for which  
shelf life and the elapsed time since first opening the packages.

ly or partially, without the prior written permission of Matsushita

## Looking for pricing, stock, or lifecycle information?

Click below to explore more details on WIN SOURCE:

 [View 2SD262300L on WIN SOURCE](#)

 [Panasonic Information](#)

## Optimize Your Supply Chain with WIN SOURCE Solutions

-  Global Sourcing Solution
-  Obsolete Management
-  Cost Control Management
-  Shortage Management
-  Alternative Solution
-  Excess Inventory Management