



**THE DATASHEET OF
MIC4690YM TR**



General Description

The MIC4690 SuperSwitcher™ is an easy-to-use, 500kHz step-down PWM voltage regulator. The MIC4690 achieves over 1A of continuous output current over a wide input voltage range in an 8-lead SO (small outline) package.

The high switching frequency of the MIC4690 allows the smallest surface-mount inductors and capacitors to be used. Internal compensation ensures fast transient response and a minimum amount of external components.

The MIC4690 features a power SO-8 package with a special lead frame that allows over 1A of continuous current. The MIC4690, housed in an SO-8, can replace larger TO-220 and TO-263 packages in many applications.

The MIC4690 allows for a high degree of safety. It has a wide input voltage range of 4V to 34V, allowing for it to be used in applications where input voltage transients may be present. Built-in safety features include over-current protection, frequency foldback protection, and thermal shutdown.

The MIC4690 is available in an 8-lead SO package with a junction temperature range of -40°C to $+125^{\circ}\text{C}$.

Features

- SO-8 package with over 1A output current
- Fixed 500kHz operation
- Wide 4V to 34V input voltage range
- Output voltage adjustable to 1.23V
- All surface mount solution
- Internally compensated with fast transient response
- Up to 85% efficiency
- Overcurrent protection
- Frequency foldback short-circuit protection
- Thermal shutdown

Applications

- Simple 1A step-down (buck) regulator
- Replacement of TO-220 and TO-263 designs
- 12V to 5V/3.3V/2.5V/1.8V/1.5V conversion
- 5V to 2.5V/1.8V/1.5V conversion
- On-card switching regulators
- Hard disk drives
- Cable modems
- Positive-to-negative converters
- Simple battery chargers

Typical Application

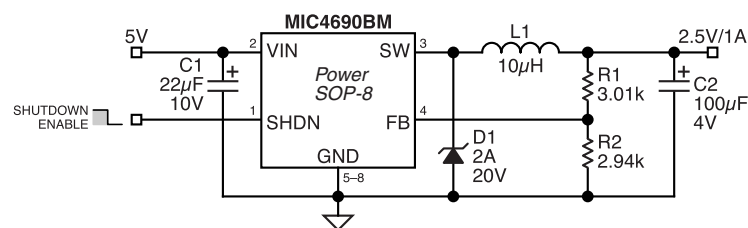

2.5V Adjustable Converter

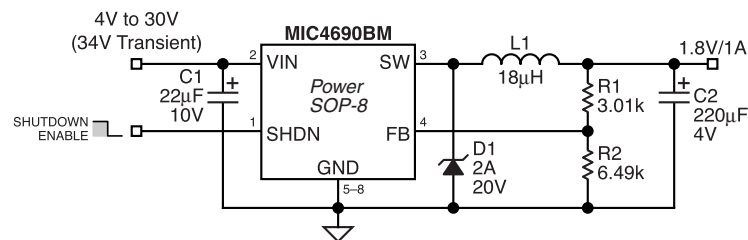

1.8V Adjustable Converter

Ordering Information

Part Number		Voltage	Temperature Range	Package
Standard	Lead-Free			
MIC4690BM	MIC4690YM	Adjustable	-40°C to +125°C	8-lead SOP

Pin Configuration

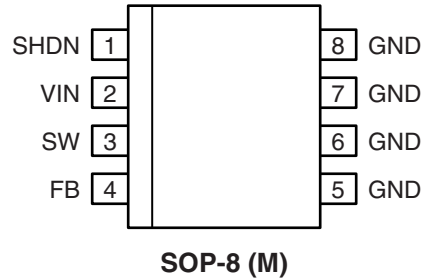

Pin Description

Pin Number	Pin Name	Pin Function
1	SHDN	Shutdown (Input): Logic low enables regulator. Logic high (>1.5V) shuts down regulator.
2	VIN	Supply Voltage (Input): Unregulated +4V to +30V continuous supply voltage, with a maximum +34V transient voltage.
3	SW	Switch (Output): Emitter of NPN output switch. Connect to external storage inductor and Schottky diode.
4	FB	Feedback (Input): Connect to output on fixed output voltage versions, or to 1.23V-tap of voltage-divider network for adjustable version.
5-8	GND	Ground

Absolute Maximum Ratings (Note 1)

Supply Voltage (V_{IN}), Note 3	+34V
Shutdown Voltage (V_{SHDN})	-0.3V to V_{IN}
Steady-State Output Switch Voltage (V_{SW})	-1V to V_{IN}
Feedback Voltage (V_{FB})	+12V
Storage Temperature (T_S)	-65°C to +150°C
ESD Rating	Note 4

Operating Ratings (Note 2)

Supply Voltage (V_{IN})	+4V to +30V
Junction Temperature Range (T_J)	-40°C to +125°C
Package Thermal Resistance	
(θ_{JA}), Note 5	63°C/W
(θ_{JC}),	20°C/W

Electrical Characteristics

$V_{IN} = 12V$, $V_{OUT} = 5V$; $I_{LOAD} = 500mA$; $V_{SHDN} = 0V$, $T_J = 25^\circ C$, unless otherwise noted. **Bold** values indicate $-40^\circ C \leq T_J \leq +125^\circ C$.

Parameter	Condition	Min	Typ	Max	Units
Feedback Voltage	($\pm 1\%$)	1.217	1.230	1.243	V
	($\pm 2\%$)	1.205		1.255	V
	$8V \leq V_{IN} \leq 30V$, $0.1A \leq I_{LOAD} \leq 1A$, $V_{OUT} = 5V$	1.193	1.230	1.267	V
		1.180		1.280	V
Maximum Duty Cycle	$V_{FB} = 1.0V$	90	93		%
Quiescent Current	$V_{FB} = 1.5V$		7	12	mA
Standby Quiescent Current	$V_{SHDN} = 5V$ (regulator off)		30	100	μA
	$V_{SHDN} = 12V$ (regulator off)		1.5		μA
Frequency Foldback	$V_{FB} = 0V$		220	300	KHz
Oscillator Frequency		450	500	550	kHz
Saturation Voltage	$I_{OUT} = 1A$		1.2		V
Output Leakage Current	$V_{IN} = 30V$, $V_{SHDN} = 5V$, $V_{SW} = 0V$		50	500	μA
	$V_{IN} = 30V$, $V_{SHDN} = 5V$, $V_{SW} = -1V$		4	20	mA
Short Circuit Current Limit	$V_{FB} = 0V$, $V_{OUT} = 0V$, See <i>Test Circuit</i>	1.3	2.5	3.0	A
Shutdown Pin Input Logic Level	regulator off	2	1.5		V
	regulator on		1.25	0.8	V
Shutdown Pin Input Current	$V_{SHDN} = 5V$ (regulator off)	-10	-0.7	10	μA
	$V_{SHDN} = 0V$ (regulator on)	-10	-1.5	10	μA
Thermal Shutdown @ T_J			160		$^\circ C$

Note 1. Exceeding the absolute maximum rating may damage the device.

Note 2. With input voltages above the operating rating, the device may be damaged if a short-circuit is applied to the output. The device will otherwise not be damaged up to its absolute maximum voltage rating.

Note 3. Absolute maximum rating is intended for voltage transients only, prolonged dc operation is not recommended.

Note 4. Devices are ESD sensitive. Handling precautions recommended.

Note 5. Measured on 1" square of 1 oz. copper FR4 printed circuit board connected to the device ground leads.

Test Circuit

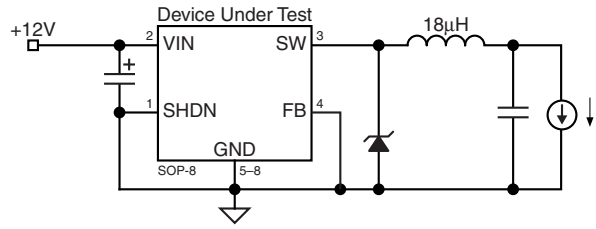

Current Limit Test Circuit

Shutdown Input Behavior

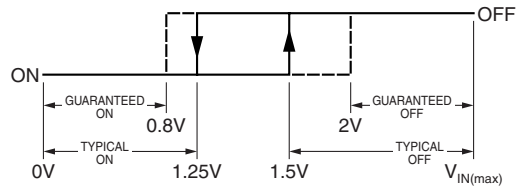

Shutdown Hysteresis

Typical Characteristics

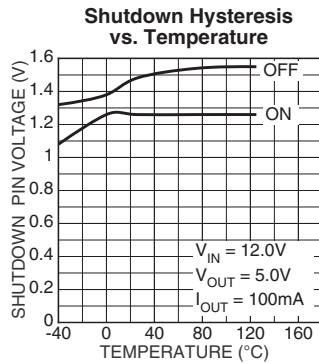
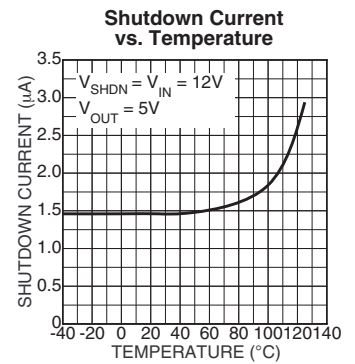
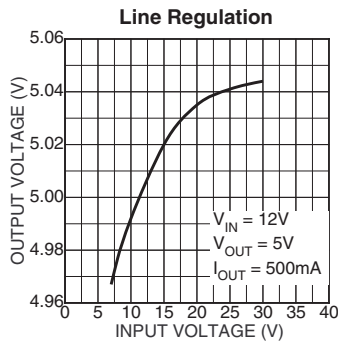
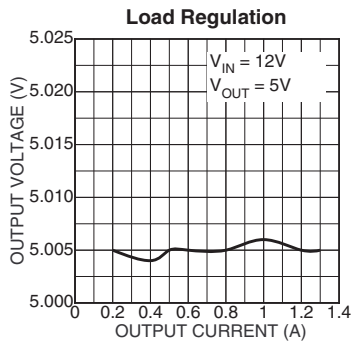
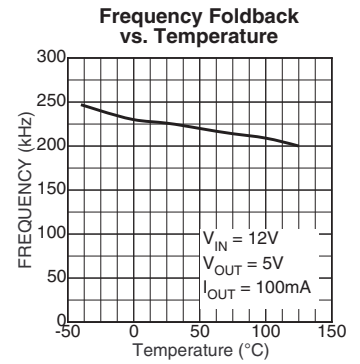
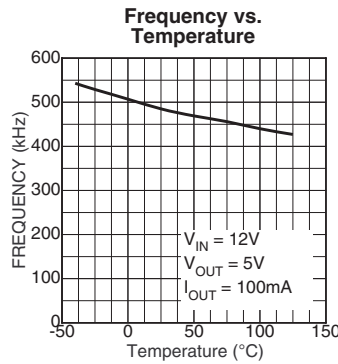
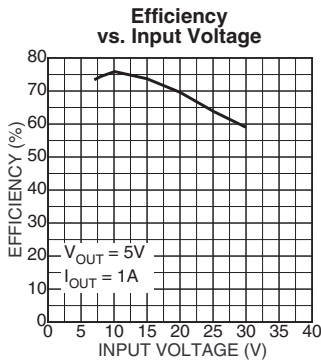
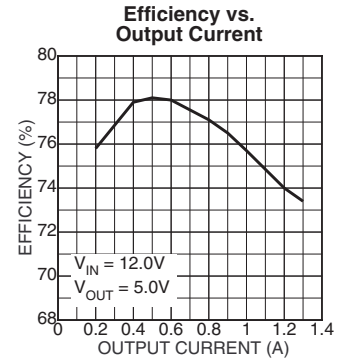
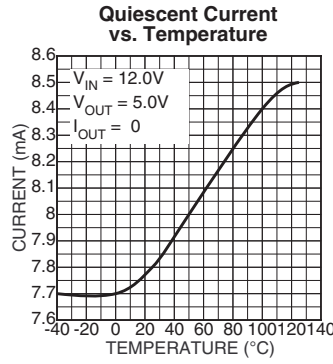
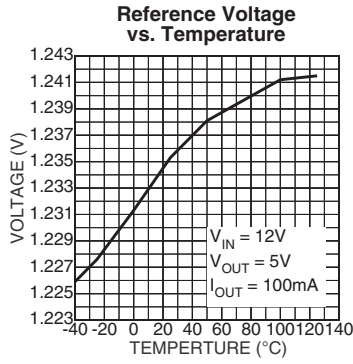

Functional Characteristics

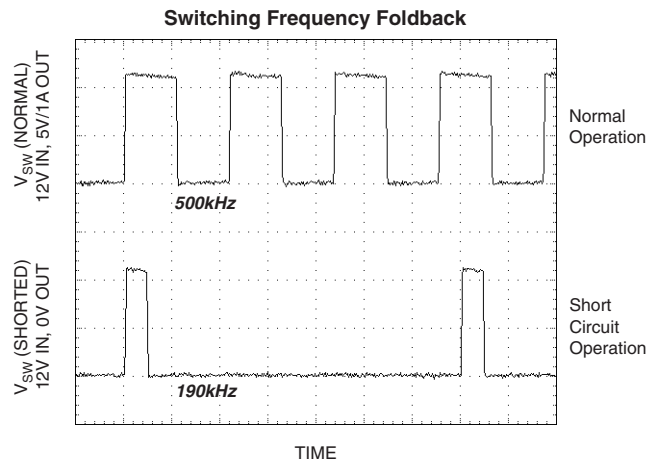
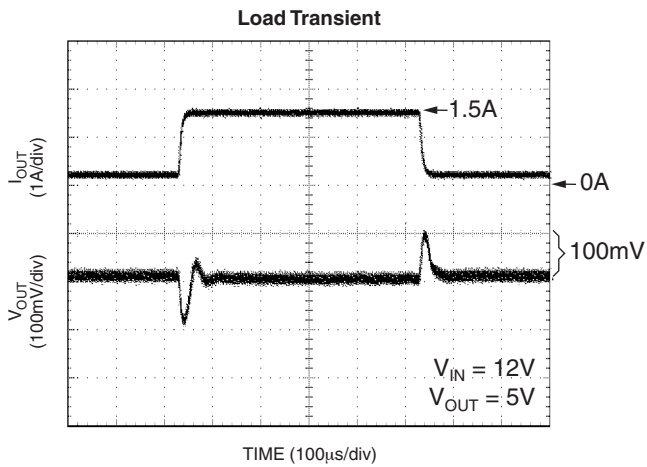

SOA for MIC4690*

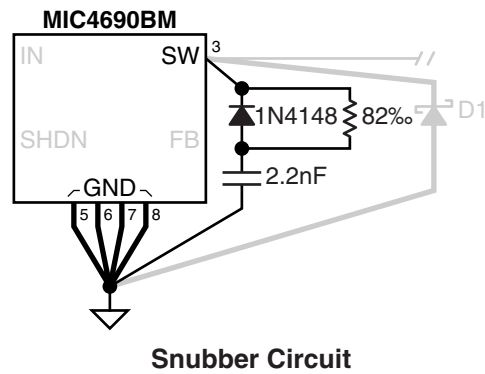
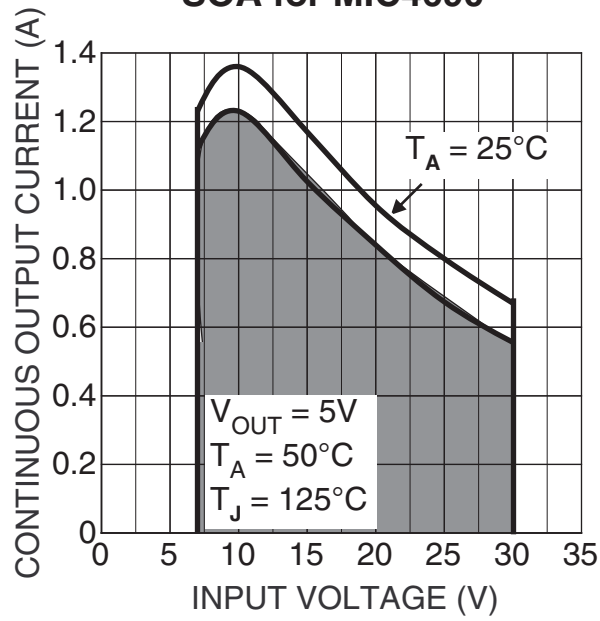

Applications Information

Adjustable Regulators

Adjustable regulators require a 1.23V feedback signal. Recommended voltage-divider resistor values for common output voltages are included in Figure 1b.

For other voltages, the resistor values can be determined using the following formulas:

$$V_{OUT} = V_{REF} \left(\frac{R1}{R2} + 1 \right)$$

$$R1 = R2 \left(\frac{V_{OUT}}{V_{REF}} - 1 \right)$$

$$V_{REF} = 1.23V$$

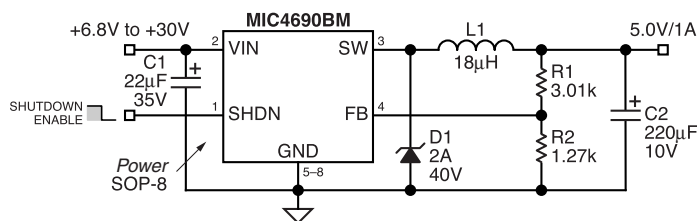

Figure 1a. Adjustable Regulator Circuit

Bill of Material Matrix

V _{OUT}	R1 ⁽¹⁾	R2 ⁽¹⁾	V _{IN}	C _{IN}	D1	L1	C _{OUT}	I _{OUT}
5.0V	3.01k	976Ω	6.8V-30V	22µF, 35V Vishay-Dale 595D226X0035D2T Micro Commercial	2A, 40V Schottky SS24	18µH Sumida CDRH6D38-180ML	220µF, 10V Vishay-Dale 594D227X0010D2T	see SOA
5.0V	3.01k	976Ω	6.8V-14V	47µF, 20V Vishay-Dale 595D476X0020C2T Micro Commercial	2A, 20V Schottky SS22	18µH Sumida CDRH6D38-180ML	100µF, 6.3V Vishay-Dale 595D107X06R3C2T	1.0A
3.3V	3.01k	1.78k	4.9V-14V	47µF, 20V Vishay-Dale 595D476X0020C2T Micro Commercial	2A, 20V Schottky SS22	15µH Sumida CDRH6D38-150ML	120µF, 4.0V Vishay-Dale 595D127X0004C2T	1.0A
2.5V	3.01k	2.94k	4.25V-14V	47µF, 20V Vishay-Dale 595D476X0020C2T Micro Commercial	2A, 20V Schottky SS22	10µH Sumida CDRH6D38-100ML	120µF, 4.0V Vishay-Dale 595D127X0004C2T	1.0A
1.8V	3.01k	6.49k	4.0V-14V	47µF, 20V Vishay-Dale 595D476X0020C2T Micro Commercial	2A, 20V Schottky SS22	10µH Sumida CDRH6D38-100ML	120µF, 4.0V Vishay-Dale 595D127X0004C2T	1.0A

Note 1. All resistors 1%

Figure 1b. Recommended Components for Common Output Voltages

Thermal Considerations

The MIC4690 SuperSwitcher™ features the power-SOP-8. This package has a standard 8-lead small-outline package profile, but with much higher power dissipation than a standard SOP-8. Micrel's MIC4690 SuperSwitcher™ family are the first dc-to-dc converters to take full advantage of this package.

The reason that the power SOP-8 has higher power dissipation (lower thermal resistance) is that pins 5 through 8 and the die-attach paddle are a single piece of metal. The die is attached to the paddle with thermally conductive adhesive. This provides a low thermal resistance path from the junction of the die to the ground pins. This design significantly improves package power dissipation by allowing excellent heat transfer through the ground leads to the printed circuit board.

One limitation of the maximum output current on any MIC4690 design is the junction-to-ambient thermal resistance (θ_{JA}) of the design (package and ground plane).

Examining θ_{JA} in more detail:

$$\theta_{JA} = (\theta_{JC} + \theta_{CA})$$

where:

θ_{JC} = junction-to-case thermal resistance

θ_{CA} = case-to-ambient thermal resistance

θ_{JC} is a relatively constant 20°C/W for a power SOP-8.

θ_{CA} is dependent on layout and is primarily governed by the connection of pins 5 through 8 to the ground plane. The purpose of the ground plane is to function as a heat sink.

θ_{JA} is ideally 63°C/W, but will vary depending on the size of the ground plane to which the power SOP-8 is attached.

Determining Ground-Plane Heat-Sink Area

There are two methods of determining the minimum ground plane area required by the MIC4690.

Quick Method

Make sure that MIC4690 pins 5 through 8 are connected to a ground plane with a minimum area of 6cm². This ground plane should be as close to the MIC4690 as possible. The area may be distributed in any shape around the package or on any pcb layer *as long as there is good thermal contact to pins 5 through 8*. This ground plane area is more than sufficient for most designs.

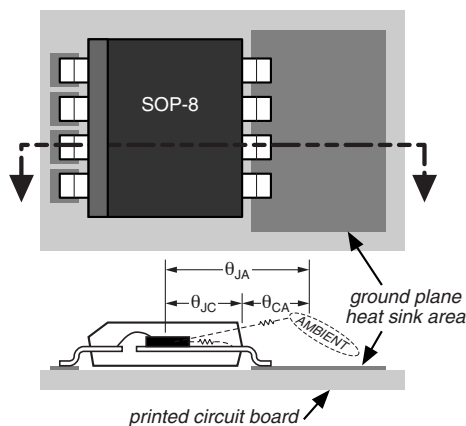

Figure 2. Power SOP-8 Cross Section

When designing with the MIC4690, it is a good practice to connect pins 5 through 8 to the largest ground plane that is practical for the specific design.

Checking the Maximum Junction Temperature:

For this example, with an output power (P_{OUT}) of 5W, (5V output at 1A maximum with $V_{IN} = 12V$) and 50°C maximum ambient temperature, what is the maximum junction temperature?

Referring to the “Typical Characteristics: 5V Output Efficiency” graph, read the efficiency (η) for 1A output current at $V_{IN} = 12V$ or perform your own measurement.

$$\eta = 75\%$$

The efficiency is used to determine how much of the output power (P_{OUT}) is dissipated in the regulator circuit (P_D).

$$P_D = \frac{P_{OUT}}{\eta} - P_{OUT}$$

$$P_D = \frac{5W}{0.75} - 5W$$

$$P_D = 1.67W$$

A worst-case rule of thumb is to assume that 80% of the total output power dissipation is in the MIC4690 ($P_{D(IC)}$) and 20% is in the diode-inductor-capacitor circuit.

$$P_{D(IC)} = 0.8 P_D$$

$$P_{D(IC)} = 0.8 \times 1.67W$$

$$P_{D(IC)} = 1.336W$$

Calculate the worst-case junction temperature:

$$T_J = P_{D(IC)} \theta_{JC} + (T_C - T_A) + T_{A(max)}$$

where:

T_J = MIC4690 junction temperature

$P_{D(IC)}$ = MIC4690 power dissipation

θ_{JC} = junction-to-case thermal resistance.

The θ_{JC} for the MIC4690's power-SOP-8 is approximately 20°C/W.

T_C = “pin” temperature measurement taken at the entry point of pins 6 or 7

T_A = ambient temperature

$T_{A(max)}$ = maximum ambient operating temperature for the specific design.

Calculating the maximum junction temperature given a maximum ambient temperature of 50°C:

$$T_J = 1.336W \times 20^\circ\text{C/W} + (63^\circ\text{C} - 25^\circ\text{C}) + 50^\circ\text{C}$$

$$T_J = 114.72^\circ\text{C}$$

This value is within the allowable maximum operating junction temperature of 125°C as listed in “Operating Ratings.” Typical thermal shutdown is 160°C and is listed in “Electrical Characteristics.”

Layout Considerations

Layout is very important when designing any switching regulator. Rapidly changing currents through the printed circuit board traces and stray inductance can generate voltage transients which can cause problems.

To minimize stray inductance and ground loops, keep trace lengths, indicated by the heavy lines in Figure 5, as short as possible. For example, keep D1 close to pin 3 and pins 5 through 8, keep L1 away from sensitive node FB, and keep C_{IN} close to pin 2 and pins 5 through 8. See “Applications Information: Thermal Considerations” for ground plane layout.

The feedback pin should be kept as far away from the switching elements (usually L1 and D1) as possible.

A circuit with sample layouts are provided. See Figures 6a through 6e. Gerber files are available upon request.

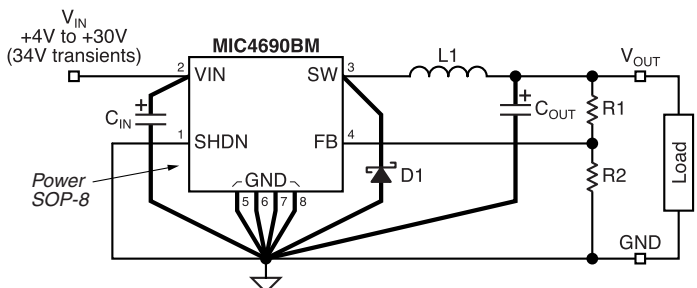

Figure 5. Critical Traces for Layout

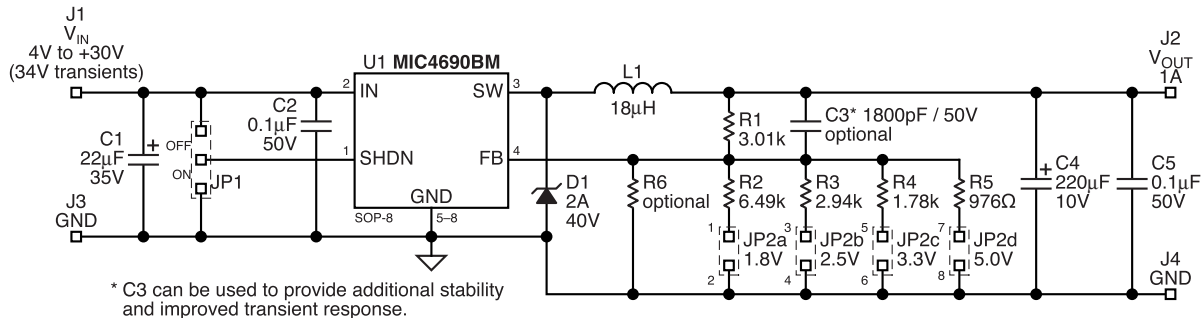

Figure 6a. Evaluation Board Schematic Diagram

Printed Circuit Board Layouts

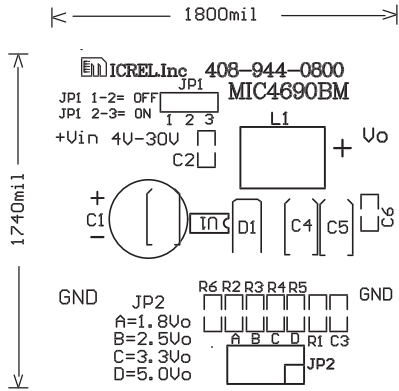

Figure 6b. Top-Side Silk Screen

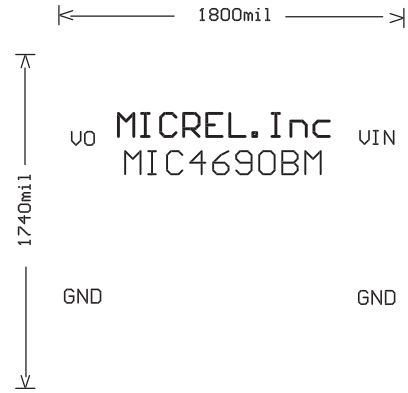

Figure 6d. Bottom-Side Silk Screen

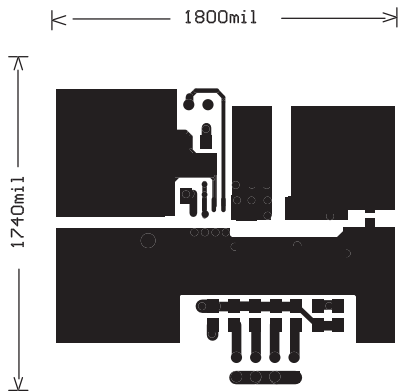

Figure 6c. Top-Side Copper

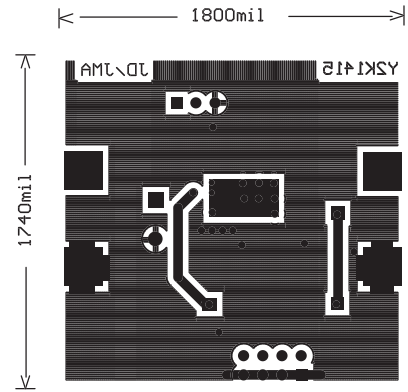

Figure 6e. Bottom-Side Copper

Abbreviated Bill of Material (Critical Components)

Reference	Part Number	Manufacturer	Description	Qty
C1	595D2260035D2T ECE-A1HFS470 TPSD226M035R0300	Vishay Sprague ¹ Panasonic AVX ²	22 μ F, 35V 47 μ F, 50V, 8mm X 11.5mm 22 μ F, 35V	1
C2, C6	VJ0805Y104KXAMB	Vishay Vitramon ²	0.1 μ F 50V	2
C4	594D227X0010D2T	Vishay Sprague ¹	220 μ F, 10V	1
D1	SS24 B240A	Micro Commercial Corp ³ Diode Inc	Schottky 2A, 40A	1
L1	CDRH6D38-180MC	Sumida ⁴	18 μ H, 1.5A I _{SAT}	1
U1	MIC4690BM	Micrel Semiconductor ⁵	1A 200kHz power-SO-8 buck regulator	1

¹ Vishay Dale, Inc., tel: 1 877-847-4291, <http://www.vishay.com>

² Diodes Inc, tel: (805) 446-4800, <http://www.diodes.com>

³ Micro Commercial Corp., tel: (800) 346-3371

⁴ Sumida, tel: (408) 982-9960, <http://www.sumida.com>

⁵ Micrel, tel: (408) 944-0800, <http://www.micrel.com>

Package Information

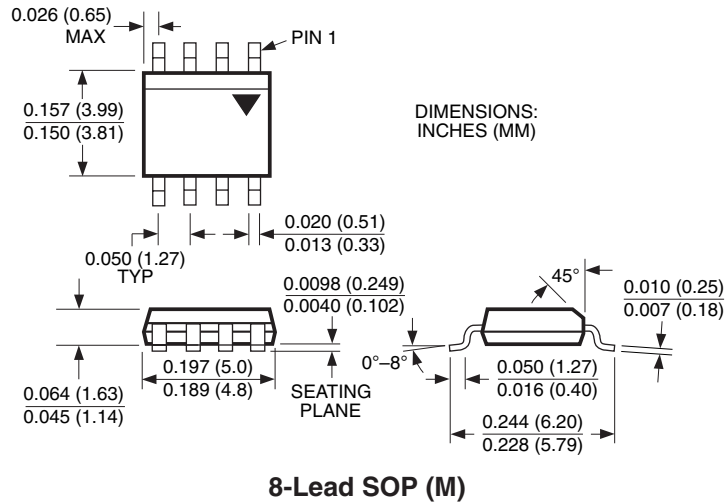

MICREL, INC. 2180 FORTUNE DRIVE SAN JOSE, CA 95131 USA

TEL + 1 (408) 944-0800 FAX + 1 (408) 474-1000 WEB <http://www.micrel.com>

The information furnished by Micrel in this data sheet is believed to be accurate and reliable. However, no responsibility is assumed by Micrel for its use. Micrel reserves the right to change circuitry and specifications at any time without notification to the customer.

Micrel Products are not designed or authorized for use as components in life support appliances, devices or systems where malfunction of a product can reasonably be expected to result in personal injury. Life support devices or systems are devices or systems that (a) are intended for surgical implant into the body or (b) support or sustain life, and whose failure to perform can be reasonably expected to result in a significant injury to the user. A Purchaser's use or sale of Micrel Products for use in life support appliances, devices or systems is at Purchaser's own risk and Purchaser agrees to fully indemnify Micrel for any damages resulting from such use or sale.

© 2005 Micrel, Incorporated.

Looking for pricing, stock, or lifecycle information?

Click below to explore more details on WIN SOURCE:

-  [View MIC4690YM TR on WIN SOURCE](#)
-  [Microchip Technology](#) Information

Optimize Your Supply Chain with WIN SOURCE Solutions

-  Global Sourcing Solution
-  Obsolete Management
-  Cost Control Management
-  Shortage Management
-  Alternative Solution
-  Excess Inventory Management