

200 mA Low Dropout Regulator

Features

- High Output Voltage Accuracy
- Variety of Output Voltages
- Guaranteed 200 mA Output
- Low Quiescent Current
- Low Dropout Voltage
- Extremely Tight Load and Line Regulation
- Very Low Temperature Coefficient
- Current and Thermal Limiting
- Reversed-Battery Protection
- Load-Dump Protection (Fixed Voltage Versions)
- Zero Off-Mode Current
- Logic-Controlled Electronic Enable
- Available in SOIC-8 and SOT-223 Packages

Applications

- Cellular Telephones
- Laptop, Notebook, and Palmtop Computers
- Battery Powered Equipment
- PCMCIA V_{CC} and V_{PP} Regulation/Switching
- Barcode Scanners
- SMPS Post-Regulator and DC/DC Modules
- High-Efficiency Linear Power Supplies

General Description

The MIC5201 is an efficient linear voltage regulator with very low dropout voltage (typically 17 mV at light loads and 200 mV at 100 mA), and very low ground current (1 mA at 100 mA output), offering better than 1% initial accuracy with a logic compatible on-off switching input.

Designed especially for hand-held battery powered devices, the MIC5201 can be switched by a CMOS or TTL compatible enable signal. This enable control may be connected directly to V_{IN} if unneeded. When disabled, power consumption drops nearly to zero. The ground current of the MIC5201 increases only slightly in dropout, further prolonging battery life. Key MIC5201 features include current limiting, overtemperature shutdown, and protection against reversed battery.

The MIC5201 is available in several fixed voltages and accuracy configurations. It features the same pinout as the LT1121 with better performance. Other options are available; contact Microchip for details.

Package Types

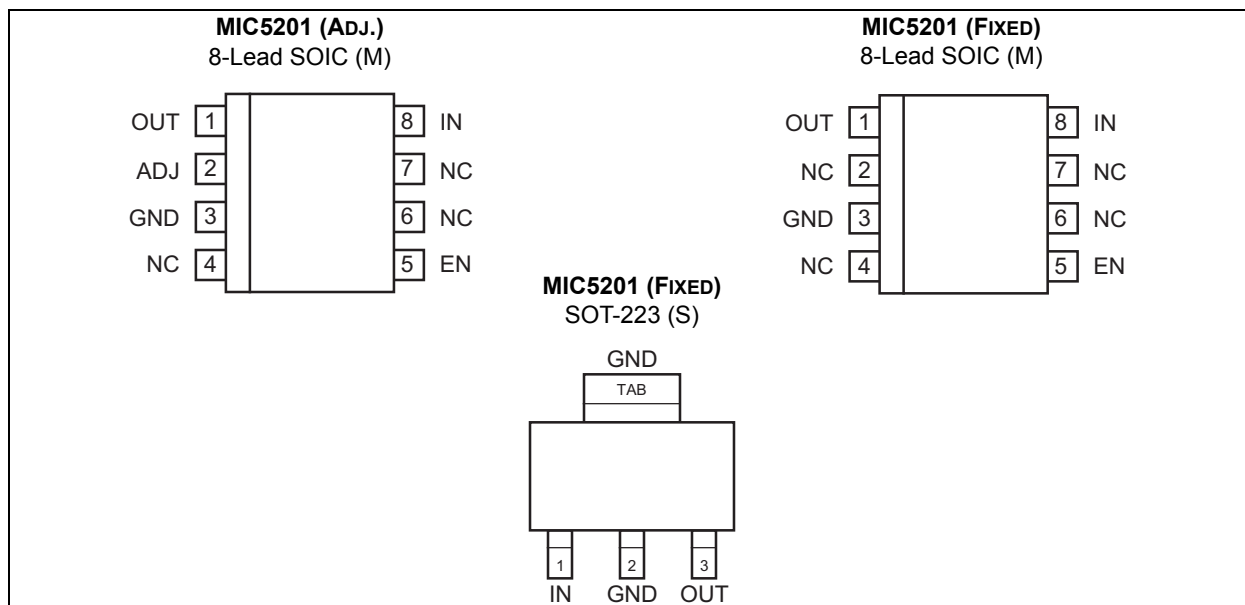

MIC5201

Typical Application Circuit

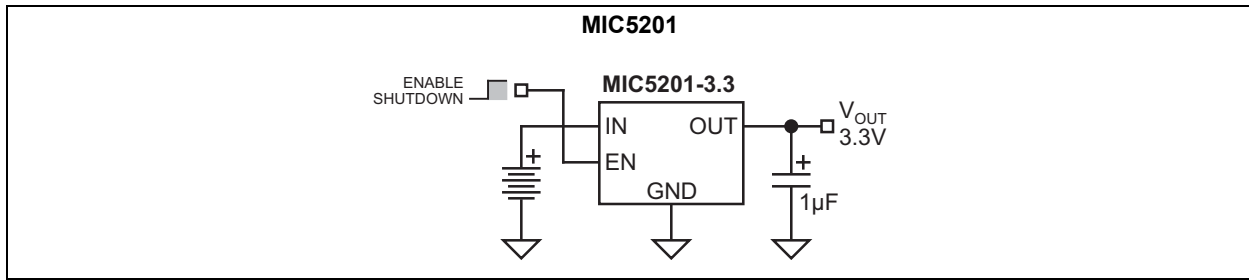

Functional Diagrams

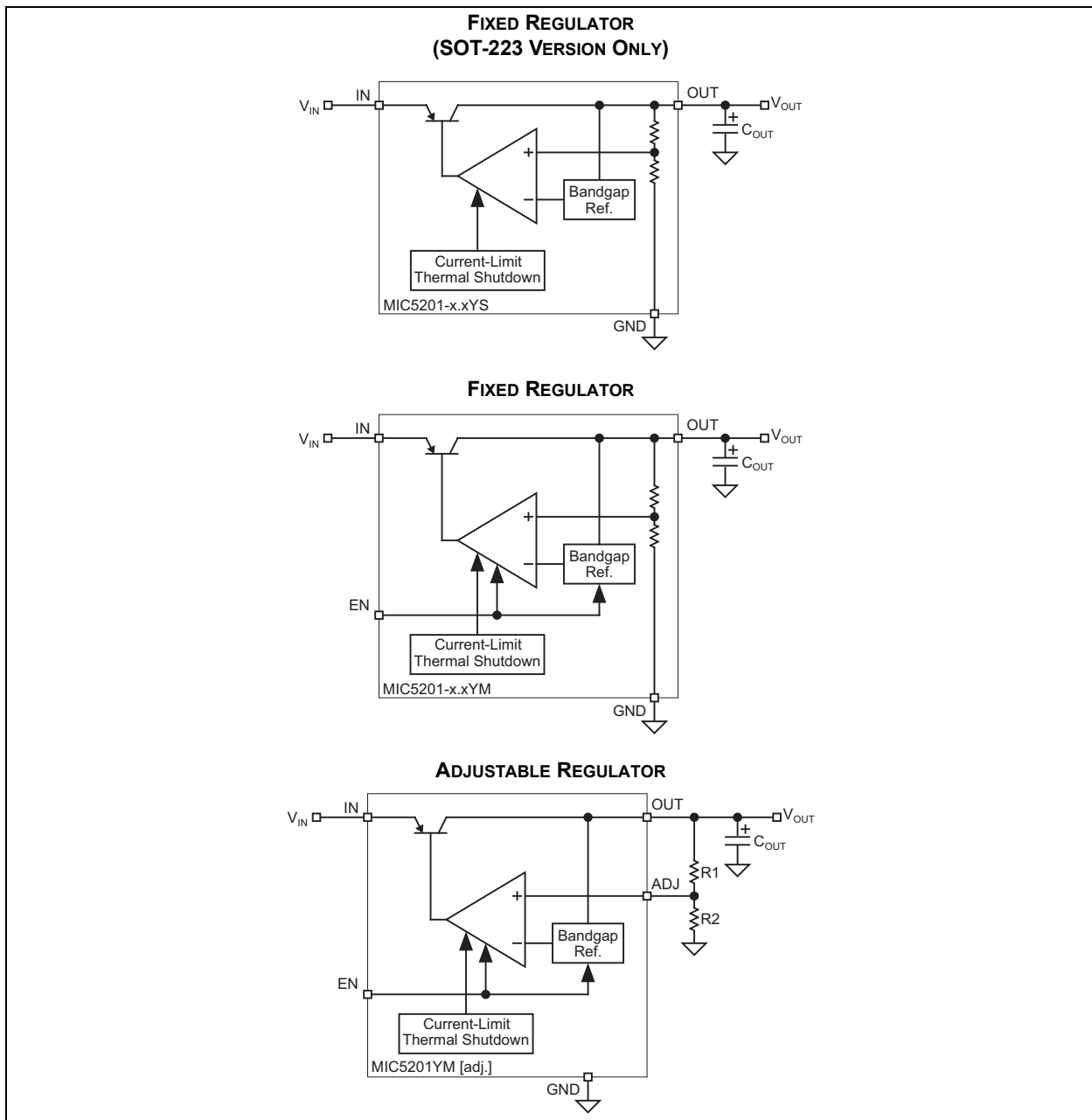

1.0 ELECTRICAL CHARACTERISTICS

Absolute Maximum Ratings †

| | |
|--|--------------------|
| Supply Input Voltage (V_{IN}) Fixed..... | -20V to +60V |
| Supply Input Voltage (V_{IN}) Adjustable..... | -20V to +20V |
| Enable Input Voltage (V_{EN}) Fixed | -20V to +60V |
| Enable Input Voltage (V_{EN}) Adjustable | -20V to +20V |
| Power Dissipation (Note 1) | Internally Limited |

Operating Ratings ‡

| | |
|---|----------------|
| Supply Input Voltage (V_{IN}) Fixed..... | +2.5V to +26V |
| Supply Input Voltage (V_{IN}) Adjustable..... | +2.5V to +16V |
| Enable Input Voltage (V_{EN}) | 0V to V_{IN} |

† **Notice:** Stresses above those listed under “Absolute Maximum Ratings” may cause permanent damage to the device. This is a stress rating only and functional operation of the device at those or any other conditions above those indicated in the operational sections of this specification is not intended. Exposure to maximum rating conditions for extended periods may affect device reliability.

‡ **Notice:** The device is not guaranteed to function outside its operating ratings.

Note 1: The maximum allowable power dissipation is a function of the maximum junction temperature, $T_{J(max)}$, the junction-to-ambient thermal resistance, θ_{JA} , and the ambient temperature, T_A . The maximum allowable power dissipation at any ambient temperature is calculated using: $P_{(max)} = (T_{J(max)} - T_A) \div \theta_{JA}$. Exceeding the maximum allowable power dissipation will result in excessive die temperature, and the regulator will go into thermal shutdown.

MIC5201

TABLE 1-1: ELECTRICAL CHARACTERISTICS (Note 1)

Electrical Characteristics: $V_{IN} = V_{OUT} + 1V$; $I_L = 100 \mu A$; $C_L = 3.3 \mu F$; $V_{EN} \geq 2.0V$; $T_J = +25^\circ C$, **bold** values indicate $-40^\circ C \leq T_J \leq +85^\circ C$; unless noted.

| Parameter | Symbol | Min. | Typ. | Max. | Units | Conditions |
|--|---------------------------|------------|------------|-------------|-----------------|--|
| Output Voltage Accuracy | V_O | -1 | — | 1 | % | Variation from specified V_{OUT} |
| | | -2 | — | 2 | | |
| Output Voltage Temperature Coefficient | $\Delta V_O / \Delta T$ | — | 40 | 150 | ppm/ $^\circ C$ | Note 2 |
| Line Regulation, Fixed | $\Delta V_O / \Delta V_O$ | — | 0.004 | 0.20 | % | $V_{IN} = V_{OUT} + 1V$ to 26V |
| | | — | — | 0.40 | | |
| Line Regulation, Adjustable | $\Delta V_O / \Delta V_O$ | — | 0.004 | 0.20 | % | $V_{IN} = V_{OUT} + 1V$ to 16V |
| | | — | — | 0.40 | | |
| Load Regulation | $\Delta V_O / \Delta V_O$ | — | 0.04 | 0.16 | % | $I_L = 0.1 mA$ to 200 mA, Note 3 |
| | | — | — | 0.30 | | |
| Dropout Voltage, Note 4 | $V_{IN} - V_O$ | — | 17 | — | mV | $I_L = 100 \mu A$ |
| | | — | 130 | — | | $I_L = 20 mA$ |
| | | — | 180 | — | | $I_L = 50 mA$ |
| | | — | 225 | — | | $I_L = 100 mA$ |
| | | — | 270 | 400 | | $I_L = 200 mA$ |
| Quiescent Current | I_{GND} | — | 0.01 | — | μA | $V_{ENABLE} \leq 0.7V$ (shutdown) |
| Ground Pin Current | I_{GND} | — | 130 | — | μA | $I_L = 100 \mu A$ |
| | | — | 270 | 400 | | $I_L = 20 mA$ |
| | | — | 500 | — | | $I_L = 50 mA$ |
| | | — | 1000 | 2000 | | $I_L = 100 mA$ |
| | | — | 3000 | — | | $I_L = 200 mA$ |
| Ripple Rejection | PSRR | — | 75 | — | dB | — |
| Ground Pin Current at Dropout | I_{GDND0} | — | 270 | 330 | μA | $V_{IN} = 0.5V$ less than specified V_{OUT} , $I_L = 100 \mu A$, Note 5 |
| Current Limit | I_{LIMIT} | — | 280 | 500 | mA | $V_{OUT} = 0V$ |
| Thermal Regulation | $\Delta V_O / \Delta P_D$ | — | 0.05 | — | %/W | Note 6 |
| Output Noise | e_n | — | 100 | — | μV | — |
| Enable Input | | | | | | |
| Input Voltage Level | V_{IL} | — | — | 0.7 | V | Logic-low (off) |
| Input Voltage Level | V_{IH} | 2.0 | — | — | V | Logic-high (on) |
| Enable Input Current | I_{IL} | — | 0.01 | 1 | μA | $V_{IL} \leq 0.7V$ |
| Enable Input Current | I_{IH} | — | 15 | 50 | μA | $V_{IH} \leq 2.0V$ |

TABLE 1-1: ELECTRICAL CHARACTERISTICS (Note 1) (CONTINUED)

Electrical Characteristics: $V_{IN} = V_{OUT} + 1V$; $I_L = 100 \mu A$; $C_L = 3.3 \mu F$; $V_{EN} \geq 2.0V$; $T_J = +25^\circ C$, **bold** values indicate $-40^\circ C \leq T_J \leq +85^\circ C$; unless noted.

| Parameter | Symbol | Min. | Typ. | Max. | Units | Conditions |
|--|---------------------------|--------------|-------|--------------|-----------------|------------|
| Reference (MIC5201 Adjustable Version Only) | | | | | | |
| Reference Voltage | V_{REF} | 1.223 | 1.242 | 1.255 | V | — |
| | | 1.217 | — | 1.267 | | |
| Reference Voltage Temperature Coefficient | $\Delta V_{REF}/\Delta T$ | — | 20 | — | ppm/ $^\circ C$ | — |

- Note 1:** Specification for packaged product only. Devices are ESD sensitive. Handling precautions recommended.
- Output voltage temperature coefficient is defined as the worst-case voltage change divided by the total temperature range.
 - Regulation is measured at constant junction temperature using low duty cycle pulse testing. Parts are tested for load regulation in the load range from 0.1 mA to 200 mA. Changes in output voltage due to heating effects are covered by the thermal regulation specification.
 - Dropout Voltage is defined as the input to output differential at which the output voltage drops 2% below its nominal value measured at 1V differential.
 - Ground pin current is the regulator quiescent current plus pass transistor base current. The total current drawn from the supply is the sum of the load current plus the ground pin current.
 - Thermal regulation is defined as the change in output voltage at a time “t” after a change in power dissipation is applied, excluding load or line regulation effects. Specifications are for a 200 mA load pulse at $V_{IN} = 26V$ for fixed and $V_{IN} = 16V$ for adjustable at $t = 10 \text{ ms}$.

MIC5201

TEMPERATURE SPECIFICATIONS (Note 1)

| Parameters | Sym. | Min. | Typ. | Max. | Units | Conditions |
|-----------------------------------|---------------|------|------|------|-------|---|
| Temperature Ranges | | | | | | |
| Storage Temperature Range | T_J | -40 | — | +125 | °C | — |
| Lead Temperature | — | — | — | +260 | °C | Soldering, 5 sec. |
| Package Thermal Resistance | | | | | | |
| Thermal Resistance SOT-223 | θ_{JC} | — | 15 | — | °C/W | See Thermal Considerations Layout for more information. |
| | θ_{JA} | — | 62 | — | | |
| Thermal Resistance 8-Ld SOIC | θ_{JA} | — | 160 | — | °C/W | See Thermal Considerations Layout for more information. |

Note 1: The maximum allowable power dissipation is a function of ambient temperature, the maximum allowable junction temperature and the thermal resistance from junction to air (i.e., T_A , T_J , θ_{JA}). Exceeding the maximum allowable power dissipation will cause the device operating junction temperature to exceed the maximum +125°C rating. Sustained junction temperatures above +125°C can impact the device reliability.

2.0 TYPICAL PERFORMANCE CURVES

Note: The graphs and tables provided following this note are a statistical summary based on a limited number of samples and are provided for informational purposes only. The performance characteristics listed herein are not tested or guaranteed. In some graphs or tables, the data presented may be outside the specified operating range (e.g., outside specified power supply range) and therefore outside the warranted range.



FIGURE 2-1: Dropout Voltage vs. Output Current.



FIGURE 2-4: Ground Current vs. Output Current.



FIGURE 2-2: Dropout Voltage vs. Temperature.



FIGURE 2-5: Ground Current vs. Supply Voltage.



FIGURE 2-3: Dropout Characteristics.



FIGURE 2-6: Output Voltage vs. Output Current.

MIC5201

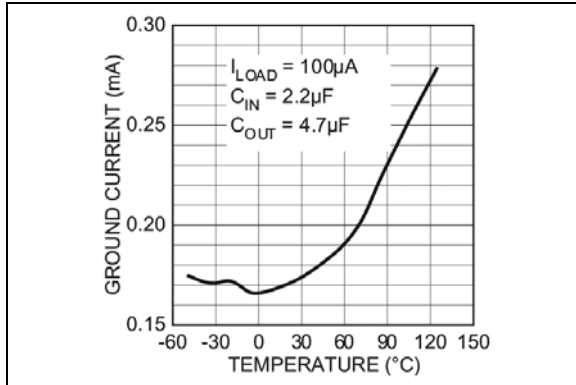

FIGURE 2-7: Ground Current vs. Temperature.



FIGURE 2-10: Output Voltage vs. Temperature (3.3V Version).

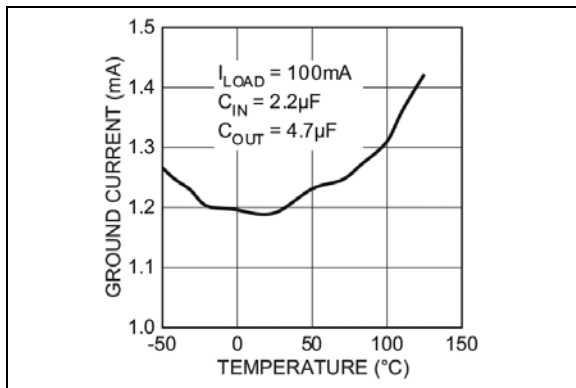

FIGURE 2-8: Ground Current vs. Temperature.



FIGURE 2-11: Output Current vs. Temperature.

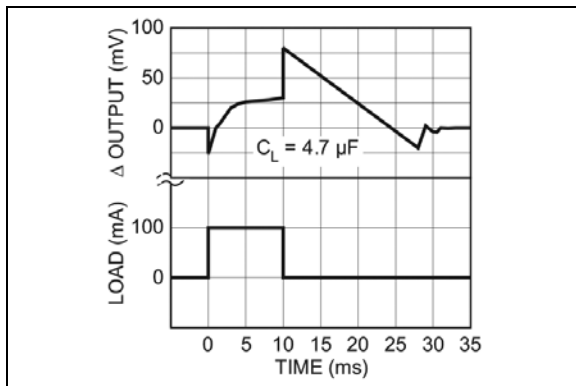

FIGURE 2-9: Thermal Regulation (3.3V Version).



FIGURE 2-12: Minimum Input Voltage vs. Temperature.



FIGURE 2-13: Short-Circuit Current vs. Input Voltage.



FIGURE 2-16: Supply Current vs. Supply Voltage (3.3V Version).

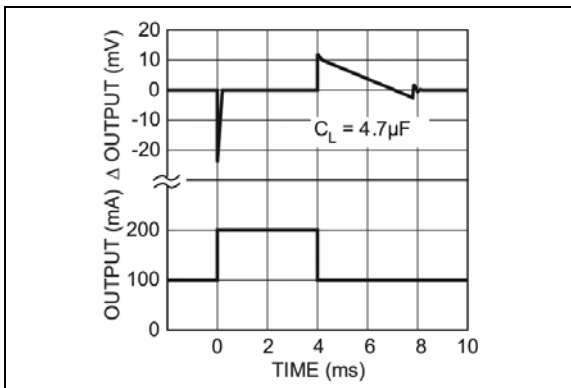

FIGURE 2-14: Load Transient.

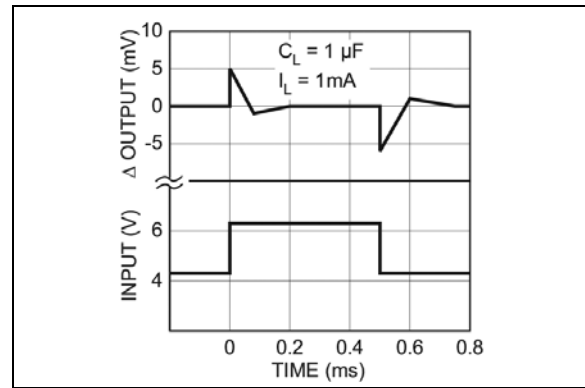

FIGURE 2-17: Line Transient.



FIGURE 2-15: Load Transient.

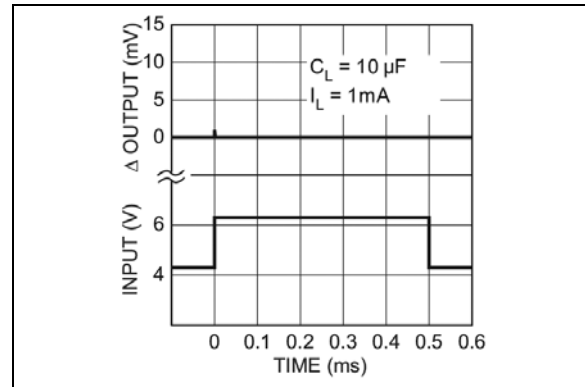

FIGURE 2-18: Line Transient.

MIC5201

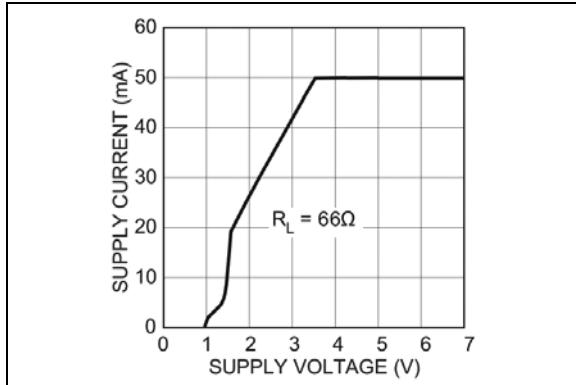

FIGURE 2-19: Supply Current vs. Supply Voltage (3.3V Version).

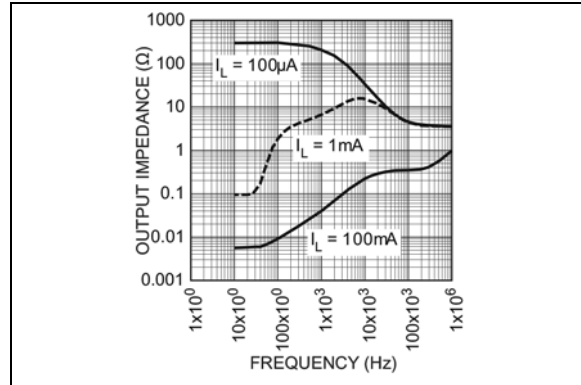

FIGURE 2-22: Output Impedance.

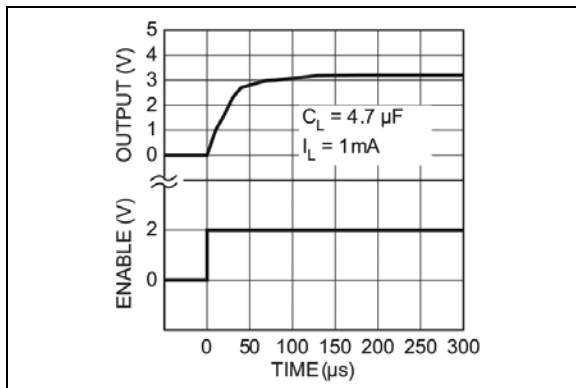

FIGURE 2-20: Enable Transient (3.3V Version).

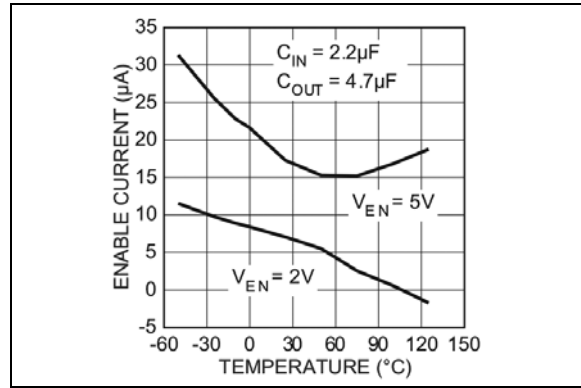

FIGURE 2-23: Enable Current Threshold vs. Temperature.

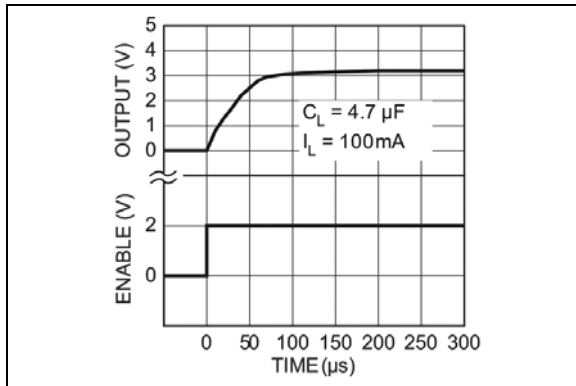

FIGURE 2-21: Enable Transient (3.3V Version).

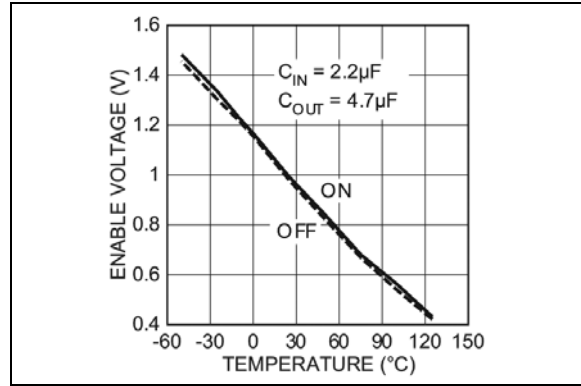

FIGURE 2-24: Enable Voltage Threshold vs. Temperature.



FIGURE 2-25: *Ripple vs. Frequency.*



FIGURE 2-26: *Ripple vs. Frequency.*

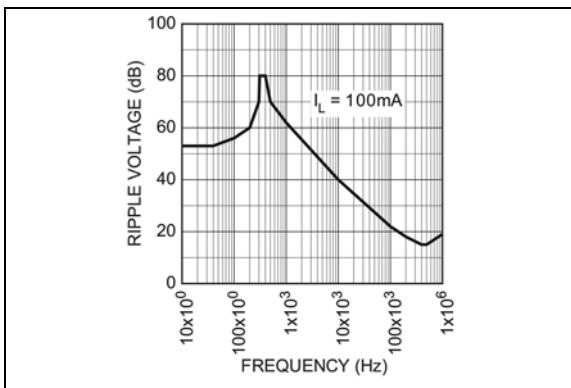

FIGURE 2-27: *Ripple vs. Frequency.*

MIC5201

3.0 PIN DESCRIPTIONS

The descriptions of the pins are listed in [Table 3-1](#).

TABLE 3-1: PIN FUNCTION TABLE

| Pin Number SOT-223 | Pin Number SOIC-8 (Adj.) | Pin Number SOIC-8 (Fixed) | Pin Name | Description |
|-----------------------|-----------------------------|---------------------------------|-----------------|--|
| 3 | 1 | 1 | OUT | Regulated output. |
| — | 2 | — | ADJ | Feedback input. Adjustable version only. |
| — | 4, 6, 7 | 2, 4, 6, 7 | NC | Not internally connected. Connect to ground plane for lowest thermal resistance. |
| 2 | 3 | 3 | GND | Ground. |
| — | 5 | 5 | EN | Enable (input): TTL-compatible input. High = enable. Low or open = off/disable. |
| 1 | 8 | 8 | V _{IN} | Unregulated supply input. |

4.0 APPLICATIONS INFORMATION

Figure 4-1 shows a basic fixed-voltage application with the unused enable input connected to V_{IN} .

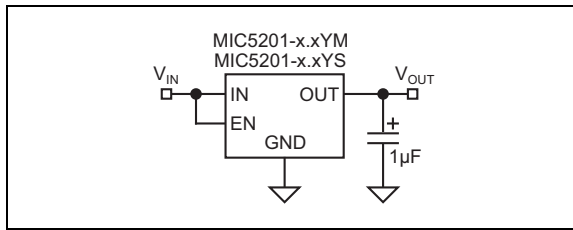

FIGURE 4-1: Fixed Application.

Adjustable regulators require two resistors to set the output voltage. See Figure 4-2.



FIGURE 4-2: Adjustable Application.

Resistor values are not critical because ADJ (adjust) has a high impedance, but for best results use resistors of 470 kΩ or less.

4.1 Output Capacitors

A 1 µF capacitor is recommended between the MIC5201 output and ground to prevent oscillations due to instability. Larger values serve to improve the regulator's transient response. Most types of tantalum or aluminum electrolytics will be adequate; film types will work, but are costly and therefore not recommended. Many aluminum electrolytics have electrolytes that freeze at about -30°C , so solid tantalums are recommended for operation below -25°C . The important parameters of the capacitor are an effective series resistance of about 5Ω or less and a resonant frequency above 500 kHz. The value of this capacitor may be increased without limit.

At lower values of output current, less output capacitance is required for output stability. The capacitor can be reduced to 0.47 µF for current below 10 mA or 0.33 µF for currents below 1 mA.

4.2 Input Capacitors

A 1 µF capacitor should be placed from the MIC5201 input to ground if there is more than 10 inches of wire between the input and the AC filter capacitor or if a battery is used as the input.

4.3 Noise Reduction Capacitors

On adjustable devices, a capacitor from ADJ to GND will decrease high-frequency noise on the output. See Figure 4-3.

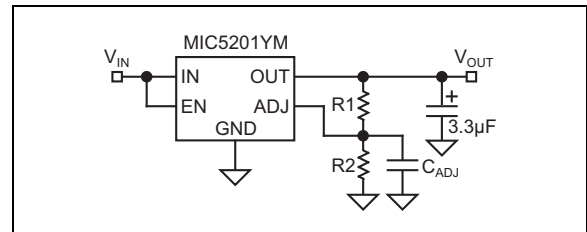

FIGURE 4-3: Decreasing Output Noise.

4.4 Minimum Load

The MIC5201 will remain stable and in regulation with no load unlike many other voltage regulators. This is especially important in CMOS RAM keep-alive applications.

4.5 Dual-Supply Systems

When used in dual supply systems where the regulator load is returned to a negative supply, the output voltage must be diode clamped to ground.

4.6 Thermal Considerations Layout

The MIC5201-x.xYM (8-pin surface mount package) has the following thermal characteristics when mounted on a single layer copper-clad printed circuit board.

TABLE 4-1: THERMAL CHARACTERISTICS

| PCB Dielectric | θ_{JA} |
|----------------|---------------|
| FR4 | 160°C/W |
| Ceramic | 120°C/W |

Multilayer boards having a ground plane, wide traces near the pads, and large supply bus lines provide better thermal conductivity.

The “worst case” value of 160°C/W assumes no ground plane, minimum trace widths, and a FR4 material board.

4.7 Nominal Power Dissipation and Die Temperature

The MIC5201-x.xYM at a $+25^{\circ}\text{C}$ ambient temperature will operate reliably at up to 625 mW power dissipation when mounted in the “worst case” manner described above. At an ambient temperature of $+55^{\circ}\text{C}$, the device may safely dissipate 440 mW. These power levels are equivalent to a die temperature of $+125^{\circ}\text{C}$, the recommended maximum temperature for non-military grade silicon integrated circuits.

MIC5201

For MIC5201-x.xYS (SOT-223 package) heat sink characteristics, please refer to [Application Hint 17, P.C. Board Heat Sinking](#).

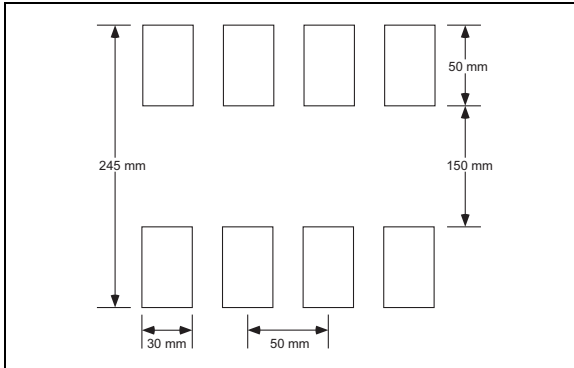
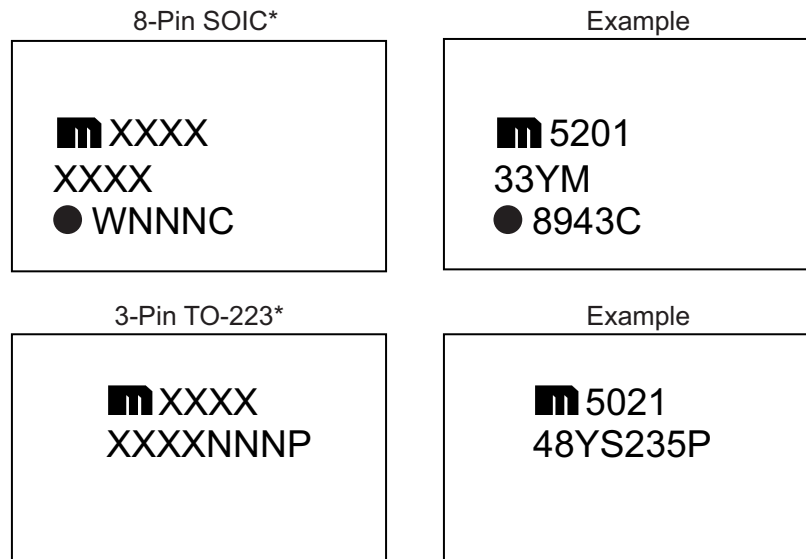

FIGURE 4-4: *Minimum Recommended SOIC-8 PCB Pads Size.*

5.0 PACKAGING INFORMATION

5.1 Package Marking Information



| |
|---|
| <p>Legend:</p> <p>XX...X Product code or customer-specific information</p> <p>Y Year code (last digit of calendar year)</p> <p>YY Year code (last 2 digits of calendar year)</p> <p>WW Week code (week of January 1 is week '01')</p> <p>NNN Alphanumeric traceability code</p> <p>Ⓔ Pb-free JEDEC® designator for Matte Tin (Sn)</p> <p>* This package is Pb-free. The Pb-free JEDEC designator (Ⓔ) can be found on the outer packaging for this package.</p> <p>●, ▲, ▼ Pin one index is identified by a dot, delta up, or delta down (triangle mark).</p> |
| <p>Note: In the event the full Microchip part number cannot be marked on one line, it will be carried over to the next line, thus limiting the number of available characters for customer-specific information. Package may or may not include the corporate logo.</p> <p>Underbar (_) and/or Overbar (¯) symbol may not be to scale.</p> |

MIC5201

8-Lead SOIC Package Outline and Recommended Land Pattern

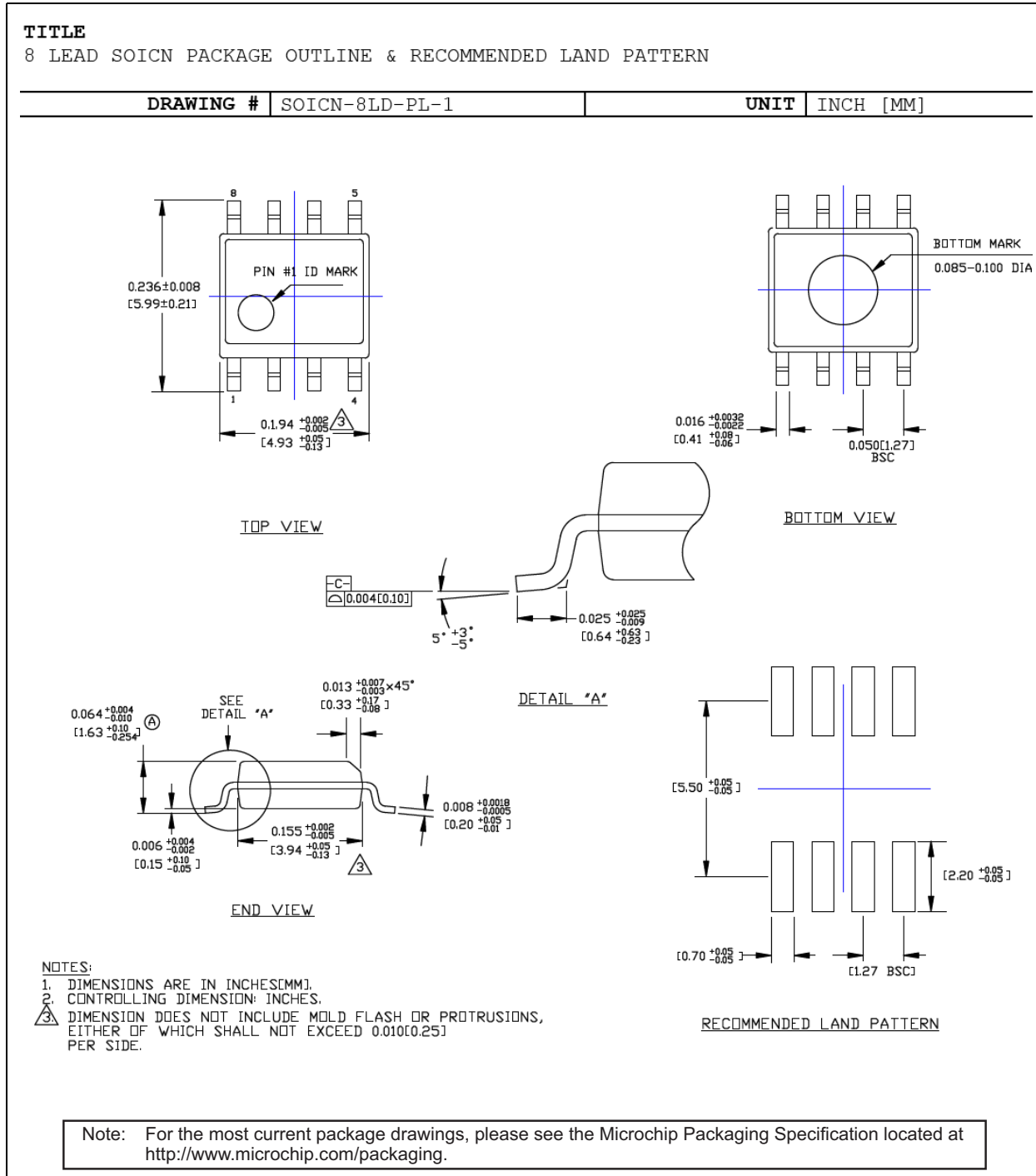

3-Lead TO-223 Package Outline and Recommended Land Pattern

TITLE

3 LEAD SOT223 PACKAGE OUTLINE & RECOMMENDED LAND PATTERN

| DRAWING # | SOT223-3LD-PL-1 | UNIT | MM |
|-----------|-----------------|------|----|
|-----------|-----------------|------|----|

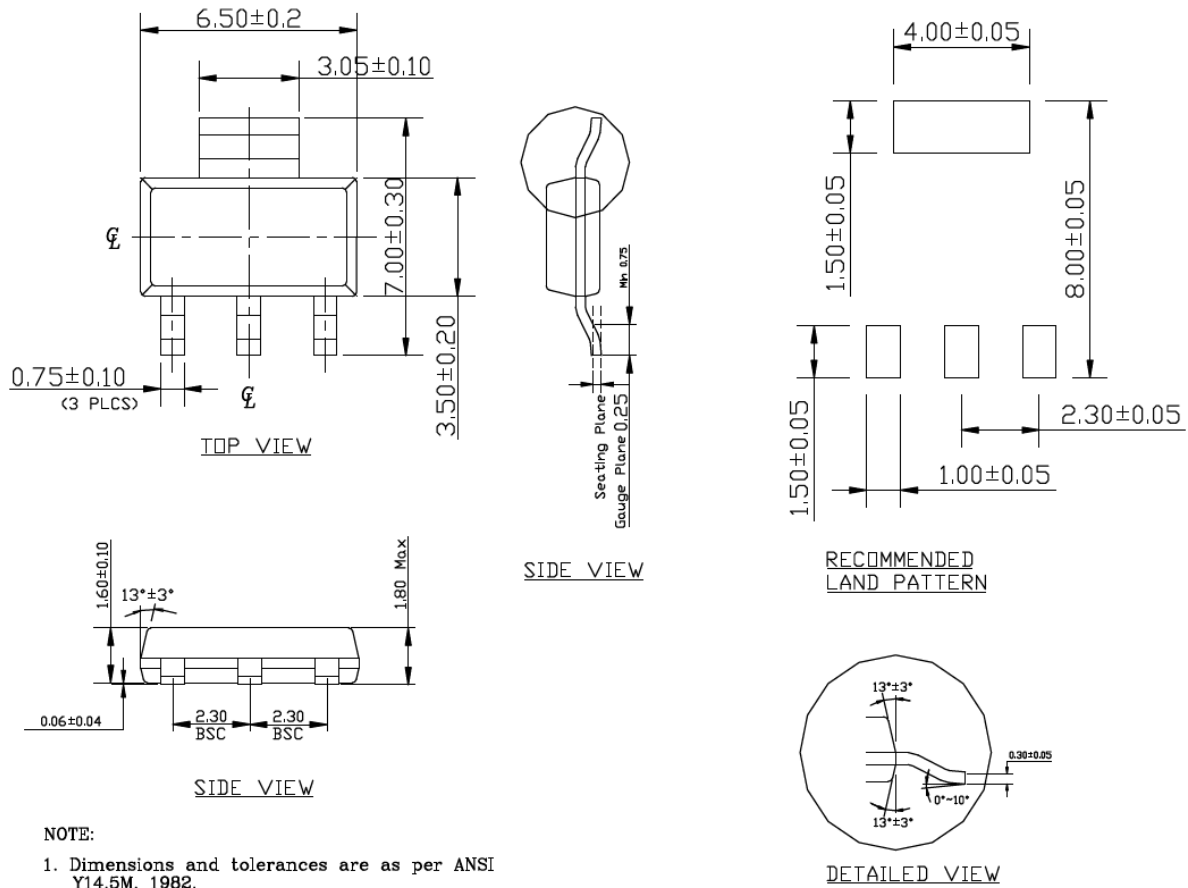

NOTE:

1. Dimensions and tolerances are as per ANSI Y14.5M, 1982.
2. Controlling dimension: Millimeters.
3. Dimensions are exclusive of mold flash and gate burr.
4. All specification comply to Jedec spec TO261 Issue C.

Note: For the most current package drawings, please see the Microchip Packaging Specification located at <http://www.microchip.com/packaging>.

MIC5201

NOTES:

APPENDIX A: REVISION HISTORY

Revision A (February 2017)

- Converted Micrel document MIC5201 to Microchip data sheet DS20005718A.
- Minor text changes throughout.
- Removed all reference to discontinued leaded parts.
- Added θ_{JA} value for SOT-223 package in Temperature Specifications section.

MIC5201

NOTES:

PRODUCT IDENTIFICATION SYSTEM

To order or obtain information, e.g., on pricing or delivery, contact your local Microchip representative or sales office.

| <u>PART NO.</u> | - | <u>XX</u> | <u>X</u> | <u>X</u> | - | <u>XX</u> |
|---|---|-------------------|---|----------|---|------------|
| Device | | Voltage | Junction Temperature Range | Package | | Media Type |
| Device: | | MIC5201: | 200 mA Low Dropout Regulator | | | |
| Voltage: | | (blank) = | Adjustable (M package only) | | | |
| | | 3.0 | = 3.0V | | | |
| | | 3.3 | = 3.3V | | | |
| | | 4.8 | = 4.8V (S package only) | | | |
| | | 5.0 | = 5.0V | | | |
| Junction Temperature Range: | | Y | = -40°C to +125°C | | | |
| Package: | | M | = 8-Lead SOIC | | | |
| | | S | = 3-Lead SOT-223 | | | |
| Media Type: | | TR | = 2,500/Reel | | | |
| | | (blank) | = 95/Tube for M Package | | | |
| | | (blank) | = 78/Tube for S Package | | | |
| Examples: | | | | | | |
| a) | | MIC5201YM: | 200 mA Low Dropout Regulator Adjustable Voltage, 8-Lead SOIC, -40°C to +125°C Junction Temperature Range, 95/Tube | | | |
| b) | | MIC5201-3.0YM-TR: | 200 mA Low Dropout Regulator 3.0V Voltage, 8-Lead SOIC, -40°C to +125°C Junction Temperature Range, 2,500/Reel | | | |
| c) | | MIC5201-3.3YM: | 200 mA Low Dropout Regulator 3.3V Voltage, 8-Lead SOIC, -40°C to +125°C Junction Temperature Range, 95/Tube | | | |
| d) | | MIC5201-5.0YM-TR: | 200 mA Low Dropout Regulator 5.0V Voltage, 8-Lead SOIC, -40°C to +125°C Junction Temperature Range, 2,500/Reel | | | |
| e) | | MIC5201-3.0YS: | 200 mA Low Dropout Regulator 3.0V Voltage, 3-Lead SOT-223, -40°C to +125°C Junction Temperature Range, 78/Tube | | | |
| f) | | MIC5201-3.3YS-TR: | 200 mA Low Dropout Regulator 3.3V Voltage, 3-Lead SOT-223, -40°C to +125°C Junction Temperature Range, 2,500/Reel | | | |
| g) | | MIC5201-4.8YS: | 200 mA Low Dropout Regulator 4.8V Voltage, 3-Lead SOT-223, -40°C to +125°C Junction Temperature Range, 78/Tube | | | |
| h) | | MIC5201-5.0YS-TR: | 200 mA Low Dropout Regulator 5.0V Voltage, 3-Lead SOT-223, -40°C to +125°C Junction Temperature Range, 2,500/Reel | | | |
| Note 1: Tape and Reel identifier only appears in the catalog part number description. This identifier is used for ordering purposes and is not printed on the device package. Check with your Microchip Sales Office for package availability with the Tape and Reel option. | | | | | | |

MIC5201

NOTES:

Note the following details of the code protection feature on Microchip devices:

- Microchip products meet the specification contained in their particular Microchip Data Sheet.
- Microchip believes that its family of products is one of the most secure families of its kind on the market today, when used in the intended manner and under normal conditions.
- There are dishonest and possibly illegal methods used to breach the code protection feature. All of these methods, to our knowledge, require using the Microchip products in a manner outside the operating specifications contained in Microchip's Data Sheets. Most likely, the person doing so is engaged in theft of intellectual property.
- Microchip is willing to work with the customer who is concerned about the integrity of their code.
- Neither Microchip nor any other semiconductor manufacturer can guarantee the security of their code. Code protection does not mean that we are guaranteeing the product as “unbreakable.”

Code protection is constantly evolving. We at Microchip are committed to continuously improving the code protection features of our products. Attempts to break Microchip's code protection feature may be a violation of the Digital Millennium Copyright Act. If such acts allow unauthorized access to your software or other copyrighted work, you may have a right to sue for relief under that Act.

Information contained in this publication regarding device applications and the like is provided only for your convenience and may be superseded by updates. It is your responsibility to ensure that your application meets with your specifications. MICROCHIP MAKES NO REPRESENTATIONS OR WARRANTIES OF ANY KIND WHETHER EXPRESS OR IMPLIED, WRITTEN OR ORAL, STATUTORY OR OTHERWISE, RELATED TO THE INFORMATION, INCLUDING BUT NOT LIMITED TO ITS CONDITION, QUALITY, PERFORMANCE, MERCHANTABILITY OR FITNESS FOR PURPOSE. Microchip disclaims all liability arising from this information and its use. Use of Microchip devices in life support and/or safety applications is entirely at the buyer's risk, and the buyer agrees to defend, indemnify and hold harmless Microchip from any and all damages, claims, suits, or expenses resulting from such use. No licenses are conveyed, implicitly or otherwise, under any Microchip intellectual property rights unless otherwise stated.

Microchip received ISO/TS-16949:2009 certification for its worldwide headquarters, design and wafer fabrication facilities in Chandler and Tempe, Arizona; Gresham, Oregon and design centers in California and India. The Company's quality system processes and procedures are for its PIC® MCUs and dsPIC® DSCs, KEELoC® code hopping devices, Serial EEPROMs, microperipherals, nonvolatile memory and analog products. In addition, Microchip's quality system for the design and manufacture of development systems is ISO 9001:2000 certified.

**QUALITY MANAGEMENT SYSTEM
CERTIFIED BY DNV
= ISO/TS 16949 =**

Trademarks

The Microchip name and logo, the Microchip logo, AnyRate, AVR, AVR logo, AVR Freaks, BeaconThings, BitCloud, CryptoMemory, CryptoRF, dsPIC, FlashFlex, flexPWR, Heldo, JukeBlox, KEELoC, KEELoC logo, Klear, LANCheck, LINK MD, maXStylus, maXTouch, MediaLB, megaAVR, MOST, MOST logo, MPLAB, OptoLyzer, PIC, picoPower, PICSTART, PIC32 logo, Prochip Designer, QTouch, RightTouch, SAM-BA, SpyNIC, SST, SST Logo, SuperFlash, tinyAVR, UNI/O, and XMEGA are registered trademarks of Microchip Technology Incorporated in the U.S.A. and other countries.

ClockWorks, The Embedded Control Solutions Company, EtherSynch, Hyper Speed Control, HyperLight Load, IntelliMOS, mTouch, Precision Edge, and Quiet-Wire are registered trademarks of Microchip Technology Incorporated in the U.S.A.

Adjacent Key Suppression, AKS, Analog-for-the-Digital Age, Any Capacitor, AnyIn, AnyOut, BodyCom, chipKIT, chipKIT logo, CodeGuard, CryptoAuthentication, CryptoCompanion, CryptoController, dsPICDEM, dsPICDEM.net, Dynamic Average Matching, DAM, ECAN, EtherGREEN, In-Circuit Serial Programming, ICSP, Inter-Chip Connectivity, JitterBlocker, KlearNet, KlearNet logo, Mindi, MiWi, motorBench, MPASM, MPF, MPLAB Certified logo, MPLIB, MPLINK, MultiTRAK, NetDetach, Omniscient Code Generation, PICDEM, PICDEM.net, PICKit, PICTail, PureSilicon, QMatrix, RightTouch logo, REAL ICE, Ripple Blocker, SAM-ICE, Serial Quad I/O, SMART-I.S., SQI, SuperSwitcher, SuperSwitcher II, Total Endurance, TSHARC, USBCheck, VariSense, ViewSpan, WiperLock, Wireless DNA, and ZENA are trademarks of Microchip Technology Incorporated in the U.S.A. and other countries.

SQTP is a service mark of Microchip Technology Incorporated in the U.S.A.

Silicon Storage Technology is a registered trademark of Microchip Technology Inc. in other countries.

GestIC is a registered trademark of Microchip Technology Germany II GmbH & Co. KG, a subsidiary of Microchip Technology Inc., in other countries.

All other trademarks mentioned herein are property of their respective companies.

© 2017, Microchip Technology Incorporated, All Rights Reserved.
ISBN: 978-1-5224-1407-0



Worldwide Sales and Service

AMERICAS

Corporate Office
2355 West Chandler Blvd.
Chandler, AZ 85224-6199
Tel: 480-792-7200
Fax: 480-792-7277
Technical Support:
<http://www.microchip.com/support>
Web Address:
www.microchip.com

Atlanta
Duluth, GA
Tel: 678-957-9614
Fax: 678-957-1455

Austin, TX
Tel: 512-257-3370

Boston
Westborough, MA
Tel: 774-760-0087
Fax: 774-760-0088

Chicago
Itasca, IL
Tel: 630-285-0071
Fax: 630-285-0075

Dallas
Addison, TX
Tel: 972-818-7423
Fax: 972-818-2924

Detroit
Novi, MI
Tel: 248-848-4000

Houston, TX
Tel: 281-894-5983

Indianapolis
Noblesville, IN
Tel: 317-773-8323
Fax: 317-773-5453
Tel: 317-536-2380

Los Angeles
Mission Viejo, CA
Tel: 949-462-9523
Fax: 949-462-9608
Tel: 951-273-7800

Raleigh, NC
Tel: 919-844-7510

New York, NY
Tel: 631-435-6000

San Jose, CA
Tel: 408-735-9110
Tel: 408-436-4270

Canada - Toronto
Tel: 905-695-1980
Fax: 905-695-2078

ASIA/PACIFIC

Asia Pacific Office
Suites 3707-14, 37th Floor
Tower 6, The Gateway
Harbour City, Kowloon

Hong Kong
Tel: 852-2943-5100
Fax: 852-2401-3431

Australia - Sydney
Tel: 61-2-9868-6733
Fax: 61-2-9868-6755

China - Beijing
Tel: 86-10-8569-7000
Fax: 86-10-8528-2104

China - Chengdu
Tel: 86-28-8665-5511
Fax: 86-28-8665-7889

China - Chongqing
Tel: 86-23-8980-9588
Fax: 86-23-8980-9500

China - Dongguan
Tel: 86-769-8702-9880

China - Guangzhou
Tel: 86-20-8755-8029

China - Hangzhou
Tel: 86-571-8792-8115
Fax: 86-571-8792-8116

China - Hong Kong SAR
Tel: 852-2943-5100
Fax: 852-2401-3431

China - Nanjing
Tel: 86-25-8473-2460
Fax: 86-25-8473-2470

China - Qingdao
Tel: 86-532-8502-7355
Fax: 86-532-8502-7205

China - Shanghai
Tel: 86-21-3326-8000
Fax: 86-21-3326-8021

China - Shenyang
Tel: 86-24-2334-2829
Fax: 86-24-2334-2393

China - Shenzhen
Tel: 86-755-8864-2200
Fax: 86-755-8203-1760

China - Wuhan
Tel: 86-27-5980-5300
Fax: 86-27-5980-5118

China - Xian
Tel: 86-29-8833-7252
Fax: 86-29-8833-7256

ASIA/PACIFIC

China - Xiamen
Tel: 86-592-2388138
Fax: 86-592-2388130

China - Zhuhai
Tel: 86-756-3210040
Fax: 86-756-3210049

India - Bangalore
Tel: 91-80-3090-4444
Fax: 91-80-3090-4123

India - New Delhi
Tel: 91-11-4160-8631
Fax: 91-11-4160-8632

India - Pune
Tel: 91-20-3019-1500

Japan - Osaka
Tel: 81-6-6152-7160
Fax: 81-6-6152-9310

Japan - Tokyo
Tel: 81-3-6880-3770
Fax: 81-3-6880-3771

Korea - Daegu
Tel: 82-53-744-4301
Fax: 82-53-744-4302

Korea - Seoul
Tel: 82-2-554-7200
Fax: 82-2-558-5932 or
82-2-558-5934

Malaysia - Kuala Lumpur
Tel: 60-3-6201-9857
Fax: 60-3-6201-9859

Malaysia - Penang
Tel: 60-4-227-8870
Fax: 60-4-227-4068

Philippines - Manila
Tel: 63-2-634-9065
Fax: 63-2-634-9069

Singapore
Tel: 65-6334-8870
Fax: 65-6334-8850

Taiwan - Hsin Chu
Tel: 886-3-5778-366
Fax: 886-3-5770-955

Taiwan - Kaohsiung
Tel: 886-7-213-7830

Taiwan - Taipei
Tel: 886-2-2508-8600
Fax: 886-2-2508-0102

Thailand - Bangkok
Tel: 66-2-694-1351
Fax: 66-2-694-1350

EUROPE

Austria - Wels
Tel: 43-7242-2244-39
Fax: 43-7242-2244-393

Denmark - Copenhagen
Tel: 45-4450-2828
Fax: 45-4485-2829

Finland - Espoo
Tel: 358-9-4520-820

France - Paris
Tel: 33-1-69-53-63-20
Fax: 33-1-69-30-90-79

France - Saint Cloud
Tel: 33-1-30-60-70-00

Germany - Garching
Tel: 49-8931-9700

Germany - Haan
Tel: 49-2129-3766400

Germany - Heilbronn
Tel: 49-7131-67-3636

Germany - Karlsruhe
Tel: 49-721-625370

Germany - Munich
Tel: 49-89-627-144-0
Fax: 49-89-627-144-44

Germany - Rosenheim
Tel: 49-8031-354-560

Israel - Ra'anana
Tel: 972-9-744-7705

Italy - Milan
Tel: 39-0331-742611
Fax: 39-0331-466781

Italy - Padova
Tel: 39-049-7625286

Netherlands - Drunen
Tel: 31-416-690399
Fax: 31-416-690340

Norway - Trondheim
Tel: 47-7289-7561

Poland - Warsaw
Tel: 48-22-3325737

Romania - Bucharest
Tel: 40-21-407-87-50

Spain - Madrid
Tel: 34-91-708-08-90
Fax: 34-91-708-08-91

Sweden - Gothenberg
Tel: 46-31-704-60-40

Sweden - Stockholm
Tel: 46-8-5090-4654

UK - Wokingham
Tel: 44-118-921-5800
Fax: 44-118-921-5820

Looking for pricing, stock, or lifecycle information?

Click below to explore more details on WIN SOURCE:

- ⊖ [View MIC5201-3.0BMM on WIN SOURCE](#)
- ⊖ [Microchip Technology](#) Information

Optimize Your Supply Chain with WIN SOURCE Solutions

- ✓ Global Sourcing Solution
- ✓ Obsolete Management
- ✓ Cost Control Management
- ✓ Shortage Management
- ✓ Alternative Solution
- ✓ Excess Inventory Management