

500 mA Low-Noise LDO Regulator

Features

- Output Voltage Range: 1.8V – 15V
- Meets Intel® Slot 1 and Slot 2 Requirements
- Guaranteed 500 mA Output Over the Full Operating Temperature Range
- Low 500 mV Maximum Dropout Voltage at Full Load
- Extremely Tight Load and Line Regulation
- Thermally Efficient Surface-Mount Package
- Low Temperature Coefficient
- Current and Thermal Limiting
- Reversed-Battery Protection
- No-Load Stability
- 1% Output Accuracy
- Ultra-Low-Noise Capability in SOIC-8 and DDPAK
- Ultra-Small 3 mm × 3 mm DFN Package

Applications

- Pentium II Slot 1 and Slot 2 Support Circuits
- Laptop, Notebook, and Palmtop Computers
- Cellular Telephones
- Consumer and Personal Electronics
- SMPS Post-Regulator and DC/DC Modules
- High-Efficiency Linear Power Supplies

General Description

The MIC5209 is an efficient linear voltage regulator with very low dropout voltage, typically 10 mV at light loads and less than 500 mV at full load, with better than 1% output voltage accuracy.

Designed especially for hand-held, battery-powered devices, the MIC5209 features low ground current to help prolong battery life. An enable/shutdown pin on the SOIC-8 and DDPAK versions can further improve battery life with near-zero shutdown current.

Key features include reversed-battery protection, current limiting, overtemperature shutdown, ultra-low-noise capability (SOIC-8 and DDPAK versions), and is available in thermally efficient packaging. The MIC5209 is available in adjustable or fixed output voltages.

Typical Application Circuits



MIC5209

Package Types



Functional Diagrams



MIC5209

1.0 ELECTRICAL CHARACTERISTICS

Absolute Maximum Ratings †

Supply Voltage (V_{IN}).....	-20V to +20V
Power Dissipation (P_D) (Note 1).....	Internally Limited
ESD Rating (SOT-223).....	2 kV HBM/300V MM
ESD Rating (DFN, SOIC-8).....	5 kV HBM/100V MM

Operating Ratings ‡

Supply Voltage (V_{IN}).....	+2.5V to +16V
Adjustable Output Voltage Range (V_{OUT})	+1.8V to +15V

† **Notice:** Stresses above those listed under “Absolute Maximum Ratings” may cause permanent damage to the device. This is a stress rating only and functional operation of the device at those or any other conditions above those indicated in the operational sections of this specification is not intended. Exposure to maximum rating conditions for extended periods may affect device reliability.

‡ **Notice:** The device is not guaranteed to function outside its operating ratings.

Note 1: The maximum allowable power dissipation at any T_A (ambient temperature) is $P_{D(max)} = (T_{J(max)} - T_A) \times \theta_{JA}$. Exceeding the maximum allowable power dissipation will cause excessive die temperature, and the regulator will go into thermal shutdown. See [Table 4-1](#) and the [Thermal Considerations](#) sub-section in [Applications Information](#) for details.

TABLE 1-1: ELECTRICAL CHARACTERISTICS (Note 1)

Electrical Characteristics: $V_{IN} = V_{OUT} + 1V$; $I_L = 100 \mu A$; $T_J = +25^\circ C$, **bold** values indicate $-40^\circ C \leq T_J \leq +125^\circ C$ except $0^\circ C \leq T_J \leq +125^\circ C$ for $1.8V \leq V_{OUT} \leq 2.5V$, unless noted.

Parameter	Symbol	Min.	Typ.	Max.	Units	Conditions
Output Voltage Accuracy	V_{OUT}	-1	—	1	%	Variation from nominal V_{OUT}
		-2	—	2		
Output Voltage Temperature Coefficient	$\Delta V_{OUT}/\Delta T$	—	40	—	ppm/ $^\circ C$	Note 2
Line Regulation	$\Delta V_{OUT}/V_{OUT}$	—	0.009	0.05	%	$V_{IN} = V_{OUT} + 1V$ to 16V
		—	—	0.10		
Load Regulation	$\Delta V_{OUT}/V_{OUT}$	—	0.05	0.5	%	$I_L = 100 \mu A$ to 500 mA, Note 3
		—	—	0.7		
Dropout Voltage, (Note 4)	$V_{IN} - V_{OUT}$	—	10	60	mV	$I_L = 100 \mu A$
		—	—	80		
		—	115	175		$I_L = 50 mA$
		—	—	250		
		—	165	300		$I_L = 150 mA$
		—	—	400		
		—	350	500		$I_L = 500 mA$
—	—	600				
Ground Pin Current (Note 5, Note 6)	I_{GND}	—	80	130	μA	$V_{EN} \geq 3.0V$, $I_{OUT} = 100 \mu A$
		—	—	170		
		—	350	650		$V_{EN} \geq 3.0V$, $I_{OUT} = 50 mA$
		—	—	900	mA	$V_{EN} \geq 3.0V$, $I_{OUT} = 150 mA$
		—	1.8	2.5		
		—	—	3.0		
		—	8	20		
—	—	25	$V_{EN} \geq 3.0V$, $I_{OUT} = 500 mA$			
Ground Pin Quiescent Current, (Note 6)	I_{GND}	—	0.05	3	μA	$V_{EN} \leq 0.4V$ (shutdown)
		—	0.10	8		$V_{EN} \leq 0.18V$ (shutdown)
Ripple Rejection	PSRR	—	75	—	dB	$f = 120 Hz$
Current Limit	I_{LIMIT}	—	700	900	mA	$V_{OUT} = 0V$
		—	—	1000		
Thermal Regulation	$\Delta V_{OUT}/\Delta P_D$	—	0.05	—	%/W	Note 7
Output Noise, (Note 8)	e_n	—	500	—	nV \sqrt{Hz}	$V_{OUT} = 2.5V$, $I_{OUT} = 50 mA$ $C_{OUT} = 2.2 \mu F$, $C_{BYP} = 0$
		—	300	—		$I_{OUT} = 50 mA$, $C_{OUT} = 2.2 \mu F$ $C_{BYP} = 470 pF$

MIC5209

TABLE 1-1: ELECTRICAL CHARACTERISTICS (Note 1) (CONTINUED)

Electrical Characteristics: $V_{IN} = V_{OUT} + 1V$; $I_L = 100 \mu A$; $T_J = +25^\circ C$, **bold** values indicate $-40^\circ C \leq T_J \leq +125^\circ C$ except $0^\circ C \leq T_J \leq +125^\circ C$ for $1.8V \leq V_{OUT} \leq 2.5V$, unless noted.

Parameter	Symbol	Min.	Typ.	Max.	Units	Conditions
Enable Input						
Enable Input Logic-Low Voltage	V_{ENL}	—	—	0.4	V	$V_{EN} = \text{Logic-low (Regulator shutdown)}$
		—	—	0.18		
		2.0	—	—	V	$V_{EN} = \text{Logic-high (Regulator enabled)}$
Enable Input Current	I_{ENL}	—	0.01	-1	μA	$V_{ENL} \leq 0.4V$
		—	0.01	-2		$V_{ENL} \leq 0.18V$
—	I_{ENH}	—	5	20	μA	$V_{ENH} \geq 2.0V$
		—	—	25		
		—	—	30		
		—	—	50	$V_{ENH} \geq 16V$	

Note 1: Specification for packaged product only.

- 2: Output voltage temperature coefficient is defined as the worst-case voltage change divided by the total temperature range.
- 3: Regulation is measured at constant junction temperature using low duty cycle pulse testing. Parts are tested for load regulation in the load range from 100 μA to 500 mA. Changes in output voltage due to heating effects are covered by the thermal regulation specification.
- 4: Dropout Voltage is defined as the input to output differential at which the output voltage drops 2% below its nominal value measured at 1V differential.
- 5: Ground pin current is the regulator quiescent current plus pass transistor base current. The total current drawn from the supply is the sum of the load current plus the ground pin current.
- 6: V_{EN} is the voltage externally applied to devices with the EN (enable) input pin. SOIC-8 (M) and DDPACK (U) packages only.
- 7: Thermal regulation is the change in output voltage at a time "t" after a change in power dissipation is applied, excluding load or line regulation effects. Specifications are for a 500 mA load pulse at $V_{IN} = 16V$ for $t = 10 \text{ ms}$.
- 8: C_{BYP} is an optional, external bypass capacitor connected to devices with a BYP (bypass) or ADJ (adjust) pin. SOIC-8 (M) and DDPACK (U) packages only.

TEMPERATURE SPECIFICATIONS (Note 1)

Parameters	Sym.	Min.	Typ.	Max.	Units	Conditions
Temperature Ranges						
Storage Temperature Range	T_S	-65	—	+150	°C	—
Lead Temperature	—	—	—	+260	°C	Soldering, 5 sec.
Junction Temperature	T_J	-40	—	+125	°C	$2.5V \leq V_{OUT} \leq 15V$
Junction Temperature	T_J	0	—	+125	°C	$1.8V \leq V_{OUT} < 2.5V$
Package Thermal Resistance						
Thermal Resistance SOT-223	θ_{JA}	—	62	—	°C/W	EIA/JEDEC
	θ_{JC}	—	15	—	°C/W	JES51-751-7, 4 Layer Board
Thermal Resistance SOIC-8	θ_{JA}	—	50	—	°C/W	See Thermal Considerations for more information.
	θ_{JC}	—	25	—	°C/W	
Thermal Resistance DPAK	θ_{JA}	—	31.4	—	°C/W	EIA/JEDEC
	θ_{JC}	—	3	—	°C/W	JES51-751-7, 4 Layer Board
Thermal Resistance 3 mm x 3 mm DFN	θ_{JA}	—	64	—	°C/W	EIA/JEDEC
	θ_{JC}	—	12	—	°C/W	JES51-751-7, 4 Layer Board

Note 1: The maximum allowable power dissipation is a function of ambient temperature, the maximum allowable junction temperature and the thermal resistance from junction to air (i.e., T_A , T_J , θ_{JA}). Exceeding the maximum allowable power dissipation will cause the device operating junction temperature to exceed the maximum +125°C rating. Sustained junction temperatures above +125°C can impact the device reliability.

MIC5209

2.0 TYPICAL PERFORMANCE CURVES

Note: The graphs and tables provided following this note are a statistical summary based on a limited number of samples and are provided for informational purposes only. The performance characteristics listed herein are not tested or guaranteed. In some graphs or tables, the data presented may be outside the specified operating range (e.g., outside specified power supply range) and therefore outside the warranted range.



FIGURE 2-1: Power Supply Rejection Ratio.



FIGURE 2-4: Power Supply Rejection Ratio.



FIGURE 2-2: Power Supply Rejection Ratio.



FIGURE 2-5: Power Supply Rejection Ratio.



FIGURE 2-3: Power Supply Rejection Ratio.



FIGURE 2-6: Power Supply Rejection Ratio.

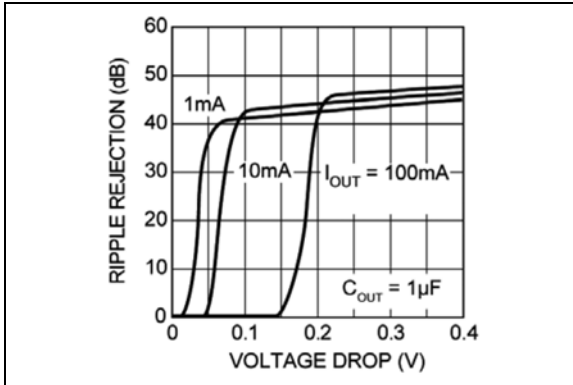

FIGURE 2-7: Power Supply Ripple Rejection vs. Voltage Drop.

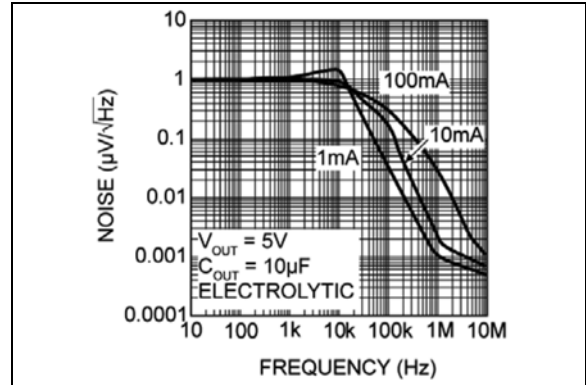

FIGURE 2-10: Noise Performance.

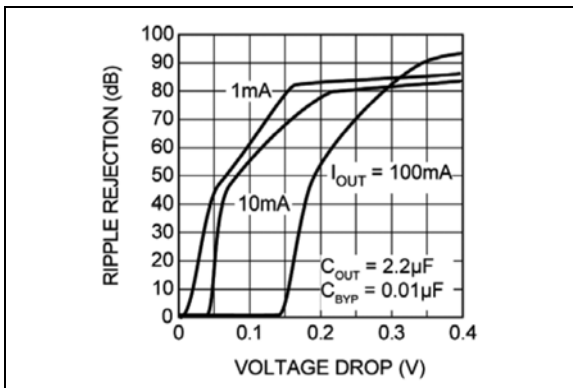

FIGURE 2-8: Power Supply Ripple Rejection vs. Voltage Drop.

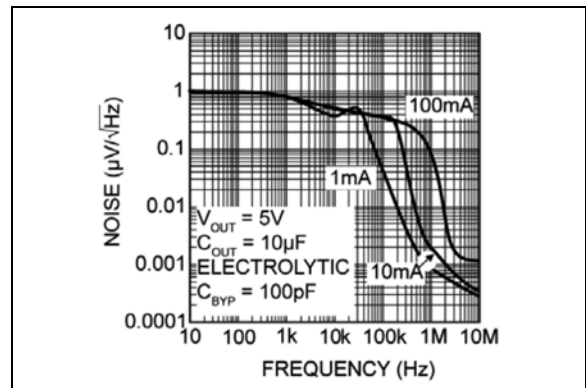

FIGURE 2-11: Noise Performance.

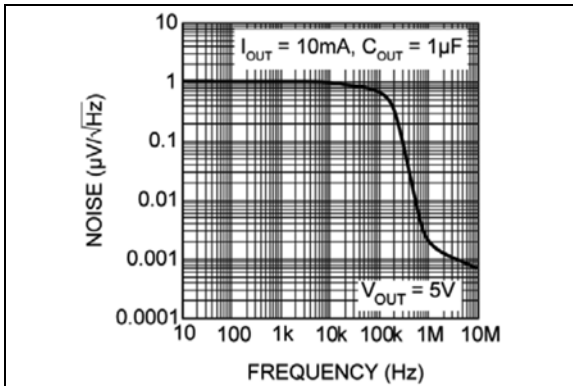

FIGURE 2-9: Noise Performance.

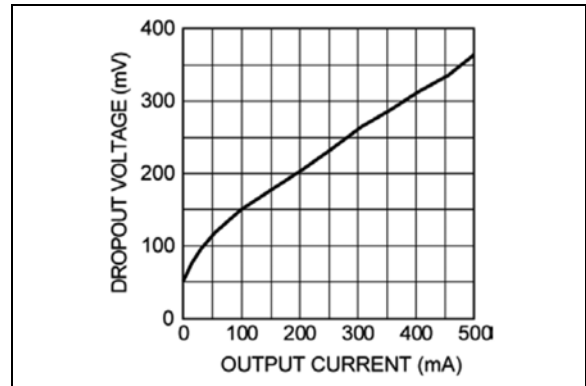

FIGURE 2-12: Dropout Voltage vs. Output Current.

MIC5209



FIGURE 2-13: Ground Current vs. Output Current.



FIGURE 2-14: Ground Current vs. Supply Voltage.



FIGURE 2-15: Ground Current vs. Supply Voltage.

3.0 PIN DESCRIPTIONS

The descriptions of the pins are listed in [Table 3-1](#).

TABLE 3-1: PIN FUNCTION TABLE

Pin Number 8-Pin DFN	Pin Number SOT-223	Pin Number SOIC-8	Pin Number DDPAK	Pin Name	Description
1, 2	1	2	2	IN	Supply Input.
7	2, TAB	5, 6, 7, 8	3, TAB	GND	Ground: SOT-223 Pin 2 and TAB are internally connected. SOIC-8 Pins 5 through 8 are internally connected.
3, 4	3	3	4	OUT	Regulator Output: Pins 3 and 4 must be tied together.
5	—	—	—	NC	Not Connected.
8	—	1	1	EN	Enable (Input): CMOS-compatible control input. Logic-High = Enable; Logic-Low = Shutdown.
—	—	4 (Fixed)	5 (Fixed)	BYP	Reference Bypass: Connect external 470 pF capacitor to GND to reduce output noise. Can be left open. For 1.8V or 2.5V operation, see Application Information.
6	—	4 (Adjustable)	5 (Adjustable)	ADJ	Adjust (Input): Feedback input. Connect to resistive voltage-divider network.
EP	—	—	—	ePad	Exposed Thermal Pad: Connect to GND for best thermal performance.

MIC5209

4.0 APPLICATIONS INFORMATION

4.1 Enable/Shutdown

Enable is not available on devices in the SOT-223 (S) package.

Forcing EN (enable/shutdown) high ($> 2V$) enables the regulator. EN is compatible with CMOS logic. If the enable/shutdown feature is not required, connect EN to IN (supply input).

4.2 Input Capacitor

A $1\ \mu F$ capacitor should be placed from IN to GND if there is more than 10 inches of wire between the input and the AC filter capacitor or if a battery is used as the input.

4.3 Output Capacitor

An output capacitor is required between OUT and GND to prevent oscillation. The minimum size of the output capacitor is dependent upon whether a reference bypass capacitor is used. $1\ \mu F$ minimum is recommended when C_{BYP} is not used (see [Figure 4-1](#)). $2.2\ \mu F$ minimum is recommended when C_{BYP} is $470\ pF$ (see [Figure 4-2](#)). Larger values improve the regulator's transient response.

The output capacitor should have an ESR (equivalent series resistance) of about $1\ \Omega$ and a resonant frequency above $1\ MHz$. Ultra-low-ESR and ceramic capacitors can cause a low amplitude oscillation on the output and/or underdamped transient response. Most tantalum or aluminum electrolytic capacitors are adequate; film types will work, but are more expensive. Since many aluminum electrolytics have electrolytes that freeze at about $-30^\circ C$, solid tantalums are recommended for operation below $-25^\circ C$.

At lower values of output current, less output capacitance is needed for output stability. The capacitor can be reduced to $0.47\ \mu F$ for current below $10\ mA$ or $0.33\ \mu F$ for currents below $1\ mA$.

4.4 No-Load Stability

The MIC5209 will remain stable and in regulation with no load (other than the internal voltage divider) unlike many other voltage regulators. This is especially important in CMOSRAM keep-alive applications.

4.5 Reference Bypass Capacitor

Reference bypass (BYP) is available only on devices in SOIC-8 and DDPACK packages.

BYP is connected to the internal voltage reference. A $470\ pF$ capacitor (C_{BYP}) connected from BYP to GND quiets this reference, providing a significant reduction in output noise (ultra-low-noise performance). Because

C_{BYP} reduces the phase margin, the output capacitor should be increased to at least $2.2\ \mu F$ to maintain stability.

The start-up speed of the MIC5209 is inversely proportional to the size of the reference bypass capacitor. Applications requiring a slow ramp-up of output voltage should consider larger values of C_{BYP} . Likewise, if rapid turn-on is necessary, consider omitting C_{BYP} .

If output noise is not a major concern, omit C_{BYP} and leave BYP open.

4.6 Thermal Considerations

The SOT-223 has a ground tab that allows it to dissipate more power than the SOIC-8 (refer to the [Slot-1 Power Supply](#) sub-section for details). At $+25^\circ C$ ambient, it will operate reliably at $1.6W$ dissipation with "worst-case" mounting (no ground plane, minimum trace widths, and FR4 printed circuit board).

Thermal resistance values for the SOIC-8 represent typical mounting on a $1''$ -square, copper-clad, FR4 circuit board. For greater power dissipation, SOIC-8 versions of the MIC5209 feature a fused internal lead frame and die bonding arrangement that reduces thermal resistance when compared to standard SOIC-8 packages.

TABLE 4-1: MIC5209 THERMAL RESISTANCE

Package	θ_{JA}	θ_{JC}
SOT-223 (S)	$62^\circ C/W$	$15^\circ C/W$
SOIC-8 (M)	$50^\circ C/W$	$25^\circ C/W$
DDPAK (U)	$31.4^\circ C/W$	$3^\circ C/W$
3x3 DFN (ML)	$64^\circ C/W$	$12^\circ C/W$

Multilayer boards with a ground plane, wide traces near the pads, and large supply-bus lines will have better thermal conductivity and will also allow additional power dissipation.

For additional heat sink characteristics, refer to [Application Hint 17](#). For a full discussion of heat sinking and thermal effects on voltage regulators, refer to the "Regulator Thermals" section of the [Designing with Low-Dropout Voltage Regulators](#) handbook.

4.7 Low-Voltage Operation

The MIC5209-1.8 and MIC5209-2.5 require special consideration when used in voltage-sensitive systems. They may momentarily overshoot their nominal output voltages unless appropriate output and bypass capacitor values are chosen.

During regulator power up, the pass transistor is fully saturated for a short time, while the error amplifier and voltage reference are being powered up more slowly from the output (see [Functional Diagrams](#)). Selecting

larger output and bypass capacitors allows additional time for the error amplifier and reference to turn on and prevent overshoot.

To ensure that no overshoot is present when starting up into a light load (100 μ A), use a 4.7 μ F output capacitance and 470 pF bypass capacitance. This slows the turn-on enough to allow the regulator to react and keep the output voltage from exceeding its nominal value. At heavier loads, use a 10 μ F output capacitance and 470 pF bypass capacitance. Lower values of output and bypass capacitance can be used, depending on the sensitivity of the system.

Applications that can withstand some overshoot on the output of the regulator can reduce the output capacitor and/or reduce or eliminate the bypass capacitor. Applications that are not sensitive to overshoot due to power-on reset delays can use normal output and bypass capacitor configurations.

Please note the junction temperature range of the regulator with an output less than 2.5V (fixed and adjustable) is 0°C to +125°C.

4.8 Fixed Regulator Applications

Figure 4-1 shows a basic MIC5209-x.xYM (SOIC-8) fixed-voltage regulator circuit. See Figure 5 for a similar configuration using the more thermally-efficient MIC5209-x.xYS (SOT-223). A 1 μ F minimum output capacitor is required for basic fixed-voltage applications.



FIGURE 4-1: Low-Noise Fixed-Voltage Application.

Figure 4-2 includes the optional 470 pF noise bypass capacitor between BYP and GND to reduce output noise. Note that the minimum value of C_{OUT} must be increased when the bypass capacitor is used.



FIGURE 4-2: Ultra-Low-Noise Fixed-Voltage Application.

4.9 Adjustable Regulator Applications

The MIC5209YM, MIC5209YU, and MIC5209YML can be adjusted to a specific output voltage by using two external resistors (Figure 4-3). The resistors set the output voltage based on the equation:

EQUATION 4-1:

$$V_{OUT} = 1.242V \times \left(1 + \frac{R2}{R1}\right)$$

This equation is correct due to the configuration of the bandgap reference. The bandgap voltage is relative to the output, as seen in the Functional Diagrams. Traditional regulators normally have the reference voltage relative to ground; therefore, their equations are different from the equation for the MIC5209Y.

Although ADJ is a high-impedance input and, for best performance, R2 should not exceed 470 k Ω .



FIGURE 4-3: Low-Noise Adjustable-Voltage Application.

Figure 4-4 includes the optional 470 pF bypass capacitor from ADJ to GND to reduce output noise.



FIGURE 4-4: Ultra-Low-Noise Adjustable Application.

4.10 Slot-1 Power Supply

Intel's Pentium II processors have a requirement for a 2.5V \pm 5% power supply for a clock synthesizer and its associated loads. The current requirement for the 2.5V supply is dependent upon the clock synthesizer used,

MIC5209

the number of clock outputs, and the type of level shifter (from core logic levels to 2.5V levels). Intel estimates a “worst-case” load of 320 mA.

The MIC5209 was designed to provide the 2.5V power requirement for Slot-1 applications. Its guaranteed performance of 2.5V ±3% at 500 mA allows adequate margin for all systems, and the dropout voltage of 500 mV means that it operates from a “worst-case” 3.3V supply where the voltage can be as low as 3.0V.



FIGURE 4-5: Slot-1 Power Supply.

A Slot-1 power supply (Figure 4-5) is easy to implement. Only two capacitors are necessary, and their values are not critical. C_{IN} bypasses the internal circuitry and should be at least 0.1 µF. C_{OUT} provides output filtering, improves transient response, and compensates the internal regulator control loop. Its value should be at least 22 µF. C_{IN} and C_{OUT} can be increased as much as desired.

4.10.1 SLOT-1 POWER SUPPLY POWER DISSIPATION

Powered from a 3.3V supply, the Slot-1 power supply illustrated in Figure 4-5 has a nominal efficiency of 75%. At the maximum anticipated Slot-1 load (320 mA), the nominal power dissipation is only 256 mW.

The SOT-223 package has sufficient thermal characteristics for wide design margins when mounted on a single-layer copper-clad printed circuit board. The power dissipation of the MIC5209 is calculated using the voltage drop across the device output current plus supply voltage ground current.

Considering “worst-case” tolerances, the power dissipation could be as high as:

EQUATION 4-2:

$$(V_{IN(MAX)} - V_{OUT(MAX)}) \times I_{OUT} + V_{IN(MAX)} \times I_{GND}$$

So:

EQUATION 4-3:

$$[(3.6V - 2.375V) \times 320mA] + (3.6V \times 4mA)$$

Resulting in:

EQUATION 4-4:

$$P_D = 407mW$$

Using the maximum junction temperature of +125°C and a θ_{JC} of 15°C/W for the SOT-223, 25°C/W for the SOIC-8, or 3°C/W for the DDPK package, the following worst-case heat-sink thermal resistance (θ_{SA}) requirements are:

EQUATION 4-5:

$$\theta_{JA} = \frac{T_{J(MAX)} - T_A}{P_D}$$

Where: $\theta_{SA} = \theta_{JA} - \theta_{JC}$

Table 4-2 and Figure 4-6 show that the Slot-1 power supply application can be implemented with a minimum footprint layout.

TABLE 4-2: MAXIMUM ALLOWABLE THERMAL RESISTANCE

T_A	+40°C	+50°C	+60°C	+70°C
θ_{JA} Limit	209°C/W	184°C/W	160°C/W	135°C/W
θ_{SA} SOT-223	194°C/W	169°C/W	145°C/W	120°C/W
θ_{SA} SOIC-8	184°C/W	159°C/W	135°C/W	110°C/W
θ_{SA} DDPK	206°C/W	181°C/W	157°C/W	132°C/W

Figure 4-6 shows the necessary copper pad area to obtain specific heatsink thermal resistance (θ_{SA}) values. The θ_{SA} values highlighted in Table 4-2 require much less than 500 mm² of copper and, per Figure 4-6, can be easily accomplished with the minimum footprint.



FIGURE 4-6: PCB Heatsink Thermal Resistance.

MIC5209

5.0 PACKAGING INFORMATION

5.1 Package Marking Information

5-Pin SOT-223*



Example



SOIC-8 (Fixed)*



Example



SOIC-8 (Adj.)*



Example



5-Pin DDPAK (Fixed)*



Example



5-Pin DDPAK (Adj.)*



Example



8-Pin DFN*



Example

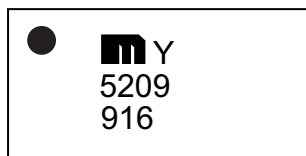

Legend:	XX...X	Product code or customer-specific information
	Y	Year code (last digit of calendar year)
	YY	Year code (last 2 digits of calendar year)
	WW	Week code (week of January 1 is week '01')
	NNN	Alphanumeric traceability code
	(e3)	Pb-free JEDEC® designator for Matte Tin (Sn)
	*	This package is Pb-free. The Pb-free JEDEC designator ((e3)) can be found on the outer packaging for this package.
	•, ▲, ▼	Pin one index is identified by a dot, delta up, or delta down (triangle mark).

Note: In the event the full Microchip part number cannot be marked on one line, it will be carried over to the next line, thus limiting the number of available characters for customer-specific information. Package may or may not include the corporate logo.

Underbar (_) and/or Overbar (¯) symbol may not be to scale.

MIC5209

3-Lead SOT-223 Package Outline and Recommended Land Pattern



5-Lead DPAK Package Outline and Recommended Land Pattern

5-Lead Plastic (ET) [DDPAK]

Note: For the most current package drawings, please see the Microchip Packaging Specification located at <http://www.microchip.com/packaging>



Dimension Limits	Units	INCHES		
		MIN	NOM	MAX
Number of Pins	N	5		
Pitch	e	.067 BSC		
Overall Height	A	.160	–	.190
Standoff §	A1	.000	–	.010
Overall Width	E	.380	–	.420
Exposed Pad Width	E1	.245	–	–
Molded Package Length	D	.330	–	.380
Overall Length	H	.549	–	.625
Exposed Pad Length	D1	.270	–	–
Lead Thickness	c	.014	–	.029
Pad Thickness	C2	.045	–	.065
Lead Width	b	.020	–	.039
Foot Length	L	.068	–	.110
Pad Length	L1	–	–	.067
Foot Angle	φ	0°	–	8°

Notes:

- § Significant Characteristic.
- Dimensions D and E do not include mold flash or protrusions. Mold flash or protrusions shall not exceed .005" per side.
- Dimensioning and tolerancing per ASME Y14.5M.

BSC: Basic Dimension. Theoretically exact value shown without tolerances.

Microchip Technology Drawing C04-012B

MIC5209

5-Lead Plastic (ET) [DDPAK]

Note: For the most current package drawings, please see the Microchip Packaging Specification located at <http://www.microchip.com/packaging>



RECOMMENDED LAND PATTERN

Units		INCHES		
Dimension Limits		MIN	NOM	MAX
Contact Pitch	E	.067 BSC		
Optional Center Pad Width	X2			.423
Optional Center Pad Length	Y2			.327
Contact Pad Spacing	C1		.248	
Contact Pad Width (X5)	X1			.041
Contact Pad Length (X5)	Y1			.159

Notes:

1. Dimensioning and tolerancing per ASME Y14.5M

BSC: Basic Dimension. Theoretically exact value shown without tolerances.

Microchip Technology Drawing No. C04-2012A

8-Lead 3 mm x 3 mm DFN Package Outline and Recommended Land Pattern

TITLE

8 LEAD DFN 3x3mm PACKAGE OUTLINE & RECOMMENDED LAND PATTERN

DRAWING #	DFN33-8LD-PL-1	UNIT	MM
-----------	----------------	------	----



TOP VIEW

NOTE: 1, 2, 3



BOTTOM VIEW

NOTE: 1, 2, 3

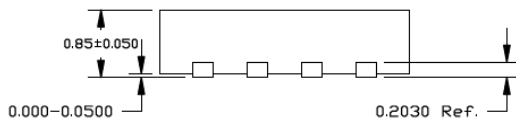

SIDE VIEW

NOTE: 1, 2, 3

NOTE:

1. MAX PACKAGE WARPAGE IS 0.05 MM
2. MAX ALLOWABLE BURR IS 0.076MM IN ALL DIRECTIONS
3. PIN #1 IS ON TOP WILL BE LASER MARKED
4. RED CIRCLE IN LAND PATTERN INDICATE THERMAL VIA. SIZE SHOULD BE 0.30-0.35 MM IN DIAMETER AND SHOULD BE CONNECTED TO GND FOR MAX THERMAL PERFORMANCE
5. GREEN RECTANGLES (SHADED AREA) INDICATE SOLDER STENCIL OPENING ON EXPOSED PAD AREA. SIZE SHOULD BE 0.50x0.90 MM IN SIZE, 0.20 MM SPACING.

Note: For the most current package drawings, please see the Microchip Packaging Specification located at <http://www.microchip.com/packaging>.

POD-Land Pattern drawing #DFN33-8LD-PL-1

RECOMMENDED LAND PATTERN

NOTE: 4, 5



STACKED-UP



EXPOSED METAL TRACE



SOLDER STENCIL OPENING

Note: For the most current package drawings, please see the Microchip Packaging Specification located at <http://www.microchip.com/packaging>.

8-Lead SOIC Package Outline and Recommended Land Pattern

TITLE

8 LEAD SOICN PACKAGE OUTLINE & RECOMMENDED LAND PATTERN

DRAWING #	SOICN-8LD-PL-1	UNIT	INCH [MM]
-----------	----------------	------	-----------

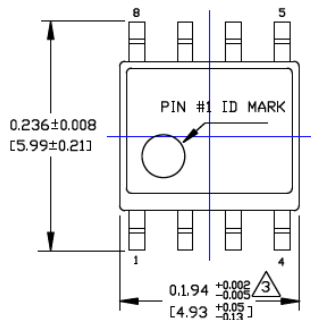

TOP VIEW

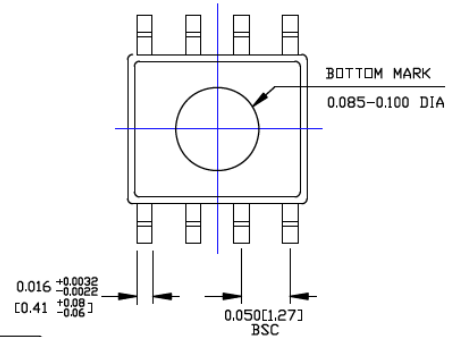

BOTTOM VIEW

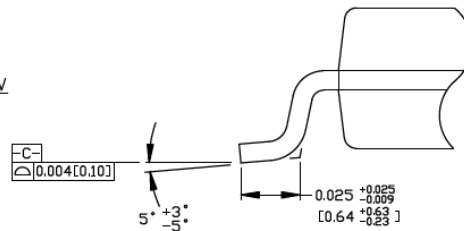

DETAIL "A"

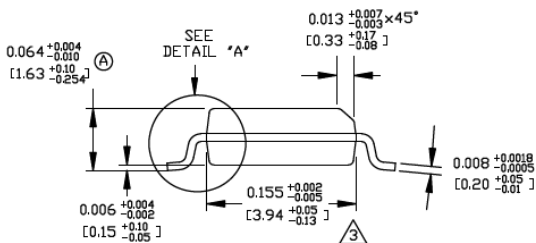

END VIEW

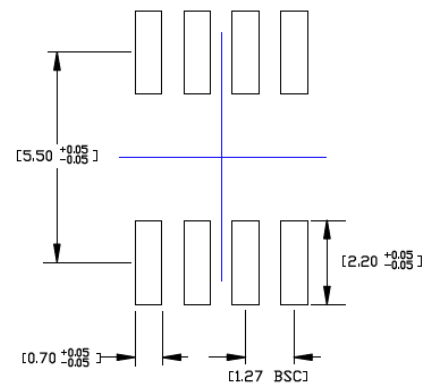

RECOMMENDED LAND PATTERN

NOTES:

1. DIMENSIONS ARE IN INCHES[MM].
2. CONTROLLING DIMENSION: INCHES.
3. DIMENSION DOES NOT INCLUDE MOLD FLASH OR PROTRUSIONS, EITHER OF WHICH SHALL NOT EXCEED 0.010[0.25] PER SIDE.

Note: For the most current package drawings, please see the Microchip Packaging Specification located at <http://www.microchip.com/packaging>.

MIC5209

NOTES:

APPENDIX A: REVISION HISTORY

Revision A (February 2017)

- Converted Micrel document MIC5209 to Microchip data sheet DS20005720A.
- Minor text changes throughout.
- Updated TO-263-5 packaging spec to DDPAK.
- Updated Thermal Resistance values to be current with Microchip packaging.

MIC5209

NOTES:

PRODUCT IDENTIFICATION SYSTEM

To order or obtain information, e.g., on pricing or delivery, contact your local Microchip representative or sales office.

<u>PART NO.</u>	-	<u>XX</u>	<u>X</u>	<u>X</u>	-	<u>XX</u>
Device		Voltage	Temperature	Package		Media Type
Device:		MIC5209:		500 mA Low Noise LDO Regulator		
Voltage:		(blank) = Adjustable				
		1.8 = 1.8V				
		2.5 = 2.5V				
		3.0 = 3.0V				
		3.3 = 3.3V				
		3.6 = 3.6V				
		4.2 = 4.2V				
		5.0 = 5.0V				
Temperature:		Y = -40°C to +125°C				
Package:		M = 8-Lead SOIC				
		ML = 8-Lead DFN				
		S = 3-Lead SOT-223				
		U = 5-Lead DDPAK				
Media Type:		TR = 2,500/Reel (SOIC, SOT-223)				
		TR = 750/Reel (DDPAK)				
		TR = 5,000/Reel (DFN)				
		T5 = 500/Reel (DFN)				
		(blank)= 50/Tube (DDPAK)				
		(blank)= 78/Tube (SOT-223)				
		(blank)= 95/Tube (SOIC)				
Examples:						
a)		MIC5209-1.8YM-TR:		500 mA Low-Noise LDO Regulator, 1.8V Voltage, -40°C to +125°C Temp. Range, 8-Lead SOIC, 2,500/Reel		
b)		MIC5209-1.8YM:		500 mA Low-Noise LDO Regulator, 1.8V Voltage, -40°C to +125°C Temp. Range, 8-Lead SOIC, 95/Tube		
c)		MIC5209-2.5YU-TR:		500 mA Low-Noise LDO Regulator, 2.5V Voltage, -40°C to +125°C Temp. Range, 5-Lead DDPAK, 750/Reel		
d)		MIC5209-2.5YU:		500 mA Low-Noise LDO Regulator, 2.5V Voltage, -40°C to +125°C Temp. Range, 5-Lead DDPAK, 50/Tube		
e)		MIC5209-3.0YS-TR:		500 mA Low-Noise LDO Regulator, 3.0V Voltage, -40°C to +125°C Temp. Range, 3-Lead SOT-223, 2,500/Reel		
f)		MIC5209-3.0YS:		500 mA Low-Noise LDO Regulator, 3.0V Voltage, -40°C to +125°C Temp. Range, 3-Lead SOT-223, 78/Tube		
g)		MIC5209YML-TR:		500 mA Low-Noise LDO Regulator, Adj. Voltage, -40°C to +125°C Temp. Range, 8-Lead DFN, 5,000/Reel		
h)		MIC5209YML-T5:		500 mA Low-Noise LDO Regulator, Adj. Voltage, -40°C to +125°C Temp. Range, 8-Lead DFN, 500/Reel		
Note 1: Tape and Reel identifier only appears in the catalog part number description. This identifier is used for ordering purposes and is not printed on the device package. Check with your Microchip Sales Office for package availability with the Tape and Reel option.						

MIC5209

NOTES:

Note the following details of the code protection feature on Microchip devices:

- Microchip products meet the specification contained in their particular Microchip Data Sheet.
- Microchip believes that its family of products is one of the most secure families of its kind on the market today, when used in the intended manner and under normal conditions.
- There are dishonest and possibly illegal methods used to breach the code protection feature. All of these methods, to our knowledge, require using the Microchip products in a manner outside the operating specifications contained in Microchip's Data Sheets. Most likely, the person doing so is engaged in theft of intellectual property.
- Microchip is willing to work with the customer who is concerned about the integrity of their code.
- Neither Microchip nor any other semiconductor manufacturer can guarantee the security of their code. Code protection does not mean that we are guaranteeing the product as “unbreakable.”

Code protection is constantly evolving. We at Microchip are committed to continuously improving the code protection features of our products. Attempts to break Microchip's code protection feature may be a violation of the Digital Millennium Copyright Act. If such acts allow unauthorized access to your software or other copyrighted work, you may have a right to sue for relief under that Act.

Information contained in this publication regarding device applications and the like is provided only for your convenience and may be superseded by updates. It is your responsibility to ensure that your application meets with your specifications. MICROCHIP MAKES NO REPRESENTATIONS OR WARRANTIES OF ANY KIND WHETHER EXPRESS OR IMPLIED, WRITTEN OR ORAL, STATUTORY OR OTHERWISE, RELATED TO THE INFORMATION, INCLUDING BUT NOT LIMITED TO ITS CONDITION, QUALITY, PERFORMANCE, MERCHANTABILITY OR FITNESS FOR PURPOSE. Microchip disclaims all liability arising from this information and its use. Use of Microchip devices in life support and/or safety applications is entirely at the buyer's risk, and the buyer agrees to defend, indemnify and hold harmless Microchip from any and all damages, claims, suits, or expenses resulting from such use. No licenses are conveyed, implicitly or otherwise, under any Microchip intellectual property rights unless otherwise stated.

Microchip received ISO/TS-16949:2009 certification for its worldwide headquarters, design and wafer fabrication facilities in Chandler and Tempe, Arizona; Gresham, Oregon and design centers in California and India. The Company's quality system processes and procedures are for its PIC® MCUs and dsPIC® DSCs, KEELoC® code hopping devices, Serial EEPROMs, microperipherals, nonvolatile memory and analog products. In addition, Microchip's quality system for the design and manufacture of development systems is ISO 9001:2000 certified.

**QUALITY MANAGEMENT SYSTEM
CERTIFIED BY DNV
= ISO/TS 16949 =**

Trademarks

The Microchip name and logo, the Microchip logo, AnyRate, AVR, AVR logo, AVR Freaks, BeaconThings, BitCloud, CryptoMemory, CryptoRF, dsPIC, FlashFlex, flexPWR, Heldo, JukeBlox, KEELoC, KEELoC logo, Kleer, LANCheck, LINK MD, maXStylus, maXTouch, MediaLB, megaAVR, MOST, MOST logo, MPLAB, OptoLyzer, PIC, picoPower, PICSTART, PIC32 logo, Prochip Designer, QTouch, RightTouch, SAM-BA, SpyNIC, SST, SST Logo, SuperFlash, tinyAVR, UNI/O, and XMEGA are registered trademarks of Microchip Technology Incorporated in the U.S.A. and other countries.

ClockWorks, The Embedded Control Solutions Company, EtherSynch, Hyper Speed Control, HyperLight Load, IntelliMOS, mTouch, Precision Edge, and Quiet-Wire are registered trademarks of Microchip Technology Incorporated in the U.S.A.

Adjacent Key Suppression, AKS, Analog-for-the-Digital Age, Any Capacitor, AnyIn, AnyOut, BodyCom, chipKIT, chipKIT logo, CodeGuard, CryptoAuthentication, CryptoCompanion, CryptoController, dsPICDEM, dsPICDEM.net, Dynamic Average Matching, DAM, ECAN, EtherGREEN, In-Circuit Serial Programming, ICSP, Inter-Chip Connectivity, JitterBlocker, KleerNet, KleerNet logo, Mindi, MiWi, motorBench, MPASM, MPF, MPLAB Certified logo, MPLIB, MPLINK, MultiTRAK, NetDetach, Omniscient Code Generation, PICDEM, PICDEM.net, PICKit, PICTail, PureSilicon, QMatrix, RightTouch logo, REAL ICE, Ripple Blocker, SAM-ICE, Serial Quad I/O, SMART-I.S., SQI, SuperSwitcher, SuperSwitcher II, Total Endurance, TSHARC, USBCheck, VariSense, ViewSpan, WiperLock, Wireless DNA, and ZENA are trademarks of Microchip Technology Incorporated in the U.S.A. and other countries.

SQTP is a service mark of Microchip Technology Incorporated in the U.S.A.

Silicon Storage Technology is a registered trademark of Microchip Technology Inc. in other countries.

GestIC is a registered trademark of Microchip Technology Germany II GmbH & Co. KG, a subsidiary of Microchip Technology Inc., in other countries.

All other trademarks mentioned herein are property of their respective companies.

© 2017, Microchip Technology Incorporated, All Rights Reserved.
ISBN: 978-1-5224-1417-9



MICROCHIP

Worldwide Sales and Service

AMERICAS

Corporate Office
2355 West Chandler Blvd.
Chandler, AZ 85224-6199
Tel: 480-792-7200
Fax: 480-792-7277
Technical Support:
<http://www.microchip.com/support>
Web Address:
www.microchip.com

Atlanta
Duluth, GA
Tel: 678-957-9614
Fax: 678-957-1455

Austin, TX
Tel: 512-257-3370

Boston
Westborough, MA
Tel: 774-760-0087
Fax: 774-760-0088

Chicago
Itasca, IL
Tel: 630-285-0071
Fax: 630-285-0075

Dallas
Addison, TX
Tel: 972-818-7423
Fax: 972-818-2924

Detroit
Novi, MI
Tel: 248-848-4000

Houston, TX
Tel: 281-894-5983

Indianapolis
Noblesville, IN
Tel: 317-773-8323
Fax: 317-773-5453
Tel: 317-536-2380

Los Angeles
Mission Viejo, CA
Tel: 949-462-9523
Fax: 949-462-9608
Tel: 951-273-7800

Raleigh, NC
Tel: 919-844-7510

New York, NY
Tel: 631-435-6000

San Jose, CA
Tel: 408-735-9110
Tel: 408-436-4270

Canada - Toronto
Tel: 905-695-1980
Fax: 905-695-2078

ASIA/PACIFIC

Asia Pacific Office
Suites 3707-14, 37th Floor
Tower 6, The Gateway
Harbour City, Kowloon

Hong Kong
Tel: 852-2943-5100
Fax: 852-2401-3431

Australia - Sydney
Tel: 61-2-9868-6733
Fax: 61-2-9868-6755

China - Beijing
Tel: 86-10-8569-7000
Fax: 86-10-8528-2104

China - Chengdu
Tel: 86-28-8665-5511
Fax: 86-28-8665-7889

China - Chongqing
Tel: 86-23-8980-9588
Fax: 86-23-8980-9500

China - Dongguan
Tel: 86-769-8702-9880

China - Guangzhou
Tel: 86-20-8755-8029

China - Hangzhou
Tel: 86-571-8792-8115
Fax: 86-571-8792-8116

China - Hong Kong SAR
Tel: 852-2943-5100
Fax: 852-2401-3431

China - Nanjing
Tel: 86-25-8473-2460
Fax: 86-25-8473-2470

China - Qingdao
Tel: 86-532-8502-7355
Fax: 86-532-8502-7205

China - Shanghai
Tel: 86-21-3326-8000
Fax: 86-21-3326-8021

China - Shenyang
Tel: 86-24-2334-2829
Fax: 86-24-2334-2393

China - Shenzhen
Tel: 86-755-8864-2200
Fax: 86-755-8203-1760

China - Wuhan
Tel: 86-27-5980-5300
Fax: 86-27-5980-5118

China - Xian
Tel: 86-29-8833-7252
Fax: 86-29-8833-7256

ASIA/PACIFIC

China - Xiamen
Tel: 86-592-2388138
Fax: 86-592-2388130

China - Zhuhai
Tel: 86-756-3210040
Fax: 86-756-3210049

India - Bangalore
Tel: 91-80-3090-4444
Fax: 91-80-3090-4123

India - New Delhi
Tel: 91-11-4160-8631
Fax: 91-11-4160-8632

India - Pune
Tel: 91-20-3019-1500

Japan - Osaka
Tel: 81-6-6152-7160
Fax: 81-6-6152-9310

Japan - Tokyo
Tel: 81-3-6880-3770
Fax: 81-3-6880-3771

Korea - Daegu
Tel: 82-53-744-4301
Fax: 82-53-744-4302

Korea - Seoul
Tel: 82-2-554-7200
Fax: 82-2-558-5932 or
82-2-558-5934

Malaysia - Kuala Lumpur
Tel: 60-3-6201-9857
Fax: 60-3-6201-9859

Malaysia - Penang
Tel: 60-4-227-8870
Fax: 60-4-227-4068

Philippines - Manila
Tel: 63-2-634-9065
Fax: 63-2-634-9069

Singapore
Tel: 65-6334-8870
Fax: 65-6334-8850

Taiwan - Hsin Chu
Tel: 886-3-5778-366
Fax: 886-3-5770-955

Taiwan - Kaohsiung
Tel: 886-7-213-7830

Taiwan - Taipei
Tel: 886-2-2508-8600
Fax: 886-2-2508-0102

Thailand - Bangkok
Tel: 66-2-694-1351
Fax: 66-2-694-1350

EUROPE

Austria - Wels
Tel: 43-7242-2244-39
Fax: 43-7242-2244-393

Denmark - Copenhagen
Tel: 45-4450-2828
Fax: 45-4485-2829

Finland - Espoo
Tel: 358-9-4520-820

France - Paris
Tel: 33-1-69-53-63-20
Fax: 33-1-69-30-90-79

France - Saint Cloud
Tel: 33-1-30-60-70-00

Germany - Garching
Tel: 49-8931-9700

Germany - Haan
Tel: 49-2129-3766400

Germany - Heilbronn
Tel: 49-7131-67-3636

Germany - Karlsruhe
Tel: 49-721-625370

Germany - Munich
Tel: 49-89-627-144-0
Fax: 49-89-627-144-44

Germany - Rosenheim
Tel: 49-8031-354-560

Israel - Ra'anana
Tel: 972-9-744-7705

Italy - Milan
Tel: 39-0331-742611
Fax: 39-0331-466781

Italy - Padova
Tel: 39-049-7625286

Netherlands - Drunen
Tel: 31-416-690399
Fax: 31-416-690340

Norway - Trondheim
Tel: 47-7289-7561

Poland - Warsaw
Tel: 48-22-3325737

Romania - Bucharest
Tel: 40-21-407-87-50

Spain - Madrid
Tel: 34-91-708-08-90
Fax: 34-91-708-08-91

Sweden - Gothenberg
Tel: 46-31-704-60-40

Sweden - Stockholm
Tel: 46-8-5090-4654

UK - Wokingham
Tel: 44-118-921-5800
Fax: 44-118-921-5820

Looking for pricing, stock, or lifecycle information?

Click below to explore more details on WIN SOURCE:

- ⊖ [View MIC5209YMTR on WIN SOURCE](#)
- ⊖ [Microchip Technology Information](#)

Optimize Your Supply Chain with WIN SOURCE Solutions

- ✓ Global Sourcing Solution
- ✓ Obsolete Management
- ✓ Cost Control Management
- ✓ Shortage Management
- ✓ Alternative Solution
- ✓ Excess Inventory Management