

## Dual 150 mA LDO Regulator

### Features

- Mini 8 MSOP Package
- Up to 150 mA per Regulator Output
- Low Quiescent Current
- Low Dropout Voltage
- Wide Selection of Output Voltages
- Tight Load and Line Regulation
- Low Temperature Coefficient
- Current and Thermal Limiting
- Reversed Input Polarity Protection
- Zero Off-Mode Current
- Logic-Controlled Electronic Enable

### Applications

- Cellular Telephones
- Laptop, Notebook, and Palmtop Computers
- Battery-Powered Equipment
- Barcode Scanners
- SMPS Post-Regulator DC/DC Modules
- High-Efficiency Linear Power Supplies

### General Description

The MIC5210 is a dual linear voltage regulator with very low dropout voltage (typically 10 mV at light loads and 140 mV at 100 mA), very low ground current (225  $\mu$ A at 10 mA output), and better than 1% initial accuracy. It also features individual logic-compatible enable/shutdown control inputs.

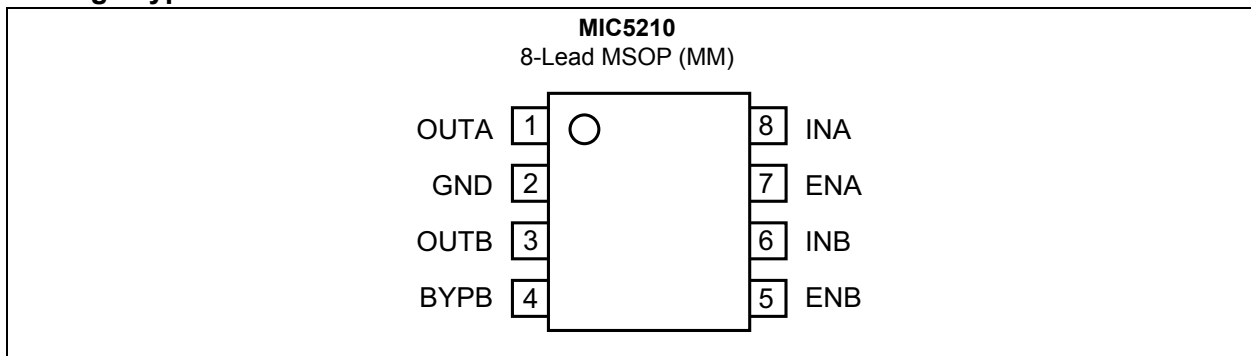
Both regulator outputs can supply up to 150 mA at the same time as long as each regulator's maximum junction temperature is not exceeded.

Key features include a reference bypass pin to improve its already low-noise performance, reversed-battery protection, current limiting, and overtemperature shutdown.

Designed especially for hand-held battery powered devices, the MIC5210 can be switched by a CMOS or TTL compatible logic signal, or the enable pin can be connected to the supply input for 3-terminal operation. When disabled, power consumption drops nearly to zero. Dropout ground current is minimized to prolong battery life.

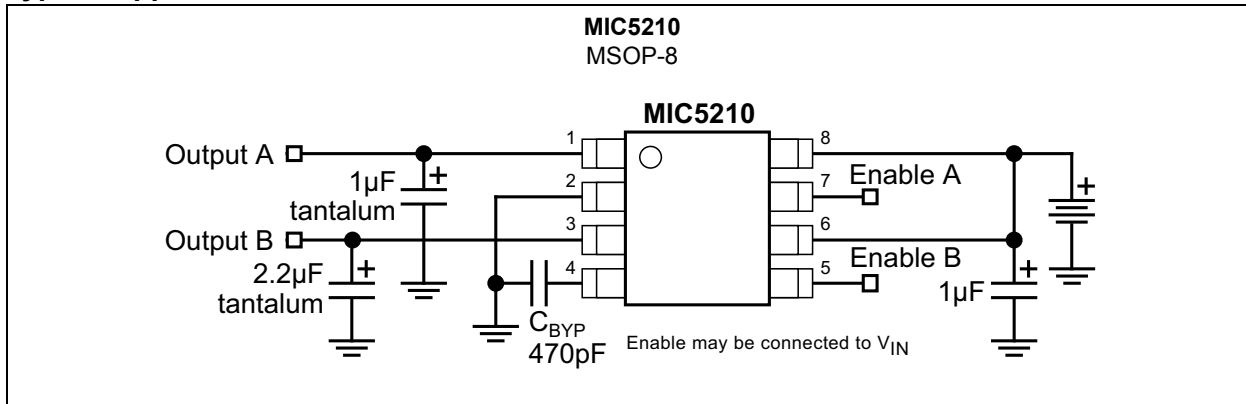
The MIC5210 is available in 2.7V, 2.8V, 3.0V, 3.3V, 3.6V, 4.0V, and 5.0V fixed voltage configurations. Other voltages are available; contact Microchip for details.

### Package Type

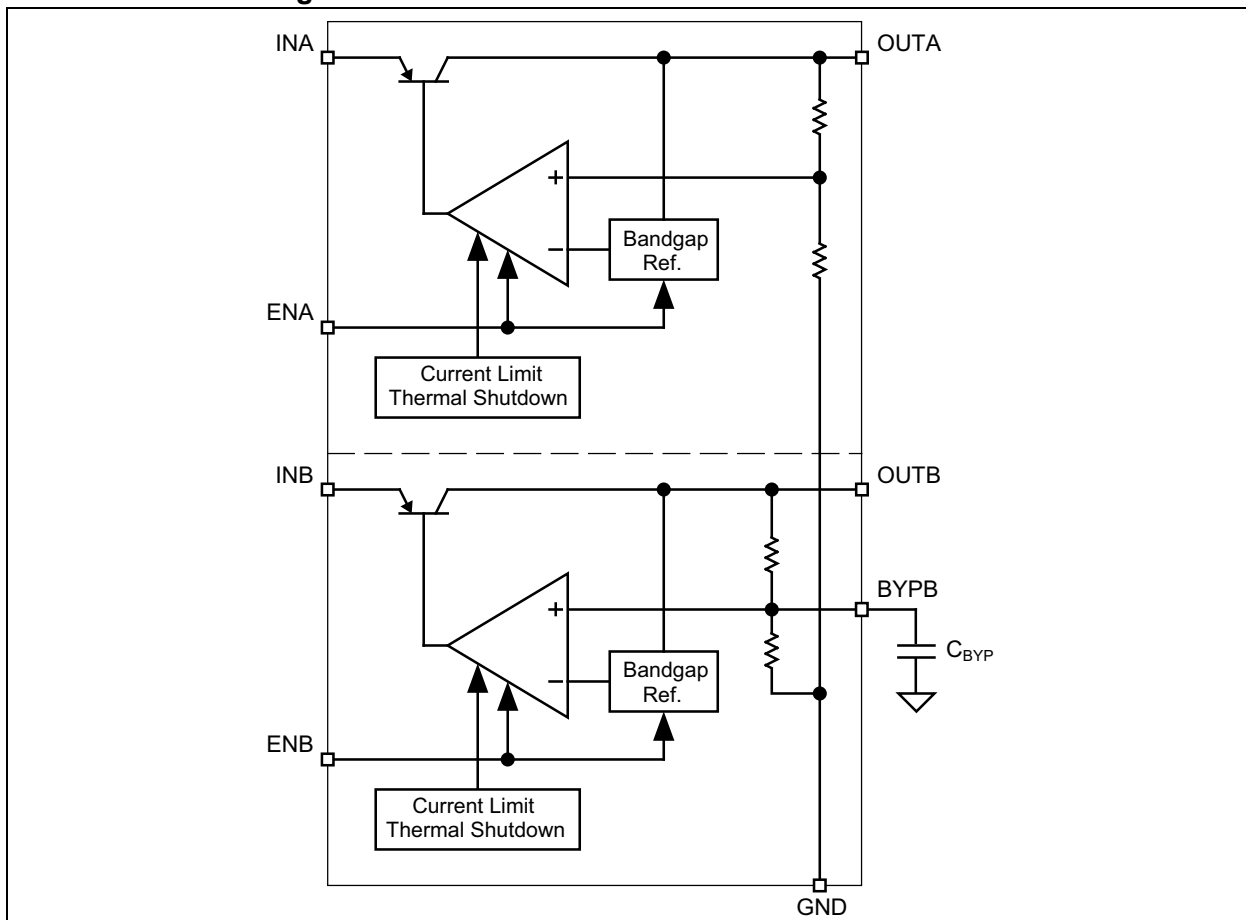


# MIC5210

## Typical Application Circuit



## Functional Block Diagram



## 1.0 ELECTRICAL CHARACTERISTICS

### Absolute Maximum Ratings †

Supply Input Voltage ( $V_{IN}$ )	.....	-20V to +20V
Enable Input Voltage ( $V_{EN}$ )	.....	-20V to +20V
Power Dissipation ( $P_D$ )	.....	Internally Limited

### Operating Ratings ‡

Supply Input Voltage ( $V_{IN}$ )	.....	+2.5V to +16V
Enable Input Voltage ( $V_{EN}$ )	.....	0V to +16V

† **Notice:** Stresses above those listed under “Absolute Maximum Ratings” may cause permanent damage to the device. This is a stress rating only and functional operation of the device at those or any other conditions above those indicated in the operational sections of this specification is not intended. Exposure to maximum rating conditions for extended periods may affect device reliability.

‡ **Notice:** The device is not guaranteed to function outside its operating ratings.

**TABLE 1-1: ELECTRICAL CHARACTERISTICS**

**Electrical Characteristics:**  $V_{IN} = V_{OUT} + 1V$ ;  $I_L = 100 \mu A$ ;  $C_L = 1.0 \mu F$ ;  $V_{EN} \geq 2.0V$ ;  $T_J = +25^\circ C$ , **bold** values indicate  $-40^\circ C < T_J < +125^\circ C$ , unless noted.

Parameter	Symbol	Min.	Typ.	Max.	Units	Conditions
Output Voltage Accuracy	$V_O$	-1	—	1	%	Variation from specified $V_{OUT}$
		<b>-2</b>	—	<b>2</b>		
Output Voltage Temperature Coefficient	$\Delta V_O/\Delta T$	—	<b>40</b>	—	ppm/ $^\circ C$	Note 1
Line Regulation	$\Delta V_O/\Delta V_O$	—	0.004	0.012	%/V	$V_{IN} = V_{OUT} + 1V$ to +16V
		—	—	<b>0.05</b>		
Load Regulation		—	0.02	0.2	%	$I_L = 0.1$ mA to 150 mA (Note 2)
		—	—	<b>0.5</b>		
Dropout Voltage (Note 3)	$V_{IN} - V_O$	—	10	50	mV	$I_L = 100 \mu A$
		—	—	<b>70</b>		
		—	110	150	mV	$I_L = 50$ mA
		—	—	<b>230</b>		
		—	140	250	mV	$I_L = 100$ mA
		—	—	<b>300</b>		
		—	165	275	mV	$I_L = 150$ mA
—	—	<b>350</b>				
Quiescent Current	$I_{GND}$	—	0.01	1	$\mu A$	$V_{EN} \leq 0.4V$ (shutdown)
		—	—	<b>5</b>		$V_{EN} \leq 0.18V$ (shutdown)
Ground Pin Current (Note 4), per regulator	$I_{GND}$	—	80	125	$\mu A$	$V_{EN} \geq 2.0V$ , $I_L = 100 \mu A$
		—	—	<b>150</b>		
		—	350	600	$\mu A$	$I_L = 50$ mA
		—	—	<b>800</b>		
		—	600	1000	$\mu A$	$I_L = 100$ mA
		—	—	<b>1500</b>		
		—	1300	1900	$\mu A$	$I_L = 150$ mA
—	—	<b>2500</b>				
Ripple Rejection	PSRR	—	75	—	dB	Frequency = 100 Hz, $I_L = 100 \mu A$

# MIC5210

**TABLE 1-1: ELECTRICAL CHARACTERISTICS (CONTINUED)**

**Electrical Characteristics:**  $V_{IN} = V_{OUT} + 1V$ ;  $I_L = 100 \mu A$ ;  $C_L = 1.0 \mu F$ ;  $V_{EN} \geq 2.0V$ ;  $T_J = +25^\circ C$ , **bold** values indicate  $-40^\circ C < T_J < +125^\circ C$ , unless noted.

Parameter	Symbol	Min.	Typ.	Max.	Units	Conditions
Current Limit	$I_{LIMIT}$	—	320	500	mA	$V_{OUT} = 0V$
Thermal Regulation	$\Delta V_O / \Delta P_D$	—	0.05	—	%/W	Note 5
Output Noise (Regulator B only)	$e_{no}$	—	260	—	nV/ $\sqrt{Hz}$	$I_L = 50 mA$ , $C_L = 2.2 \mu F$ , 470 pF from BYPB to GND
Enable Input Logic-Low Voltage	$V_{IL}$	—	—	0.4	V	Regulator shutdown
		—	—	<b>0.18</b>		
Enable Input Logic-High Voltage	$V_{IH}$	<b>2.0</b>	—	—	V	Regulator enabled
Enable Input Current	$I_{IL}$	—	0.01	-1	$\mu A$	$V_{IL} \leq 0.4V$
		—	—	<b>-2</b>		$V_{IL} \leq 0.18V$
	$I_{IH}$	—	5	20	$\mu A$	$V_{IH} \geq 2.0V$
		—	—	<b>25</b>		$V_{IH} \geq 2.0V$

- Note 1:** Output voltage temperature coefficient is defined as the worst case voltage change divided by the total temperature range.
- 2:** Regulation is measured at constant junction temperature using low duty cycle pulse testing. Parts are tested for load regulation in the load range from 0.1 mA to 150 mA. Changes in output voltage due to heating effects are covered by the thermal regulation specification.
- 3:** Dropout Voltage is defined as the input to output differential at which the output voltage drops 2% below its nominal value measured at 1V differential.
- 4:** Ground pin current is the regulator quiescent current plus pass transistor base current. The total current drawn from the supply is the sum of the load current plus the ground pin current.
- 5:** Thermal regulation is defined as the change in output voltage at a time “t” after a change in power dissipation is applied, excluding load or line regulation effects. Specifications are for a 150 mA load pulse at  $V_{IN} = 16V$  for  $t = 10 ms$ .

## TEMPERATURE SPECIFICATIONS (Note 1)

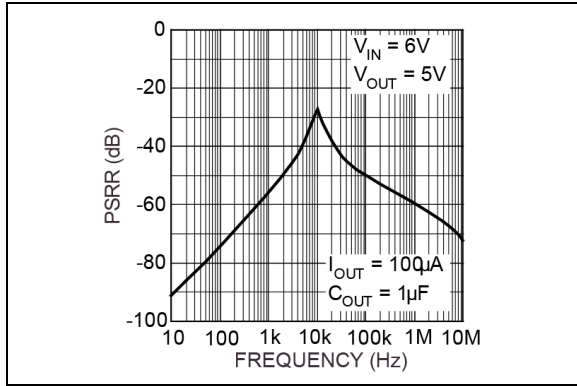
Parameters	Sym.	Min.	Typ.	Max.	Units	Conditions
<b>Temperature Ranges</b>						
Junction Operating Temperature Range	$T_J$	-40	—	+85	°C	—
Storage Temperature Range	$T_S$	-60	—	+150	°C	—
Lead Temperature	—	—	—	+260	°C	Soldering, 5s
<b>Package Thermal Resistances</b>						
Thermal Resistance MSOP-8	$\theta_{JA}$	—	200	—	°C/W	Note 2

- Note 1:** The maximum allowable power dissipation is a function of ambient temperature, the maximum allowable junction temperature and the thermal resistance from junction to air (i.e.,  $T_A$ ,  $T_J$ ,  $\theta_{JA}$ ). Exceeding the maximum allowable power dissipation will cause the device operating junction temperature to exceed the maximum +85°C rating. Sustained junction temperatures above +85°C can impact the device reliability.
- 2:** Absolute maximum ratings indicate limits beyond which damage to the component may occur. Electrical specifications do not apply when operating the device outside of its operating ratings. The maximum allowable power dissipation is a function of the maximum junction temperature,  $T_{J(max)}$ , the junction-to-ambient thermal resistance,  $\theta_{JA}$ , and the ambient temperature,  $T_A$ . The maximum allowable power dissipation at any ambient temperature is calculated using:  $P_{D(max)} = (T_{J(max)} - T_A) / \theta_{JA}$ . Exceeding the maximum allowable power dissipation will result in excessive die temperature, and the regulator will go into thermal shutdown. The  $\theta_{JA}$  of the 8-pin MSOP (MM) is 200°C/W mounted on a PC board (see “Thermal Considerations” section for further details).

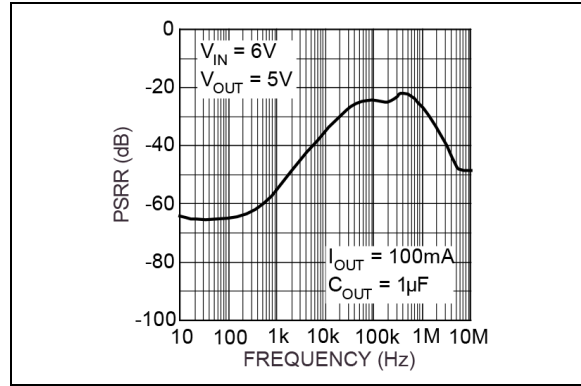
# MIC5210

## 2.0 TYPICAL PERFORMANCE CURVES

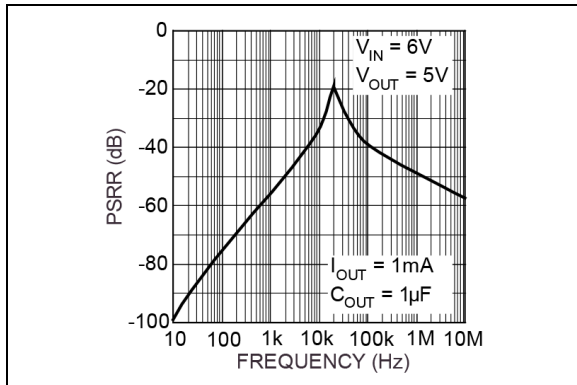
**Note:** The graphs and tables provided following this note are a statistical summary based on a limited number of samples and are provided for informational purposes only. The performance characteristics listed herein are not tested or guaranteed. In some graphs or tables, the data presented may be outside the specified operating range (e.g., outside specified power supply range) and therefore outside the warranted range.



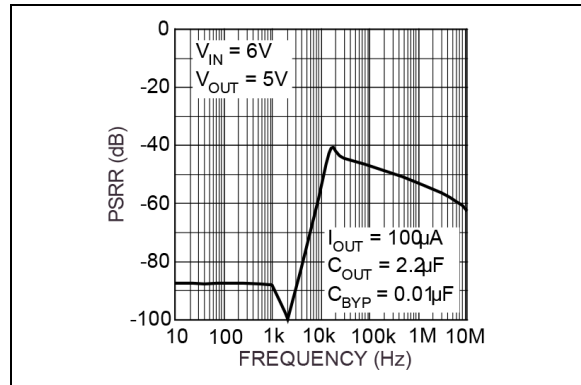
**FIGURE 2-1:** Power Supply Rejection Ratio.



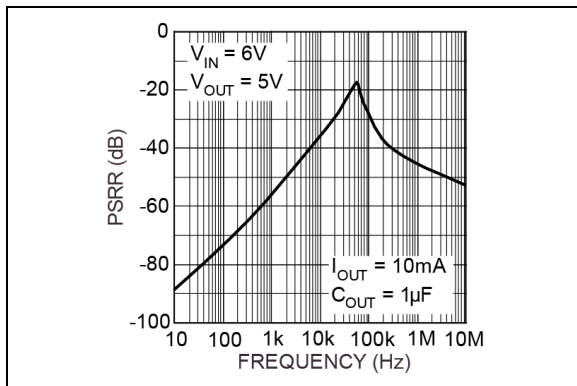
**FIGURE 2-4:** Power Supply Rejection Ratio.



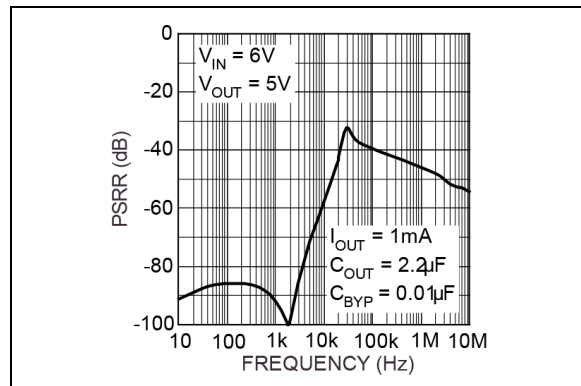
**FIGURE 2-2:** Power Supply Rejection Ratio.



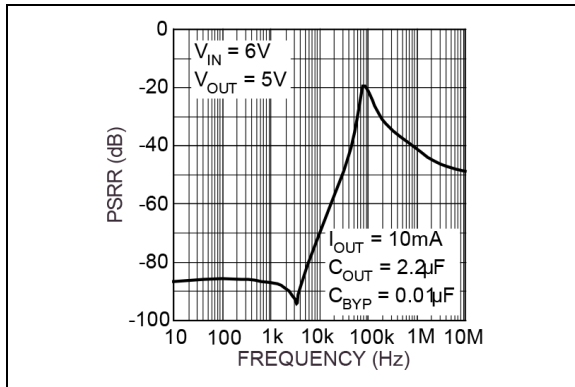
**FIGURE 2-5:** Power Supply Rejection Ratio.



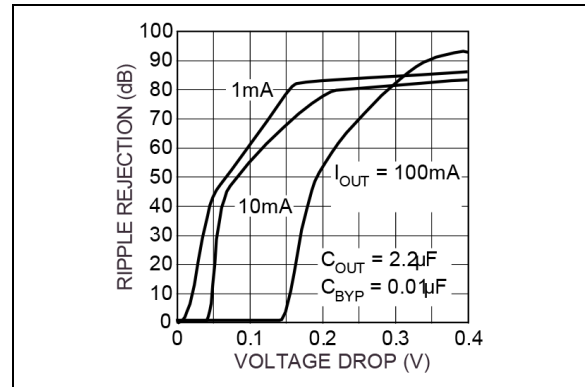
**FIGURE 2-3:** Power Supply Rejection Ratio.



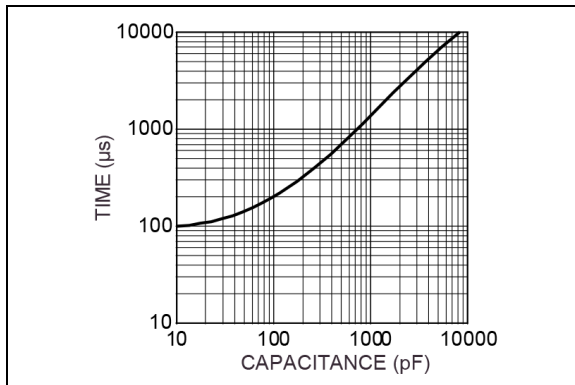
**FIGURE 2-6:** Power Supply Rejection Ratio.



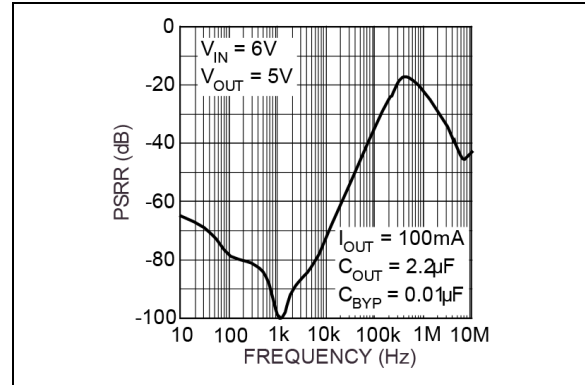
**FIGURE 2-7:** Power Supply Rejection Ratio.



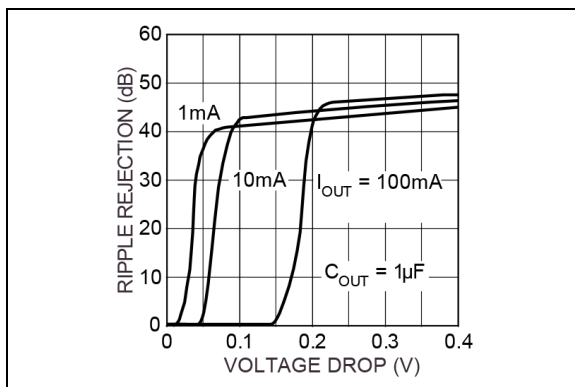
**FIGURE 2-10:** Power Supply Ripple Rejection vs. Voltage Drop.



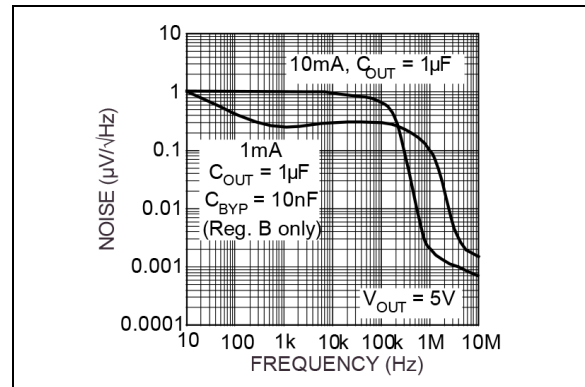
**FIGURE 2-8:** Turn-On Time vs. Bypass Capacitance.



**FIGURE 2-11:** Power Supply Rejection Ratio.

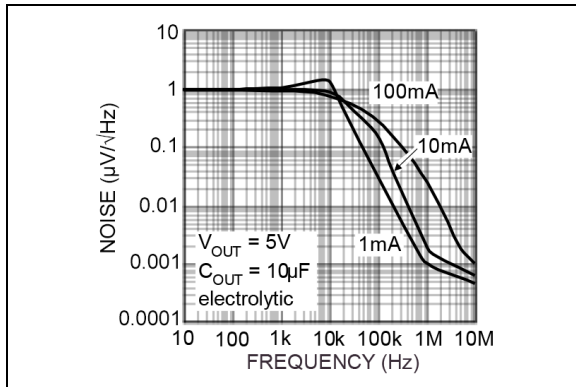


**FIGURE 2-9:** Power Supply Ripple Rejection vs. Voltage Drop.

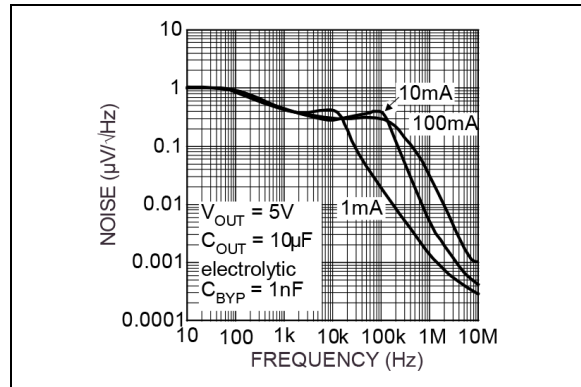


**FIGURE 2-12:** Noise Performance.

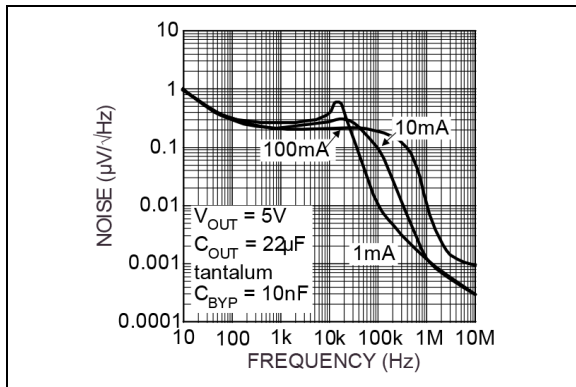
# MIC5210



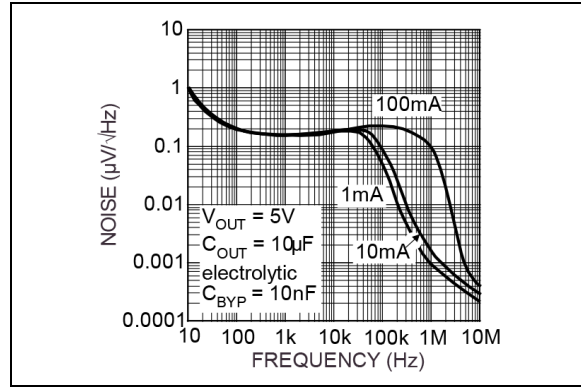
**FIGURE 2-13:** Noise Performance.



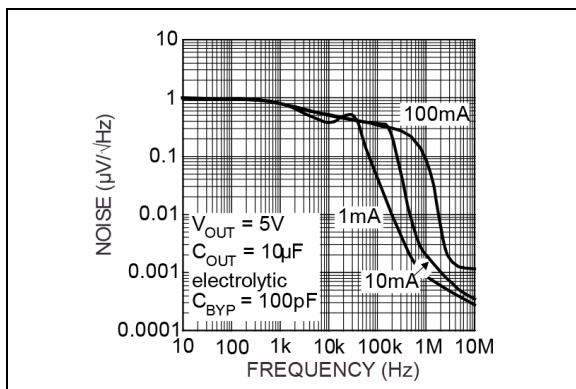
**FIGURE 2-16:** Noise Performance (Regulator B).



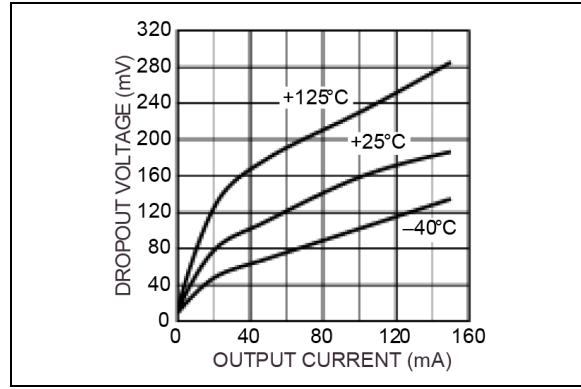
**FIGURE 2-14:** Noise Performance (Regulator B).



**FIGURE 2-17:** Noise Performance (Regulator B).



**FIGURE 2-15:** Noise Performance (Regulator B).



**FIGURE 2-18:** Dropout Voltage vs. Output Current.

## 3.0 PIN DESCRIPTIONS

The descriptions of the pins are listed in [Table 3-1](#).

**TABLE 3-1: PIN FUNCTION TABLE**

Pin Number	Pin Name	Description
1	OUTA	Regulator Output A
2	GND	Ground
3	OUTB	Regulator Output B
4	BYPB	Reference Bypass B: Connect external 470 pF capacitor to GND to reduce output noise in regulator "B". May be left open.
5	ENB	Enable/Shutdown B (Input): CMOS-compatible input. Logic-high = enable, logic-low = shutdown. Do not leave floating.
6	INB	Supply Input B
7	ENA	Enable/Shutdown A (Input): CMOS-compatible input. Logic-high = enable, logic-low = shutdown. Do not leave floating.
8	INA	Supply Input A

# MIC5210

## 4.0 APPLICATION INFORMATION

### 4.1 Enable/Shutdown

Forcing EN (enable/shutdown) high (greater than 2V) enables the regulator. EN is compatible with CMOS and TTL logic gates.

If the enable/shutdown feature is not required, connect EN to IN (supply input).

### 4.2 Input Capacitor

A 1  $\mu\text{F}$  capacitor should be placed from IN to GND if there is more than 10 inches of wire between the input and the AC filter capacitor or if a battery is used as the input.

### 4.3 Reference Bypass Capacitor

BYPB (reference bypass) is connected to the internal voltage reference of regulator B. A 470 pF capacitor ( $C_{\text{BYP}}$ ) connected from BYPB to GND quiets this reference, providing a significant reduction in output noise.  $C_{\text{BYP}}$  reduces the regulator phase margin; when using  $C_{\text{BYP}}$ , output capacitors of 2.2  $\mu\text{F}$  or greater are generally required to maintain stability.

The start-up speed of the MIC5210 is inversely proportional to the size of the reference bypass capacitor. Applications requiring a slow ramp-up of output voltage should consider larger values of  $C_{\text{BYP}}$ . Likewise, if rapid turn-on is necessary, consider omitting  $C_{\text{BYP}}$ .

If output noise is not a major concern, omit  $C_{\text{BYP}}$  and leave BYPB open.

### 4.4 Output Capacitor

An output capacitor is required between OUT and GND to prevent oscillation. The minimum size of the output capacitor is dependent upon whether a reference bypass capacitor is used. 1.0  $\mu\text{F}$  minimum is recommended when CBYP is not used. 2.2  $\mu\text{F}$  minimum is recommended when  $C_{\text{BYP}}$  is 470 pF (see [Typical Application Circuit](#)). Larger values improve the regulator's transient response. The output capacitor value may be increased without limit.

The output capacitor should have an ESR (effective series resistance) of about 5 $\Omega$  or less and a resonant frequency above 1 MHz. Ultralow-ESR capacitors may cause a low-amplitude oscillation and/or underdamped transient response. Most tantalum or aluminum electrolytic capacitors are adequate; film types will work, but are more expensive. Because many aluminum electrolytic capacitors have electrolytes that freeze at about  $-30^{\circ}\text{C}$ , solid tantalum capacitors are recommended for operation below  $-25^{\circ}\text{C}$ .

At lower values of output current, less output capacitance is required for output stability. The capacitor can be reduced to 0.47  $\mu\text{F}$  for current below 10 mA or 0.33  $\mu\text{F}$  for currents below 1 mA.

### 4.5 No-Load Stability

The MIC5210 will remain stable and in regulation with no load (other than the internal voltage divider) unlike many other voltage regulators. This is especially important in CMOS RAM keep-alive applications.

### 4.6 Dual-Supply Operation

When used in dual supply systems where the regulator load is returned to a negative supply, the output voltage must be diode clamped to ground.

### 4.7 Thermal Considerations

Multilayer boards having a ground plane, wide traces near the pads, and large supply bus lines provide better thermal conductivity.

The MIC5210-xxYMM (8-pin MSOP) has a thermal resistance of  $200^{\circ}\text{C}/\text{W}$  when mounted on a FR4 board with minimum trace widths and no ground plane.

For additional heat sink characteristics, please refer to [Application Hint 17, "Designing P.C. Board Heat Sinks."](#)

#### 4.7.1 THERMAL EVALUATION EXAMPLES

For example, at  $50^{\circ}\text{C}$  ambient temperature, the maximum package power dissipation is:

##### EQUATION 4-1:

$$P_{D(MAX)} = (125^{\circ}\text{C} - 50^{\circ}\text{C}) / (200^{\circ}\text{C}/\text{W}) = 375\text{mW}$$

If the intent is to operate the 5V version from a 6V supply at the full 150mA load for both outputs in a  $50^{\circ}\text{C}$  maximum ambient temperature, make the following calculation:

##### EQUATION 4-2:

$$P_{D(EACHREG)} = (V_{IN} - V_{OUT}) \times I_{OUT} + (V_{IN} \times I_{GND})$$

**EQUATION 4-3:**

$$\begin{aligned} P_{D(EACHREG)} &= (6V - 5V) \times 150mA + (6V \times 2.5mA) \\ &= 165mW \end{aligned}$$

**EQUATION 4-4:**

$$P_{D(BOTHREG)} = 2Regulators \times 165mW = 330mW$$

The actual total power dissipation of 330 mW is below the 375 mW package maximum; therefore, the regulator can be used.

Note that both regulators cannot always be used at their maximum current rating. For example, in a 5V input to 3.3V output application at +50°C, if one regulator supplies 150 mA, the other regulator is limited to a much lower current. The first regulator dissipates:

**EQUATION 4-5:**

$$\begin{aligned} P_D &= (5V - 3.3V) \times 150mA + (5V \times 2.5mA) \\ &= 267.5mW \end{aligned}$$

Then, the load that the remaining regulator can dissipate must not exceed 375 mW – 267.5 mW = 107.5 mW.

This means, using the same 5V input and 3.3V output voltage, the second regulator is limited to about 60 mA.

Taking advantage of the extremely low-dropout voltage characteristics of the MIC5210, power dissipation can be reduced by using the lowest possible input voltage to minimize the input-to-output voltage drop.

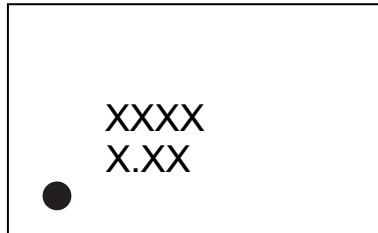
# MIC5210

---

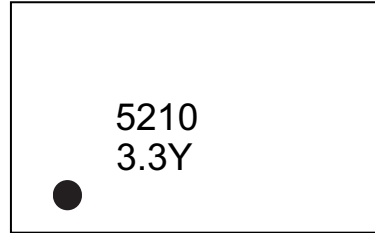
## 5.0 PACKAGING INFORMATION

### 5.1 Package Marking Information

8-Lead MSOP\*

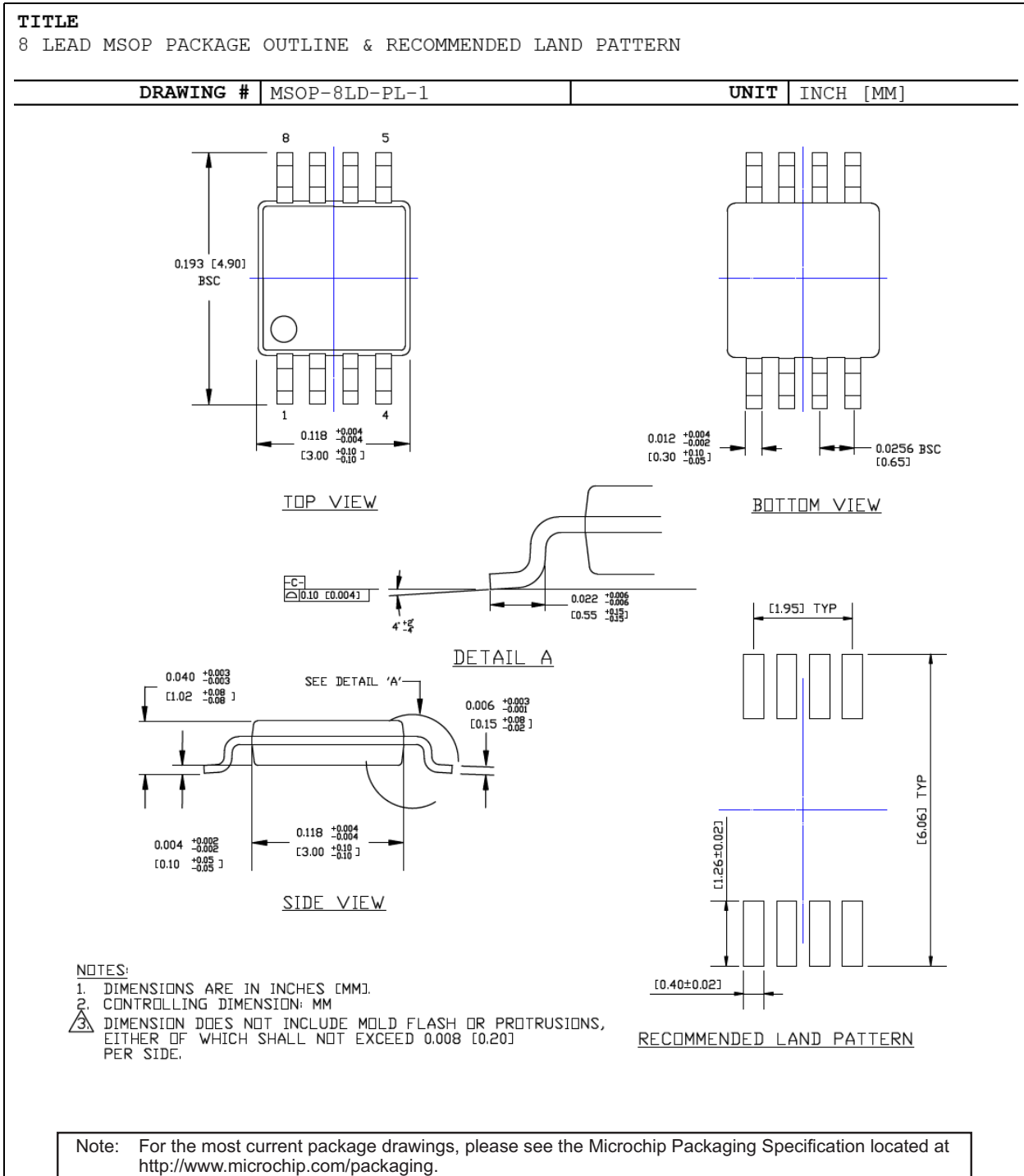


Example



<b>Legend:</b>	XX...X	Product code or customer-specific information
	Y	Year code (last digit of calendar year)
	YY	Year code (last 2 digits of calendar year)
	WW	Week code (week of January 1 is week '01')
	NNN	Alphanumeric traceability code
	(e3)	Pb-free JEDEC <sup>®</sup> designator for Matte Tin (Sn)
	*	This package is Pb-free. The Pb-free JEDEC designator ((e3)) can be found on the outer packaging for this package.
	•, ▲, ▼	Pin one index is identified by a dot, delta up, or delta down (triangle mark).
<b>Note:</b>	In the event the full Microchip part number cannot be marked on one line, it will be carried over to the next line, thus limiting the number of available characters for customer-specific information. Package may or may not include the corporate logo.	
	Underbar (¯) and/or Overbar (¯) symbol may not be to scale.	

## 8-Lead MSOP Package Outline and Recommended Land Pattern



# MIC5210

---

NOTES:

## APPENDIX A: REVISION HISTORY

### Revision A (March 2019)

- Converted Micrel document MIC5210 to Microchip data sheet DS20006096A.
- Minor text changes throughout.

# MIC5210

---

NOTES:

## PRODUCT IDENTIFICATION SYSTEM

To order or obtain information, e.g., on pricing or delivery, contact your local Microchip representative or sales office.

<u>PART NO.</u>	<u>-X.X</u>	<u>X</u>	<u>XX</u>	<u>-XX</u>
Device	Voltage	Temperature	Package	Media Type
<b>Device:</b>	MIC5210:		Dual 150 mA LDO Regulator	
<b>Voltage:</b>	2.8 = 2.8V 3.0 = 3.0V 3.3 = 3.3V 5.0 = 5.0V			
<b>Temperature:</b>	Y = -40°C to +125°C			
<b>Package:</b>	MM = 8-Lead MSOP			
<b>Media Type:</b>	<blank>= 100/Tube TR = 2,500/Reel			

<b>Examples:</b>	
a) MIC5210-2.8YMM:	Dual 150 mA LDO Regulator, 2.8V, -40°C to +125°C, 8-Lead MSOP, 100/Tube
b) MIC5210-3.0YMM:	Dual 150 mA LDO Regulator, 3.0V, -40°C to +125°C, 8-Lead MSOP, 100/Tube
c) MIC5210-3.3YMM:	Dual 150 mA LDO Regulator, 3.3V, -40°C to +125°C, 8-Lead MSOP, 100/Tube
d) MIC5210-5.0YMM:	Dual 150 mA LDO Regulator, 5.0V, -40°C to +125°C, 8-Lead MSOP, 100/Tube
e) MIC5210-2.8YMM-TR:	Dual 150 mA LDO Regulator, 2.8V, -40°C to +125°C, 8-Lead MSOP, 2,500/Reel
f) MIC5210-3.0YMM-TR:	Dual 150 mA LDO Regulator, 3.0V, -40°C to +125°C, 8-Lead MSOP, 2,500/Reel
g) MIC5210-3.3YMM-TR:	Dual 150 mA LDO Regulator, 3.3V, -40°C to +125°C, 8-Lead MSOP, 2,500/Reel
h) MIC5210-5.0YMM-TR:	Dual 150 mA LDO Regulator, 5.0V, -40°C to +125°C, 8-Lead MSOP, 2,500/Reel

**Note 1:** Tape and Reel identifier only appears in the catalog part number description. This identifier is used for ordering purposes and is not printed on the device package. Check with your Microchip Sales Office for package availability with the Tape and Reel option.

# MIC5210

---

NOTES:

---

---

**Note the following details of the code protection feature on Microchip devices:**

- Microchip products meet the specification contained in their particular Microchip Data Sheet.
- Microchip believes that its family of products is one of the most secure families of its kind on the market today, when used in the intended manner and under normal conditions.
- There are dishonest and possibly illegal methods used to breach the code protection feature. All of these methods, to our knowledge, require using the Microchip products in a manner outside the operating specifications contained in Microchip's Data Sheets. Most likely, the person doing so is engaged in theft of intellectual property.
- Microchip is willing to work with the customer who is concerned about the integrity of their code.
- Neither Microchip nor any other semiconductor manufacturer can guarantee the security of their code. Code protection does not mean that we are guaranteeing the product as “unbreakable.”

Code protection is constantly evolving. We at Microchip are committed to continuously improving the code protection features of our products. Attempts to break Microchip's code protection feature may be a violation of the Digital Millennium Copyright Act. If such acts allow unauthorized access to your software or other copyrighted work, you may have a right to sue for relief under that Act.

---

Information contained in this publication regarding device applications and the like is provided only for your convenience and may be superseded by updates. It is your responsibility to ensure that your application meets with your specifications. MICROCHIP MAKES NO REPRESENTATIONS OR WARRANTIES OF ANY KIND WHETHER EXPRESS OR IMPLIED, WRITTEN OR ORAL, STATUTORY OR OTHERWISE, RELATED TO THE INFORMATION, INCLUDING BUT NOT LIMITED TO ITS CONDITION, QUALITY, PERFORMANCE, MERCHANTABILITY OR FITNESS FOR PURPOSE. Microchip disclaims all liability arising from this information and its use. Use of Microchip devices in life support and/or safety applications is entirely at the buyer's risk, and the buyer agrees to defend, indemnify and hold harmless Microchip from any and all damages, claims, suits, or expenses resulting from such use. No licenses are conveyed, implicitly or otherwise, under any Microchip intellectual property rights unless otherwise stated.

*Microchip received ISO/TS-16949:2009 certification for its worldwide headquarters, design and wafer fabrication facilities in Chandler and Tempe, Arizona; Gresham, Oregon and design centers in California and India. The Company's quality system processes and procedures are for its PIC® MCUs and dsPIC® DSCs, KEELOQ® code hopping devices, Serial EEPROMs, microperipherals, nonvolatile memory and analog products. In addition, Microchip's quality system for the design and manufacture of development systems is ISO 9001:2000 certified.*

**QUALITY MANAGEMENT SYSTEM  
CERTIFIED BY DNV  
= ISO/TS 16949 =**

### **Trademarks**

The Microchip name and logo, the Microchip logo, AnyRate, AVR, AVR logo, AVR Freaks, BitCloud, chipKIT, chipKIT logo, CryptoMemory, CryptoRF, dsPIC, FlashFlex, flexPWR, Heldo, JukeBlox, KeeLoq, Kleer, LANCheck, LINK MD, maXStylus, maXTouch, MediaLB, megaAVR, MOST, MOST logo, MPLAB, OptoLyzer, PIC, picoPower, PICSTART, PIC32 logo, Prochip Designer, QTouch, SAM-BA, SpyNIC, SST, SST Logo, SuperFlash, tinyAVR, UNI/O, and XMEGA are registered trademarks of Microchip Technology Incorporated in the U.S.A. and other countries.

ClockWorks, The Embedded Control Solutions Company, EtherSynch, Hyper Speed Control, HyperLight Load, IntellIMOS, mTouch, Precision Edge, and Quiet-Wire are registered trademarks of Microchip Technology Incorporated in the U.S.A.

Adjacent Key Suppression, AKS, Analog-for-the-Digital Age, Any Capacitor, AnyIn, AnyOut, BodyCom, CodeGuard, CryptoAuthentication, CryptoAutomotive, CryptoCompanion, CryptoController, dsPICDEM, dsPICDEM.net, Dynamic Average Matching, DAM, ECAN, EtherGREEN, In-Circuit Serial Programming, ICSP, INICnet, Inter-Chip Connectivity, JitterBlocker, KleerNet, KleerNet logo, memBrain, Mindi, MiWi, motorBench, MPASM, MPF, MPLAB Certified logo, MPLIB, MPLINK, MultiTRAK, NetDetach, Omniscient Code Generation, PICDEM, PICDEM.net, PICKit, PICtail, PowerSmart, PureSilicon, QMatrix, REAL ICE, Ripple Blocker, SAM-ICE, Serial Quad I/O, SMART-I.S., SQI, SuperSwitcher, SuperSwitcher II, Total Endurance, TSHARC, USBCheck, VariSense, ViewSpan, WiperLock, Wireless DNA, and ZENA are trademarks of Microchip Technology Incorporated in the U.S.A. and other countries.

SQTP is a service mark of Microchip Technology Incorporated in the U.S.A.

Silicon Storage Technology is a registered trademark of Microchip Technology Inc. in other countries.

GestIC is a registered trademark of Microchip Technology Germany II GmbH & Co. KG, a subsidiary of Microchip Technology Inc., in other countries.

All other trademarks mentioned herein are property of their respective companies.

© 2019, Microchip Technology Incorporated, All Rights Reserved.  
ISBN: 978-1-5224-4272-1



# MICROCHIP

## Worldwide Sales and Service

### AMERICAS

**Corporate Office**  
2355 West Chandler Blvd.  
Chandler, AZ 85224-6199  
Tel: 480-792-7200  
Fax: 480-792-7277  
Technical Support:  
<http://www.microchip.com/support>  
Web Address:  
[www.microchip.com](http://www.microchip.com)

#### Atlanta

Duluth, GA  
Tel: 678-957-9614  
Fax: 678-957-1455

#### Austin, TX

Tel: 512-257-3370

#### Boston

Westborough, MA  
Tel: 774-760-0087  
Fax: 774-760-0088

#### Chicago

Itasca, IL  
Tel: 630-285-0071  
Fax: 630-285-0075

#### Dallas

Addison, TX  
Tel: 972-818-7423  
Fax: 972-818-2924

#### Detroit

Novi, MI  
Tel: 248-848-4000

#### Houston, TX

Tel: 281-894-5983

#### Indianapolis

Noblesville, IN  
Tel: 317-773-8323  
Fax: 317-773-5453  
Tel: 317-536-2380

#### Los Angeles

Mission Viejo, CA  
Tel: 949-462-9523  
Fax: 949-462-9608  
Tel: 951-273-7800

#### Raleigh, NC

Tel: 919-844-7510

#### New York, NY

Tel: 631-435-6000

#### San Jose, CA

Tel: 408-735-9110  
Tel: 408-436-4270

#### Canada - Toronto

Tel: 905-695-1980  
Fax: 905-695-2078

### ASIA/PACIFIC

**Australia - Sydney**  
Tel: 61-2-9868-6733

**China - Beijing**  
Tel: 86-10-8569-7000

**China - Chengdu**  
Tel: 86-28-8665-5511

**China - Chongqing**  
Tel: 86-23-8980-9588

**China - Dongguan**  
Tel: 86-769-8702-9880

**China - Guangzhou**  
Tel: 86-20-8755-8029

**China - Hangzhou**  
Tel: 86-571-8792-8115

**China - Hong Kong SAR**  
Tel: 852-2943-5100

**China - Nanjing**  
Tel: 86-25-8473-2460

**China - Qingdao**  
Tel: 86-532-8502-7355

**China - Shanghai**  
Tel: 86-21-3326-8000

**China - Shenyang**  
Tel: 86-24-2334-2829

**China - Shenzhen**  
Tel: 86-755-8864-2200

**China - Suzhou**  
Tel: 86-186-6233-1526

**China - Wuhan**  
Tel: 86-27-5980-5300

**China - Xian**  
Tel: 86-29-8833-7252

**China - Xiamen**  
Tel: 86-592-2388138

**China - Zhuhai**  
Tel: 86-756-3210040

### ASIA/PACIFIC

**India - Bangalore**  
Tel: 91-80-3090-4444

**India - New Delhi**  
Tel: 91-11-4160-8631

**India - Pune**  
Tel: 91-20-4121-0141

**Japan - Osaka**  
Tel: 81-6-6152-7160

**Japan - Tokyo**  
Tel: 81-3-6880-3770

**Korea - Daegu**  
Tel: 82-53-744-4301

**Korea - Seoul**  
Tel: 82-2-554-7200

**Malaysia - Kuala Lumpur**  
Tel: 60-3-7651-7906

**Malaysia - Penang**  
Tel: 60-4-227-8870

**Philippines - Manila**  
Tel: 63-2-634-9065

**Singapore**  
Tel: 65-6334-8870

**Taiwan - Hsin Chu**  
Tel: 886-3-577-8366

**Taiwan - Kaohsiung**  
Tel: 886-7-213-7830

**Taiwan - Taipei**  
Tel: 886-2-2508-8600

**Thailand - Bangkok**  
Tel: 66-2-694-1351

**Vietnam - Ho Chi Minh**  
Tel: 84-28-5448-2100

### EUROPE

**Austria - Wels**  
Tel: 43-7242-2244-39  
Fax: 43-7242-2244-393

**Denmark - Copenhagen**  
Tel: 45-4450-2828  
Fax: 45-4485-2829

**Finland - Espoo**  
Tel: 358-9-4520-820

**France - Paris**  
Tel: 33-1-69-53-63-20  
Fax: 33-1-69-30-90-79

**Germany - Garching**  
Tel: 49-8931-9700

**Germany - Haan**  
Tel: 49-2129-3766400

**Germany - Heilbronn**  
Tel: 49-7131-67-3636

**Germany - Karlsruhe**  
Tel: 49-721-625370

**Germany - Munich**  
Tel: 49-89-627-144-0  
Fax: 49-89-627-144-44

**Germany - Rosenheim**  
Tel: 49-8031-354-560

**Israel - Ra'anana**  
Tel: 972-9-744-7705

**Italy - Milan**  
Tel: 39-0331-742611  
Fax: 39-0331-466781

**Italy - Padova**  
Tel: 39-049-7625286

**Netherlands - Drunen**  
Tel: 31-416-690399  
Fax: 31-416-690340

**Norway - Trondheim**  
Tel: 47-7288-4388

**Poland - Warsaw**  
Tel: 48-22-3325737

**Romania - Bucharest**  
Tel: 40-21-407-87-50

**Spain - Madrid**  
Tel: 34-91-708-08-90  
Fax: 34-91-708-08-91

**Sweden - Gothenberg**  
Tel: 46-31-704-60-40

**Sweden - Stockholm**  
Tel: 46-8-5090-4654

**UK - Wokingham**  
Tel: 44-118-921-5800  
Fax: 44-118-921-5820

## Looking for pricing, stock, or lifecycle information?

Click below to explore more details on WIN SOURCE:

- ⊖ [View MIC5210-5.0BMMTR on WIN SOURCE](#)
- ⊖ [Microchip Technology Information](#)

## Optimize Your Supply Chain with WIN SOURCE Solutions

- ✓ Global Sourcing Solution
- ✓ Obsolete Management
- ✓ Cost Control Management
- ✓ Shortage Management
- ✓ Alternative Solution
- ✓ Excess Inventory Management